

Canon

IXUS Z70 MRC

02/23-361  
**E**

**F**

**G**

**ELPH 370Z** **I**

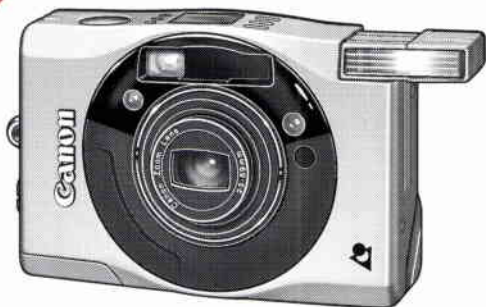

**E** English

**F** Français

**G** Deutsch

**I** Italiano



## Handling Precautions

1. This camera is not resistant to water, and should not be used outdoors if it is raining or snowing. If it is accidentally dropped in water, contact an authorized Canon service facility. Keep the camera out of salt spray and excessive humidity. If used at the beach, clean it thoroughly afterward with a dry cloth.
2. Store the camera in a cool, dry, dust-free place. Be sure to keep the camera out of direct sunlight, and away from "hot spots" such as the trunk or rear window shelf of a car. Avoid places where mothballs are used, and use a desiccant in excessive humidity.
3. Do not attempt to disassemble the camera yourself, since there is high-voltage circuitry inside.
4. The battery may explode or cause burns if disassembled, recharged, shorted, exposed to high temperatures, or disposed of in a fire.
5. Use a blower brush to remove dust and sand from the lens and inside the camera. Do not apply any fluids to the lens or body. Take the camera to an authorized Canon service facility for a more thorough cleaning if necessary.
6. Film passing through X-ray examinations at an airport may be exposed and ruined even when loaded in the camera. Request a different method of inspection to avoid damage.
7. Color reproduction may be adversely affected if the film is left in the camera for a long time. Always develop exposed film promptly.

If you use the flash continuously (30 times or more) while no film is in the camera, the camera may stop to prevent the flash unit from overheating. If this happens, turn the camera off and wait a few minutes before turning it back on again.

This device complies with Part 15 of the FCC Rules. Operation is subject to the following two conditions: (1) This device may not cause harmful interference, and (2) this device must accept any interference received, including interference that may cause undesired operation.

Do not make any changes or modifications to the equipment unless otherwise specified in the instructions. If such changes or modifications should be made, you could be required to stop operation of the equipment.

This equipment has been tested and found to comply with the limits for a class B digital device, pursuant to part 15 of the FCC Rules. These limits are designed to provide reasonable protection against harmful interference in a residential installation. This equipment generates, uses and can radiate radio frequency energy and, if not installed and used in accordance with the instructions, may cause harmful interference to radio communications.

However, there is no guarantee that interference will not occur in a particular installation. If this equipment does cause harmful interference to radio or television reception, which can be determined by turning the equipment off and on, the user is encouraged to try to correct the interference by one or more of the following measures:

- Reorient or relocate the receiving antenna.
- Increase the separation between the equipment and receiver.
- Consult the dealer or an experienced radio/TV technician for help.

---

This digital apparatus does not exceed the Class B limits for radio noise emissions from digital apparatus as set out in the interference-causing equipment standard entitled "Digital Apparatus", ICES-003 of the Industry Canada.

---

Cet appareil numérique respecte les limites de bruits radioélectriques applicables aux appareils numériques de Classe B prescrites dans la norme sur le matériel brouilleur: "Appareils Numériques", NMB-003 édictée par l'Industrie Canada.

---



The CE Mark is a Directive conformity mark of the European Community (EC)

**Thank you for purchasing this Canon product.**  
Before taking pictures, please read these instructions carefully for a thorough understanding of how the camera operates.

## Table of Contents

These instructions are divided into four sections: Introduction, Basic Operations, Advanced Operations, and Additional Information. When first using the camera, be sure to read the instructions from the Introduction.

### Convention

The following convention is used in these instructions:



Warnings you should observe when using the camera.



Additional information on using the camera.

<b>1</b>	<b>Introduction</b>	
	Handling Precautions .....	2
	Table of Contents .....	4
	ADVANCED PHOTO SYSTEM Features .....	6
	Advanced Photo System Quick Reference .....	8
	Quick Reference .....	10
	Nomenclature .....	12
	Attaching the Strap .....	14
<b>2</b>	<b>Basic Operations</b>	
	① Loading the Battery .....	15
	② Loading the Film Cartridge .....	16
	Checking the Film Speed and the Maximum Number of Frames .....	18
	③ Turning the Power On .....	19
	Checking the Battery Power .....	20
	④ Holding the Camera .....	21
	⑤ Viewfinder .....	22
	Parallax Compensation for Close-ups .....	23

6	Selecting the Print Type (C/H/P) .....	24
7	Zoom Operation .....	25
8	Shutter Button Action .....	26
	Green/Orange Indicators .....	27
9	Removing the Film Cartridge .....	28
	Film Cartridge Processing.....	29
	Handling Film Cartridges After Exposure .....	29

**E**

### **3** **Advanced Operations**

Changing the Flash Mode	.....	30
Auto Flash Mode without Red-eye Reduction.....		31
Auto Flash Mode with Red-eye Reduction	.....	32
Red-eye Reduction Function .....		33
Flash ON Mode	.....	34
Flash OFF Mode	.....	35
Slow-synchro Mode with Red-eye Reduction	.....	36
Focus Lock.....		37
Real Time Release Mode.....		38
AiAF (Smart AF) Function.....		40
Shooting Through a Window .....		40
Self-timer Shooting	.....	41
Shooting with the Optional Remote Control	.....	42
Replacing the Remote Control Battery .....		43
Date and Time Imprinting .....		44
Changing the Date Format .....		45
Setting and Adjusting the Date/Time .....		46
Imprinting Titles .....		48
Selecting the Title Language .....		48
Selecting the Title.....		49
Mid-roll Film Change	.....	50
Reloading a Partially Exposed Film Cartridge.....		51
Setting the Print Quantity	.....	52

**1**

**2**

**3**

**4**

### **4** **Additional Information**

Troubleshooting .....	54
Questions and Answers .....	55
Specifications .....	56



## ADVANCED PHOTO SYSTEM

This camera supports the new Advanced Photo System. This system, as well as Canon's advanced technology has made it possible to produce a camera that is smaller than any previous camera with a 3x zoom lens.

Here are some of the special features of this system.

### 1 New Film

The IX240 new film comes in a compact film cartridge with no leader. This new drop-in film can be easily loaded by anyone, and replaces all previous hard-to-load films.

In addition, the visual exposure indicator on the top of the cartridge shows whether the film cartridge is unexposed, partial, exposed, or processed.

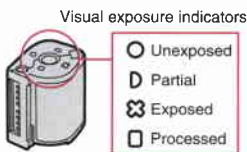

### 2 Mid-roll Film Change

If a partially exposed film cartridge is reloaded in the camera, the camera automatically advances the film to the next unexposed frame. You can then continue taking pictures until the film cartridge is fully exposed. This allows you to use separate film cartridges for different types of subjects, or moods.

\*If a partially exposed film cartridge is loaded into in a camera that does not support mid-roll film change, the camera will set the visual exposure indicator to "Exposed" and will not load the film. Be sure to check the features of each camera.

## Features

### 3 New Type Prints

The Advanced Photo System allows the camera to shoot three types of prints: in addition to classic print types (C print), you can now shoot wide-angle (H print) and panorama (P print) prints.

The Advanced Photo System can also imprint date/time information on the back of the print, or on the front and back of the print. The system can also imprint title text on the back of the print.

\*Character size, shape, color, position, and ability to print on both sides may vary according to the individual photo shop.

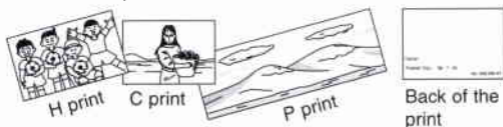

### 4 New Processing Methods

Previous 135 (35mm) film has always been returned from the processing lab as negative strips. This has made ordering reprints inconvenient since each picture must be found on the negative strips. With the Advanced Photo System however, the negative film is returned from the certified shop reloaded in its cartridge, accompanied by an index print. Unlike hard-to-see negative strips of previous cameras, this index print (where all shots can be viewed) makes reviewing prints much easier. Users can now order reprints simply by matching the ID on the back of the print or on the index print with the ID on the film cartridge, and then specifying the print number to be reprinted at the photo shop.

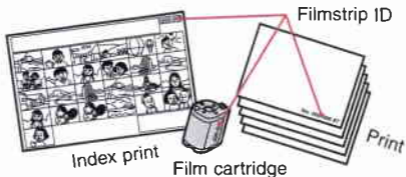

## Advanced Photo System Quick Reference

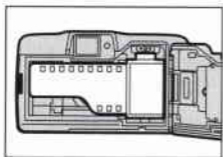

Previous film

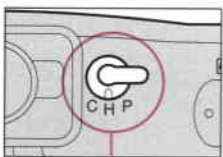
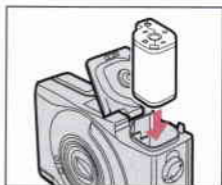

Print type selection lever



C print



H print



P print

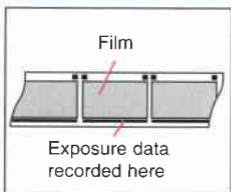

Data recorded on film  
(example)

- Date and title
- Print type
- Print quantity
- Flash ON/OFF
- Subject brightness
- Etc.

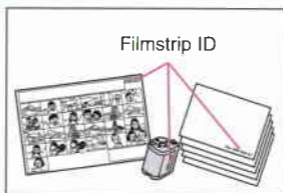



For further details, refer to the page indicated.

## **1 Simple film cartridge loading. (→ 16)**

- Unlike previous 135 (35mm) film, there is no need to open the back cover and pull the film leader across.

**E**

## **2 Choose the print type with the print type selection lever. (→ 24)**

- You can choose from three print types.
- C print: Classic print
  - H print: Wide-angle print
  - P print: Panorama print

## **3 A variety of data (IX information) is recorded magnetically on the film surface.**

- All the information described at left can be recorded on the film.
- The exposure information is used in the printing process to produce better quality prints.

**1**

## **4 Exposed film cartridges can be processed for printing at Advanced Photo System certified shops. (→ 29)**

- After developing, the shop will return your pictures, along with an index print, and the film cartridge with the film inside.
- When ordering reprints from a certified shop, just match the ID on the back of the print or on the index print sheet with the ID on the film cartridge, and specify which prints you want.

## Quick Reference

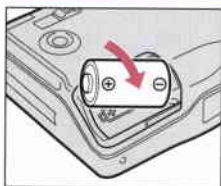

**1** Load the battery. (→ 15)

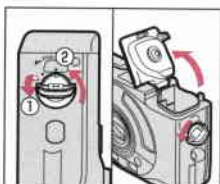

**2** Open the film cartridge compartment cover. (→ 16)

- To open, lift the crank ① and rotate left ②.

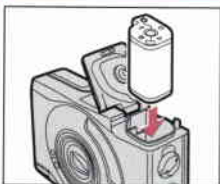

**3** Insert the film cartridge and close the film cartridge compartment cover. (→ 16)

- Check that the visual exposure indicator is ○ (unexposed), or ◐ (partial).

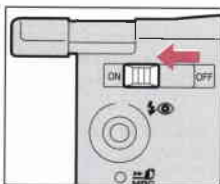

**4** Slide the main switch to the ON position to turn the camera on. (→ 19)

- ➔ The lens and flash are set for shooting.

For further details, refer to the page indicated.

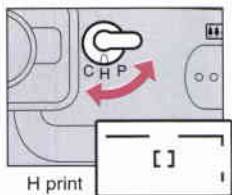

**5** Select the print type with the print type selection lever. (→ 24)

➔ The viewfinder field changes.

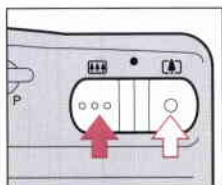

**6** Press the zoom buttons to change the subject size as desired. (→ 25)

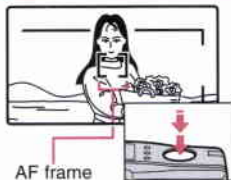

**7** Place the AF frame over the subject and press the shutter button.

(→ 26)

➔ The flash fires automatically in low light or backlit conditions.

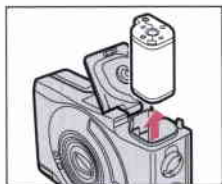

**8** When the film cartridge has finished and the film has rewound, remove the cartridge from the camera. (→ 28)

• Check that  on the LCD panel is blinking then open the film cartridge compartment cover.

E

1

## Nomenclature

\* (→ ■) is shorthand for "See page ■".

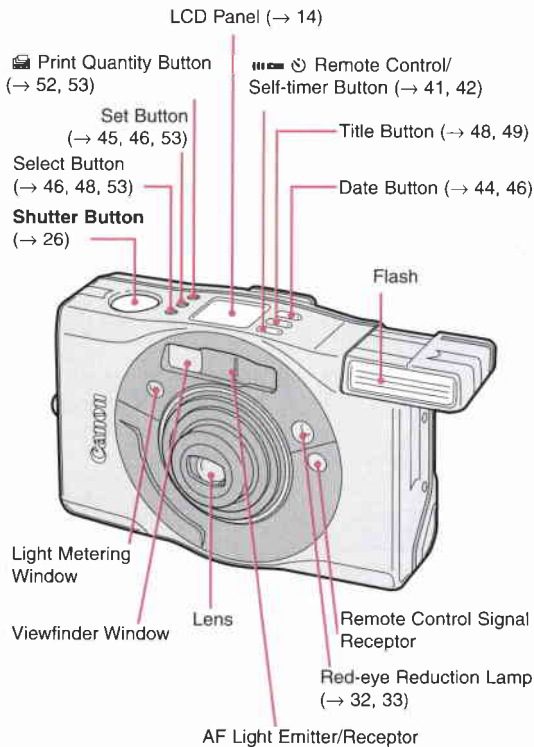

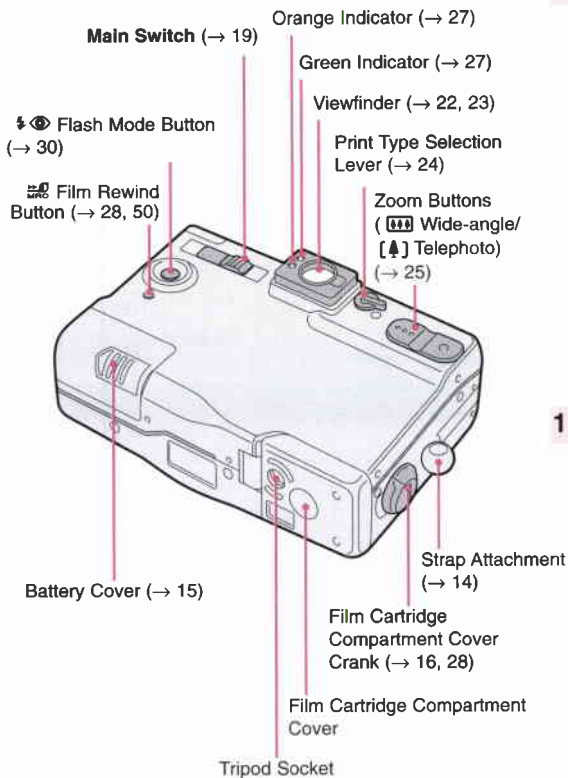

## Nomenclature/Attaching the Strap

### LCD Panel

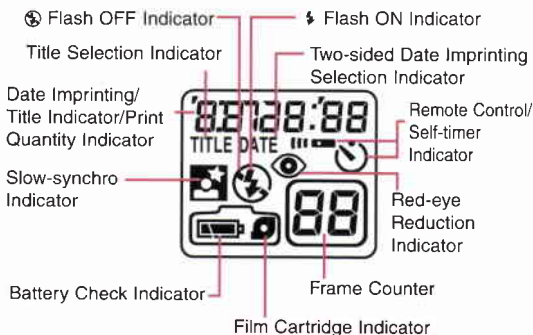

Only the necessary indicators will be displayed on the LCD panel.

### Attaching the Strap

Before using your camera, attach the strap provided. Be careful not to drop the camera.

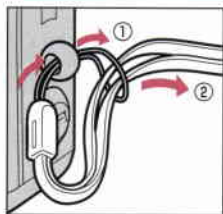

**Pass the strap through the strap attachment on the left side of the camera.**

• Follow step ① before step ②.

• Use the push-button projection to press the Select (→ 46), Set (→ 45), print quantity button (→ 52) and the film rewind buttons (→ 28).

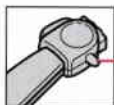

Push-button projection

## 1 Loading the Battery

Battery: One lithium battery (CR2)

E

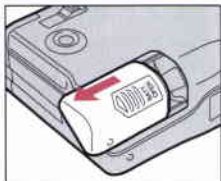

### 1 Open the battery cover.

- While pressing the  mark on the battery cover, slide the battery cover off.

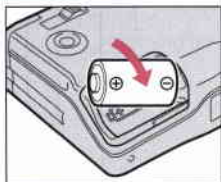

### 2 Load the new battery.

- Insert the battery with the + and - terminals positioned correctly.
- ➔  is displayed on the LCD panel.

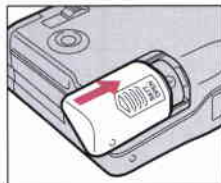

### 3 Close the battery cover.

- Slide the battery cover closed.
- ➔ If "-- -- --" blinks in the LCD panel, after you change the battery, you will need to reset the date to the correct date and time (→ 46).

1

2



- After removing the battery to replace it, do not touch any of the switches on the camera. This will allow the date and time settings to be retained for approximately five seconds.

## 2 Loading the Film Cartridge

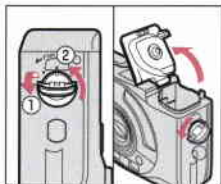

### 1 Open the film cartridge compartment cover.

- Lift the film cartridge compartment cover crank ① and rotate left ② to open the cover on the bottom of the camera.

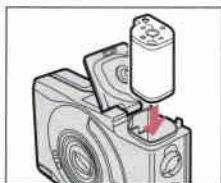

### 2 Load a film cartridge.

- Load with the visual exposure indicator end facing outwards.

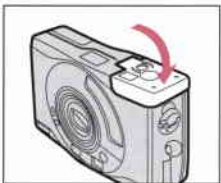

### 3 Close the film cartridge compartment cover.

- Close until it clicks.
- ➔  on the LCD panel lights up.



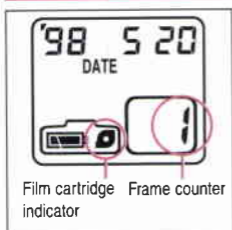

Film cartridge indicator    Frame counter indicator

## 4 The film automatically advances to the first frame and "1" is displayed in the frame counter.

- If "1" is not displayed, check if the film cartridge is loaded correctly.
- When a film cartridge whose visual exposure indicator is  $\text{D}$  (partial), is loaded, the camera automatically advances the film to the first unexposed frame. The number for the next unexposed frame is shown in the frame counter.

### Film cartridges

- Use IX240 film cartridge.
- Previous 135 (35mm) print film cannot be used.
- Use film cartridges whose visual exposure indicator is  $\text{O}$  (unexposed), or  $\text{D}$  (partial).

$\text{O}$  (unexposed)

$\text{D}$  (partial)



- If  $\text{X}$  (exposed) or  $\square$  (processed) film cartridges are loaded, "0" in the frame counter and  $\blacksquare$  will blink. Reload with a  $\text{O}$  (unexposed) or  $\text{D}$  (partial) film cartridge.

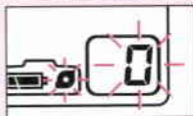

### Checking the Film Speed and the Maximum Number of Frames

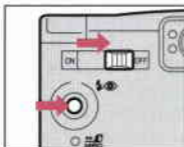

- Turn the power off, then press the ⚡👁 flash mode button.

➔ The film speed appears in the date display area, and the frame counter displays the maximum number of frames.

(The illustration on the left shows ISO 200 as the film speed and 25 as the maximum number of frames.)



### 3 Turning the Power On

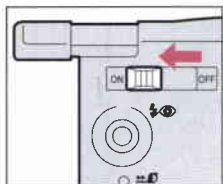

**Slide the main switch to the ON position.**

- ➔ The lens and flash are set for shooting.
- ➔ The flash mode is set to auto flash (full auto mode).



- Do not press on the lens.
- Be careful not to push the flash into the camera while shooting. The flash will not fire and the power to the camera will be turned off.



- The lens first sets to the wide-angle (23mm) position.

### Turning the power off



**Slide the main switch to the OFF position.**

## Turning the Power On



### Checking the Battery Power

Check that  is displayed on the LCD panel when the power is turned on.

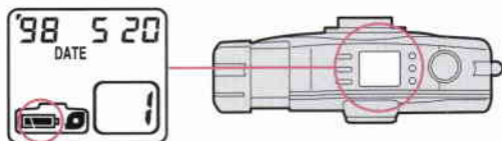
Shooting capacity with a new battery – Approx. 8 film cartridges of 25 exposures with 50% flash use. (Data based on Canon's Standard Test Method.)



### Battery Check Indicator

-  (Lit): Battery is full
-  (Lit): Have a new battery ready
-  (Blinks): Replace the battery (→ 15)



- Use one lithium battery (CR2).
- Before shooting, be sure to check the battery power.
- When traveling or planning to take many pictures, be sure to take a supply of spare batteries, they may not be available where you are.
- Shooting continuously with the flash will cause the battery power to fall momentarily, and the LCD panel display may be incorrect. Turn the power off and wait a while before turning it back on.

## 4 Holding the Camera

To take sharp pictures, hold the camera firmly so that it does not move.



- Hold the camera with both hands.
- Keep your elbows close to your body.
- Hold the camera against your nose and look through the viewfinder.



- Be careful to keep hair and fingers from blocking the lens, AF light emitter/receptor, light metering window, and flash.
- Be careful not to press the flash all the way into the camera. This will turn the power off.
- Dirt or foreign substances on the AF light emitter/receptor make it harder to focus. Be sure to keep the front of the camera clean.

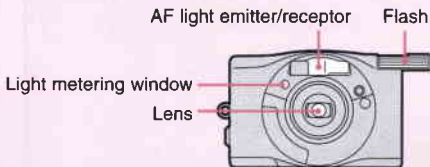

## 5 Viewfinder

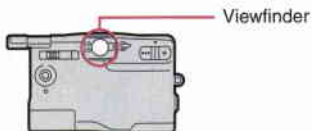

### Viewfinder Frames

#### Picture Frame

Compose your picture within this frame.  
(H print)

#### Close-up frame

When the shooting distance is between 0.6 and 1 m (2 and 3.3 ft.) compose your picture within this frame. The area outside this frame will not be taken. (H print)

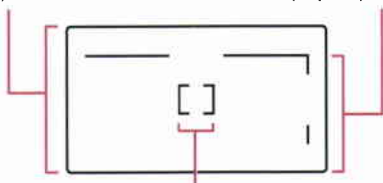

#### AF Frame

Place this frame over the subject you wish to take.

## Parallax Compensation for Close-ups

When taking photographs of subjects as close as 0.6 to 1 m (2 to 3.3 ft.) to the camera, the camera will cut off the top portion of the picture that is visible in the picture frame. This is called parallax displacement.

To take pictures of subjects at 0.6 to 1 m, follow the steps below to use the picture frame to compose the picture.

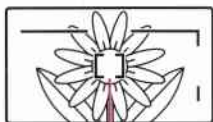

AF frame

### 1 Position the AF frame over the subject and press the shutter button halfway.

- Check that the green indicator is lit.
- Keep the shutter button pressed halfway.



Close-up frame

### 2 Move the AF frame so that the subject is in the center of the close-up frame and take the picture.

- Be careful not to change your distance from the subject.



As seen from the viewfinder



- For P (panorama) prints, the difference between the viewfinder image and the actual picture is more pronounced, so you should be 2 m (6.6 ft.) or away from the subject.

## 6 Selecting the Print Type

You can choose from three print types with this camera: C print, H print or P print.

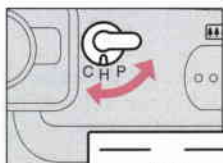

**Use the print type selection lever to select the desired print type.**

- You can change the print type in mid roll.

H print



The viewfinder field changes when the print type selection lever is operated. The black areas in the viewfinder will not be printed.

C print

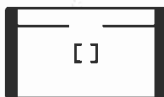

H print



P print

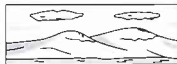

Choose a print type suitable for the subject you are shooting.



- When the shooting distance is between 0.6 and 1 m (2 and 3.3 ft.), the area outside the close-up frame will not be taken.
- For P prints, move more than 2 m (6.6 ft.) away from your subject.



## 7 Zoom Operation

You can use the zoom buttons to change the size of the image.



### Wide-angle (23mm)

Press for a wide area image. For taking landscapes, group pictures, etc.





### Telephoto (69mm)

Press to zoom in on your subject. For taking portraits, etc.

E



### Press the zoom buttons.

- Press  to zoom to the telephoto end, and  to zoom to the wide-angle end.

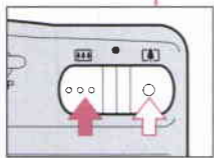

2



- When the power is turned on, the lens first sets to the wide-angle (23mm) position.
- If the lens remains extended for approx. 4 minutes without use, the lens automatically retracts into the camera and is set to the wide-angle (23mm) position. This prevents damage to the lens.

## 8 Shutter Button Action

This camera has a two-step shutter button. When the shutter button is pressed halfway, the exposure and focus are set. When the button is pressed fully, the shutter is released.

The AiAF feature allows you to focus on difficult to focus subjects even if they are not in the center of the viewfinder. (→ 40)

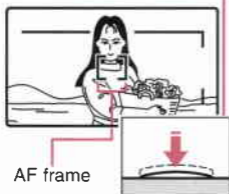
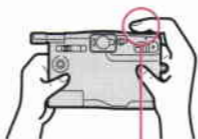

### 1 Place the AF frame over the subject and press the shutter button halfway.

- ➔ The subject is focused.
- Check that the green indicator is lit.
- Keep the shutter button halfway pressed.

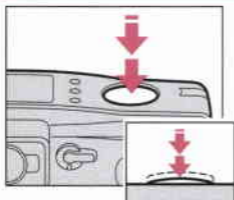

### 2 Press the shutter button fully.

- Press the shutter button gently.
- ➔ The shutter is released.



- There is a very short interval between the shutter button being pressed and the shutter being released. As a general guide, it is best to hold the camera still until you hear the film start to wind forward.

## Green/Orange Indicators

When the shutter button is pressed halfway, the indicators light up or blink to indicate whether or not shooting is possible.

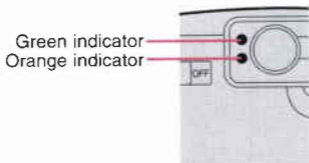

### Green indicator

- Lights up: Ready for shooting (Subject in focus)
- Blinks (4 times/sec.): Close-range warning (See ① below)
- Blinks (2 times/sec.): Real time release mode (→ 38)



### Orange indicator

- Lights up: Flash has charged
- Blinks (4 times/sec.): Camera shake warning in "Flash OFF" mode (See ② below)



- ① Move away from the subject until the green indicator stops blinking. Press the shutter button halfway again.  
For C prints and H prints, the close-range warning distance is between 30 and 60 cm (1.0 and 2.0 ft.). For P prints, the close-range warning distance is between 0.3 and 2 m (1.0 and 6.6 ft.). However, the green indicator may light up when the subject is closer than 30 cm (1.0 ft.). Make sure that the subject is at least 45 cm (1.5 ft.) away.
- ② We recommend you mount the camera on a tripod.

## 9 Removing the Film Cartridge

The film rewinds automatically when it reaches the end. The frame counter counts down during film rewinding. When the film has been fully rewound,  on the LCD panel blinks. Check that  on the LCD panel is blinking before removing the cartridge from the camera.

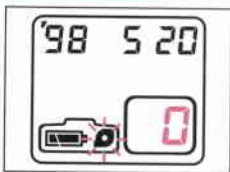

### 1 Check that is blinking.

- Press the  film rewind button if  is not blinking.

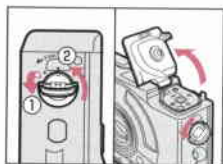

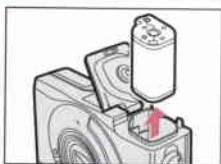

### 2 Open the film cartridge compartment cover.

- Lift the film cartridge compartment cover crank ① and rotate left ② to open the cover.





### 3 Remove the film cartridge.

- ➔  on the LCD panel disappears.
- ➔ The visual exposure indicator on the film cartridge becomes  (exposed).

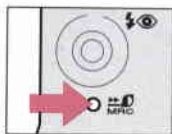
## Rewinding a film cartridge in mid-roll



- Press the  film rewind button.
- The visual exposure indicator on the film cartridge changes to  (partial).
- You can reuse film cartridges that have been rewound in mid-roll. (→ 50)

## Film Cartridge Processing

- Exposed film cartridges can be processed for printing at Advanced Photo System certified shops.
- All certified shops do the following:
  - ① Return your cartridge with the film inside.
  - ② Process all three types of prints.
  - ③ Make an index print sheet.
  - ④ Use the print quality data for better quality prints.
  - ⑤ Imprint the date and title on the back of the print.

## Handling Film Cartridges After Exposure

- When ordering reprints at a certified shop, be sure to match the ID number from the back of the print you want or from the index print with the ID on the film cartridge before handing in your film cartridge.



- Handle and store index prints and returned film cartridges carefully.
- The visual exposure indicator is set to  (exposed) for film cartridges that have been fully exposed, and to  (processed) for film cartridges that have been developed.
- Do not place cameras or film cartridges near televisions, speakers, or other sources of strong magnetic fields.

## Changing the Flash Mode

The flash can be made to fire every time you take a picture, or it can be turned off. Choose a mode suitable for the subject and place you are shooting. Select the flash mode while the camera is turned on.

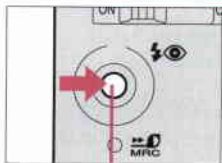

Flash mode button

Press the  flash mode button.

- You can check the mode on the LCD panel.



\* :  Auto flash without red-eye reduction (→ 31)

\* :  Auto flash with red-eye reduction (→ 32)

 Flash ON (→ 34)

 Flash OFF (→ 35)





 Slow-synchro with red-eye reduction (→ 36)

\* : When the flash is set to fire automatically,  appears on the LCD panel when the shutter button is pressed halfway.



- Be careful not to push the flash into the camera. The flash will not fire and the power to the camera will be turned off.



- The camera's default setting is . To change to  after the power is turned on, turn the power off when  is displayed. When the power is turned on again,  will be displayed. To revert to the original state, turn the power off when  is selected.

## 1 Auto Flash Mode without Red-eye Reduction

Set this mode for taking pictures without people, or if you want to shoot right away without the red-eye reduction function.

In low light or backlit conditions, the flash fires automatically when the shutter button is pressed.

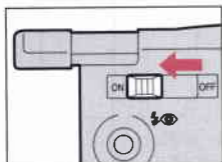



Slide the main switch to the ON position to turn the power on.



### Flash Distance Range (With color print film)

Film speed	Wide-angle	Telephoto
ISO 100	0.6 to 4.4 m (2.0 to 14.4 ft.)	0.6 to 2.0 m (2.0 to 6.6 ft.)
ISO 200	0.6 to 6.2 m (2.0 to 20.3 ft.)	0.6 to 2.8 m (2.0 to 9.2 ft.)
ISO 400	0.6 to 8.8 m (2.0 to 28.9 ft.)	0.6 to 4.0 m (2.0 to 13.1 ft.)







- If  is displayed on the LCD panel, press the  flash mode button until all the flash mode indicators disappear.

## Changing the Flash Mode

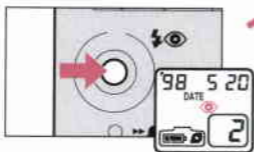
### 2 Auto Flash Mode with Red-eye Reduction •••

Set this mode when shooting pictures of people in low light conditions. When the shutter button is pressed, the red-eye reduction lamp lights up and the flash fires.



**1** Press the   flash mode button and display  on the LCD panel.

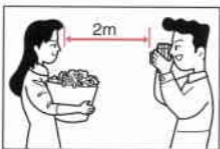

**2** Stay within about 2 m / 6.6 ft of your subject.

- The red-eye reduction lamp is only effective within this distance.

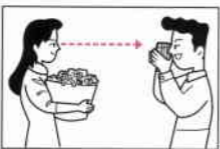

**3** Tell your subject to look at the camera.

- The red-eye reduction function is not effective unless the subject looks straight at the lamp.

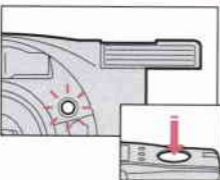

**4** Press the shutter button halfway.

- ➔ The red-eye reduction lamp lights up and the shutter will not release for about one second.
- Keep the shutter button halfway pressed.



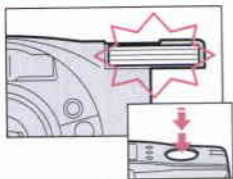

**5** After about one second, press the shutter button fully.

➔ The flash fires and the shutter is released.

## Red-eye Reduction Function

With flash photography in dark places, the subject's eyes may appear red. This phenomenon is called "red-eye" and occurs when flash illumination reflects off the retina.

With the red-eye reduction function , the red-eye reduction lamp lights up to illuminate the subject for about one second before the flash is fired. This will minimize the chances of red-eye.



- When the red-eye reduction lamp lights up, the shutter will not release for about one second. This is to increase the effectiveness of the red-eye reduction function. If you want to shoot right away, turn the red-eye reduction function off with the  flash mode button.



### Important guidelines for using the red-eye reduction function

1. This function is not effective unless the subject looks directly at the red-eye reduction lamp while it is lit. Be sure to tell your subject to look straight at the lamp.
2. Stay within 2 m (6.6 ft.) of your subject.
3. The efficacy of the red-eye reduction function varies from person to person.
4. Set the lens to the wide-angle end.
5. Try to raise the ambient light level as much as possible.

## Changing the Flash Mode

### 3 Flash ON Mode ..... ⚡

The flash fires regardless of the light conditions. Set this mode for fill-in flash during the day, or to soften the outline of the subject.

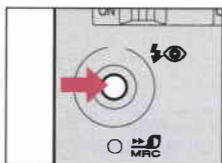

Press the ⚡👁 flash mode button until ⚡ is displayed on the LCD panel.









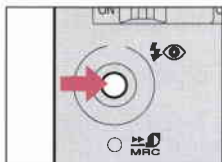

## Changing the Flash Mode

### 5 Slow-synchro Mode with Red-eye Reduction ••

This mode is effective when taking pictures of people with an evening or nocturnal background. Flash and slow shutter speed are effectively combined, so that the flash illuminates the subject, and the slow shutter speed illuminates the distant background.



Press the   flash mode button until ,  and  are displayed on the LCD panel.



- A slower shutter speed (max. approx. 2 sec.) is set in this mode; be sure to use a tripod to avoid camera shake. Also, tell your subject to keep still for a moment after the flash has fired.



- The red-eye reduction function operates in this mode.
- In certain shooting situations, "Auto flash" mode may be more effective for shooting. We therefore recommend you take pictures in both "Slow-synchro" and "Auto flash" modes.

## Focus Lock

Use this mode to focus on a subject positioned close to the edge of the picture frame.

E



**1** Center the AF frame over the subject and press the shutter button halfway.

- ➔ The subject is focused when the green indicator lights up.
- Keep the shutter button halfway pressed.

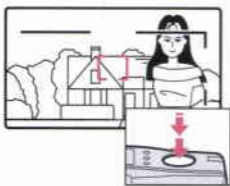

**2** With the shutter button halfway pressed, frame your picture as desired. Then press the shutter button fully.

- ➔ The shutter is released.

3





- Be careful not to change the distance between the subject and the camera. If you do change it, redo focus lock.

## Real Time Release Mode

In normal photography, after you check that the green indicator is lit and press the shutter button, there is a very slight interval (after 0.03 seconds) before the picture is actually taken. With real time release, the picture is taken almost instantly.

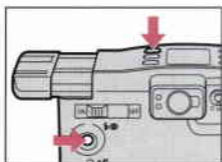
Use this mode for situations such as photographs of rapid movement or children's facial expressions where instant camera response is essential.



- 1 Press the  flash mode button and  remote control/self-timer button at the same time.**

➔ The green indicator blinks (2 times/sec.).



- If you press the shutter button fully right away, real time release will not work.
- Be careful not to change the distance between the subject and the camera once you have focussed on the subject.
- Be careful not to touch the lens. This could result in the picture being out of focus.



## 2 Position the AF frame over the subject and hold the shutter button pressed down halfway.



- ➔ The camera makes a brief zooming sound.
- Make sure that the green indicator blinks (2 times/second).
- Photographs taken with real time release, or with focus lock, can be taken in the same way as in normal photography. (→ 37)









## 3 Keep the camera aimed at the subject. When you see the picture you want, press the shutter button fully.

- ➔ The shutter is released immediately.

### Canceling Real Time Release Mode

- Press the   flash mode button and  remote control/self-timer button at the same time again, or turn the camera off.



- We recommend using , , or  flash modes in real time release mode.   and  flash modes use red-eye reduction and therefore delay the shutter release for approximately one second as they do in normal mode.



- Because auto-focusing is automatically set to one point in the center of the viewfinder, position the AF frame over the subject.

## AiAF (Smart AF) Function

Ai = Artificial intelligence, AF = Auto-focus

The AiAF (Smart AF) function has a wide measuring area and is the latest mechanism for accurate focus adjustment. This mechanism was developed based on the analysis of several thousand photographs and on Canon's unique know-how.



- The camera focuses on the subject even if it is not in the center of the viewfinder, or if there is an obstruction in front of it. The camera will accurately focus on two subjects positioned side by side, and not on the background between them.

## Shooting Through a Window

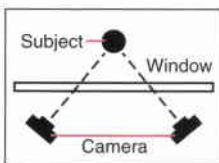

If you are taking a picture through a window, set the camera at an appropriate angle, with a camera-to-window distance of about 20 cm/0.7 ft. If you are too far away from the window, the camera may focus on the glass of the window rather than the subject.



## Self-timer Shooting



Include yourself in the picture by delaying shutter release with the self-timer. Place the camera on a steady surface, or mount it on a tripod.

Select the self-timer and remote control modes while the camera is turned on.

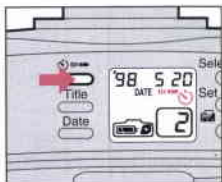
**E**

### 1 Press the remote control/self-timer button.

➔ and are displayed on the LCD panel.

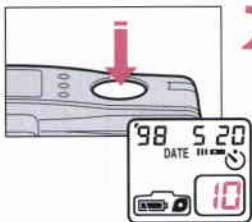

### 2 Compose the picture, then press the shutter button.

➔ The red-eye reduction lamp blinks (once/sec.) for about 10 seconds before the shutter is released.

➔ The LCD panel counts down the remaining seconds.

### Canceling the self-timer

• Press the remote control/self-timer button.



• Do not stand in front of the camera when pressing the shutter button; this will cause incorrect focus.



• The lamp blinks more rapidly approximately two seconds before the shutter is released. However, if the red-eye reduction function has been activated, the lamp will remain lit during the last two seconds before the shutter is released.

• Self-timer shooting is possible for approx. four minutes while is displayed in the LCD panel.

**3**

## Shooting with the Optional Remote Control

Use the remote control to release the shutter from up to 5 m (16.4 ft.) in front of the camera.

### Remote Control (RC-5)

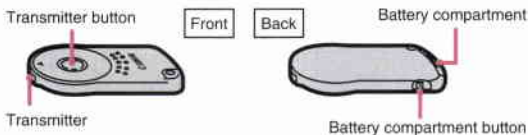

- 1 Press the remote control/self-timer button.  
➔ and are displayed on the LCD panel.

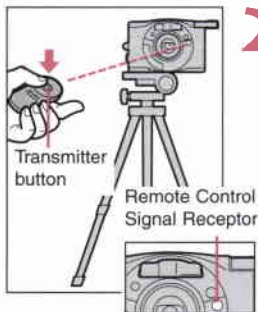

- 2 Compose the picture. Then direct the transmitter towards the camera's remote control signal receptor and press the transmitter button.  
➔ If you are using red-eye reduction mode, the lamp lights. If you are not using red-eye reduction mode, the lamp blinks. In either case, the shutter is released after two seconds.

### Canceling remote control shooting

- Press the remote control/self-timer button and remove and from the LCD panel.

## Replacing the Remote Control Battery

Replace the battery when the shutter no longer releases with the remote control.

Battery: One lithium battery (CR2032, 3V)

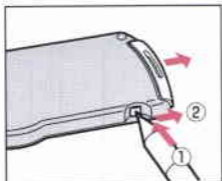
**E**

### 1 While pressing the battery compartment button, pull out the battery compartment.

- While using a ball pen, or similar pointed object, to press the battery compartment button, slide out the battery compartment.

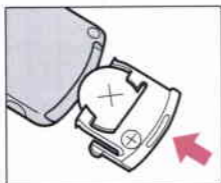

### 2 Load a new battery and replace the battery compartment.

- Remove the expired battery and insert the new one with the + and - terminals positioned correctly.

**3**

- Remote control shooting is possible for approx. four minutes while is displayed on the LCD panel.
- Place the camera on a steady surface or use a tripod.
- Remote control shooting may not be possible if the remote control signal receptor is exposed to strong sunlight or fluorescent light. In this case, use the self-timer to take the picture, or move the camera to a different location.
- The remote control may not operate properly when an inverter-type fluorescent light is nearby. Move the camera away from the inverter-type fluorescent light.

## Date and Time Imprinting

The date and time that a photo is taken can be imprinted on the back or the front and back of the print.



### Press the Date button.

- The mode changes every time you press the button.

### LCD Panel Date Display

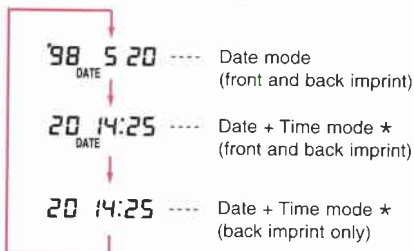

\* : The date and time format for the date display (e.g. 20 14:25) is set by the format selected for the Date mode.



- **Character size, shape, color, position, and ability to print on both sides may vary according to the individual photo shop.**
- Date, time, and title are not photographically imprinted on the film, but are imprinted as part of the developing process, using data (IX information) magnetically recorded on the film.
- In addition to date/time imprinting, the back of the print provides space to imprint the ID of the film cartridge and the frame number.

## Changing the Date Format

E



**In Date mode, press the Set button to select the date format.**

- Use the push-button projection on the strap clasp.
- ➔ The date format changes in the following order:  
year/month/day →  
month/day/year →  
day/month/year.



3

## Setting and Adjusting the Date/Time

After changing the battery, or when traveling internationally, it may be necessary to set or adjust the camera's date and time using the following procedure.

**If "-- -- --" blinks on the LCD panel when you change the battery, perform steps 2, 3, 4, and 6.**

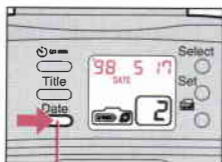

Date button

### 1 Press the Date button to display the Date mode.

- The time is set in Date + Time mode, step 5.

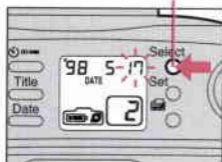

Select button

### 2 Press the Select button.

- Use the push-button projection on the strap clasp.
- ➔ When you replace the battery, the blinking "-- -- --" display changes to "98 1 1".
- The digits to be set start blinking.

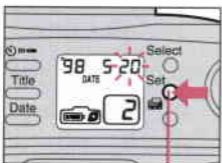

Set button

### 3 Press the Set button.

- Use the push-button projection on the strap clasp.
- Press repeatedly until the blinking digits show the desired value.



**4** Repeat steps 2 and 3 until all digit settings and adjustments are completed, then press the **Select** button to end.

- The date adjustment is complete when the digits stop blinking.



**5** Press the **Date** button to display the **Date + Time** mode.



**6** Repeat steps 2 and 3 until all digit settings and adjustments are completed, then press the **Select** button to end.

- The time adjustment is complete when the ":" in the time display stops blinking.



- If "-- --" blinks on the LCD panel (no Date imprinting) when the battery is replaced, reset the date and time.



- Press the **Set** button to advance the digit by one, or hold for two seconds or more to advance the value continuously.
- The date cannot be set or adjusted in **Date + Time** mode.
- After removing the battery to replace it, do not touch any of the switches on the camera. This allows the date and time settings to be retained for approximately five seconds.

**E**

**3**

## Imprinting Titles

You can imprint titles on the back of the print. Select a title from the different titles available while the camera is turned on.

### Selecting the Title Language

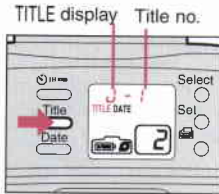

- 1 Press the Title button.**  
➔ The word TITLE is displayed on the LCD panel.

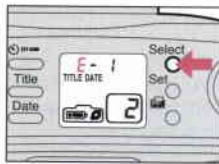

- 2 Press the Select button to select the language.**
  - The language changes every time you press in this order: Japanese, English, French, German, Spanish, Italian.

### Canceling Title Imprinting

- Press the Date button until the word TITLE disappears from the LCD panel.



- The title imprinting function automatically returns to a date/time setting after one frame is exposed. To continuously imprint the same title, hold down the Title button for two seconds or longer (until the word TITLE blinks on the LCD panel).
- **Character size, shape, color, position, and ability to print on both sides may vary according to the individual photo shop.**
- The date and time as set by the Date function are also printed with the title.
- If you want information imprinted on the front of your prints, be sure to check with the photo shop, that they provide this service, before the film is processed.



## Selecting the Title

Once you have selected the language for your title, you can select the title.

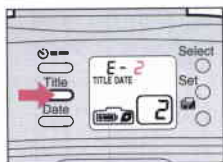
**E**

### Press the Title button.

- ➔ The title number changes every time you press.
- Select the title you want to use, then take the picture.

## Title Button Sequence

E-1 I LOVE YOU

E-2 THANK YOU

E-3 SEASON'S GREETING

E-5 HAPPY BIRTHDAY

E-4 CONGRATULATIONS

### Japanese Titles

- J-1 オメデトウ
- J-2 カンゲキ!
- J-3 カワイイデショ!
- J-4 ヨロシク!
- J-5 ウレシイナ

### French Titles

- F-1 JE T'AIME
- F-2 MERCI
- F-3 MEILLEURS VOEUX
- F-4 JOYEUX ANNIVERSAIRE
- F-5 FÉLICITATIONS

### Italian Titles

- I-1 TI AMO
- I-2 GRAZIE
- I-3 BUONE FESTE
- I-4 BUON COMPLEANNO
- I-5 CONGRATULAZIONI

### German Titles

- D-1 ICH LIEBE DICH
- D-2 DANKE SCHÖN
- D-3 HERZLICHE GLÜCKWÜNSCHE
- D-4 FRÖHLICHE WEIHNACHTEN
- D-5 FROHES NEUES JAHR

### Spanish Titles

- ES-1 TE QUIERO
- ES-2 GRACIAS
- ES-3 FELICES PASCUAS
- ES-4 FELIZ CUMPLEAÑOS
- ES-5 FELICIDADES

**3**



## Mid-roll Film Change

This camera supports one of the most useful features of the Advanced Photo System, mid-roll film changing. This feature automatically advances the film to the first unexposed frame if a partially exposed film cartridge is loaded in the camera. You can then continue taking pictures until the cartridge is completely exposed. This allows you to use separate film cartridges for different types of subjects, or moods.

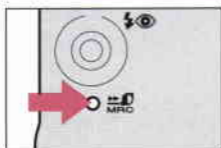
### Rewinding a film cartridge in mid-roll



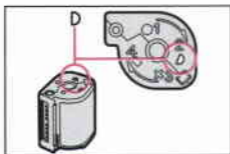

Press the  film rewind button.

- The film starts to rewind.
- Check that the film has fully rewound (  on the LCD panel blinks) and remove the cartridge.
- The visual exposure indicator on the cartridge changes to  (partial).



MRC : MID ROLL CHANGE



- If  on the LCD panel and the frame counter blink during film rewind, it means that there was an error during film rewind. If this happens, remove and reload the camera battery, then press the  film rewind button again. If the camera still does not operate, turn off the camera and take the camera to your nearest Canon service facility.

## Reloading a Partially Exposed Film Cartridge

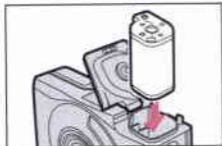

Load the film in the same way as described in "Loading the Film Cartridge". (→ 16)

➔ The camera automatically advances the film to the first unexposed frame.



### Film Winding Speed to Unexposed Frame

Film Status	Required Time
Frame 1 exposed, winding to frame 2	Approx. 16 seconds
Frame 39 exposed, winding to frame 40	Approx. 35 seconds



- If there is a TV or other device emitting strong radio waves, or a strong magnetic field, the camera may not be able to reload partially exposed film. If this happens, "0" in the frame counter and  on the LCD panel blinks as a warning. In such a case, remove the partially exposed film cartridge. Load a new, unexposed film cartridge instead. The new film cartridge will load normally.
- Be careful not to load a partially exposed film cartridge in a camera that does not support mid-roll film change (such as the Canon ELPH/IXUS). The camera will set the visual exposure indicator to "Exposed" and will not load the film. This means you will not be able to use the remaining unexposed part of the film.

## Setting the Print Quantity

This camera allows you to set the print quantities for a print to between 0 and 9. This means you can increase the number of prints without having to wait for the film to be processed, and also allows to avoid printing pictures that were taken by accident. Please note that the print quantity setting or changes to the setting only apply to the next frame to be shot or to the previous shot.

- The print quantity display is automatically set to 1 print (P-1) when negative film is loaded.
- When slide film is loaded, the print quantity display is automatically set to no print (P-0).

### Setting the Print Quantity for the Next Shot

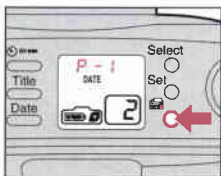

#### 1 Press the print quantity button.

- Use the push-button projection on the strap to push the button.
- ➔ "P-1" (1 print) appears in the LCD panel.

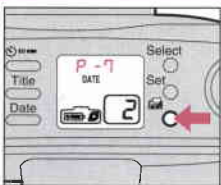

#### 2 Press the button until the number of prints you want to set for the next shot appears in the LCD panel.

- ➔ The print quantity display changes as follows: P-1, P-2... P-9, P-0, P-1.

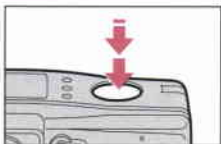



#### 3 Take the picture.

- ➔ After the shot has been taken, the print quantity setting is canceled and the normal single print setting is resumed.

## Changing the Print Quantity After Taking a Shot

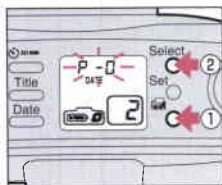
E



**1** Press the  button ① and press the **Select** button for two seconds, or longer ②.

- Use the push-button projection on the strap to push the button.
- ➔ "P-0" (no print) blinks in the LCD panel.

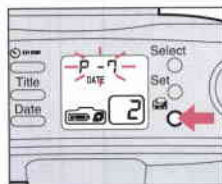

**2** Press the  button until the number of prints you want to set for the shot appears in the LCD panel.

- ➔ The print quantity display changes as follows: P-1, P-2... P-9, P-0, P-1.



**3** Press the **Set** button.

- ➔ The film is rewound one frame and the print quantity setting is adjusted.
- The setting is complete and the display changes to the date and time.



3



- If the camera is turned off before either of the film quantity setting procedures is completed, the setting will revert to the previous setting.
- You cannot use the print quantity setting when "-- -- --" is displayed on the LCD panel. Make sure that the date and time have been set before setting the print quantity.
- Press the  button once to advance the print quantity by one, keep the button pressed to advance the value continuously.
- Not all print shops can process the print quantity setting when the film is developed and printed.

## Troubleshooting

In case of trouble check the table below before taking you camera to be repaired.

Problem	Cause	Remedy	Page
The battery check indicator  blinks.	<ul style="list-style-type: none"> <li>•The battery has expired.</li> </ul>	<ul style="list-style-type: none"> <li>•Replace the battery.</li> </ul>	15
The battery check indicator  is not displayed.	<ul style="list-style-type: none"> <li>•No battery is loaded.</li> </ul>	<ul style="list-style-type: none"> <li>•Load a battery.</li> </ul>	15
	<ul style="list-style-type: none"> <li>•The battery is inserted with the wrong polarities.</li> <li>•The battery has completely expired.</li> </ul>	<ul style="list-style-type: none"> <li>•Reinsert the battery correctly.</li> <li>•Replace the battery.</li> </ul>	15
The shutter does not release.	<ul style="list-style-type: none"> <li>•The power is turned off.</li> </ul>	<ul style="list-style-type: none"> <li>•Turn the power on.</li> </ul>	19
	<ul style="list-style-type: none"> <li>•The battery has expired.</li> </ul>	<ul style="list-style-type: none"> <li>•Replace the battery.</li> </ul>	15
	<ul style="list-style-type: none"> <li>•A fully exposed film cartridge has been loaded in the camera.</li> </ul>	<ul style="list-style-type: none"> <li>•Remove the film cartridge and load a new one.</li> </ul>	16, 28
	<ul style="list-style-type: none"> <li>•The shutter will be released only after the red-eye reduction lamp is lit for about 1 second.</li> </ul>	<ul style="list-style-type: none"> <li>•Keep pressed until the shutter is released.</li> <li>•Change the flash mode.</li> </ul>	33 30
The photographs are blurred.	<ul style="list-style-type: none"> <li>•When the shutter was released, the AF light emitter/receptor were blocked.</li> </ul>	<ul style="list-style-type: none"> <li>•Ensure that the AF light emitter/receptor are not blocked by hair, fingers, etc.</li> </ul>	21
	<ul style="list-style-type: none"> <li>•In self-timer shooting, you stood immediately in front of the camera when pressing the shutter button.</li> </ul>	<ul style="list-style-type: none"> <li>•Make sure you do not stand immediately in front of the camera when pressing the shutter button.</li> </ul>	41
	<ul style="list-style-type: none"> <li>•The camera moved when the shutter button was pressed (camera shake).</li> </ul>	<ul style="list-style-type: none"> <li>•Press the shutter button gently.</li> </ul>	26
	<ul style="list-style-type: none"> <li>•The AF light emitter/receptor may be dirty.</li> </ul>	<ul style="list-style-type: none"> <li>•Wipe them clean.</li> </ul>	21

Problem	Cause	Remedy	Page
"H" is displayed on the LCD panel.	•The self-diagnosis function detected an error.	•Remove the battery from the camera. When "H" disappears from the LCD display, load the battery again.	15
The flash does not fire.	•The flash unit is pushed in.	•Do not press on the flash unit.	21
The film cartridge compartment cover will not open, even when the film counter reads 0.	•A problem occurred after rewinding.	•Press the  film rewind button.	28

## Questions and Answers

**Q1 Can previous 135 (35mm) film be used?**

A1 No it cannot be used. Use IX240 film cartridge.

**Q2 Can slide film be used with this camera?**

A2 Yes it can.

**Q3 What is ISO?**

A3 The ISO number indicates the film's sensitivity to light in numerical terms. The higher the number, the more sensitive the film is to light.

**Q4 The picture was taken with date imprinting, but it doesn't appear on the index print. Why is this?**

A4 The date and time are recorded on the film surface magnetically. This data is read electronically and printed during the printing process. This is why the date and time data may not appear on the index print sheets.

**Q5 When converted to a 35mm camera, what is this camera's 23–69mm focusing distance equivalent to?**

A5 Approximately 29mm–87mm (for H prints).

## Specifications

**Type:** IX240 lens/shutter type, AF, fully automatic camera with built-in zoom lens and magnetic IX functions

**Image Size:** 16.7 × 30.2 mm

**Lens:** Canon 23-69mm f/4.5-9.9

**Focus Control:** Active/passive/hybrid auto-focus system

**Shooting Distance:** 0.6 m/2.0 ft. to infinity

**Shutter:** Combination aperture and program electromagnetic drive shutter

**Viewfinder:** Real-image zoom viewfinder

**Picture coverage:** Approx 90%

**Viewfinder Displays:** Picture frame, AF frame, close-up frame

**Viewfinder Eyepiece Area:** Green indicator (ready for shooting/close-range warning), Orange indicator (camera shake warning/Flash charged)

**Film Loading:** Automatic (automatic blank film advance)

**Film Winding:** Automatic

**Film Rewinding:** Automatic at end of film, mid-roll rewinding possible

**Frame Counter:** Counts up during winding, counts down during rewinding

**Self-timer:** Electronically-controlled 10-second delay timer, activated by pressing the shutter button. The red-eye reduction lamp blinks during operation and the frame counter counts down the remaining seconds.

**Remote control function (with optional RC-5):**

Remote control system using infrared light; activated with the transmitter button, 2-second delay release

Operating distance range: Within approx. 5 m (16.5 ft.).

Battery life: approx. 6000 times

**Metering Range (ISO 100):**

AUTO/Flash ON modes:

Wide-angle: 1/100 f/4.5 to 1/500 f/16 (approx. EV11 to EV17)

Telephoto: 1/100 f/9.9 to 1/350 f/19 (approx. EV13.3 to EV17)

Flash OFF/Slow-synchro modes:

Wide-angle: 2 sec. f/4.5 to 1/500 f/16 (approx. EV3.4 to EV17)

Telephoto: 2 sec. f/9.9 to 1/350 f/19 (approx. EV5.7 to EV17)

**Exposure Compensation:** +1.5 step automatic exposure compensation in backlit conditions if necessary

**Film Speed Setting:** ISO 25 to 10000; Automatically set in 1/3-step increments



**Built-in Flash:** Internal flash with automatic operation in low light and backlit conditions

**Flash Range:** With ISO 100 color print film:

Wide-angle: 0.6 to 4.4 m (2.0 to 14.4 ft.)

Telephoto: 0.6 to 2.0 m (2.0 to 6.6 ft.)

**Flash Recycling Time:** Approx. 7 seconds

**Flash Conditions:** With flash mode button

- ① Full-auto mode: Automatically fires in low light and backlit conditions
- ② Auto mode with red-eye reduction: Automatically fires in low light and backlit conditions
- ③ Flash ON mode: Fires every time
- ④ Flash OFF mode: Does not fire
- ⑤ Slow-synchro mode: Fires every time (with red-eye reduction)

**Date/Title Function:**

Type: Built-in LCD panel and automatic calendar with quartz digital date/time clock, programmed with dates until the year 2029 (compensates automatically for long and short months and leap years)

Data types: Date/Date + Time, Titles (6 languages, 5 formats)

Character type: Depends on the lab's capabilities

Data color: Depends on the lab's capabilities

**Power Supply:** One lithium battery (CR2, 3V)

**Shooting Capacity:** Approx. 8 film cartridges of 25-exp. (with 50% flash use)

**Dimensions (W × H × D):** 95 × 64.5 × 32 mm  
(3.7 × 2.5 × 1.3 in)

**Weight:** 205 g (7.2 oz.) (without battery)

- All data are based on Canon's Standard Test Method.
- Subject to change without notice

## Free Manuals Download Website

<http://myh66.com>

<http://usermanuals.us>

<http://www.somanuals.com>

<http://www.4manuals.cc>

<http://www.manual-lib.com>

<http://www.404manual.com>

<http://www.luxmanual.com>

<http://aubethermostatmanual.com>

Golf course search by state

<http://golfingnear.com>

Email search by domain

<http://emailbydomain.com>

Auto manuals search

<http://auto.somanuals.com>

TV manuals search

<http://tv.somanuals.com>