

CB/6-41

Canon 7s

INSTRUCTIONS

English Edition



CANON 7S SPECIFICATIONS

Exposure Meter :

Match needle type CdS meter coupled to the shutter dial. With ASA 100 film, the high and low two-stage conversion system ranges between EV 2-11 and EV 10-19. Use ASA 6-400, and utilizes 1.3 V MD (#625) type mercury battery. Battery checker built-in.

Shutter :

All metal focal-plane type. Single-pivot rigid shutter speed dial, equally calibrated from 1/1000 to 1 sec., B and T.

Finder :

Universal viewfinder for 35, 50, 85, 100, and 135mm Canon lenses. Automatically corrected for parallax during focusing.

Lens Mount :

New dual mount takes all thread-mount Canon lenses as well as the bayonet mount 50mm F 0.95 and the lenses with Mirror Box 2.

Lens :

Accepts Canon's unique bayonet-mount Canon lens 50mm F 0.95 as well as all thread-mount

Canon lenses.

Flash Synchronization :

Synchronizing possible for FP and X contacts and FP class, M class, F class, and speedlight. Automatic time-lag adjustment. JIS B-(Continental-) type socket.

Self-timer :

Time-adjusting type operated by shutter button.

Winding Lever :

Single-stroke 125° winding lever with short-stroke ratchet.

Film Rewinding :

Rapid crank system.

Film Loading :

Back cover opening and closing, using magazine or cartridge.

Exposure Counter :

Self-resetting type.

Body Size :

140×31×81mm (5-1/2×1-3/4×3-1/8 in.).

Body Weight :

630 grams (1 lb. 4 oz.).

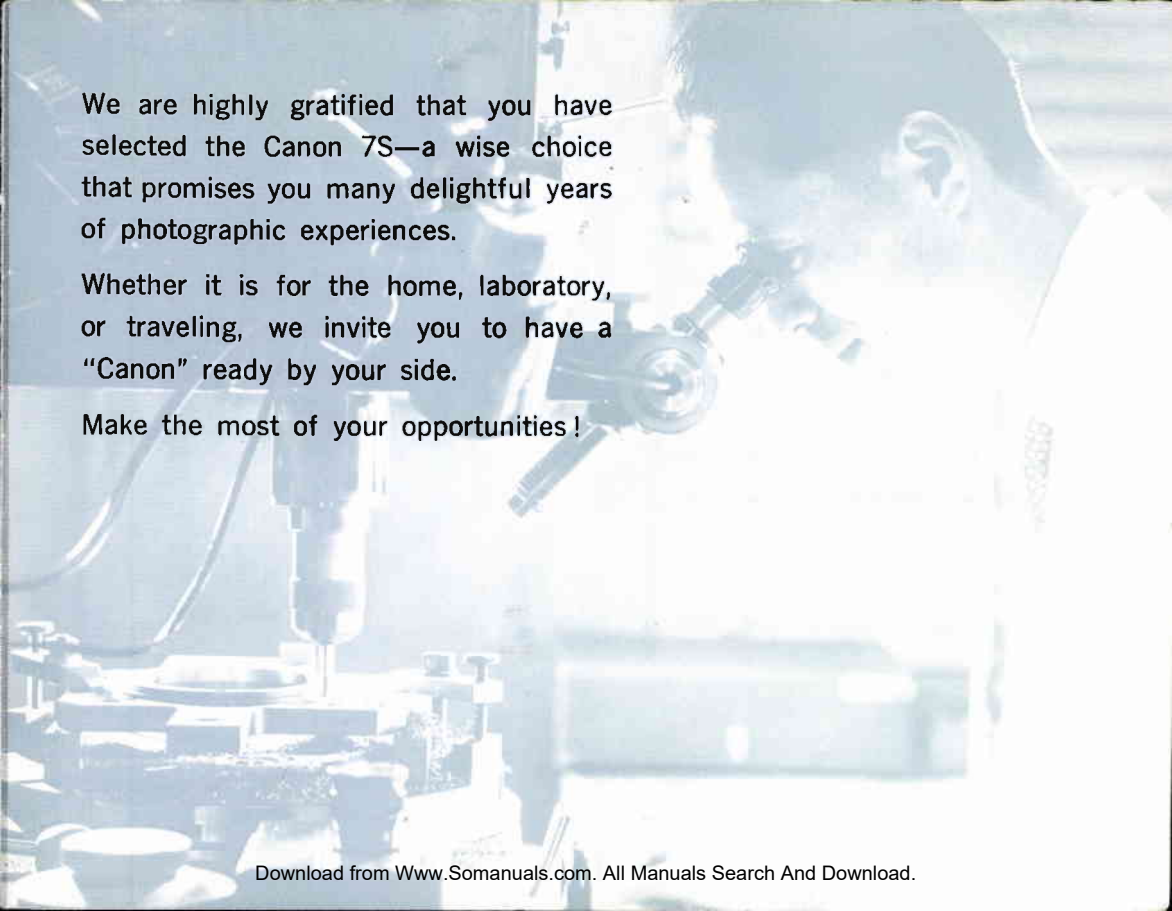

We are highly gratified that you have selected the Canon 7S—a wise choice that promises you many delightful years of photographic experiences.

Whether it is for the home, laboratory, or traveling, we invite you to have a “Canon” ready by your side.

Make the most of your opportunities!

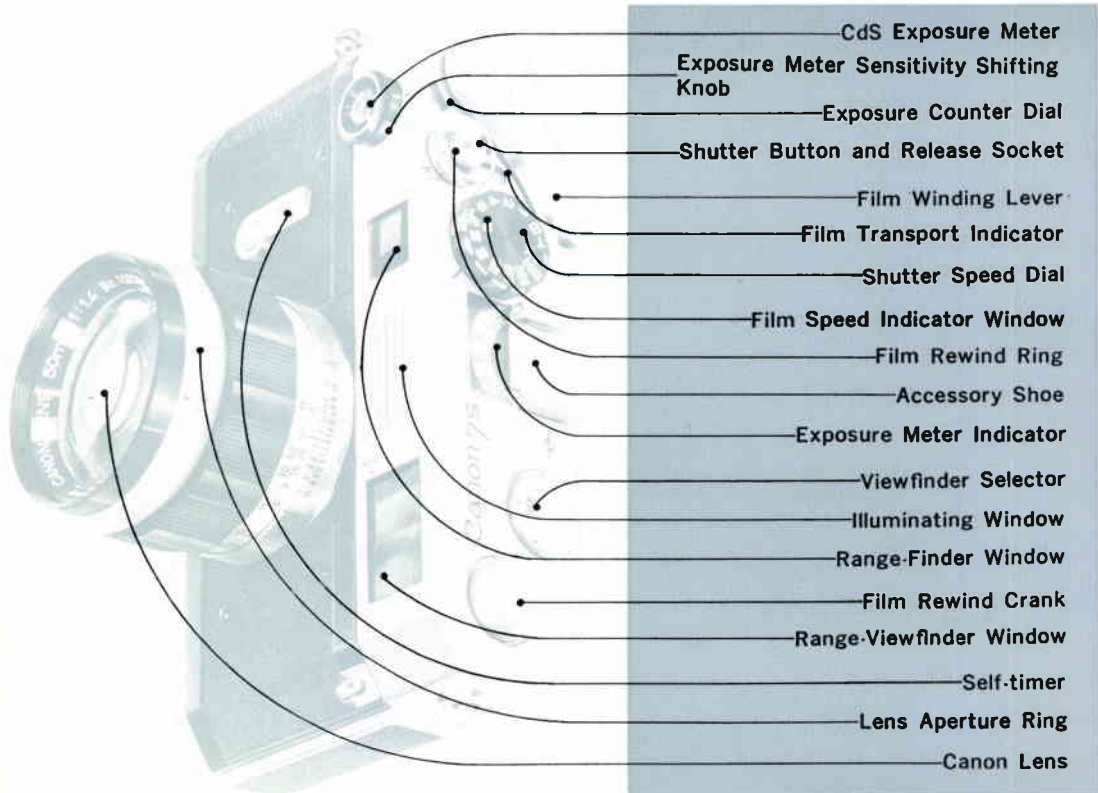

CdS Exposure Meter

Exposure Meter Sensitivity Shifting Knob

Exposure Counter Dial

Shutter Button and Release Socket

Film Winding Lever

Film Transport Indicator

Shutter Speed Dial

Film Speed Indicator Window

Film Rewind Ring

Accessory Shoe

Exposure Meter Indicator

Viewfinder Selector

Illuminating Window

Range-Finder Window

Film Rewind Crank

Range-Viewfinder Window

Self-timer

Lens Aperture Ring

Canon Lens

Flash Unit Connector Socket

Lock for Back Cover

Magazine Opening Key

Tripod Socket

Range-Viewfinder Eyepiece

Exposure Meter ON-OFF-CHECK Switch

Back Cover

Film Speed Indicator Button

Mercury Battery Compartment



PROPER CARE OF YOUR CAMERA

Storage of Camera

Moisture and dust are harmful to your camera. It should be taken out into the fresh air from time to time.

If your camera is to be stored for a long time, it should be removed from its case. Silica gel or another drying agent should be placed alongside it.



Cleaning of the Camera

When you use your camera on a rainy day, or at the beach, moisture and salt air adhere to it, which can result in stains, rust, and corrosion. Use a soft brush to rid the body of dust and a dry, soft cloth for wiping.

Cleaning of the Lens

Use a blower with a rubber ball to blow away dust on the lens or brush lightly with a brush. Do not touch the lens. If you should inadvertently get a finger print on your lens, follow this procedure: use a little pure alcohol or ether, if available, on special lens tissue. Then wrap the tissue around a wooden matchstick and wipe the lens in a circular motion... lightly and systematically.

- In extremely cold areas, expose the camera to the outer air only when in use. Put it back immediately after use. When using, expose the camera gradually to the outer air to prevent the lens from clouding.

Contents

Mercury Battery Loading	6
Film Winding	8
Shutter and Aperture Adjustment	10
Built-in Exposure Meter	12
Holding the Camera	17
Focusing	18
Film Loading.....	20
Film Rewinding	27
Self-timer	29
Flash Synchronization	30
Special Care of Lenses.....	31
How to Load Film into the Magazine	37
Double Exposures	39
Filters	40
Interchangeable Lenses and Accessories	42
Preliminary Steps in Photography	44
Proper Care of Your Camera	47



MERCURY BATTERY LOADING

Load the mercury battery into the battery compartment. Since the mercury battery powers the built-in CdS meter, the meter will not function unless the battery is in position.

1. To remove the battery cover, turn to the left by using a coin.
2. Face the central contact of the mercury battery inwards and insert, then screw the cover back in.

When inserting, do not confuse the \oplus \ominus . Not only will the meter fail to function in case of re-

verse insertion, but the cover cannot be screwed in properly.

- For mercury battery, the National M-1D or the Toshiba TH-MC is used—equivalent to the United States Mallory RM-625R, Eveready E 625, GE #625. Life of the battery in continuous use is over one year.
- Before insertion, clean mercury battery thoroughly with a dry cloth. Perspiration or finger marks may cause corrosion and may prove particularly harmful to center of contact. Unclean battery may also damage the contact point of camera.
- When not in use for a long period, remove the mercury battery and keep in a dry place.



Battery Check

Check the mercury battery after loading it. Especially when loading a new battery, be sure to check the voltage.

1. Turn the revolving switch to match the "C" indicator.
2. Check the efficiency of the battery by reading the meter needle. Voltage is sufficient if the needle swings to the right side within the blue colored section. If the needle stops on the left side, the battery must be replaced.



Need to replace (white) Sufficient power (blue)



FILM WINDING

1. Turn the film winding lever until it stops. The film will be advanced to the next exposure and the shutter cocked. At the same time, the exposure counter dial is advanced to the next number.
2. When the shutter button is pressed, the film can be wound again with the lever after the shutter is actuated.
 - Before winding the lever, be sure to return the film rewind ring index to the "A"

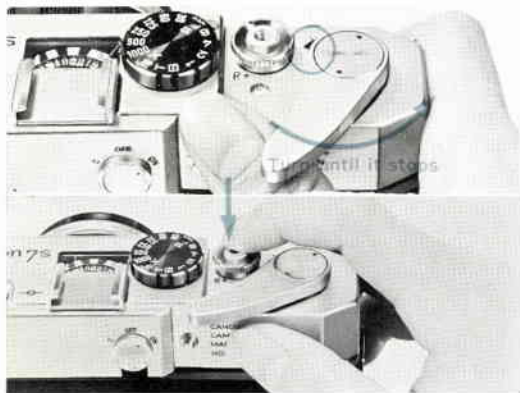

position.

- The winding may be done by moving the lever with several short strokes.
- After loading the film, make another wind, since there is the possibility of the very first winding not catching.
- Unless the winding is completed, the shutter will not be actuated, even though the shutter button is pressed. Check the winding once more.
- When the camera is not in use, return the lever to its original position against the body.

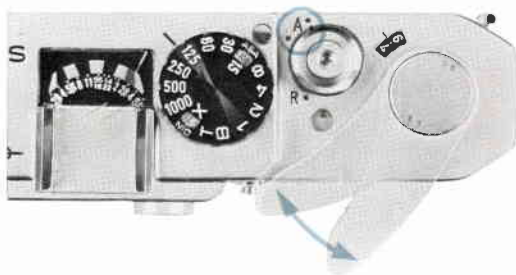

Shutter Button Safety Lock

If you put the index of the rewind ring on the red dot after the shutter is cocked, the shutter button is locked. This is an added safety device when carrying the camera with shutter cocked. This also enables you to attach the cable release after the shutter is cocked without fear of actuating it.

Exposure Counter Dial

The film is advanced whenever the film winding lever is completely wound and the exposure counter dial is advanced by one number indicating the number of exposed films. The exposure counter dial returns to starting position "S" automatically when the back cover is opened.

Attaching the Cable Release

A cable release can be attached to the shutter button.

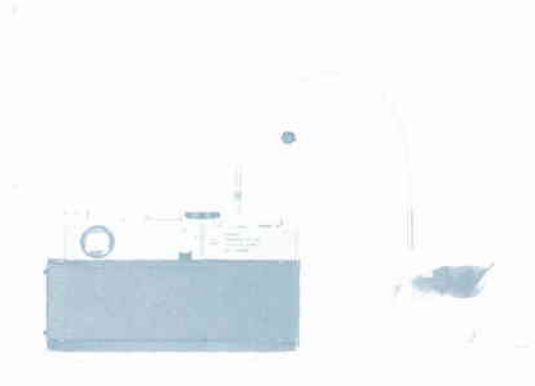
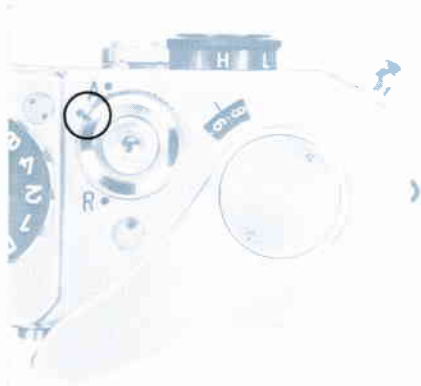

SHUTTER AND APERTURE ADJUSTMENT

Exposure adjustment is done by adjusting the shutter speed and the lens aperture. Correct exposure is easily determined by the coupled, built-in exposure meter.

How to Set the Shutter Speed

Turn the shutter speed dial and set the desired shutter speed figure to the index mark.

The shutter can be adjusted to speed of 1 second, 1/2, 1/4, 1/8, 1/15, 1/30, 1/60, 1/125,

Make reverse turn when it stops at X.

Make reverse turn when it stops at 1000.

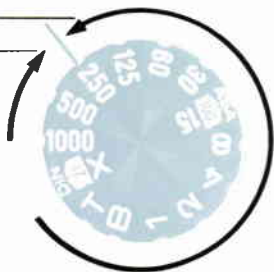

The dial cannot be turned between 1000 and X.

1/250, 1/500, and 1/1000 of a seconds as well as "B" (bulb) and "T" (time) exposures and "X".

The "B" exposure is used for exposures of over 1 second. The shutter stays open as long as the shutter button is kept depressed.

The "T" exposure is used for long exposure. When the shutter button is pressed, it will remain depressed, even after your finger is removed, leaving the shutter open. By turning the shutter speed dial slightly in either "B" or "X" direction, the shutter button snaps back into its former position and the shutter closes.

The "X" scale reading is used for speedlight synchronization. The shutter speed is 1/60 of a second. However, the effective time of the exposure in this case depends on the peak performance of the speedlight used.

- Do not set the shutter speed dial between two figures. It must be set exactly on a "click" stop.

How to Set the Lens Aperture

The lens aperture adjusts the light volume that reaches the film and also the depth-of-field. (See page 35.)

The desired aperture stop can be obtained by turning the lens aperture ring until the figures align with the index mark.

Canon 7S, by using the built-in meter, can easily determine the lens aperture which sets the shutter speed.

- In the case of the aperture, as the numerical value gets larger the amount of light reaching the film becomes correspondingly less. For

each aperture, the light is reduced one-half. Accordingly, when the aperture is increased by one index point, the exposure is doubled, and when it is increased by two index points the exposure is quadrupled.

- The lens aperture ring can also be set to intermediate values.
- The ratio between aperture and the amount of exposure, using F2 as the basis, is as follows:

Lens Aperture

0.95 1.2 1.4 1.8 2 2.8 (3.5) 4 5.6 8 11 16 22

Exposure Ratio

1/4 1/3 1/2 1/1.2 1 2 (3) 4 8 16 32 64 128



2. Turn the switch to ON.
3. Determine the meter sensitivity.

In ordinary brightness outdoors, turn the sensitivity shifting knob to match "L" for low sensitivity use. Make adjustments to "H" for indoors or outdoors just before sunset.

- The sensitivity of the meter is based on a two-stage high and low system. For low sensitivity (bright subject), the setting should be EV 10-19 (F 1.4 1/500 sec.-F 22 1/1000 sec.). For high sensitivity (dark subject), the setting should be EV 2-11 (F 1 1/4 sec.-F 2 1/500 sec.).

4. For "L" (low sensitivity), use the white figure of the aperture reading. When using "H" (high sensitivity), follow the orange figures.

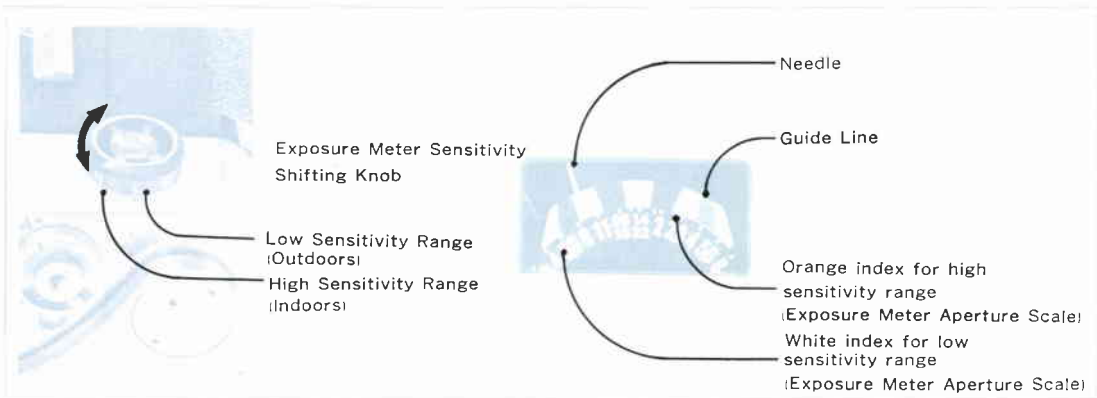

Exposure Setting 1

1. Set the lens aperture.
2. Facing the camera towards the subject, the position of the meter needle is determined.
3. Turn the shutter dial and adjust the same figure as the lens aperture to the guide line where the needle stops.
4. Set the shutter dial to the click stop position. The exact exposure has now been set.
 - When measuring the brightness, be careful not to cover the exposure meter window with your hand. Since the exposure meter

acceptance angle is 40° , it is possible to measure the main subject without being hindered by excessive light (light other than that reflected from the subject).

- The exposure meter cannot be used for "B" and "T" or when using speedlight.
- Reading of the aperture stop is made according to the guide line.
- During the use of the meter, there are instances of the movement of the needle becoming slack, owing to changes in the degree of light, but this is due to the characteristics of the CdS.

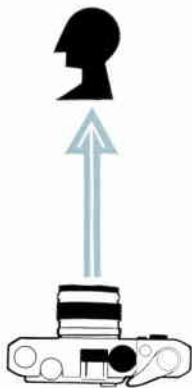

Exposure Setting 2

1. Set the desired shutter speed.
 2. Turn the camera towards the subject to be photographed.
 3. Read the aperture stop to which the needle is pointing, and set the lens aperture.
- Intermediate positions on the shutter dial scale cannot be used, but since any aperture may be utilized, the shutter speed should first be determined when strictly considering the exposure. It is most practical to adjust the aperture according to this.



- When the camera is not to be used for a long time, always turn the switch to "OFF". Also, make a battery check before using again.

When taking portraits against bright backgrounds as the sky, cloud or sea, there is the possibility of the subject being under-exposed. This is due to the fact that the meter has been over-sensitized to the brightness of the background, thus failing to produce the correct reading for the subject. In such a case, make the measurement near the subject. Be especially careful when the picture is being taken against the light.

When taking pictures against the light, it is important to place the emphasis on the background, or the subject. Determine the exposure while paying due consideration beforehand to the results desired. Be careful also of the tendency to tilt the camera upwards when reading the meter needle.

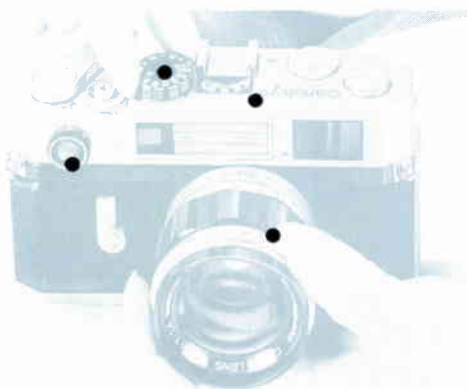
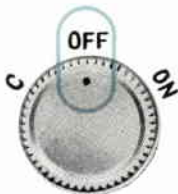

HOLDING THE CAMERA

It is important to hold the camera properly in order to obtain clear and sharp pictures. Hold the camera in a vertical or horizontal position. . . look through the viewfinder and focus. Then press the shutter button gently.

The following steps are important:

1. Hold the camera snugly in both hands. The camera should be pressed firmly to your cheek

or forehead.

2. When using in a horizontal position, both elbows should be pressed against your body. In a vertical position, at least one elbow should be pressed against your body.
3. Hold your breath and press the shutter button with a smooth, steady stroke. If not done in this manner, you will have a blurred picture.
 - For exposures longer than 1/30 sec., you should use a tripod and cable release to prevent movement.



FOCUSING

The lens has a "stopper" at the infinity position. Release the lens by pressing the stopper and rotating the lens barrel. The lens will move back and forth by rotating the lens barrel, which is coupled to the rangefinder, enabling you to focus. Canon telephoto lenses do not have a stopper.

Range-Viewfinder

When you look through the range-viewfinder eyepiece and rotate the lens barrel, you will see two images either coincide or remain apart within the comparatively bright square in the center. When they coincide, your lens is in focus.

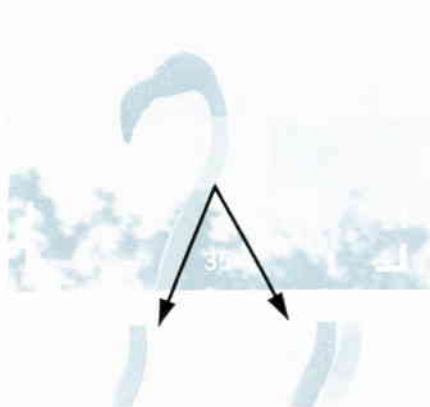
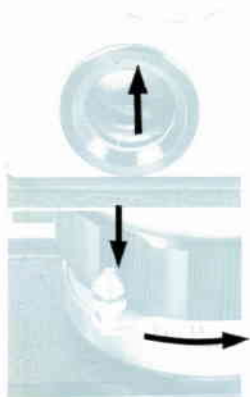

Range-Viewfinder Selector

When you look through the range-viewfinder, you will see a white frame and a figure. The figure indicates the focal length of the lens, and the view seen within the white frame in the viewfinder is that which will be recorded on the film. The field of view indicated by a white frame varies according to the focal length of the lens used when the range-viewfinder selector is shifted. The range-viewfinder can be used for the focal lengths of 35mm, 50mm, 85mm, 100mm, 135mm lenses. You will see a double

white frame for 85mm and 100mm focal lengths. Within the outer white frame is the field of view for an 85mm lens. In the inner white frame area is the field of view for a 100mm lens.

- The white frames are coupled to the focusing mechanism. Parallax is compensated automatically.
- The range-viewfinder is equipped with a standard diopter eyepiece. Interchangeable eyepieces are available for those who are near- or far-sighted.

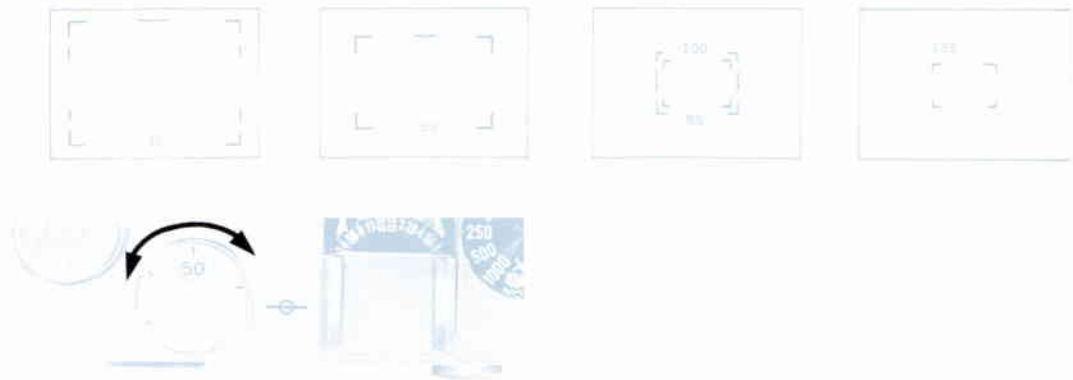

FILM LOADING

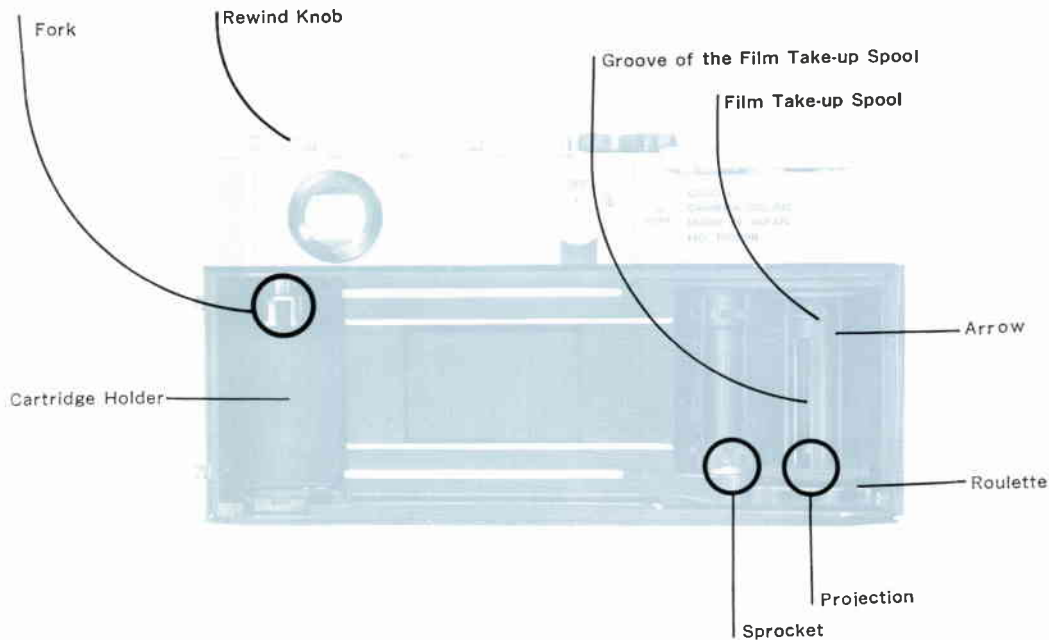

Canon 7S accepts any standard 35mm film cartridge as well as the Canon Film Magazine which is available as an accessory.

When loading a new film, avoid direct sunlight. When unavoidable, face back to the sun and load quickly.

1. To open the back cover, turn the magazine opening key counter-clockwise. Pull down the hinged-back lock while holding the back cover with your fingers. The back cover will then swing open.

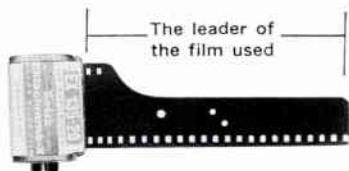

2. Lift up the rewind crank. Put the film cartridge into the recess directly beneath the rewind crank. Press the film rewind crank again to lock the film cartridge into place.
3. Rotate the take-up-spool until you can slide the end of the leader into the groove. Then engage the second perforated hole of the leader with the small hook inside the groove. Adjust the film so that the perforations fit the sprocket.

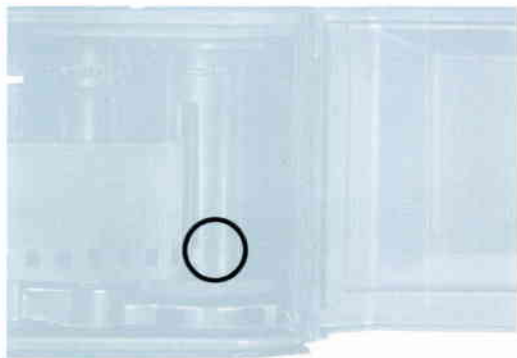
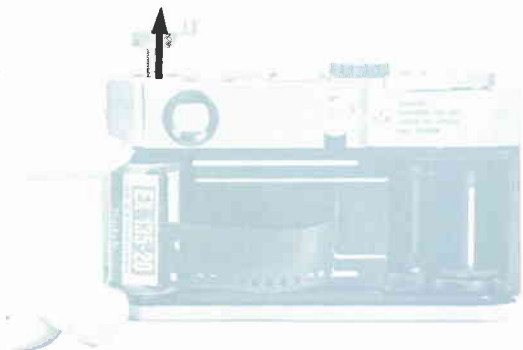

4. With your thumb on the knurled lower end of the take-up-spool, turn the spool clockwise until the film is taut.
5. Turn the advance lever, and wrap the film around the spool once.

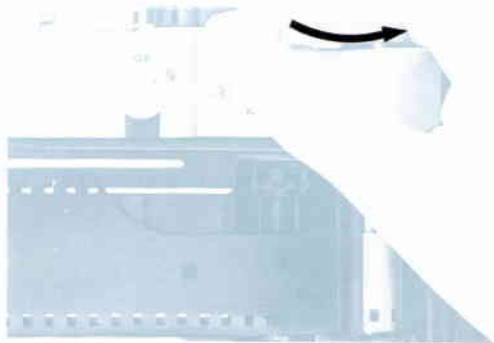
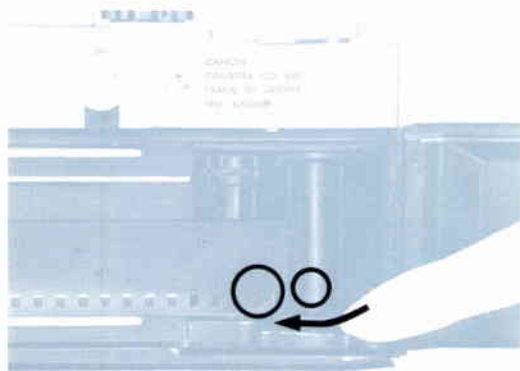

6. If the film sags, pull up the rewinding crank and remove the sagging by gently turning to the right.

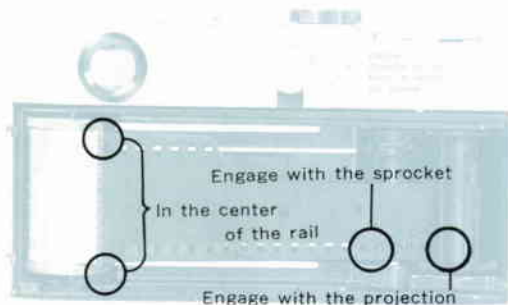

7. Close the back cover, which locks automatically.

Then turn the magazine opening key clockwise to "close", and return the knob to its former position.

- Do not turn the magazine opening key before closing the back cover.



8. Leave the lens cap on and advance the film twice, each time releasing the shutter. The exposure counter dial will advance from "S" to "O".

Wind the lever again and you are ready for the first shot.

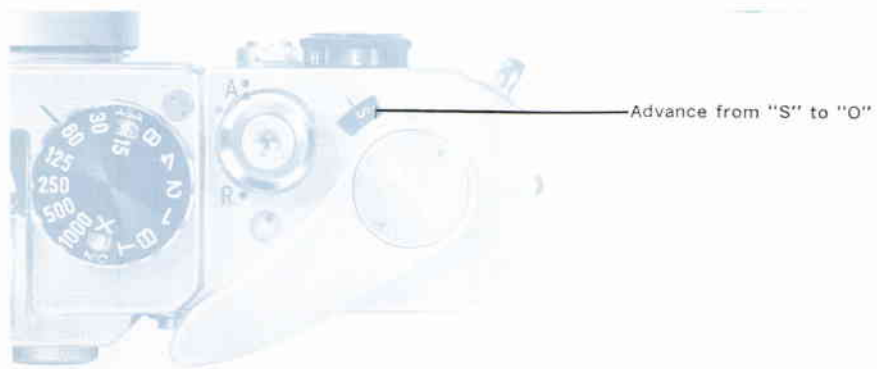

- After you have finished loading the film, be sure to set the film speed used on the film speed indicator window. Refer to page 13 for setting the film speed.
- The film is properly loaded and transported if the rewind crank lever rotates when the film wind lever is wound. If the rewind crank lever does not rotate, it means the film was not loaded properly. If such is the case, take out the film as illustrated on page 27 and reload the film.



FILM REWINDING

Since no further winding is possible when the film has reached the end, rewind the film immediately into the cartridge.

- As the exposed film is naked within the camera, the entire roll will be exposed and ruined if the cover is opened before rewinding.
- Be sure to put the lens cap on before rewinding the film.

1. Turn the film rewind ring to "R" from the "A" position.
2. Raise the rewind crank to its operating position and turn it clockwise, as shown by the arrow. Watch the rotation of the film transport indicator while rewinding the film. When the rotation stops.....then stop rewinding immediately.



3. Return the film rewind ring to "A".
 4. Turn the magazine opening key to the left.
 5. Open the back cover by pulling down the back cover lock outward.
6. Pull out the rewind crank as far as it will go and take out the film magazine or cartridge.
 - If the film is forcibly wound after all exposures have been completed, it will be impossible to rewind the film. It will have to be taken out in a darkroom.

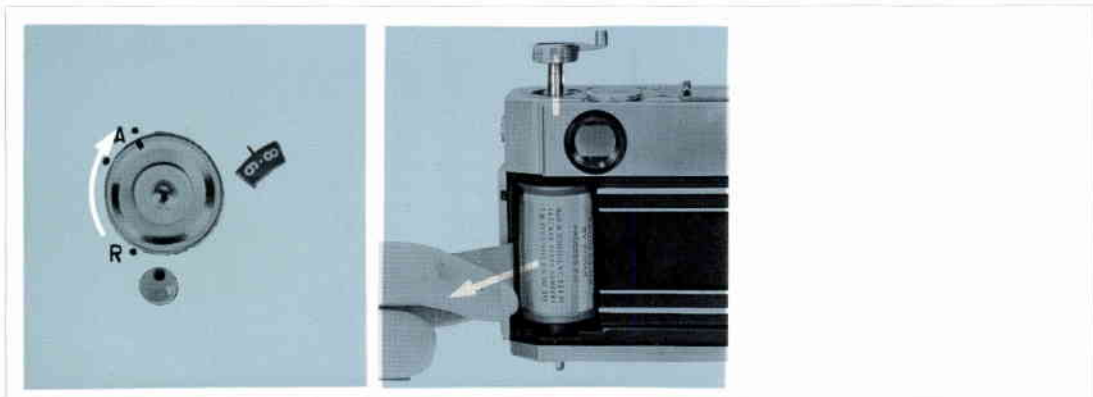

SELF-TIMER

When you are ready to photograph, wind the self-timer lever counter-clockwise as illustrated. This can be done before or after cocking the shutter. The timing device will start operating as soon as the shutter button is pressed... and the shutter will be actuated approximately 10 seconds later.

- Wind the self-timer more than 120°.
- Do not forget to wind the shutter. If this is neglected and only the self-timer is wound and the shutter button pressed, only the self-timer will act and the shutter will not click.
- Once you have cocked the self-timer, it cannot be released unless the shutter button is pressed.

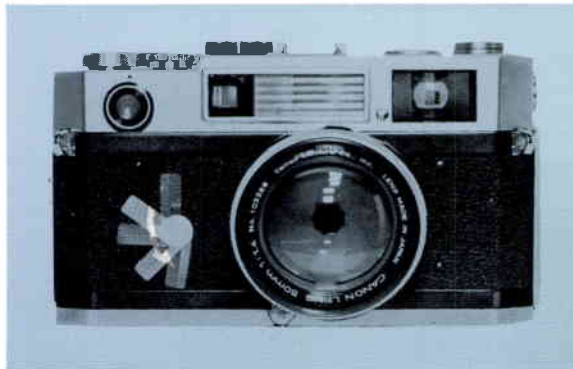

FLASH SYNCHRONIZATION



By connecting the flash unit and cord of speed-light to the flash socket, it is possible to synchronize the following shutter speeds.

Flash Bulb	Scope of Synchronization														
	1000	500	250	125	60	30	15	8	4	2	1	B	T	X	
FP type	○	○	○	○	○	×	○	○	○	○	○	○	○	○	×
M type	×	×	△	△	△	×	○	○	○	○	○	○	○	○	×
F type	×	×	×	×	×	○	○	○	○	○	○	○	○	○	×
Speed-light	×	×	×	×	×	○	○	○	○	○	○	○	○	○	○

The flash time lag is automatically adjusted when the shutter dial is set.

- A lens hood is necessary when taking flash pictures.
- The flash socket is JIS B-(Continental-) type.
- The M class bulb is made for lens shutter use. In cases where only the central part of the picture is necessary, it is also possible to use shutter speeds of 1/250, 1/125, and 1/60 markings.

SPECIAL CARE OF LENSES



How to Change Lenses

The lens mounting flange of the Canon 7S is equipped with both the Canon standard screw-in-mount and Canon special bayonet-mount M. To detach a screw-in type lens (other than the 50mm F0.95 lens) from the camera, hold the lens barrel at its base and turn counter-clockwise (illustrated by small arrow). To replace a lens, keep lens cap on but remove the dust cap from the lens. Turn the lens first counter-clockwise for half a turn to insure that the lens threads and the camera mounting flange do not cross. Next, turn clockwise (illustrated by large arrow) until the lens is securely in place.

- When mounting or dismounting a lens of 85mm or greater focal length, be sure to set it at the nearest footage setting.
- Do not change your lens in strong light. When changing your lenses, have the replacement lens at hand. Then quickly change the lenses in the shade...or use your shadow as a shield from direct light.

To detach a bayonet-mount-type lens (50mm F0.95) from the camera, turn the bayonet tightening ring counter-clockwise (illustrated by small arrow)... then the lens can be pulled out. To fit the lens into position, match the red mark of the tightening ring to the pin on the lens barrel. Insert the pin of the lens into the hole on the lens mounting flange... and turn the

tightening ring clockwise (illustrated by large arrow) while pushing in the lens.

- Traces of water bubbles cannot be entirely removed from glass used for high quality lenses because of the manufacturing process. Lens bubbles will not affect the sharpness of the picture.

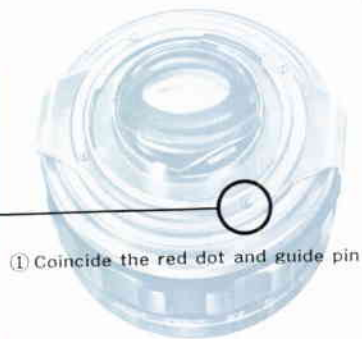
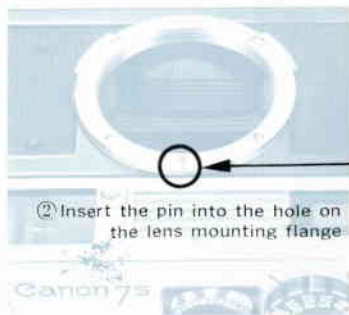
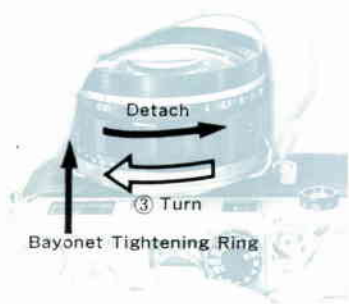

Distance Scale

The distance scale indicates the distance between the focused subject and the film. It is not necessary to check the scale for normal photography. However, it is necessary for infrared photography, which is explained later on, and for determining depth-of-field.

Film Plane Mark

This line gives you the exact position of the film plane in your camera. To focus on a subject without using the range-viewfinder, a measurement between the subject and the film plane is taken, then the distance index mark is set to the actual distance figure.

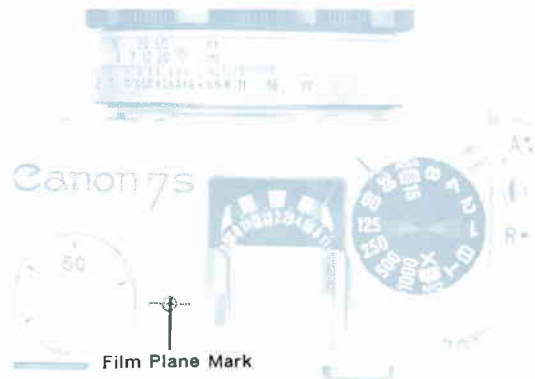
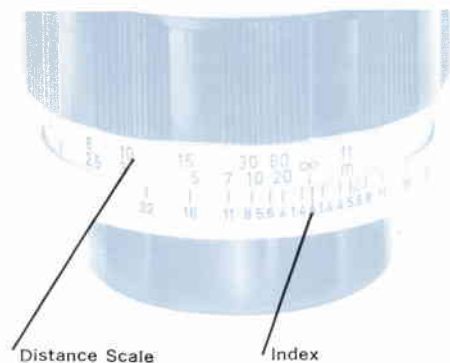

Infrared Photography

The letter "R" is on the depth-of-field scale of all Canon lenses. This is for infrared film. When using this film, focus in the normal way. Read off the distance of the subject you are focusing on as shown opposite the distance indicator mark on the lens distance scale. Turn the lens barrel until the distance reading is opposite the "R" mark. For example, when the subject you have focused on is 25-feet away, turn the lens barrel until the figure 25 is opposite the "R" mark. Your lens is now focused for infrared photography.

- The position of "R" is scaled according to the use of the standard of a film with the highest sensitivity of a wave length of about 8000 Å and infrared filter (for example, KODAK IR 135 film and WRATTEN 87 filter or JIS IR 77-87 filter). When you take picture using the plus X or ordinary panchromatic film with the WRATTEN 25 or red filter of SR 59-60 attached, the proper amount of correctional movement should be 1/3.

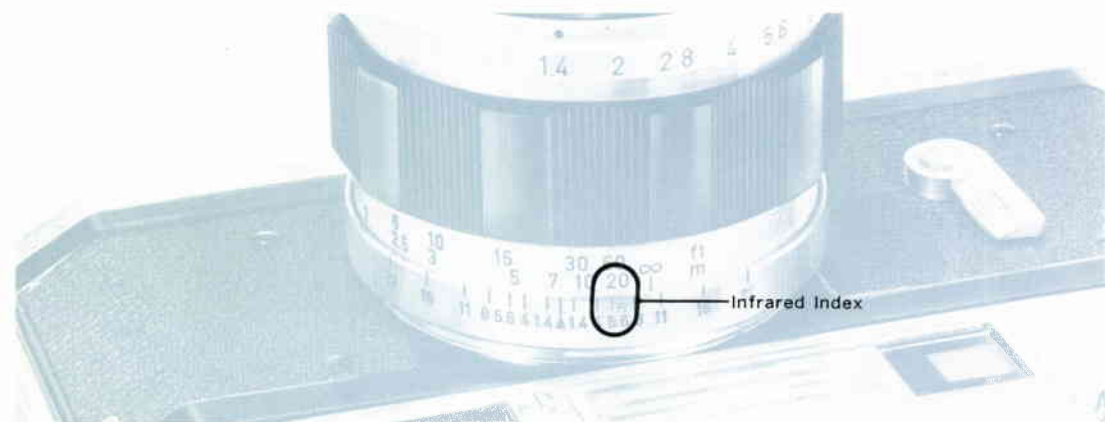

Depth-of-field Scale

The depth-of-field scale indicates the range of subjects which will be in sharp focus on the film. This range will vary with the following factors: The depth-of-field will be deeper the smaller the lens aperture, the shorter the lens focal length, and/or the further the distance of the subject. The depth-of-field will be shallower the larger the lens aperture, the longer the lens focal length, and/or the nearer the distance of the subject.



With a desired aperture stop of F 5.6, and the subject you have focused on at 25-feet, your camera will give you a sharply focused picture

from approximately 16-feet to 55-feet away from the camera. At F 11, you will get a sharp picture from 12-feet to infinity (∞).

F 5.6

50mm Lens

Depth-of-field 16ft.-55ft.
Focused at 25ft.



F 11

50mm Lens

Depth-of-field 12ft.- ∞
Focused at 25ft.

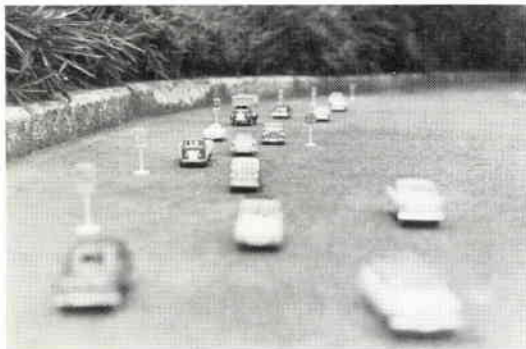

DOUBLE EXPOSURES

Canon 7S is not designed to take double exposures. However, it can be done by the following steps:

1. First turn the film rewind ring to "R" from "A" position.
2. While watching the film transport indicator, turn the film rewind crank to the right and stop when the film transport indicator has made about one-and-a-half turns.
3. Return the rewind ring to position "A".
4. Wind the winding lever, and you are ready to expose for the second time on the same film frame.
5. By repeating the same operation, multiple exposures can be obtained. By turning the film transport indicator two-and-a-half turns, you can make a double exposure on the film before your last one.
 - When the shutter button is released accidentally with the lens cap on, the film can be rewound by using this method.

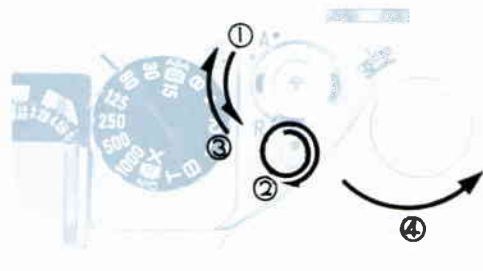
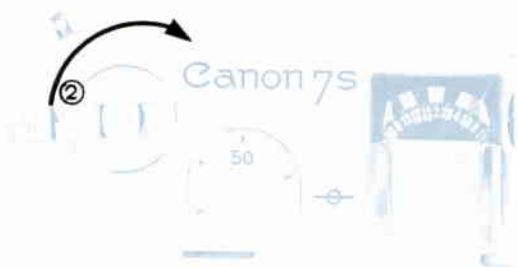

HOW TO LOAD FILM INTO THE MAGAZINE

The Canon Film Magazine V is designed to hold 5-1/4 feet (1.53 m) of 35mm film. It consists of three parts: center spool, inner shell, and outer shell.

1. To disassemble the magazine, place your finger on the button and turn the inner shell clockwise until both the inner shell and outer shell slots are super-imposed and the safety disengaged. Draw out the inner shell.



2. Insert the tapered end of the film into the larger width slit of the center spool. Face the emulsion (dull) side towards the spindle of the spool.

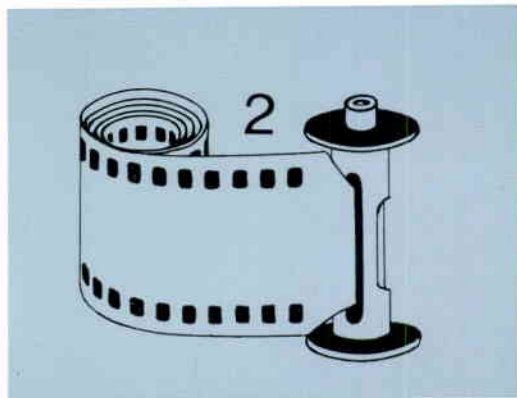

3. Wind 5-1/4 feet of film around the center spool moderately tight for 36 exposures... 3-1/4 feet for 20 exposures... 3 feet for 18 exposures. Do not touch the emulsion (dull) side with your fingers.
 4. To assemble the magazine, first insert the center spool into the inner shell, with the beginning of the film sticking out of the slot.
 5. Place the center spool into the inner shell and then place it into the outer shell. Inner and outer shell slots should be superimposed. Turn the inner shell counter-clockwise until it clicks into a locked position.
 6. When the film magazine is properly loaded and locked, draw out the film and trim it, as illustrated.
- This procedure must be done in a dark room or under safe lighting conditions.
 - Keep the magazine in its case when loaded.
 - Keep the magazine clean.

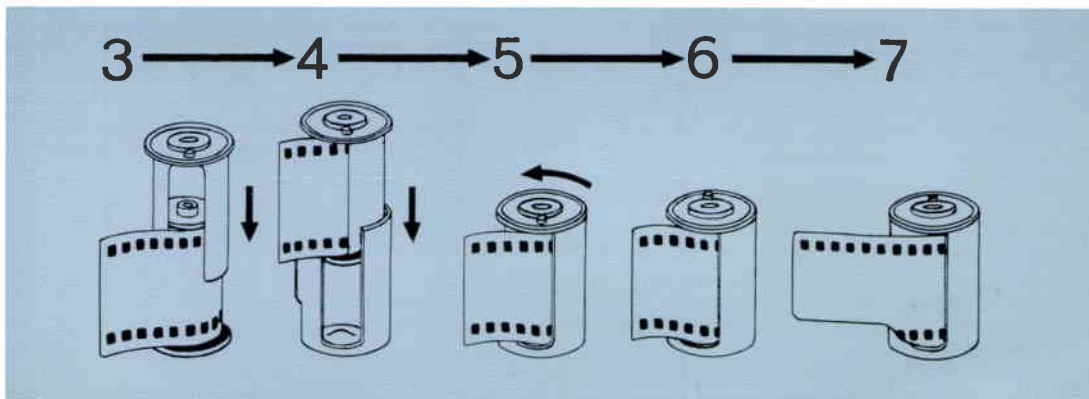

FILTERS

There are various types of 40mm (for 50mm F 1.8), 48mm (for 50mm F 1.4), 55mm (for 50mm F 1.2), and 72mm (for 50mm F 0.95) screw-in type filters used for special effects with black and white and color films.

FILTER FACTOR	TYPE	FILTER CHARACTERISTICS
1	UV (SL39 · 3C) for black & white and color	<ul style="list-style-type: none"> • Absorbs only ultra-violet rays. Especially effective at seaside, high mountains where there is much ultra-violet rays. Recommended for use in color photography.
1.5	Y1 (SY44 · 2C)	<ul style="list-style-type: none"> • Increases contrast of black & white film. Enhances clouds, lightening the blue sky. Brightens red and yellow. • Darkens blue, increases yellow and red values perceptibly. Good for contrasts in distant landscapes. • Makes strong contrasts. Renders day almost into night. May also be used with infrared film.
2	Y3 (SY50 · 2C)	
3	O1 (SO56 · 2C)	
6	R1 (SR60 · 2C)	
3	G1 (MG55 · C)	<ul style="list-style-type: none"> • Prevents red from turning radically into white. Lightens sky and face appropriately, and reflects the lightness of fresh greenery.
1	Skylight	<ul style="list-style-type: none"> • Acts to harmonize the blue sky and shade. • ND 4 reduces light values by 1/4, ND 8 by 1/8. No effects on the reproduction of colors of color film.
4	ND 4	
8	ND 8	
2	Color Conversion A	<ul style="list-style-type: none"> • Color film filter for conversion of color temperature when photographing tungsten type film under sunlight. • Color temperature conversion filter for use with daylight type film under tungsten light.
3	Color Conversion B	

Filter Factor Correction

When using the filter, exposure must be adjusted by adding the filter factor.

Adjustment Method 1

Changing the film speed

Divide the film speed by the filter factor.

This numerical value is the sensitivity when using the filter. Accordingly, correct the film speed.

- If the film speed is ASA 100 and the filter factor is 2, then it is $100 \div 2 = 50$. The film speed must be adjusted to ASA 50.



Adjustment Method 2

Changing the exposure

After adjusting the exposure in the ordinary manner, adjust the lens aperture or shutter speed according to the filter factor.

- The exposure is in a multiple relation, so that if the filter factor is 2, open the lens one stop. If the filter factor is 4, open the lens two stops.



INTERCHANGEABLE LENSES AND ACCESSORIES

Interchangeable Lenses

Canon lenses are held in the highest esteem by professional and discerning amateur photographers the world over for their unsurpassed, unique optical design and precision engineering. Before leaving the factory, each lens must meet exacting quality tests to insure the highest resolution, contrast, brilliance, and color fidelity. All lenses are Spectra-Coated to insure maximum color and tone balance, greater light transmission, and complete elimination of flare.



Today, a wide range of interchangeable lenses from 19mm to 1000mm are available to further enhance your Canon 7S. With Canon interchangeable lenses, you can photograph anything you wish. The addition of a telephoto lens, or wide-angle lens, makes your camera an extremely versatile one. You can photograph interesting subjects which previously might have been impossible. A whole new field view will be opened to you with Canon interchangeable lenses.

19 mm F 3.5
25 mm F 3.5
28 mm F 2.8
35 mm F 1.5
35 mm F 2
50 mm F 0.95
50 mm F 1.2
50 mm F 1.4
50 mm F 1.8
85 mm F 1.8
100 mm F 3.5
100 mm F 2
135 mm F 3.5

With Mirror Box 2 :
M 135 mm F 2.5
M 200 mm F 3.5
400 mm F 4.5
600 mm F 5.6
800 mm F 8
1000 mm F 11



Accessories

- Filters
(40mm, 48mm, 55mm, 72mm)
- Flash V-3
- Flash Quint
- Speedlite 100, 200
- Slidester 300
- Lens Hoods
- Film Magazine V
- Auto-ups
- Canon Release
- Copy Stand 3
- Finder (19mm, 25mm, 28mm)

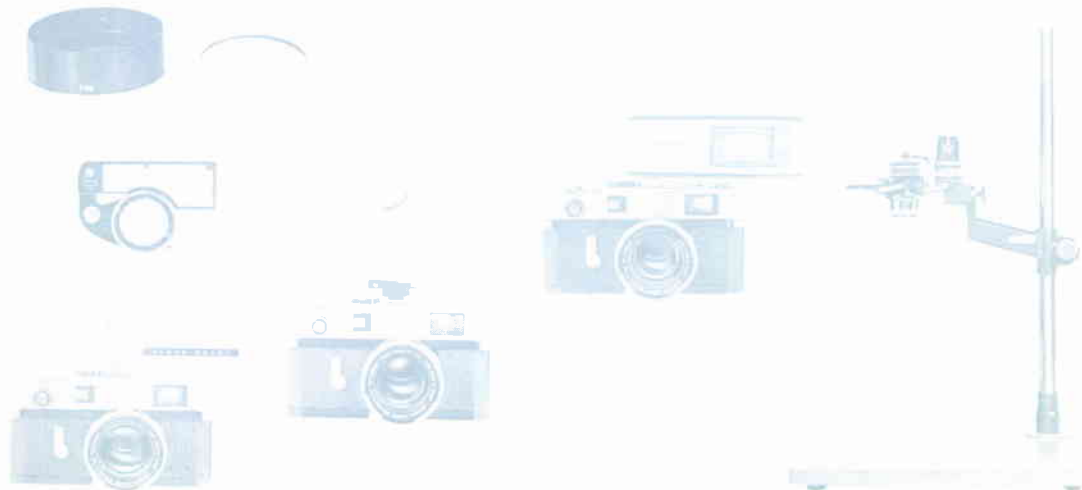

PRELIMINARY STEPS IN PHOTOGRAPHY

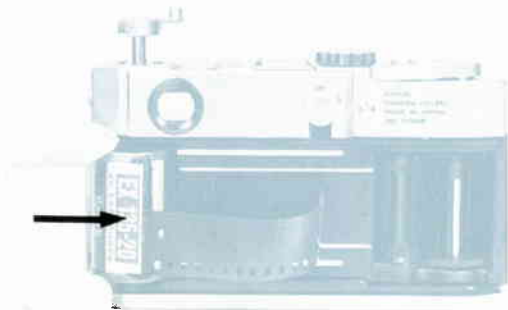

1. Load the film.



2. Set the film speed.

5. Determine the exposure with built-in meter.

6. Look through the viewfinder.





3. Remove the lens cap.



4. Advance the film.

7. Focus and compose the picture.



8. Press the shutter button gently.

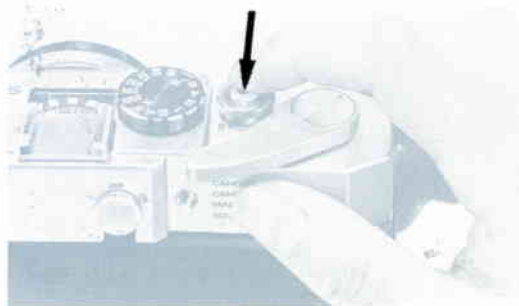

CANON CAMERA CO., INC.

3 Ginza 5-chome, Chuo-ku, Tokyo, Japan

CANON U.S.A., INC.

554 Fifth Avenue, New York, New York
10036, U.S.A.

CANON S.A. GENEVE

1, Rue de Hesse, Geneva, Switzerland

CANON LATIN AMERICA S.A.

Apartado 7022, Panama 5, Panama

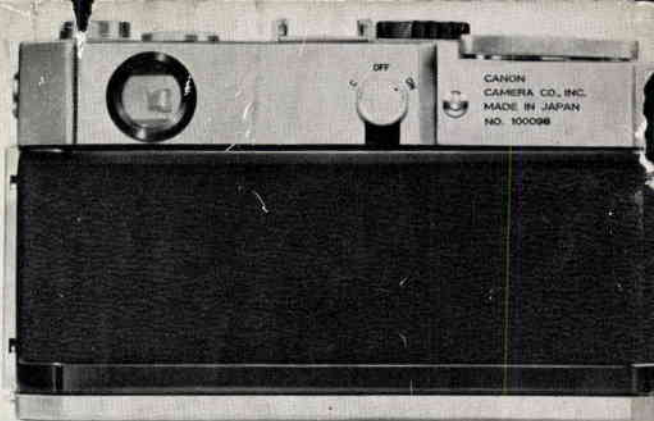

Free Manuals Download Website

<http://myh66.com>

<http://usermanuals.us>

<http://www.somanuals.com>

<http://www.4manuals.cc>

<http://www.manual-lib.com>

<http://www.404manual.com>

<http://www.luxmanual.com>

<http://aubethermostatmanual.com>

Golf course search by state

<http://golfingnear.com>

Email search by domain

<http://emailbydomain.com>

Auto manuals search

<http://auto.somanuals.com>

TV manuals search

<http://tv.somanuals.com>