

#45760

Canon EOS A2E



E

English Edition
INSTRUCTIONS

Download from [Www.Somanuals.com](http://www.Somanuals.com). All Manuals Search And Download.

Display Panel

This camera uses a large liquid crystal display panel to display shooting information. The diagram below shows all the information displayed simultaneously for explanation only. The LCD panel never actually appears like this.

- Shutter speed
- ISO film speed value
- dEP (Depth-of-field AE) indicator
- Custom Function No.
- CAL (Calibration) indicator
- Film rewind indicator

- Eye Controlled Focus mode indicator

- Battery check indicator

Film winding mode indicator

- Single exposure
- Continuous exposure
- High-speed continuous exposure
- Self-timer operation

Metering mode indicator

- Evaluative metering
- Spot metering
- Center-weighted average metering

- Film condition indicator
- Film-load check
- Film rewind completion

- Flash exposure compensation mode indicator

* A minute amount of battery power is used for the display even when the command dial is set to L.



- Aperture value
- AEB bracketing amount
- dEP point number
- Custom function setting
- Red-eye reduction function setting
- Beeper mode setting
- Calibration number
- Film rewind indicator

- Frame counter
- No. of preset multiple exposures
- No. of completed multiple exposures

- ISO indicator
- Auto exposure bracketing mode indicator
- Red-eye reduction mode indicator
- Multiple exposure mode indicator
- Beeper mode indicator
- Custom function mode indicator

Exposure display

- Exposure compensation amount
- AEB bracketing amount
- Flash exposure compensation amount
- Red-eye reduction lamp operation
- Film rewind indicator

- Manual exposure +/- indicator

Focus mode indicator

- One-shot AF
- AI Focus AF
- AI Servo AF
- Manual focus (all AF indicators extinguished)

Nomenclature

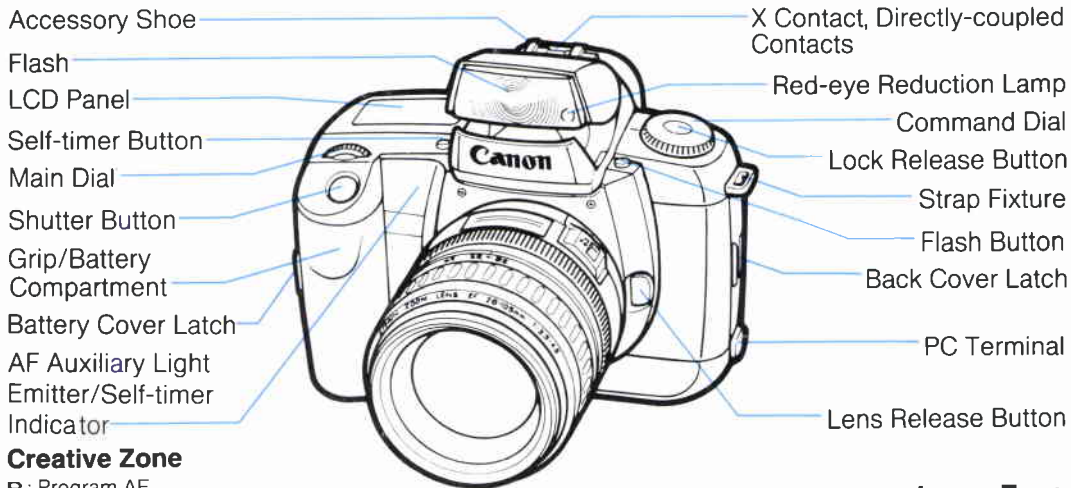

Creative Zone

- P : Program AE
- Tv : Shutter-priority AE
- Av : Aperture-priority AE
- M : Manual Exposure
- DEP : Depth-of-Field AE
- X : Flash Sync Mode
- CF : Custom Function Setting
- CAL : Calibration Mode
- L : Lock

Command Dial

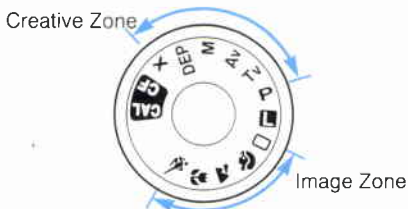
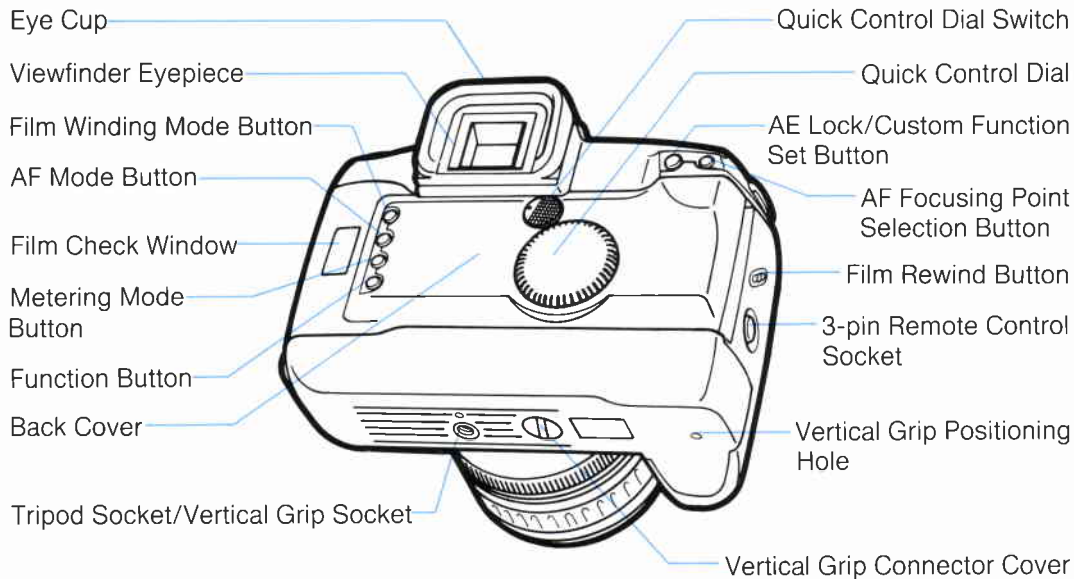

Image Zone

- : Full Auto
- 👤 : Portrait
- 🏞️ : Landscape
- 📷 : Close-up
- 🏃 : Sports

Nomenclature



Introduction

Thank you for selecting a Canon EOS camera. This camera is an autofocus SLR camera developed specifically to provide the high performance and flexible functionality required by professional and advanced photographers.

Features

1. World's first Eye Controlled Focus SLR. Select any of five focusing points in the viewfinder by simply looking at the desired AF frame.
2. Advanced AF sensor provides five focusing points plus high-speed autofocus on a par with the world's fastest AF SLRs.
3. High-performance shutter offers speeds all the way up to an action-freezing 1/8000 sec and flash synchronization up to 1/200 sec.
4. High-speed built-in motor drive with silent drive mechanism provides quiet film winding and rewinding while achieving a maximum continuous shooting speed of 5 frames/sec.
5. Multi-function built-in zoom flash covers wide-angle focal lengths to 28mm.

Please read these instructions carefully for a thorough understanding before taking pictures.

Attention

IMPORTANT INFORMATION

This camera will give optimum performance together with specially designed Canon EF lenses, flash units and other Canon brand accessories. It is possible that the use of incompatible lenses or other accessories may result in unsatisfactory performance or damage to your camera. We therefore suggest the use of Canon EF lenses and accessories. Damage to your Canon camera as a result of malfunction or improper connections caused by the use of incompatible products may void its warranty.

While reading this booklet, unfold the front and back flaps for easy reference to the camera's parts.



Viewfinder Information

The diagram below shows all the information displayed simultaneously for explanation only. The viewfinder never actually appears like this.

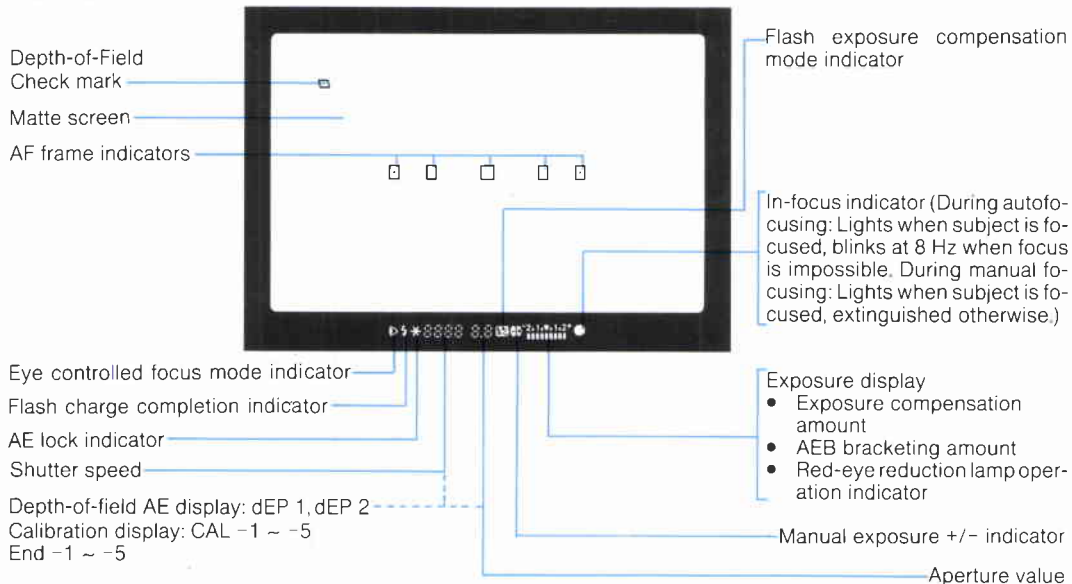

Table of Contents

Precautions	7	4. M (Manual exposure)	44
I Button & Dial Operation	8	5. DEP (Depth-of-Field AE)	45
II Camera Preparations	10	6. X (Flash sync mode)	48
1. Loading and Checking the Battery	10	7. Image Zone Shooting Modes	49
2. Lens Attachment	12	8. AE Lock	52
3. Film Loading and Rewind	13	9. AEB (Auto Exposure Bracketing)	53
4. Film Speed Setting	15	10. Multiple Exposure	55
5. Eye Controlled Focus Calibration	16	11. Bulb (Long Exposure) Operation	56
III Shooting Preparations	20	12. Self-timer Function	57
1. Using the Eye Controlled Focus Feature	20	V Custom Function Control	58
2. Other Methods of Selecting the AF Focusing Point	25	VI Reference	61
3. Selecting the Film Winding Mode	27	1. Exposure Warnings	61
4. Selecting the AF Mode	28	2. Program Line Characteristics	63
5. Selecting the Metering Mode	32	3. Function Combination Charts	65
6. Exposure Compensation	33	VII Accessories	66
7. Turning Off the Beeper	34	CAMERA CARE	72
8. Using the Built-in Flash	35	• Cleaning	72
9. Flash Exposure Compensation	39	• Liquid Crystal Display/Battery Notes	72
IV Shooting Modes & Functions	41	Specifications	74
1. P (Program AE)	41	Attaching the Strap	76
2. Tv (Shutter-priority AE)	42		
3. Av (Aperture-priority AE)	43		

Precautions

- 1) **This camera is not resistant to water** and should not be used outdoors in snow or rain. If accidentally dropped in water, contact an authorized Canon service facility. Keep the camera out of salt spray and protect it from excessive humidity. If used at the beach, clean it thoroughly afterward with a dry cloth.
- 2) Do not attempt to disassemble the camera yourself. Always take it to an authorized Canon service facility for repair.
- 3) Remove the battery if you do not expect to use the camera for about three weeks or longer.
- 4) When storing the camera, wrap it in a clean, soft cloth and place it in a cool, dry, dust-free place. Be sure to keep the camera out of direct sunlight, and away from "hot spots" such as the trunk or rear window shelf of a car. Avoid places where moth balls are used, and in extreme humidity, use a desiccant.
- 5) Carefully check the camera's operation after lengthy storage.
- 6) The battery may explode or cause burns if disassembled, recharged, shorted, exposed to high temperatures, or disposed of in fire.
- 7) Film passing through X-ray examinations at airports may be exposed and ruined even if loaded in the camera. Request a hand-checked inspection to avoid damage.
- 8) Aerosol spray dust removers are not recommended for the shutter curtain.
- 9) Condensation is a problem when bringing cold equipment into a warm room. If the autofocus optics cloud over, accuracy may be seriously affected. Before entering a warm room, put equipment in a plastic bag so that condensation forms on the outside of the bag.
- 10) Color reproduction may be adversely affected if film is left in the camera for a long time. Always develop exposed film promptly.
* Please see page 72 for camera care information.

I Button & Dial Operation

Command Dial



Turn to select the shooting mode. Setting the dial to the "L" position locks the dial and turns off the power. To

unlock, turn the dial while pressing the lock release button. Unlocking the dial turns on the camera.

Shutter Button



The shutter button has a two step construction. Press halfway (to the first step) to activate focusing and metering,

and press completely (to the second step) to release the shutter and make the exposure.

Main Dial

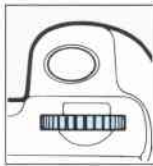

Use in conjunction with other buttons for operations such as selecting the focusing mode, film winding mode,

metering mode, or AF frame. Use alone for operations such as setting the shutter speed or shifting the program curve.

Quick Control Dial

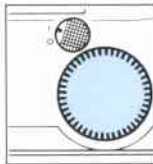

Use for operations such as selecting the aperture value in manual exposure mode and setting exposure compensation in AE or flash modes.

Quick control dial operation can be prohibited or enabled using the quick control dial switch.

Flash Button

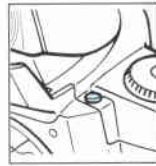

Press once to pop up the flash for flash shooting. In creative zone modes, press again to activate flash exposure

compensation mode and operate the main dial or quick control dial to set the compensation amount. When finished using the flash, press it down manually to the retracted position.

Self-timer Button

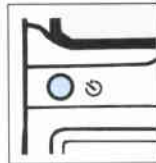



Press to display the "⌚" symbol in the LCD panel and activate the self-timer. To cancel the self-timer, press

again.

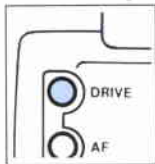
Film Winding Mode Button



Press this button and operate the main dial to select the desired film winding mode

(□ : Single exposure,  : Continuous exposure,  : High-speed continuous exposure). The selected mode is displayed in the LCD panel.

AF Mode Button

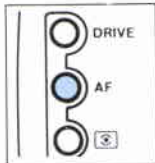



Press this button and operate the main dial to select the desired focus mode (One-shot AF, AI Servo AF).

The selected mode is displayed in the LCD panel.

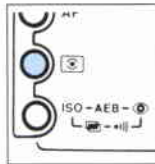
Metering Mode Button



Press this button and operate the main dial to select the desired metering mode ( : Evaluative metering,

 : Spot metering,  : Center-weighted average metering). The selected mode is displayed in the LCD panel.

Function Button

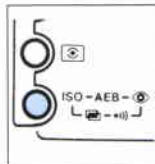

Each press switches between AEB setting mode, red-eye reduction mode, multiple exposure mode and

ISO film speed setting mode. After selecting the desired mode, operate the main dial to select the desired setting. The selected mode and setting are displayed in the LCD panel.

AE Lock/Custom Function Setting Button



Pressing this button locks in the current exposure reading and allows re-composition without changing the exposure setting. When the command dial is set to the custom function mode, use this button to set or cancel the selected custom function.

AF Focusing Point Selection Button

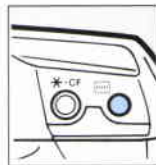

Press to enter AF focusing point selection mode. After pressing, operate the main dial to select the desired focusing point.

II Camera Preparations

1. Loading and Checking the Battery

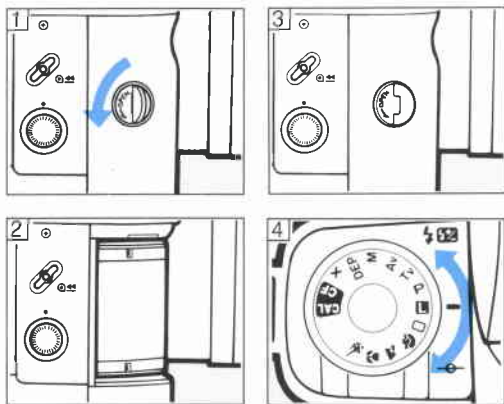



This camera uses a single 6V lithium battery (2CR5). Load the battery as follows.

- 1) Fold out the battery cover latch tap and turn it counterclockwise to open the battery compartment.
- 2) Insert the battery so that its terminals enter the camera first.
- 3) Replace the battery cover and turn the latch clockwise to firmly lock it in place.
- 4) Press the lock release button and turn the command dial to a position other than "L". Check the battery indicator displayed in the LCD panel.

If the entire battery indicator () is displayed, the battery is in good condition.

All buttons used for changing camera functions are equipped with a six-second timer. After pressing and releasing the button, the operation mode activated by the button remains active for six seconds. During this time period, necessary information for the selected mode is displayed in the viewfinder and LCD panel.

- If nothing at all is displayed in the LCD panel, the battery may be inserted backwards. Remove the battery and reinsert it correctly.
- When not using the camera, set the command dial to  to prevent unnecessary battery depletion or accidental shutter release.

 : When the battery indicator is only half full, have a new battery handy.

 : When the battery indicator is empty, replace the battery with a new one.

 If the empty battery indicator is blinking, refer to page 72.

Battery Life (Number of film rolls)

Temperature	Flash not used	50% flash use	100% flash use
Normal (+20°C/68°F)	40 rolls	20 rolls	12 rolls
Low (-20°C/-4°F)	15 rolls	9 rolls	—

- Data based on Canon's Standard Test Method (Using a new battery and 24 exposure film; Lens: EF 28~105mm f/3.5-4.5 USM; Shutter speed: 1/1000 sec; Lens focus driven from infinity to closest shooting distance and back, then shutter button held at halfway position for six seconds before each frame; Film winding mode: Single exposure; AF mode: One-shot AF; Eye controlled focus: ON).
- Stated values include camera operation when no film is loaded.

2. Lens Attachment

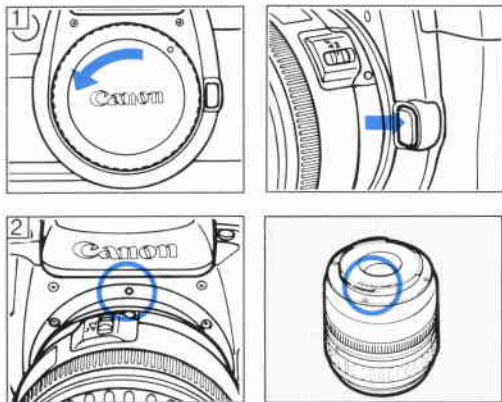

- 1) Remove the camera body cap.
 - 2) Align the red dots on the lens and camera body, then rotate the lens clockwise until it locks in place with a click.
- To remove the lens, press the lens release button while turning the lens counter-clockwise.

When the lens is removed from the camera, place it face down on a stable surface to prevent damage to the lens surface and electronic contacts.

3. Film Loading and Rewind

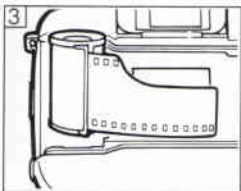
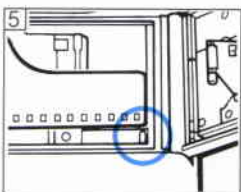
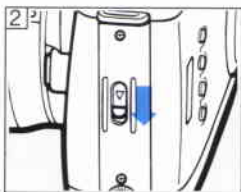
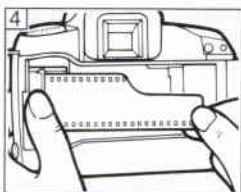
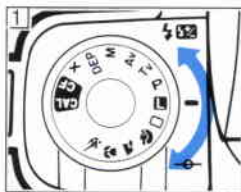

- 1) Move the command dial to a position other than “L”.
 - 2) Open the back cover by sliding the back cover latch down.
 - 3) Insert the film cartridge with the flat end facing up and the bottom end entering the camera first.
 - 4) While holding down the film cartridge, carefully pull the film tip across until it reaches the orange mark.
 - 5) After checking that the film lies flat and that the tip is aligned with the orange mark, close the back cover.
- The film automatically advances to the first frame, the frame counter shows “1” and the film cartridge symbol () is displayed in the LCD panel.
 - If the film cartridge symbol blinks, the film is not loaded correctly. Reload the film. If the film is not loaded correctly, the shutter will not release when the shutter button is pressed.

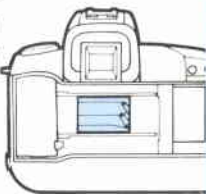

The shutter curtain operates with extremely high precision and can be easily damaged if touched. When loading or unloading film, be careful not to touch the shutter curtain accidentally with your finger or the tip of the film.

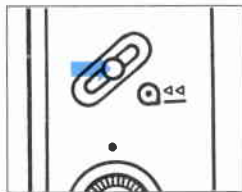

Due to the emission of infrared light by the camera's optical film perforation detector, infrared film cannot be used in this camera.



Film rewind

The film automatically rewinds after the last frame is shot. During rewinding, the LCD panel's frame counter counts down, and the focusing point display and exposure compensation amount bars flash to indicate that the film is rewinding. When rewinding is completed,  blinks in the LCD panel. After confirming that  is blinking, open the back cover and remove the film.

Rewinding film in mid-roll

Press the film rewind button to rewind the film. After the film is wound completely into the film cartridge,  blinks in the LCD panel.

4. Film Speed Setting

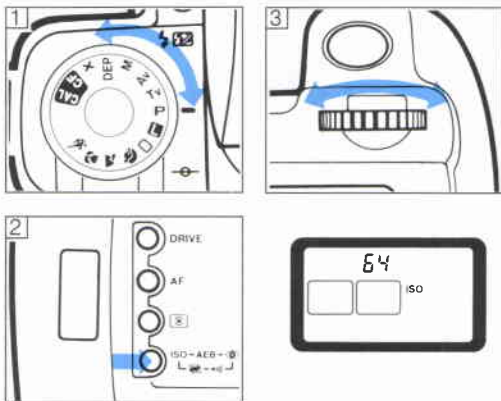

Automatic film speed setting

When DX film is loaded, the film speed is set automatically according to the DX code on the film cartridge.

- The automatic film speed setting range is ISO 25~5000.
- If non-DX film is loaded, the ISO indicator blinks in the LCD panel.
- The currently set film speed can be checked by pressing the function button so that ISO is displayed in the LCD panel.

Manual film speed setting

The film speed can be set manually when using non-DX film or when you wish to set a film speed other than the DX-coded film speed.

- 1) Set the command dial to a creative zone position.
- 2) Press the function button until ISO is displayed in the LCD panel.
- 3) Turn the main dial to the desired film speed.
 - * The setting is completed when the shutter button is pressed halfway or after six seconds elapse.

Film speed display

The manual film speed setting range is ISO 6~6400.

6, 8, 10, 12, 16, 20, 25, 32, 40, 50, 64, 80, 100, 125, 160, 200, 250, 320, 400, 500, 640, 800, 1000, 1250, 1600, 2000, 2500, 3200, 4000, 5000, 6400

5. Eye Controlled Focus Calibration

What is Eye Controlled Focus?

Eye Controlled Focus is a new feature which enables the camera to automatically detect which part of the viewfinder screen you are looking at and focus the subject at that point. The ability to focus where you look makes the camera virtually an extension of your eye.

Calibration

Before using Eye Controlled Focus (refer to page 20), it is necessary to calibrate the camera for your individual eye characteristics (pupil size, use of contact lenses or eyeglasses, etc.). Calibration numbers 1~5 are provided, allowing up to five different calibration settings to be stored in the camera for different usage conditions, which can be classified by photographer or shooting location, for example.

- Hold the camera in the normal (horizontal) picture-taking position during the calibration procedure.
- If performing the calibration procedure outdoors, keep the sun behind you.

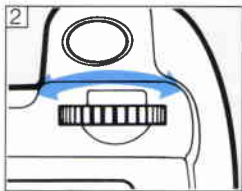
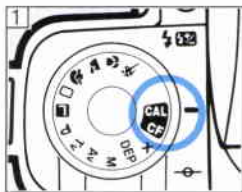

- 1) Turn the command dial to the " **CAL** " position.
 - "OFF" is displayed in the LCD panel.
- 2) Turn the main dial to the desired calibration number.
 - Numbers which do not yet contain calibration settings blink in the display.
- 3) While holding the camera to your eye, look at the blinking far right AF frame in the viewfinder and press the shutter button.
 - A double beep tone is heard.*
- 4) Next, look at the blinking far left AF frame in the viewfinder and press the shutter button again.
 - A double beep tone is heard, and "End" and the calibration number are displayed in the viewfinder and LCD panel to indicate that the calibration procedure is completed.
 - If the calibration procedure is interrupted for a short period and the red AF frame in the viewfinder goes out, press the shutter button halfway and start again from step 3.

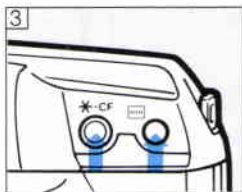

- 3) Simultaneously press the AE lock button and AF focusing point selection button.
- The calibration number blinks in the LCD panel to indicate that the calibration setting is deleted.

If you have problems with the calibration operation, or if you find it difficult to select the desired AF frame in Eye Controlled Focus mode, refer to the supplement supplied with this instruction book.

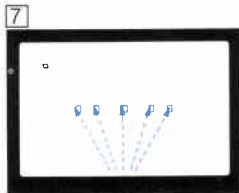
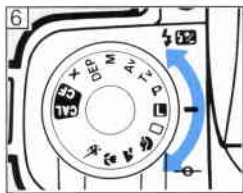



- 6) Turn the command dial to the desired shooting mode.
 - “▶” appears in the viewfinder and “◀▶” appears in the LCD panel.
- 7) Look through the viewfinder and press the shutter button halfway while looking at the desired AF frame.
 - The selected AF frame lights red in the viewfinder and focusing is carried out for that focusing point.
- 8) To cancel Eye Controlled Focus mode, set the calibration display to “OFF” in step 5.
 - The camera enters automatic focusing point selection mode.

When the camera is held vertically in Eye Controlled Focus mode, the focus mode temporarily switches to automatic focusing point selection mode and “▶” disappears from the viewfinder.



If the camera cannot determine which AF frame you are looking at:

- 1) "  " blinks in the viewfinder and the camera automatically switches to automatic focusing point selection mode (refer to page 26) to select the focusing point. After focusing is completed, "  " will continue to blink in the viewfinder but it is still possible to use the eye-controlled depth-of-field check function. To return to Eye Controlled Focus mode, remove your finger from the shutter button and then press it again halfway.
- 2) Different shooting locations can conceivably change the state of your eye and affect Eye Controlled Focus operation. When shooting in a location with a different light source, perform the calibration procedure again at the calibration number you are currently using (refer to page 16). Each time a calibration is performed the camera "learns" the different states of your eye, improving the Eye Controlled Focus operation.

- If calibration is repeated at the same calibration number but with a different eye, or if successive calibrations are performed by different people, Eye Controlled Focus operation may become unstable or misoperation may occur. If this happens, delete the setting at the problematic calibration number (refer to page 18) and repeat the calibration procedure.

Eye controlled depth-of-field check

When using the Eye Controlled Focus feature in a creative zone shooting mode, you can check the depth of field (close down the aperture) by looking at the depth-of-field check mark in the upper left corner of the viewfinder within 5 seconds after the subject is focused in One-shot AF mode. The aperture opens back up when you remove your finger from the shutter button.

As long as Eye Controlled Focus mode is on, eye controlled depth-of-field check is possible even when the focusing point is selected manually (refer to page 25).

- Eye controlled depth-of-field check must be carried out within 5 seconds after focusing is completed. If more than 5 seconds elapse, refocus the subject and then look at the depth-of-field check mark within 5 seconds.

2. Other Methods of Selecting the AF Focusing Point

Manual focusing point selection

At any time in creative zone, you can manually select the desired AF frame in the viewfinder using the main dial.

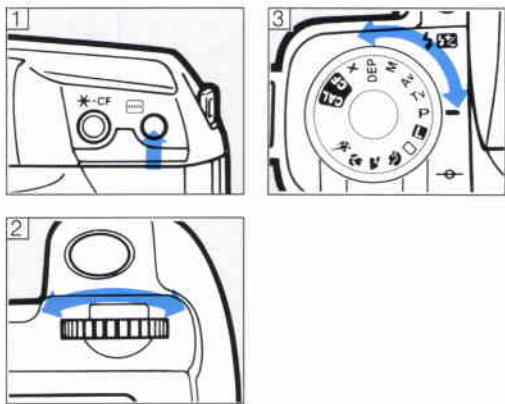

- 1) Press the AF focusing point selection button.
 - The currently selected AF frame lights red in the viewfinder and the AF focusing point indicator blinks in the LCD panel.
- 2) Turn the main dial to select the desired focusing point.
 - The selected AF frame lights red in the viewfinder and the AF focusing point indicator blinks in the LCD panel.
 - The setting is completed when the shutter button is pressed halfway or after six seconds elapse.
- 3) Turn the command dial to a creative zone setting.
 - The camera focuses using the manually selected AF focusing point.

Automatic focusing point selection

The camera automatically selects the AF frame according to the shooting conditions.

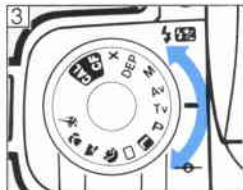
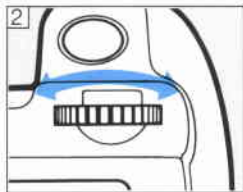
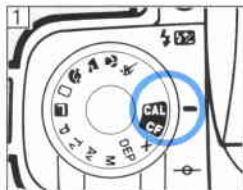

- 1) Turn the command dial to the " **CAL** " position.
- 2) Turn the main dial until the LCD panel displays "OFF."
- 3) Turn the command dial to a creative zone setting.
- 4) Press the AF focusing point selection button.
 - The currently selected AF frame lights red in the viewfinder and the AF focusing point indicator blinks in the LCD panel.
- 5) Turn the main dial to select all five focusing points.
 - All five AF frames light red in the viewfinder and the AF focusing point indicators blink in the LCD panel.
 - The setting is completed when the shutter button is pressed halfway or after six seconds elapse.
- 6) Turn the command dial to the desired shooting mode and take a picture.
 - The camera automatically selects a focusing point and focuses the subject.

3. Selecting the Film Winding Mode

Three film winding modes are available: single exposure mode, continuous exposure mode and high-speed continuous exposure mode.

- Refer to page 65 for details concerning relationships between AF and film winding modes.

(Single exposure)

The film advances one frame after each picture is taken. After taking a picture, let up on the shutter button slightly to prepare for the next exposure. This mode is usually combined with One-shot AF mode.

 (Continuous exposure)

Pictures are taken continuously as long as the shutter button is held pressed.

 (High-speed continuous exposure)

Pictures are taken continuously at high speed as long as the shutter button is held pressed.

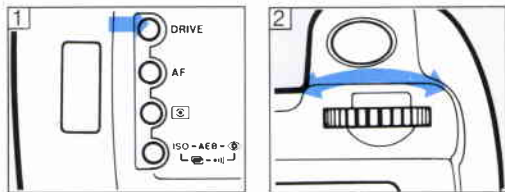

- 1) Press the film winding mode button.
- 2) Turn the main dial so the desired film winding mode indicator appears in the LCD panel.

* The setting is completed when the shutter button is pressed halfway or after six seconds elapse.

4. Selecting the AF Mode

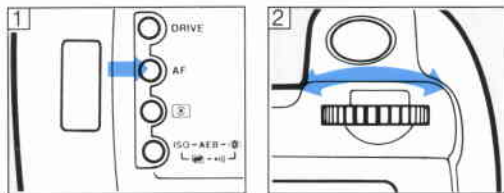

When the subject is focused in One-shot AF mode, the corresponding AF frame lights red in the viewfinder, and the in-focus indicator lights up. At the same time, the shutter speed and aperture value are displayed in the viewfinder and LCD panel.

If you remove your finger after pressing the shutter button to the halfway position, the in-focus indicator will disappear, but the camera timer will keep the viewfinder and LCD panel displays lit for six seconds.

Three types of autofocusing are available: One-shot AF, AI Servo AF and AI Focus AF. AI Focus AF is active only in Full Auto () mode. Manual focusing is also available.

- 1) Press the AF mode button. If you release the button, the timer will allow AF mode selection for six seconds.
- 2) Operate the main dial so the desired AF mode indicator appears in the LCD panel.
 - * Make sure the lens' focus mode switch is set to AF for autofocus shooting.

One-shot AF

Use this mode with stationary subjects. The shutter will not release until the subject is focused. Exposure is determined when the subject is focused. By keeping the shutter button pressed to the halfway position, the focus and exposure settings remain locked, allowing you to recompose the picture as desired.

- The shutter will not release if the in-focus indicator is still blinking. Try refocusing the subject at a different position or use manual focusing (refer to page 31).

AI Servo AF

Use this mode when taking pictures of moving subjects. The lens focuses the subject continuously with the selected focusing point while the shutter button is pressed halfway. AI Servo's predictive focus function* can track subjects moving toward or away from the camera. When the camera is set for automatic focusing point selection, AI Servo AF operation is as follows —

* Predictive focus function

Predictive focus detects the distance and speed of the subject and then predicts the subject position so that the subject will be sharply focused the instant the exposure occurs. Shutter release has priority over AF operation in creative zone modes, and AF has priority in image zone modes.

When Eye Controlled Focus is ON: The camera continuously focuses and tracks the subject using only the selected focusing point.

* The selected focusing point lights red in the viewfinder when the camera detects your line of sight.

When Eye Controlled Focus is OFF: First cover the subject with the center focusing point and press the shutter button halfway to focus the subject. After that, if the subject moves away from the center focusing point while the shutter button is still pressed halfway, the camera automatically shifts to one of the other focusing points and continues tracking the subject.

- Exposure is determined immediately before the shutter is released.
- In AI Servo AF mode, the in-focus indicator does not function.
- Focus lock cannot be used in this mode.

AI Focus AF

This mode is active only when the command dial is set to Full Auto () mode. The camera automatically selects One-shot AF or AI Servo AF depending on the subject.

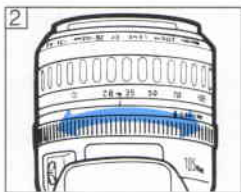
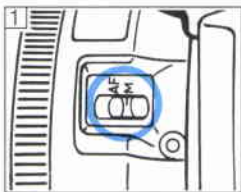

Manual Focusing

- 1) Set the lens' focus mode switch to M.
 - * All AF mode indicators in the LCD panel go out.
 - 2) Turn the lens' manual focusing ring until the subject appears sharp.
 - * The in-focus indicator lights to indicate that the subject is in focus.
- If manual focusing is set when the camera is in Eye Controlled Focus mode,  disappears from the viewfinder.
 - After autofocusing is completed in One-shot AF mode when using a USM lens equipped with a distance scale window, the lens can be manually focused directly without switching the lens focus mode switch.

5. Selecting the Metering Mode

Three metering modes are available: evaluative metering, spot metering and center-weighted average metering.

 (Evaluative metering)

Use this mode for general subjects. The exposure setting is based on the focusing point in use, taking into account such factors as subject size, position, overall lighting level, front lighting and back lighting.

 (Spot metering)

This mode limits the metering area to the central part of the viewfinder (approx. 3.5% of the image area). Use this mode when there is a big difference in brightness between the main subject and the background, or for subjects that require precise measurement, such as close-up photography.

 (Center-weighted average metering)

Metering is averaged over the entire scene with emphasis placed on the center area.

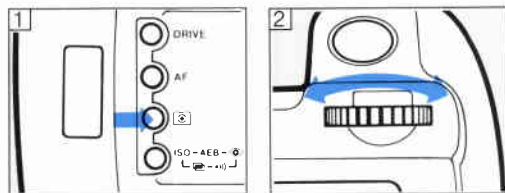

1) Press the metering mode button.

2) Operate the main dial so the desired metering mode indicator appears in the LCD panel.

6. Exposure Compensation

When taking pictures in an AE shooting mode, you can use the quick control dial to vary the exposure according to the subject conditions. Exposure can be compensated up to ± 2 stops in 1/2-stop increments.

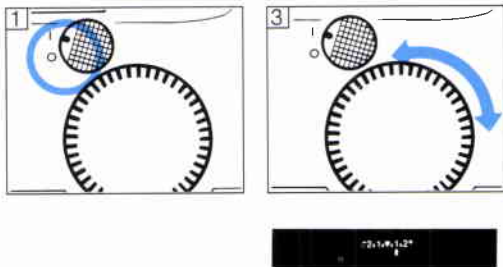

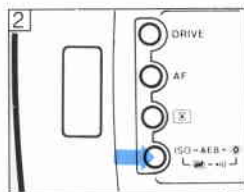
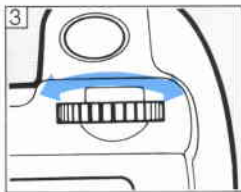
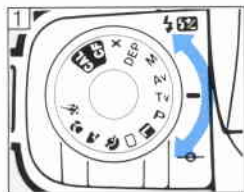

- 1) Set the quick control dial switch to **I**
- 2) Focus the subject and confirm the exposure.
- 3) Turn the quick control dial to set the desired exposure compensation amount.
 - * The compensation amount is displayed in the LCD panel and viewfinder. "+" compensation overexposes the subject and "-" compensation underexposes it.
 - * After setting the desired compensation amount, it is a good idea to set the quick control dial switch to **O** to prevent accidental alteration of the setting.
- 4) Take the picture.
 - To cancel exposure compensation, repeat step 3 to return the compensation amount to 0, then set the quick control dial switch to **O**.

7. Turning Off the Beeper



The beeper tone used to indicate self-timer operation in creative zone modes can be turned off and on as follows.

- 1) Set the command dial to a creative zone mode.
- 2) Press the function button so that  appears in the LCD panel.
- 3) Turn the main dial to select "1" or "0" in the LCD panel.

- 1: Beeper tone on.  is displayed in the LCD panel.
- 0: Beeper tone off.  is not displayed in the LCD panel.

8. Using the Built-in Flash

The built-in flash zooms automatically to adjust the flash illumination angle according to the lens focal length (28mm, 50mm or 80mm).

The flash can be used in any mode. It is particularly useful for low-light, backlit, or fill-in flash situations.

- 1) Press the flash button to pop up the flash.
- 2) Press the shutter button halfway to confirm that “⚡” lights in the viewfinder.
- 3) Take the picture.
 - * To retract the flash, push it down gently by hand.

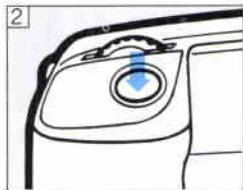
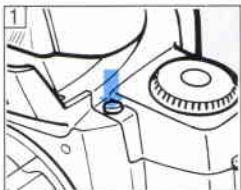



When the red-eye reduction function is set and the shutter button is pressed halfway, the bar indicators in the LCD panel and viewfinder light up for about 1.5 seconds. When these indicators go out, press the shutter button completely to take the picture.



Light from the built-in flash may be blocked when using the following lenses. When using such a lens we recommend using a dedicated external flash unit.

- Large aperture lenses such as the EF 20~35mm f/2.8L and EF 28~80mm f/2.8-4L.
- Super-telephoto lenses such as the EF 300mm f/2.8L and EF 600mm f/4L.

Red-eye Reduction Function



The subject's eyes may appear red in flash photos due to a phenomenon called "red eye," caused by light reflecting from the retina.

When the red-eye reduction function is set and the shutter button is pressed halfway, the red-eye reduction lamp lights to illuminate the subject before the flash fires to reduce the size of the subject's pupils and minimize the chance of red eye. Red-eye reduction can be set in creative zone modes and in Full Auto (), Portrait () and Close-up () image zone modes.

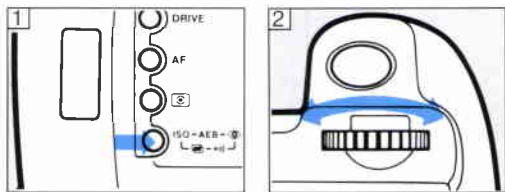
- Although setting is possible, red-eye reduction will not function in Sports () and Landscape () modes.



- 1) Press the function button so that “  ” appears in the LCD panel.
- 2) Turn the main dial to select “1” or “0” in the LCD panel.

- 1: Red-eye reduction on.  is displayed in the LCD panel.
- 0: Red-eye reduction off.  is not displayed in the LCD panel.

- A lens hood attached to the lens will block light from the built-in flash. Always remove the lens hood when using the built-in flash.
- The built-in flash and an external flash cannot be used together.
- The built-in flash will not operate when an external flash unit or cover is attached to the accessory shoe.
- If the built-in flash is held down while the flash button is pressed,  will blink in the LCD panel and the camera will stop operating. This is not a malfunction. Press the shutter button halfway to resume normal operation.

Flash Shooting Distance Range (using the EF 28~105mm f/3.5-4.5 USM)

(m/ft)

ISO	28mm		80mm	
	Negative film	Slide film	Negative film	Slide film
100	1~5.3/3.3~17.4	1~3.7/3.3~12.1	1~5.3/3.3~17.4	1~3.8/3.3~12.5
400	1.2~10.5/3.9~34.4	1.6~7.4/5.2~24.3	1~10.7/3.3~35.1	1.2~7.6/3.9~24.9

X-sync Shutter Speed and Aperture Settings

Shooting mode	X-sync shutter speed	Aperture value
P (Program AE)	Automatically set to 1/60~1/200 sec according to ambient light level.	Flash aperture automatically set according to TTL program (for built-in flash).
Tv (Shutter-priority AE) M (Manual exposure)	Manually set to any shutter speed of 1/200 sec or slower.*	Automatically set according to ambient light level and shutter speed.
Av (Aperture-priority AE)	Automatically set between 30 sec and 1/200 sec according to ambient light level and set aperture value.	Manually set to desired aperture.
X (Flash sync mode)	Manually set to 1/200, 1/125, 1/90 or 1/60 sec.	Manually set to desired aperture.

* If a shutter speed faster than 1/200 sec is set, the camera automatically sets the shutter speed to 1/200 sec.

9. Flash Exposure Compensation

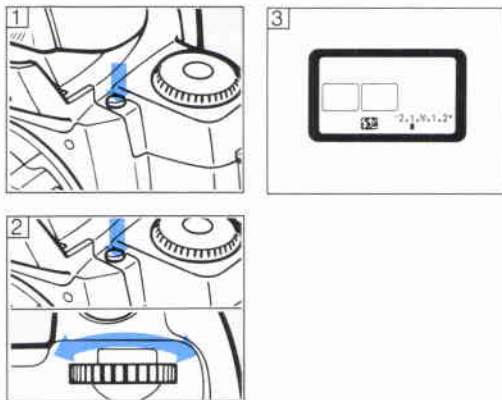

This function lets you vary the automatic flash exposure level of the built-in flash and EOS external flash units. The flash exposure can be compensated up to ± 2 stops in 1/2-stop increments.

- 1) Press the flash button to pop up the built-in flash.
- 2) Press the flash button again and turn the main dial or quick control dial to set the desired compensation amount.
 - * To use the quick control dial, set the quick control dial switch to I .
 - *  lights in the LCD panel.
 - * The flash exposure compensation amount is displayed in the LCD panel and the viewfinder. "+" indicates overexposure compensation and "-" indicates underexposure compensation.
- 3) Press the flash button again to complete the flash exposure compensation setting. The flash exposure compensation amount disappears from the LCD panel and viewfinder and the AE exposure compensation display appears.

- After setting the desired compensation amount, it is a good idea to set the quick control dial switch to **0** to prevent accidental alteration of the setting.
- To check the flash exposure compensation amount, pop up the flash and press the flash button.
- Flash exposure compensation remains set until manually canceled. To cancel, repeat steps 2 and 3 to reset the flash exposure compensation amount to 0, then set the quick control dial switch to **0**.
- Flash exposure compensation and AE exposure compensation can be set independently and used together.

Flash Exposure Compensation Priority Chart

When flash exposure compensation (FEC) is set on the camera and/or an EOS external flash unit, the setting priority ranking is as follows:

	FEC set on the camera only	FEC set on the flash only	FEC set on both the camera & flash
Macro Ring Lite ML-3	Camera setting	Not possible	—
160E	Camera setting	Not possible	—
200E	Camera setting	Not possible	—
300EZ	Camera setting	Not possible	—
420EZ	Camera setting	Not possible	—
430EZ	Camera setting	Flash setting	Flash setting

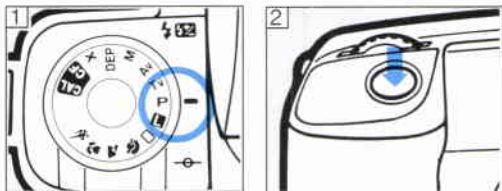

In this mode, the camera automatically sets both the shutter speed and aperture according to the subject brightness.

- 1) Set the command dial to P.
- 2) Press the shutter button halfway to focus the subject and confirm the exposure.
- 3) Press the shutter button completely to take the picture.

Program shift function

When taking pictures in Program AE or Depth-of-Field AE mode, you can “shift the program” to change the set shutter speed and aperture value combination while maintaining the same exposure.

After pressing the shutter button halfway, turn the main dial until the desired shutter speed/aperture combination is displayed.

- The adjustment clears after one exposure or continuous exposure sequence.
- Program shift cannot be used with the built-in flash or external dedicated flash units.



2. Tv (Shutter-priority AE)

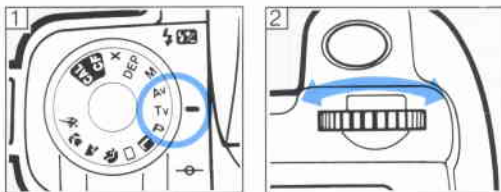

In this mode, you set the shutter speed and the camera automatically sets the aperture according to the lighting conditions.

- 1) Set the command dial to Tv.
- 2) Turn the main dial to the desired shutter speed.
- 3) Press the shutter button halfway to focus the subject and confirm the exposure.
- 4) Press the shutter button completely to take the picture.

Shutter speed display

The following shutter speeds are available.
8000 6000 4000 3000 2000 1500 1000 750
500 350 250 200 180 125 90 60 45 30 20 15
10 8 6 4 3 2 0"7 1" 1"5 2" 3" 4" 6" 8" 10" 15"
20" 30"

- 200 is available only when using flash.



3. Av (Aperture-priority AE)

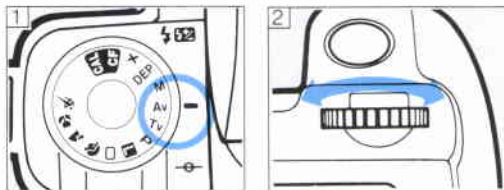

In this mode, you set the aperture and the camera automatically sets the shutter speed according to the lighting conditions.

- 1) Set the command dial to Av.
- 2) Turn the main dial to the desired aperture.
- 3) Press the shutter button halfway to focus the subject and confirm the exposure.
- 4) Press the shutter button completely to take the picture.

Aperture value display

The following aperture settings are available.

1.0 1.2 1.4 1.8 2.0 2.5 2.8 3.5 4.0 4.5 5.6 6.7 8.0
9.5 11 13 16 19 22 27 32 38 45 54 64 76 91

- The actual aperture range available differs depending on the lens.



4. M (Manual exposure)

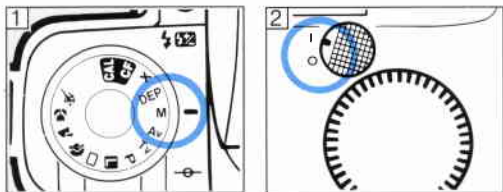

Correct exposure

Use this position as the reference point when determining exposure.



Overexposure



Underexposure



This mode lets you set both the shutter speed and aperture. Use this mode when you need complete control of exposure for creative effects or when using a hand-held exposure meter. The main dial sets the shutter speed and the quick control dial sets the aperture.

- 1) Set the command dial to M.
- 2) Set the quick control dial switch to I .
- 3) Turn the main dial to the desired shutter speed and the quick control dial to the desired aperture.
- 4) Press the shutter button halfway to focus the subject and determine the correct exposure using the exposure display.
- 5) Press the shutter button completely to take the picture.

Adjust the exposure according to the exposure level indicator in the viewfinder and LCD panel.

5. DEP (Depth-of-Field AE)

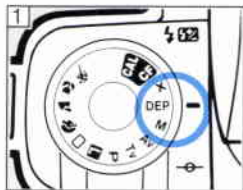

This mode places everything between two freely set points in the foreground and background within the zone of focus.

- 1) Set the command dial to DEP.
- 2) Select the desired AF frame using the manual focusing point selection procedure (refer to page 25).
- 3) Place the AF frame on the nearest point you want in focus (point A), then press the shutter button.
 - * When the in-focus indicator and "dEP 1" light up in the viewfinder, remove your finger from the shutter button.
- 4) Place the AF frame on the farthest point you want in focus (point B), then press the shutter button again.
 - * When the in-focus indicator and "dEP 2" light up in the viewfinder, remove your finger from the shutter button.
 - * Points A and B can be reversed if desired.



- 5) Compose the picture and press the shutter button halfway to confirm the exposure.
 - * The correct exposure value for the designated depth of field and the corresponding shutter speed are displayed in both the viewfinder and LCD panel.
 - * If you remove your finger from the shutter button the display changes to "dEP" and the aperture value.
 - * If desired you can change the aperture/shutter speed combination by turning the main dial (refer to page 41).
- 6) Press the shutter button completely to take the picture.

If the aperture value blinks, the desired depth of field cannot be obtained. Use a wide-angle lens or move farther from the subject and repeat steps 3 through 5.

- To cancel depth-of-field AE in mid-operation, turn the command dial to another position.
- When using a zoom lens, do not zoom the lens after setting the first point.
- For greater depth of field, we recommend using a wide-angle lens.
- For shallow depth of field, place both points A and B on the same subject. This method is effective for blurring the foreground and background when shooting portraits. Use a telephoto lens for best effect.
- Flash cannot be used effectively in depth-of-field AE mode. Use of flash will provide the same result as using flash in Program AE mode.
- If Eye Controlled Focus or automatic focusing point selection mode is set, the center AF frame is used for focusing.
- If Eye Controlled Focus is on when depth-of-field AE is set,  temporarily disappears from the viewfinder display.

6. X (Flash sync mode)

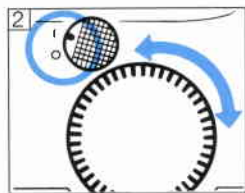
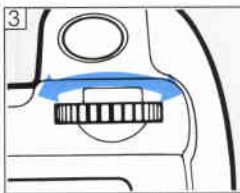
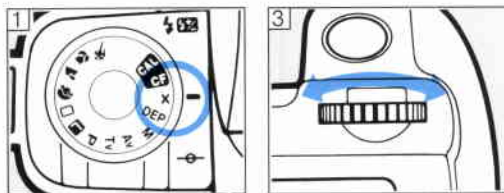

[Attention]

The diagram on the right shows the contact points of the camera's PC terminal. please note that if an external flash unit with opposite polarity is attached to the camera, the flash will not operate.



Use this mode for flash photography using a non-dedicated external flash unit (such as a studio strobe) connected to the camera's PC terminal or accessory shoe. Shutter speed and aperture settings are the reverse of manual exposure operation, with the X-sync shutter speed (1/200, 1/125, 1/90 or 1/60 sec) set with the quick control dial and the aperture value set with the main dial.

- Before use, be sure to check the synchronous shutter speed range of the external flash unit.
- 1) Set the command dial to X.
 - 2) Set the quick control dial switch to I, then turn the quick control dial to the desired X-sync shutter speed.
 - 3) Turn the main dial to set the desired aperture.
 - 4) Take the picture.

7. Image Zone Shooting Modes

Image zone shooting modes automatically set all camera functions such as metering, film winding and AF mode to the optimum settings appropriate for the selected mode.

- When using an external flash unit in an image zone mode, the picture may not turn out as expected. Do not use an external flash unit with image zone modes.
- If the shutter speed set by the image zone mode falls below "1/focal length of the lens in use," the beeper sounds (2 beeps per second) to warn of possible blurring due to camera shake.
- Refer to page 65 for the function settings in each mode.

☐ (Full Auto)

This setting allows you to take pictures in any situation with point and shoot simplicity. Focusing, exposure and film winding are all set automatically.

- Red-eye reduction operation is possible with the built-in flash (refer to page 36).
- Eye Controlled Focus cannot be used.

AF mode automatic switching function

In Full Auto mode, the camera senses the subject movement and automatically sets One-shot AF if the subject is stationary or AI Servo AF if the subject is moving (refer to page 29).

- When the camera switches to AI Servo AF mode, the in-focus indicator does not function.
- Once the camera switches to AI Servo AF mode, it will not switch back to One-shot AF mode.

(Portrait)

Set this mode to create a sharply focused subject against a blurred background for flattering portraits.

- Hold the shutter button down to take pictures continuously.
- Red-eye reduction operation is possible with the built-in flash (refer to page 36).

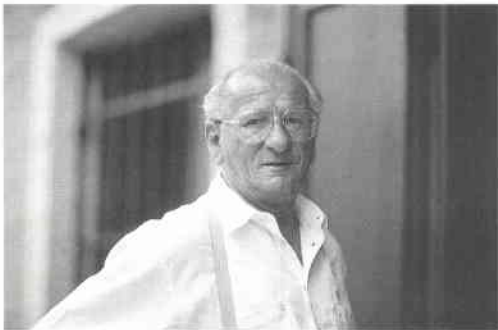

(Landscape)

Set this mode for vivid landscape pictures with everything sharply focused from near to far. When using a zoom lens, set the lens to a wide-angle position for best effect.



(Close-up)

Set this mode to use the lens' built-in macro function and take striking close-ups of small objects such as flowers and insects. When using a zoom lens, set the lens to telephoto for greatest magnification.

- The light from the flash may be partially blocked by the lens at distances closer than 1 m/3.3 ft.
- For high-magnification close-ups, we recommend using a macro lens.



(Sports)

Use this setting for taking pictures of sporting events or other situations with fast-moving subjects. The camera continuously focuses as you follow the subject with the shutter button pressed halfway.



- Pictures can be taken continuously by holding the shutter button pressed.

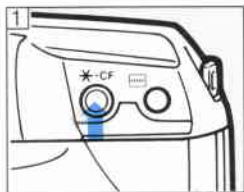

8. AE Lock



When you press the AE lock button, * lights in the viewfinder to indicate that AE lock is set. Once * appears the exposure remains locked even if you release the AE lock button. AE lock is available in P, Tv, Av and DEP shooting modes.

- When the film winding mode is  or , the same exposure setting is used for all continuous exposures.

AE lock operation for different AF focusing point selection and metering mode combinations



	Manual focusing point selection	Eye Controlled Focus/Automatic focusing point selection
Evaluative metering	Locks metered value based on selected AF focusing point	Locks metered value based on selected AF focusing point after focusing is completed with the shutter button pressed halfway
Spot metering	Locks metered value based on center AF focusing point	
Center-weighted average metering	Locks metered value based on center AF focusing point	

9. AEB (Auto Exposure Bracketing)

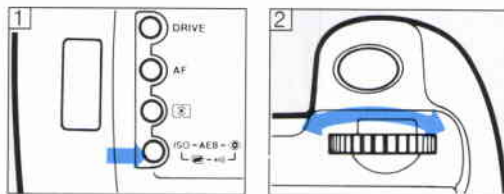
Use auto exposure bracketing in AE and manual exposure modes to take a sequence of pictures at different exposures. When this function is set, the exposure is shifted (bracketed) for three successive pictures in the sequence: correct exposure → underexposure → overexposure. The bracketing amount can be set in 1/2-stop increments up to ± 2 stops from the metered exposure value.



Auto exposure bracketing is particularly effective when using slide film, which produces noticeably different results with even small exposure variations.

- When this function is combined with continuous exposure () or high-speed continuous exposure (), holding the shutter button pressed automatically takes three exposures in sequence while shifting the exposure for each picture.

- 1) Press the function button so that AEB appears in the LCD panel.
- 2) Turn the main dial to set the desired bracketing amount.

* The bracketing amount is shown in the LCD panel as both a graphic level display and a numerical value. If "0.5" is set, for example, three pictures are taken in the following sequence: correct exposure (± 0 stop), underexposure (-0.5 stop) and overexposure ($+0.5$ stop).



Auto exposure bracketing is carried out in each mode as follows:

P: Both the shutter speed and aperture value are shifted.

Av, DEP, M: Only the shutter speed is shifted.

Tv, X: Only the aperture value is shifted.

* The bracketing amount is also displayed in the viewfinder.

3) Set the command dial to the desired shooting mode and take pictures.

- To cancel auto exposure bracketing, repeat steps 1 and 2 to reset the bracketing amount to 0.
- Auto exposure bracketing is automatically canceled when the battery is replaced.
- Auto exposure bracketing cannot be used in bulb mode or when using flash.
- Auto exposure bracketing can be used in X mode with flash units connected through the PC terminal.
- The exposure level blinks in the LCD panel and viewfinder display during auto exposure bracketing operation.

If you wish to shift the bracketed exposure values toward over- or underexposure, you can add exposure compensation using the quick control dial. In this case the LCD panel may not display the correct values, but exposures will be made correctly.

10. Multiple Exposure

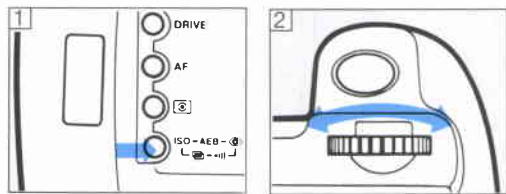

Up to nine exposures can be made on one frame by presetting the number of multiple exposures with the main dial.

- 1) Press the function button so that  appears in the LCD panel.
- 2) Turn the main dial to set the desired number of exposures in the frame counter display area.
- 3) Take pictures.

-  blinks in the LCD panel while multiple exposures are being taken.
- To cancel multiple exposure mode in mid-operation, repeat steps 1 and 2 to set the frame counter to a blank display.
- When the preset number of multiple exposures is completed, the film automatically advances to the next frame and multiple exposure mode is canceled.

Helpful Hints

When taking multiple exposures on a single frame, you should decrease the exposure value for each exposure using exposure compensation (refer to page 33).

Number of multiple exposures	Compensation amount
2 exposures	-1.0
3 exposures	-1.5
4 exposures	-2.0

The above values should be used only as a guide. The actual compensation amount required depends on the shooting conditions and should be determined by prior testing.

11. Bulb (Long Exposure) Operation

Use this mode when long exposures are required, such as for pictures of night scenes and fireworks displays. The shutter stays open for as long as you press the shutter button.

Mount the camera on a tripod to prevent camera movement during exposure.

- The remote switch 60T3 (sold separately) can be connected to the camera's remote control socket for use in starting and stopping the bulb exposure. For details, read the instructions supplied with the 60T3.
- Battery life during bulb exposure is approximately 6 hours with a new battery.

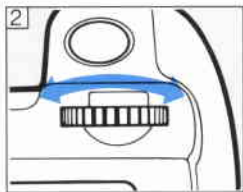
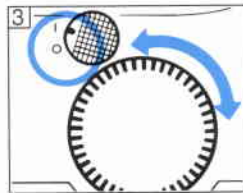
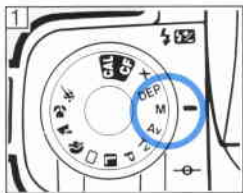

- 1) Set the command dial to M.
- 2) Turn the main dial to change the shutter speed until "buLb" appears in the LCD panel. "buLb" is the next position after 30".
- 3) Set the quick control dial switch to I, then turn the quick control dial to the desired aperture.
- 4) Press the shutter button for the desired length of time.
 - * The viewfinder display extinguishes during the exposure.
 - * The word "buLb" blinks in the LCD panel during the exposure.

12. Self-timer Function

When using the self-timer, place the camera on a tripod or a steady surface. The picture is

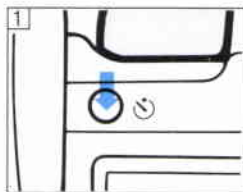

Pressing the shutter button with your eye away from the viewfinder may allow light to enter the viewfinder and trick the metering system into setting a wrong exposure. To prevent this from happening, remove the eye cup from the eyepiece and cover the eyepiece with the cover provided on the strap before pressing the shutter button.

taken approximately 10 seconds after you press the shutter button.

- 1) Press the self-timer button.
 - *  appears in the LCD panel.
 - 2) Compose the picture and press the shutter button halfway to focus the subject and set the exposure.
 - 3) Press the shutter button completely.
 - * A beeper tone is heard and the picture is taken after a 10-second delay. The self-timer lamp starts blinking two seconds before the picture is taken.
 - 4) When finished using the self-timer, press the self-timer button again to cancel the self-timer mode.
- When using the self-timer with Eye Controlled Focus mode turned on, press the shutter button while looking through the viewfinder.
 - Pressing the self-timer button before the picture is taken will cancel self-timer mode and stop the countdown.

V Custom Function Control

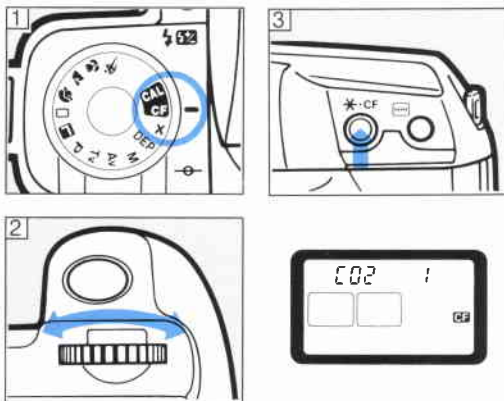

The number in the LCD panel alternates between 0 and 1 each time the custom function set button is pressed.

- 1: Sets the custom function to the custom setting.
- 0: Resets the custom function to the standard setting.

Sixteen types of custom functions are provided to let you customize the camera according to your personal preferences and shooting style. Set the custom functions as follows.







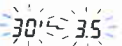

- 1) Set the command dial to **CF**.
- 2) Turn the main dial to select the desired custom function number.
- 3) Press the custom function set button to change the setting in the LCD panel to "1".
 - * To reset the selected custom function to the standard setting, press the custom function set button to change the number in the LCD panel to "0".
- 4) Turn the command dial to a position other than **CF**.
 - * "**CF**" is displayed in the LCD panel.

Custom Functions (when the number in the LCD panel is 1)





CF1:	Sets automatic film rewind to high-speed mode.	Film is rewound at approximately twice the speed of standard rewind mode.
CF2:	Leaves the film leader outside the cartridge after rewinding.	This function is useful if you develop your own film or plan to reload partially-used film after rewinding in mid-roll.
CF3:	Cancels automatic film speed setting with DX-coded film.	Use this function when you wish to compensate the film speed or manually set effective film speeds obtained from independent testing.
CF4:	Switches the autofocus start function from the shutter button to the AE lock button.	When this function is set, autofocus will not start when the shutter button is pressed halfway. The AE lock button simultaneously locks the exposure setting and initiates autofocus. This custom function cannot be used together with CF6 or CF11.
CF5:	Changes single exposure operation to allow the next exposure only after the shutter button is fully returned to the off position.	Setting this function ensures that a fresh meter reading will be taken before each exposure.
CF6:	Changes the function of the AE lock button to temporarily stop autofocusing operation.	Use this function when you wish to temporarily fix the focus at a certain point when shooting sports or action with AI Servo AF. This custom function cannot be used together with CF4.
CF7:	Prohibits firing of the AF auxiliary light during autofocusing.	This function is useful to keep the AF auxiliary light from appearing in other people's pictures in situations where many people are taking pictures of the same scene.
CF8:	Prohibits cancellation of multiple exposure mode after a single frame.	Use this function when making multiple exposures on successive frames to keep from having to reset multiple exposure mode for every frame. To check the current frame number, keep the shutter button held pressed after the last exposure in a multiple exposure sequence.

CF9:	Fixes the shutter speed at 1/200 sec when using flash.	When shooting indoors with flash in aperture-priority AE mode, the camera is likely to set a slow shutter speed which can result in blur caused by camera shake. This custom function prevents this from happening by fixing the shutter speed at 1/200 sec regardless of the lighting conditions.
CF10:	Prohibits superimposed AF frames in the viewfinder.	When a subject is focused, the AF frame used for focusing normally lights red in the viewfinder. Setting this custom function stops this from happening.
CF11:	Adds a depth-of-field check function to the AE lock button.	Setting this function lets you use the AE lock button to check the depth of field after the subject is focused and exposure is set. This custom function cannot be used together with CF4.
CF12:	Enables shooting with the mirror locked up.	When the shutter button is pressed completely in self-timer mode, the mirror moves up immediately and the picture is taken two seconds later.
CF13:	Cancels the metering timer function. • Except in DEP mode.	Setting this function cancels the timer which continues metering for six seconds after your finger is removed from the shutter button, thus saving battery power.
CF14:	Changes the sync timing of the built-in flash from first curtain sync to second curtain sync.	Flash firing synchronizes with the travel of the second shutter curtain, providing a more natural effect when using slow shutter speeds.
CF15:	Links spot metering to the selected AF frame (only when the AF frame is selected by the user).	Setting this function lets you carry out spot metering at the same point as the selected AF frame, eliminating the need to change the scene composition during metering.
CF16:	Cancels automatic flash reduction control.	Setting this function cancels the automatic flash reduction control which normally operates with backlit subjects, thus preventing the underexposure which can occur with subjects backlit by a strong light source such as the afternoon sun.

- If both CF4 and CF6 are set, only CF4 is used.
- If both CF4 and CF11 are set, only CF4 is used.
- Custom function settings operate only in creative zone shooting mode.

Shooting mode	Blinking display warning	Meaning	Corrective action	
P (Program AE)	 30'' 3.5	Shutter speed 30'' and maximum aperture of the lens in use.	Subject is too dark.	Use flash.
	 8000 2.2	Shutter speed 8000 and minimum aperture of the lens in use.	Subject is too bright.	Use an ND filter.
Tv (Shutter-priority AE)	 125 3.5	Maximum aperture of the lens in use.	Subject will be underexposed.	Turn the main dial to a slower shutter speed.
	 125 2.2	Minimum aperture of the lens in use.	Subject will be overexposed.	Turn the main dial to a faster shutter speed.
Av (Aperture-priority AE)	 30'' 8.0	Shutter speed 30''.	Subject will be underexposed.	Turn the main dial to a larger aperture.
	 8000 8.0	Shutter speed 8000.	Subject will be overexposed.	Turn the main dial to a smaller aperture.
DEP (Depth-of-field AE)	 60 5.6	Calculated aperture value.	Desired depth of field cannot be obtained.	<ol style="list-style-type: none"> 1) Move farther away from the subject and set the near and far points again. 2) When using a zoom lens, set to the wide-angle position.
	 30'' 3.5	Shutter speed 30'' and maximum aperture of the lens in use.	Subject is too dark.	Use flash. (Same result as using Program AE.)
	 8000 2.2	Shutter speed 8000 and minimum aperture of the lens in use.	Subject is too bright.	Use an ND filter.

Exposure Warnings When Using Flash

Shooting mode	Blinking display warning	Meaning	Corrective action	
P (Program AE)	 200 2.2	When using daylight fill-in flash, shutter speed 200 and minimum aperture of the lens in use.	Overall image will be overexposed.	Do not use flash.
Tv (Shutter-priority AE)	 200 2.2	Minimum aperture of the lens in use.	Overall image will be overexposed.	Do not use flash.
	 200 3.5	Maximum aperture of the lens in use.	Background will be underexposed.	Subject will be properly exposed.
Av (Aperture-priority AE)	 200 5.6	Shutter speed 200.	Overall image will be overexposed.	Turn the main dial to a smaller aperture.
	 30 5.6	Shutter speed 30".	Background will be underexposed.	Turn the main dial to a larger aperture.

2. Program Line Characteristics

This camera is equipped with advanced "Intelligent Program AE" which chooses the best shutter speed/aperture combinations taking the lens' focal length and minimum and maximum apertures into account. The following graphs show the program lines for a typical lens.

Program Characteristics

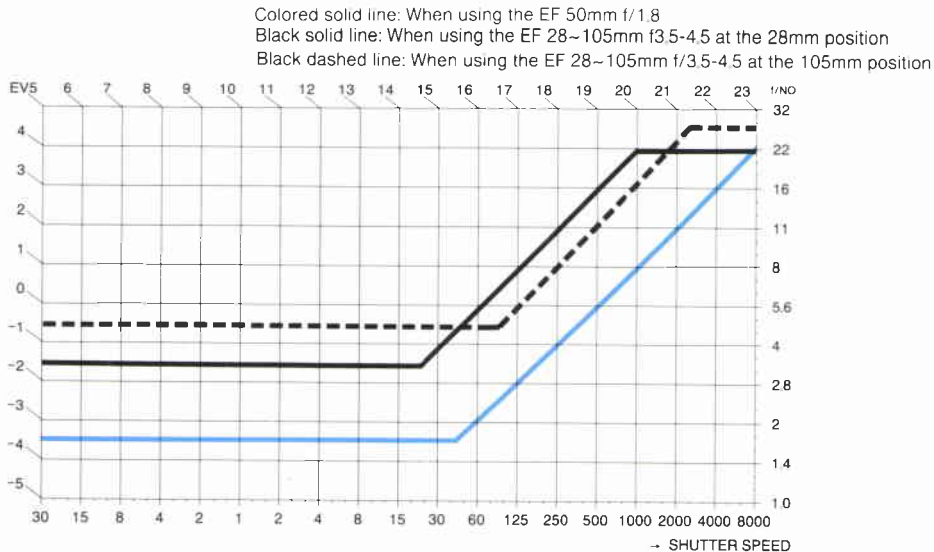

Program Shift Characteristics

* ● indicates the shutter speed/aperture combinations with program shift.

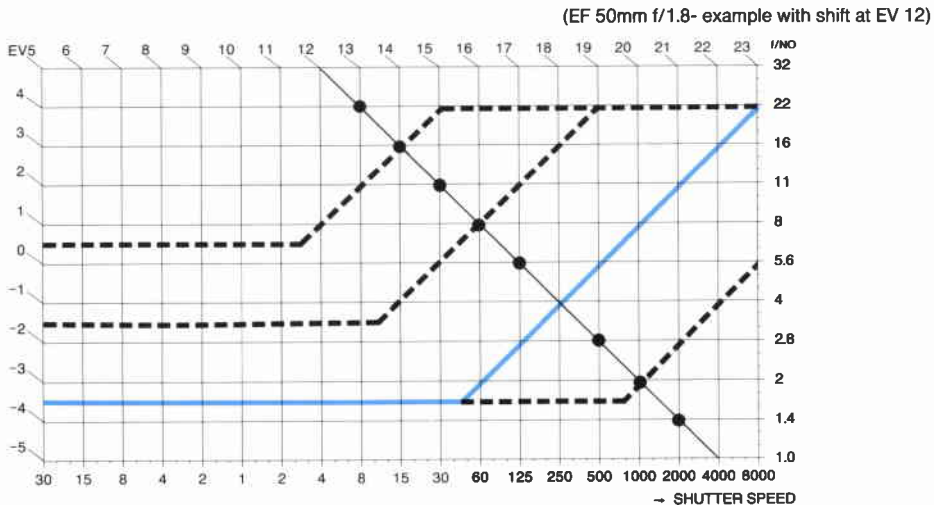

3. Function Combination Charts

Image Zone Mode Function Combinations

Shooting mode	AF mode		AF focusing point selection		Film winding mode		Metering mode		Built-in flash	
	One-shot	AI Servo	Auto-matic	Eye Controlled Focus	Single	Continuous	Evaluative	Spot	Auto-firing	OFF
(Full Auto)	(automatic switching)		●		●		●			●
(Portrait)	●		●	●		●	●			●
(Landscape)	●		●	●	●		●			●
(Close-up)	●		●	●	●		●			●
(Sports)		●	●	●		● Hi	●			●

AF and Film Winding Modes

Film winding mode	AF mode	One-shot	AI Servo
(Single)		AF lock and AE lock take place simultaneously on AF completion. The shutter releases only after AF completion.	AF follows the subject and the exposure is determined at the instant of shutter release.
(Continuous)		AF lock and AE lock take place simultaneously on AF completion, then continuous exposure is activated. (Approx. 3 fps maximum.)	AF follows the subject and the exposure is determined at the instant of shutter release. AF is adjusted during the exposure sequence to follow the subject. (Approx. 3 fps maximum.)
(High-speed continuous)		Same as above. (Approx. 5 fps maximum.)	Same as above. (Approx. 3 fps maximum.)

VII Accessories

The accessories described in this section are sold separately.

Vertical Grip (VG10)

This dedicated grip is equipped with a shutter button, AE lock button, main dial, AF focusing point selection button and handstrap (optional) optimally positioned for operation when holding the camera vertically.



Speedlite 430EZ

This professional flash unit is designed with advanced features and a powerful guide number of 141-ft/43-meters (at ISO 100). Three types of external battery packs are available for situations requiring extended flash shooting. The 430EZ utilizes A-TTL program control for easy handling of a wide variety of photo situations and fill-in flash. A built-in flash exposure compensation function lets you adjust the flash output independently from the camera for total lighting control. Other features include stroboscopic flash which can fire the flash up to 10 times per second, second curtain sync for a natural flowing effect with slow-shutter flash shots, slow synchronization and bounce flash.



Focusing Screens

Six interchangeable focusing screens are available to suit various applications. Each comes with a special tool for simple installation.

* This camera is originally equipped with the Standard Matte Screen.

(1) Standard Matte Screen (Ed-Ne)



Used for general shooting with all lenses.

(2) Screen with Focusing Sensor Marks (Ed-O)



Used for general shooting with all lenses. Contains marks corresponding to the shape of the focusing sensors.

(3) Matte Screen with Grid (Ed-D)



Used for general shooting with all lenses. Contains grid lines for aiding composition. Useful for copying work using macro lenses.

(4) Matte Screen with Scale (Ed-H)



Used for close-up shooting, enlarging and microphotography. Scales provided at the center and edges are useful for determining composition and magnification. Usable with all lenses.

(5) All Matte Screen (Ed-C)



Used for general shooting with all lenses.

The surface of each focusing screen is processed with an extremely high-precision finish. Do not touch the screen with your fingers. When exchanging screens, use the special tool provided with the screen. For details, read the instructions supplied with the screen.

Cases

Keep the camera in its case to protect it while carrying.

Canon offers two special semi-hard cases designed for use with this camera.

Semi-hard Case L (EH7-L): For camera body and EF 35~80mm f/4.5-5.6U or EF 35~105mm f/4.5-5.6U zoom lens.

Semi-hard Case LL (EH7-LL): For camera body and EF 28~105mm f/3.5-4.5U, EF 28~80mm f/3.5-5.6U or EF 35~135mm f/4-5.6U zoom lens.



Dioptric Adjustment Lenses

Attaching a Dioptric Adjustment Lens E to the viewfinder eyepiece makes viewing and focusing easier without glasses for near- and far-sighted users. The built-in viewfinder eyepiece has a power of -1 diopter, and ten eyesight correction lenses are available for adjustment from +3 to -4 diopters. Choose the one which is closest to your eyeglass prescription. We recommend that you actually try the lens before purchasing to make sure you get the one which is best for your eyesight. A special adapter (sold separately: RUBBER FRAME Ed) is necessary for attachment to this camera.

- The Eye Controlled Focus Function can be used with the naked eye, but not when wearing glasses at the same time as using an eyesight compensation lens.



Eye Cup (Ed-E)

When attached to the camera viewfinder, the Eye Cup Ed-E keeps out sunlight, or strong light from other sources, improving viewfinder visibility and the accuracy of the Eye Controlled Focus Feature.



Remote Switch 60T3

This switch connects to the camera's 3-pin remote control socket and allows you to take pictures by pressing the remote switch instead of the camera's shutter button. This is useful for situations where camera shake is likely to occur, such as during close-up photography or when using a super-telephoto lens. Combine with the Extension Cord 1000T3 (extension length: 10 meters/33 feet, sold separately) for taking pictures at a distance from the camera.

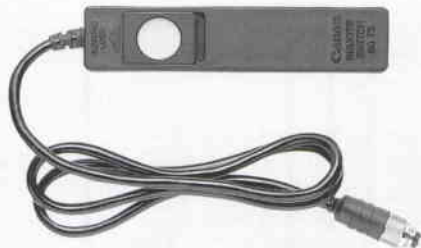

Angle Finder B

The Angle Finder B makes viewing easier for many scientific, copying and close-up photography applications. A special adapter (sold separately: ADAPTER Ed) is necessary for attachment to this camera.

CAMERA CARE

■ Cleaning

Keep your camera in top condition by following these suggestions for periodic cleaning. See the precautions on page 7 for other important information.

1. Cleaning the lens surface—
Blow off dust with a blower brush and gently wipe the lens surface with a piece of lens cleaning paper moistened with lens cleaner. Clean in a **spiral** motion from the center outwards.
 2. Cleaning mirror and focusing screen—
Use a blower brush reserved for this purpose only. If more cleaning is necessary do not attempt to do it yourself. Take the camera to an authorized Canon service facility.
 3. Cleaning the film chamber—
Use a blower brush to remove accumulated film dust particles that might scratch the film. Be careful not to touch the shutter curtain.
 4. Cleaning the film pressure plate and film guide rails
Lightly wipe the surface with a piece of lens cleaning paper moistened with lens cleaning fluid. Be careful not to touch the shutter curtain.
- * Use of aerosol spray dust removers is not recommended.

■ Liquid Crystal Display/Battery Notes

1) LCD Information

The LCD panel uses liquid crystal to show exposure information. After about five years, the display may become difficult to read. If this occurs, have it replaced at an authorized Canon service facility. Replacement is at the owner's expense. Liquid crystal may also respond relatively slowly in temperatures below 32°F/0°C. It may also darken in temperatures of around 140°F/60°C. The LCD panel will return when the temperature returns to normal.

2) Blinking Empty Battery Indicator

There are two situations in which the blinking empty battery indicator will appear in the LCD panel: (1) when the battery is nearly exhausted or (2) when the camera's self-test process detects an internal malfunction. If the blinking empty battery indicator appears, perform the following operations:

1. Remove the battery, wipe the battery terminals and reload it. Check the battery again. If the blinking still appears, replace the battery with a new one.

2. Release the shutter once.
If the battery indicator stops blinking, the problem is corrected and you can continue using the camera normally. If the blinking does not stop, the camera needs to be examined by an authorized Canon service facility.

3) Lithium Battery Information

Always check the battery at the following times:

1. When loading a new battery
2. After lengthy storage
3. If the shutter will not release
4. In cold weather
5. Before an important shooting assignment

Battery Use Information

- Wipe the battery terminals with a clean, dry cloth to ensure proper contact.
- The battery may explode or cause burns if disassembled, recharged, shorted, exposed to high temperatures, or disposed of in fire. Be sure to observe all precautions indicated on the battery package. Always keep it out of the reach of children.

- Battery performance deteriorates slightly in temperatures below 32°F/0°C. Keep the camera and especially a spare battery close to your body or in an inside pocket to keep it warm until use.
- Remove the battery if you do not expect to use the camera for more than three weeks.

4) Camera Operation with a Low Battery

Even if the battery indicator blinks or does not appear in the LCD panel during battery check, exposure will be okay as long as the shutter releases. Film advance and rewind will be impaired by insufficient battery power. If winding or rewinding stops due to the battery, the film cartridge symbol will blink. Film transport resumes after a new battery is loaded and the film rewind button pressed.

Specifications

TYPE AND MAJOR COMPONENTS

Type: 35mm focal plane shutter SLR (single-lens reflex) camera with autofocus, auto exposure, built-in flash and built-in motor drive.

Lens Mount: Canon EF mount (electronic signal transfer system)

Usable Lenses: Canon EF lenses

Viewfinder: Fixed eye-level pentaprism. Gives 92% vertical and 94% horizontal coverage of actual picture area and 0.73x magnification with 50mm lens at infinity.

LCD Pane: Displays necessary information including frame counter, AF mode, film winding mode, metering mode, shutter speed, aperture value, film speed, battery condition and exposure compensation.

Dioptric Adjustment: Built-in eyepiece is adjusted to -1 diopter (eyepoint: 20 mm).

Focusing Screen: Interchangeable, overall matte screen with AF frames.

Shutter: Vertical-travel, focal plane shutter with all speeds electronically controlled.

Shutter Speed: 1/8000 – 30 sec. and bulb.

Maximum X-sync speed: 1/200 sec.

AUTOFOCUS

AF Control System: TTL-SIR (Secondary Image Registration) phase detection type using Cross-type BASIS (Base-Stored Image Sensor).

Two autofocus modes available: One-shot AF and AI Servo AF. Manual focusing also possible.

Focusing Point: Five focusing points provided. Focusing point set automatically by camera, manually by user, or by user eye control.

AF Working Range: EV 0 – 18 at ISO 100.

AF Auxiliary Light: Automatically projected when necessary. Operation linked to focusing points.

EXPOSURE CONTROL

Light Metering: TTL full-aperture metering using a 16-zone SPC (silicon photocell). Three metering modes available: evaluative metering, spot metering (covers approx. 3.5% of the central picture area) and center-weighted average metering.

Metering Range: EV 0 to 20 with 50mm f/1.4 lens at ISO 100 (normal temperature).

Shooting Modes:

1. Program AE
2. Shutter-priority AE
3. Aperture-priority AE
4. Depth-of-field AE
5. Full Auto
6. Programmed Image Control (Portrait, Landscape, Close-up, Sports)
7. Flash AE (A-TTL or TTL program flash AE with built-in flash or dedicated speedlite)
8. X (Flash sync mode)
9. Manual exposure

Camera Shake Warning: Operates in Full Auto and Programmed Image Control modes. Beeper beeps at 2 Hz when automatically-set shutter speed becomes 0 to 0.5 stops slower than "1/focal length of the lens in use."

Multiple Exposures: Up to nine exposures can be preset.

Exposure Compensation: ± 2 stops in 1/2-stop increments.

Auto Exposure Bracketing: ± 2 stops in 1/2-stop increments.

Three continuous exposures are taken in sequence: one at the standard metered value, one under, and one over.

FILM TRANSPORT

Film Speed Setting: Automatically set according to DX code (ISO 25-5000) or set by user (ISO 6-6400).

Film Loading: Automatic. Film automatically advances to first frame when back cover is closed.

Film Wind: Automatic using dedicated miniature motor.

Three modes are available: single exposure, continuous exposure (3 fps maximum) and high-speed continuous exposure (5 fps maximum).

Film Rewind: Automatic rewind at end of roll using dedicated miniature motor.

OTHER

Self-timer: Electronically controlled with 10-second delay.

Custom Function Control: Sixteen built-in custom functions selectable by user.

POWER SOURCE

Battery: One six-volt lithium battery (2CR5).

Battery Check: Battery automatically checked when command dial moved to position other than "L". Battery condition indicator displayed on LCD panel.

SIZE

Dimensions: 154 (W) × 120.5 (H) × 74.2 (D) mm

6-1/16" (W) × 4-3/4" (H) × 2-15/16" (D)

Weight: 665 gr/23.5 oz without battery (body only)

BUILT-IN FLASH

Type: Retractable type TTL automatic zoom flash housed in pentaprism. Bypass control system.

Guide Number (ISO 100, m): 13 (28mm) to 17 (80mm)

Flash Coverage Angle: Automatically zooms to cover the field of view of 28mm, 50mm and 80mm focal lengths.

Recycling Time: Approx. 2 sec.

Flash Control Aperture: Automatically set by TTL program in program modes. Manually set by user in aperture-priority AE, manual exposure and X modes. Automatically set according to ambient light conditions and manually-set shutter speed in shutter-priority AE mode.

X-sync Shutter Speed: Automatically set to 1/60~1/200 sec in program modes according to TTL flash AE program. Automatically set to 30~1/200 sec in aperture-priority AE mode according to ambient light conditions. Manually set to 1/200 sec or slower in shutter-priority AE and manual exposure modes. Manually set to 1/60, 1/90, 1/125 or 1/200 sec in X mode.

Flash Contacts: X-sync contact. Directly coupled contacts provided on accessory shoe.

All data based on Canon's Standard Test Method.
Subject to change without notice.

Attaching the Strap

Thread the strap through the fixtures as shown in the illustration.

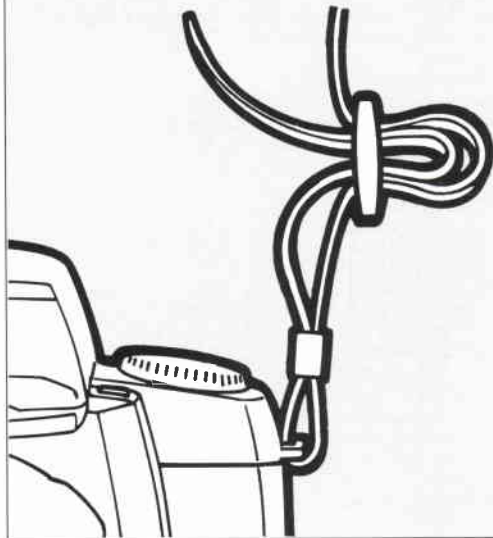

This device complies with Part 15 of the FCC Rules. Operation is subject to the following two conditions: (1) This device may not cause harmful interference, and (2) this device must accept any interference received, including interference that may cause undesired operation.

Do not make any changes or modifications to the equipment unless otherwise specified in the instructions. If such changes or modifications should be made, you could be required to stop operation of the equipment.

This equipment has been tested and found to comply with the limits for a class B digital device, pursuant to part 15 of the FCC Rules. These limits are designed to provide reasonable protection against harmful interference in a residential installation. This equipment generates, uses and can radiate radio frequency energy and, if not installed and used in accordance with the instructions, may cause harmful interference to radio communications.

However, there is no guarantee that interference will not occur in a particular installation. If this equipment does cause harmful interference to radio or television reception, which can be determined by turning the equipment off and on, the user is encouraged to try to correct the interference by one or more of the following measures:

- Reorient or relocate the receiving antenna.
- Increase the separation between the equipment and receiver.
- Consult the dealer or an experienced radio/TV technician for help.

This digital apparatus does not exceed the Class B limits for radio noise emissions from digital apparatus set out in the Radio Interference Regulations of the Canadian Department of Communications.

Free Manuals Download Website

<http://myh66.com>

<http://usermanuals.us>

<http://www.somanuals.com>

<http://www.4manuals.cc>

<http://www.manual-lib.com>

<http://www.404manual.com>

<http://www.luxmanual.com>

<http://aubethermostatmanual.com>

Golf course search by state

<http://golfingnear.com>

Email search by domain

<http://emailbydomain.com>

Auto manuals search

<http://auto.somanuals.com>

TV manuals search

<http://tv.somanuals.com>