

03/18-782

# Canon EF-M



**E**

English Edition

**INSTRUCTIONS**

## **[!] Precautions**

- 1) **This camera is not resistant to water** and should not be used outdoors in snow or rain. If accidentally dropped in water, contact an authorized Canon service facility. Keep the camera out of salt spray, and protect it from excessive humidity. If used at the beach, clean it thoroughly afterward with a dry cloth.
- 2) Do not attempt to disassemble the camera yourself. Always take it to an authorized Canon service facility for repair.
- 3) Remove the battery if you do not expect to use the camera for about three weeks or longer.
- 4) When storing the camera, wrap it in a clean, soft cloth and place in a cool, dry, dust-free place. Be sure to keep the camera out of direct sunlight, and away from "hot spots" such as the trunk or rear window shelf of a car. Avoid places where moth balls are used, and in extreme humidity, use a desiccant.
- 5) Carefully check the camera's operation after lengthy storage.
- 6) The battery may explode or cause burns if disassembled, recharged, shorted, exposed to high temperatures, or disposed of in fire.
- 7) Film passing through X-ray examinations at airports may be exposed and ruined even if loaded in the camera. Request a hand-checked inspection to avoid damage.
- 8) Aerosol spray dust removers are not recommended for the shutter curtain.
- 9) Color reproduction may be adversely affected if the film is left in the camera for a long time. **Always develop exposed film promptly.**

# Nomenclature

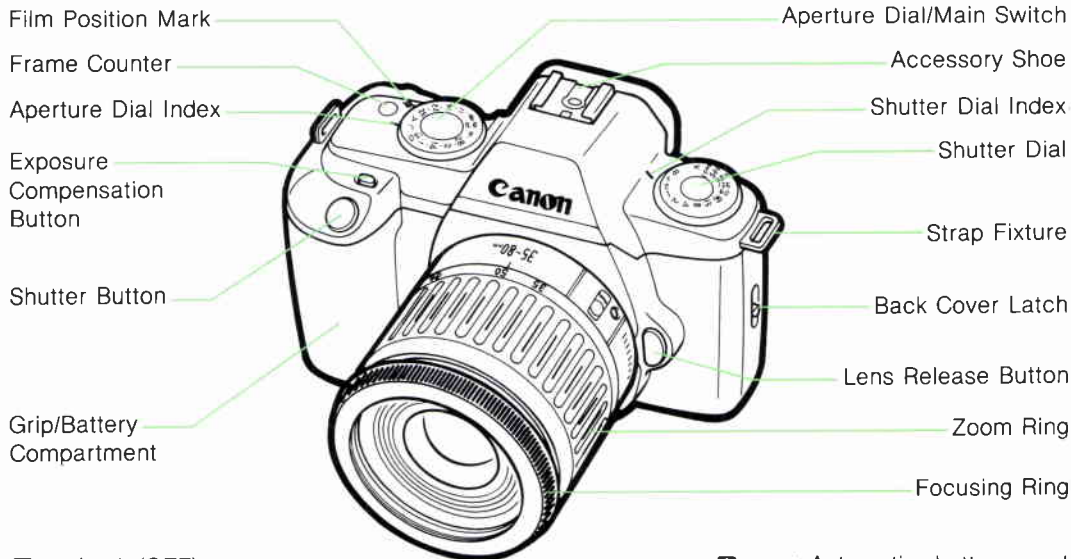

- L** : Lock (OFF)
- A** : Automatic aperture setting
- 1-32: Aperture values (intermediate values can also be set)
- ISO** : Film speed confirmation/Manual film speed setting

**Aperture Dial**



**Shutter Dial**



- A** : Automatic shutter speed setting
- 2-1000: Shutter speeds (2 sec - 1/1000 sec)
- X** : X-sync shutter speed for flash use (1/90 sec)
- B** : Bulb (long exposure)

## Introduction

Thank you for selecting a Canon camera. This camera features large-sized shutter and aperture dials and easy-to-understand exposure control operation. The lightweight, compact body incorporates three automatic exposure modes as well as manual exposure mode, and the full-featured viewfinder display lets you see all necessary camera information without removing your eye from the eyepiece for unsurpassed operational ease even for the first-time SLR user.

The lens mount is the same EF mount provided on EOS cameras, giving you access to the entire line-up of EF interchangeable lenses used by professionals worldwide.

\* The explanations provided in this instruction book assume use of the camera with the EF 35-80mm f/4-5.6 zoom lens attached. However, operation is basically the same for any EF lens.

### Features

1. Easy-to-operate and easy-to-read large-sized shutter and aperture dials.
2. Three automatic exposure modes (Program AE, Shutter-priority AE and Aperture-priority AE) and manual exposure mode.
3. EF mount enables use of a wide array of EF lenses.
4. Prewind type fully-automatic film transport.

## Attention

### IMPORTANT INFORMATION

This Canon camera will give optimum performance together with specially designed Canon EF lenses, flash units and other Canon brand accessories. It is possible that the use of incompatible lenses or other accessories may result in unsatisfactory performance or damage to your camera. We therefore suggest the use of Canon EF lenses and accessories. Damage to your Canon camera as a result of malfunction or improper connections caused by the use of incompatible products may void its warranty.

**Please read these instructions carefully for a thorough understanding before taking pictures.**

While reading this booklet, unfold the front and back flaps for easy reference to the camera's parts.



# Table of Contents

## Preparations

1. Battery Loading and Check	6
2. Lens Attachment	8
3. Viewfinder Information	9
4. Focusing and Composition	10
5. Shutter Button Action	12
6. Film Loading and Removal	13

## Taking Pictures

1. Program AE	16
2. Shutter-priority AE	18
3. Aperture-priority AE	20
4. Manual Exposure	22
5. Self-timer Function	24
6. Flash Photography	25
7. Partial Metering	26
8. Exposure Compensation	28
9. Bulb (Long Exposure) Shooting	29
10. Film Speed Checking and Manual Setting	30
11. Mid-roll Film Rewind Function	31
12. Holding the Camera	32

## Reference

1. Exposure Warnings	33
2. Accessories	34
- Grip Extension GR-70 (sold separately)	34
- Dioptic Adjustment Lenses (sold separately)	34
- Case (sold separately)	34
- Focusing Adapter	35
- Dedicated Speedlite 200M	35

Specifications	36
----------------	----

## Neckstrap Attachment

Thread the ends of the strap through the fixtures as shown.

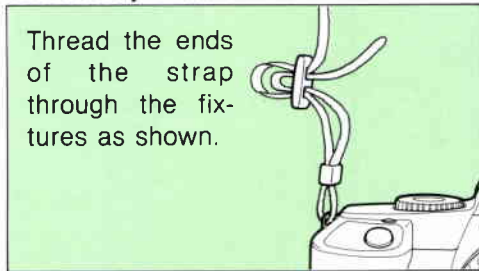

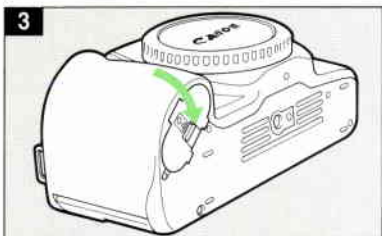
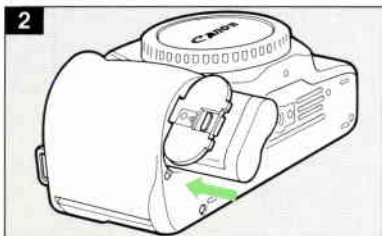
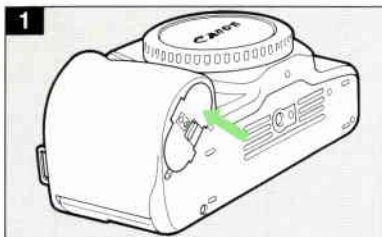

This camera will not operate without a battery.

This camera uses a single lithium battery (2CR5, 6V). Load the battery as follows.

- 1) Slide the battery cover latch to open the battery cover.
- 2) Insert the battery so that its terminals enter the camera first.
- 3) Close the battery cover.

#### ■ Film Shooting Capacity

Temperature	No. of Rolls
Normal (20°C/68°F)	200 rolls
Low (-10°C/14°F)	90 rolls

- \* Using a new battery and 24-exposure film.
- \* Figures include camera operation even when no film is loaded.

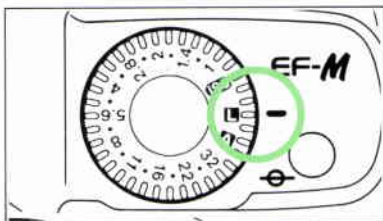
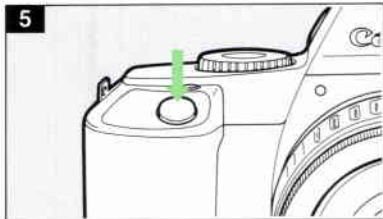
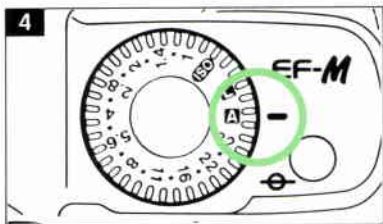

- 4) Set the aperture dial to "A"
- 5) Look through the viewfinder and press the shutter button halfway. If the viewfinder's exposure display lights up, the battery is OK.

- \* If nothing at all appears in the viewfinder display, the battery may be inserted backwards. Reinsert the battery with the terminals facing inward.
- \* If the "⚡" indicator (see page 9) blinks in the viewfinder, replace the battery with a new one.

- When not using the camera, set the aperture dial to "L". This prevents pictures from being taken accidentally and unnecessary battery drain if the shutter button is unintentionally pressed halfway.

## 2. Lens Attachment

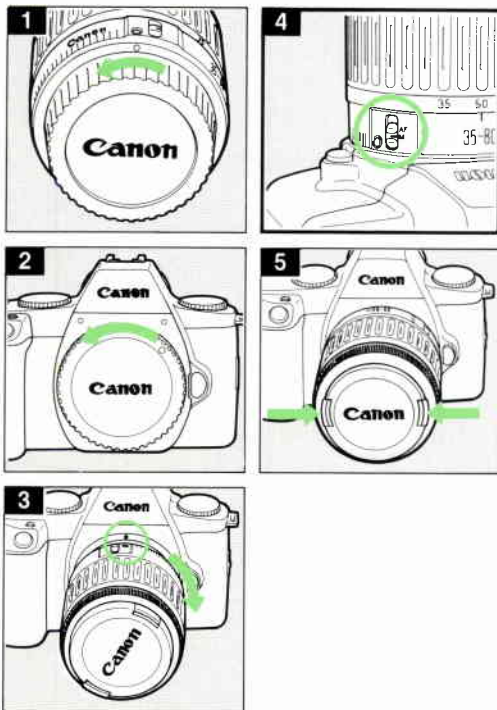

- 1) Remove the rear lens cap by turning counterclockwise.
- 2) Remove the camera body cap by turning counterclockwise.
- 3) Align the red dot on the lens with the red dot on the camera body, then rotate the lens clockwise until it locks in place with a click.
  - \* To remove the lens, press the lens release button while turning the lens counterclockwise.
- 4) Make sure the lens' focus mode switch is set to "M" (manual).
  - \* This camera is a manual focus camera. Do not set the lens to "AF" (autofocus).
- 5) Remove the lens cap.

The lens may already be mounted on the camera when purchased.



### 3. Viewfinder Information

Split-image prism

Partial metering  
area mark

Microprism

Matte screen

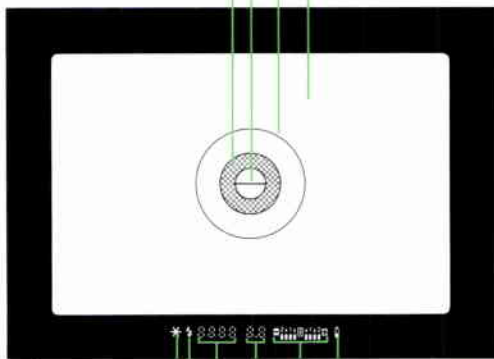

#### \* (Partial metering/AE lock) indicator

This indicator lights when you press the partial metering/AE lock button to lock the exposure reading.

#### ⚡ (Low battery warning) indicator

Blinks when the battery needs to be replaced.

#### Exposure compensation scale

Shows the exposure compensation amount.

In manual exposure mode the “+” and “-” symbols indicate overexposure and underexposure.

#### Aperture value display

Shows the aperture value.

#### Shutter speed/ISO film speed display

Shows the shutter speed.

When the aperture dial is set to “ISO” this display shows the film speed setting.

#### ⚡ (Flash charge completion) indicator

This indicator lights when the dedicated 200M flash unit completes charging and is ready to use.

## 4. Focusing and Composition

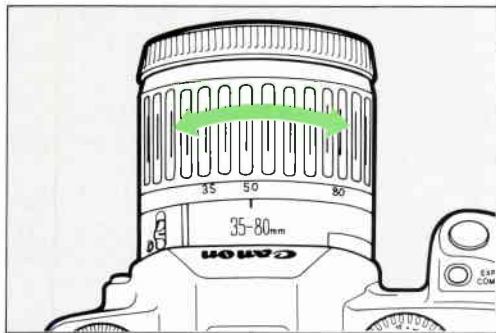

- 1) Look through the viewfinder and turn the zoom ring to set the desired subject size.
  - \* If you are not using a zoom lens, skip this step.
- 2) Look through the viewfinder and turn the lens' manual focusing ring until the subject appears sharp.

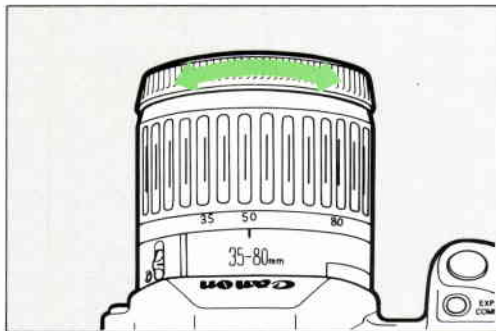

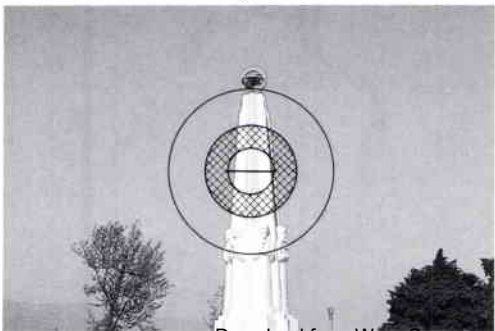
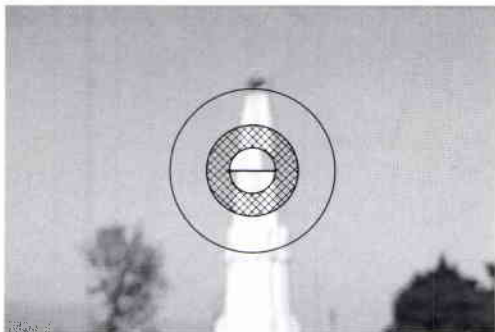

3) Confirm the focus using any of the following three methods.

- ① The subject is focused when the top and bottom images of the split-image prism match.
- ② The subject is focused when the microprism image becomes clear.
- ③ The subject is focused when the image on the matte screen appears sharp.

### **Attaching the Focusing Adapter**

A focusing adapter is available for the EF 35-80mm f/4-5.6 and EF 80-200mm f/4.5-5.6 lenses to make focusing operation easier.

To attach, align the focusing adapter with the filter threads on the front of the lens and turn the adapter clockwise until it stops.

## 5. Shutter Button Action

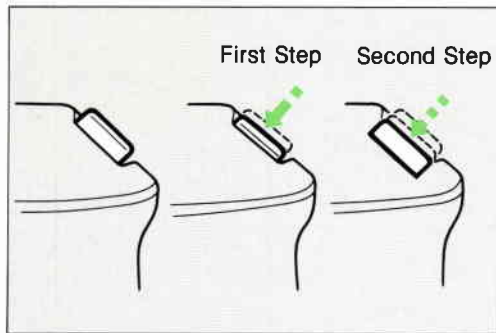

The shutter button has two steps. Pressing the shutter button halfway (to the first step) turns on the viewfinder display. Pressing the shutter button completely takes the picture. Always press the shutter button slowly and gently with the ball of your finger to prevent camera shake.

## 6. Film Loading and Removal

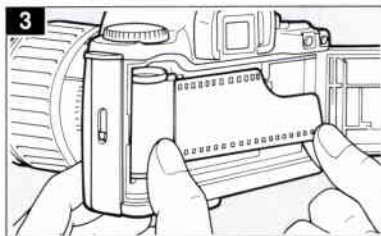
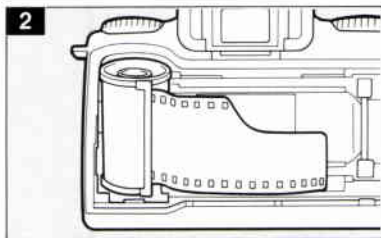
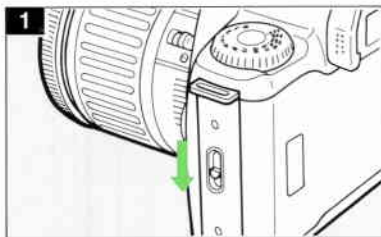

This camera uses a prewind system. When film is loaded, the camera first winds all of the film onto the take-up spool and then rewinds it back into the film cartridge one frame at a time as each picture is taken. The frame counter counts down as pictures are taken, allowing you to always see at a glance how many frames are left. The camera automatically sets the film speed when DX-coded film is loaded.

- 1) Open the back cover by sliding the latch down.
- 2) Insert the film cartridge so that the flat end of the cartridge enters the top of the film chamber.
- 3) While holding down the film cartridge, carefully pull the film tip across until it reaches the orange mark.
  - \* If you pull out too much film, wind the excess slack back into the cartridge.

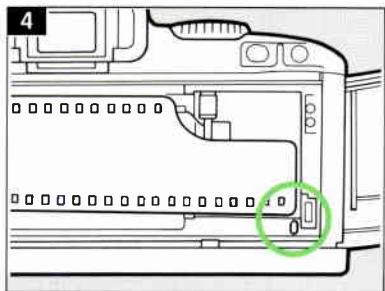

4) After checking that the film lies flat and that the tip is aligned with the orange mark, close the back cover.

The film automatically advances and the frame counter counts up. When the end of film is reached a shutter release sound is heard and the film stops.

\* If a beeper tone sounds for four seconds and the frame counter still shows "E", the film has not been loaded properly and the shutter will not release. Open the back cover and reload the film.

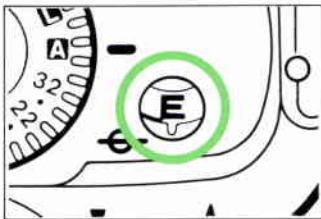

## Film Rewinding

After the last frame is shot the camera automatically rewinds the film into the cartridge. When rewinding is completed, "E" is displayed in the frame counter. After making sure that "E" is displayed, open the back cover and remove the film.

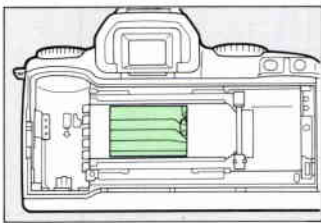

Be careful to never touch the shutter curtain. Its precision design makes it very sensitive to pressure. When loading film, be careful that neither the film tip nor your fingers touch the shutter curtain. Before loading film, set the aperture dial to a position other than "A".

## Taking Pictures 1. Program AE



The camera automatically sets both the aperture and shutter speed according to the brightness values of the main subject and background measured using evaluative metering.

- \* If the main subject is not positioned in the center of the viewfinder frame, we recommend using partial metering with AE lock (see page 26).

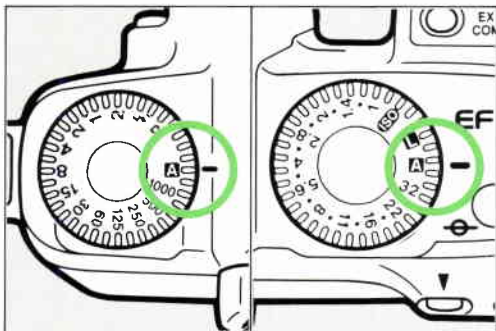

- 1) Set both the shutter dial and aperture dial to "A".
- 2) Look through the viewfinder and focus the subject.



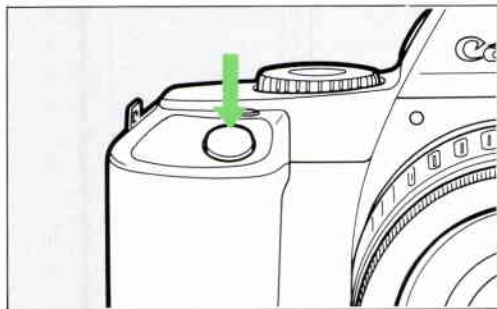

- 3) Press the shutter button halfway and check the viewfinder's exposure display.
- 4) Press the shutter button completely to take the picture.

### Exposure confirmation

If the exposure display blinks, an incorrect exposure will occur. For extremely bright scenes, attach an ND (neutral density) light-reduction filter to the lens. In indoor situations or at night, use a flash.

### Shooting Mode and Metering System Chart

Shooting mode	Metering system		
	Evaluative	Center-weighted average	Partial*
Program AE	●		○
Shutter-priority AE		●	○
Aperture-priority AE		●	○

\* Partial metering is activated by pressing the partial metering button.

### Six-second timer

If you release the shutter button after pressing it halfway, the viewfinder's exposure display will stay lit for approximately six seconds.

## 2. Shutter-priority AE



In this mode you set the shutter speed and the camera automatically sets the aperture value according to the subject brightness measured using center-weighted average metering.

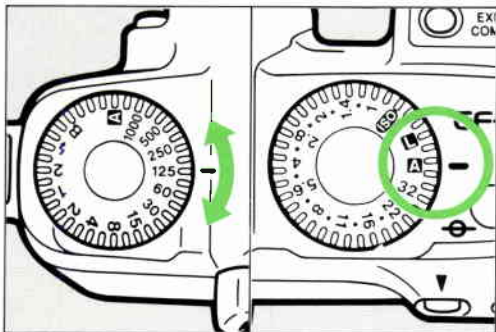

- 1) Set the shutter dial to the desired shutter speed.
- 2) Set the aperture dial to "A".
- 3) Look through the viewfinder and focus the subject.

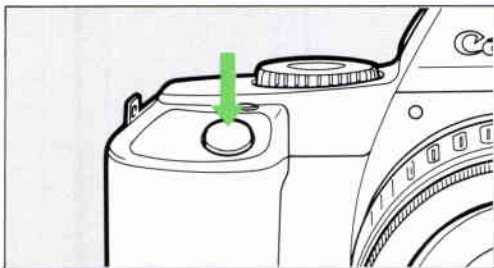

- 4) Press the shutter button halfway and check the viewfinder's exposure display.
- 5) Press the shutter button completely to take the picture.

## Exposure confirmation

- **Overexposure**

The minimum aperture value of the lens blinks in the display. Set the shutter dial to a faster shutter speed until the display stops blinking.

- **Underexposure**

The maximum aperture value of the lens blinks in the display. Set the shutter dial to a slower shutter speed until the display stops blinking.

### 3. Aperture-priority AE



In this mode you set the aperture value and the camera automatically sets the shutter speed according to the subject brightness measured using center-weighted average metering.

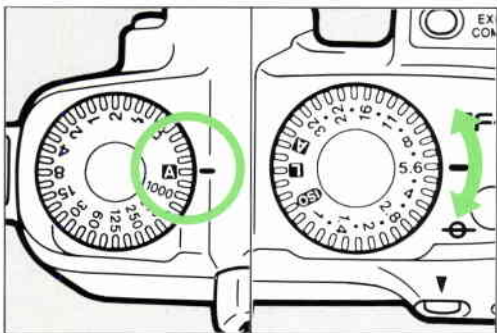

- 1) Set the aperture dial to the desired aperture value.
- 2) Set the shutter dial to "A".
- 3) Look through the viewfinder and focus the subject.



500 5.6

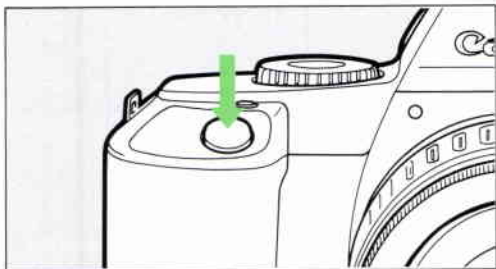

1000 8.0

2" 8.0

- 4) Press the shutter button halfway and check the viewfinder's exposure display.
- 5) Press the shutter button completely to take the picture.

### Exposure confirmation

- **Overexposure**  
1000 blinks in the shutter speed display. Turn the aperture dial until the display stops blinking.
- **Underexposure**  
2" blinks in the shutter speed display. Turn the aperture dial until the display stops blinking.

## 4. Manual Exposure

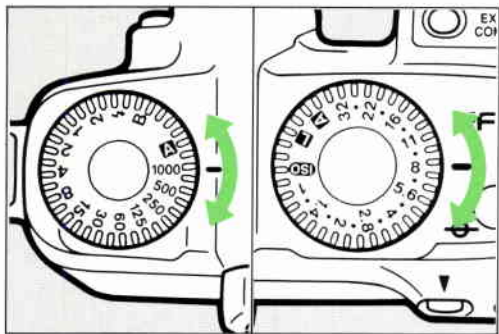

In this mode you set both the shutter speed and the aperture value. Use this mode when using a separate meter or when you wish to purposely vary the exposure.

- 1) Set the shutter dial to the desired shutter speed.
- 2) Set the aperture dial to the desired aperture value.
- 3) Press the shutter button halfway and determine the exposure using the viewfinder's exposure display.



## Exposure level confirmation

- 0 : Correct exposure. Use this position as the reference point for determining the correct exposure.
- 0 + : Overexposure. Change the setting of the aperture dial or shutter dial until the exposure is correct.
- 0 : Underexposure. Change the setting of the aperture dial or shutter dial until the exposure is correct.

## 5. Self-timer Function

Mount the camera on a tripod when using the self-timer.

- 1) After composing the picture and focusing the subject, press the shutter button halfway and confirm the exposure.
  - 2) While looking through the viewfinder, hold the self-timer button pressed and press the shutter button completely. A beeper tone is heard and the picture is taken after a 10-second delay.
- \* To cancel the self-timer in mid-operation, turn the shutter dial or aperture dial to a different position.

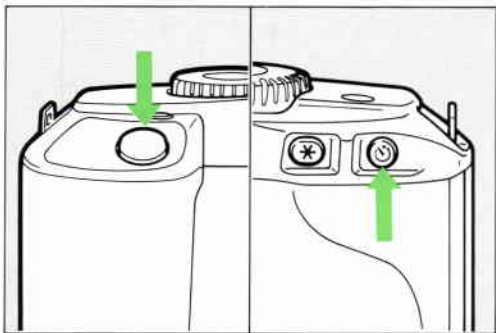



## 6. Flash Photography



Automatic flash photography is possible using the dedicated Speedlite 200M. For details, refer to the "Speedlite 200M" instruction book.

- \* Canon Speedlites other than the dedicated Speedlite 200M cannot be used with this camera.
- \* If using a general-purpose flash, set the shutter dial to  $\frac{1}{90}$  (1/90 sec) or slower. For details on flash operation, refer to the instructions provided with the flash unit.

## 7. Partial Metering

In situations where there is a large difference in brightness between the main subject and background, the subject may not be properly exposed depending on the composition. In such situations use the partial metering button to selectively meter the desired portion of the scene and lock the exposure setting. When partial metering is used the exposure will not change even if the composition is changed.

- 1) Compose the picture and focus the subject.
- 2) While pressing the shutter button halfway, cover the subject with the viewfinder's partial metering mark and press the partial metering button.
  - \* “✱” lights in the viewfinder's information display to indicate that the camera is in partial metering mode. Once “✱” appears you can release the partial metering button. The exposure is locked.





- 3) Recompose the picture keeping the shutter button pressed halfway, then press completely to take the picture.
- \* The exposure does not change as long as you keep the shutter button pressed halfway.

## 8. Exposure Compensation

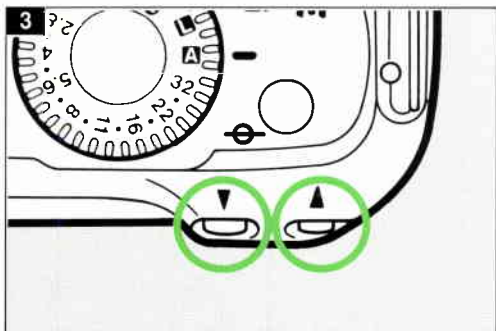
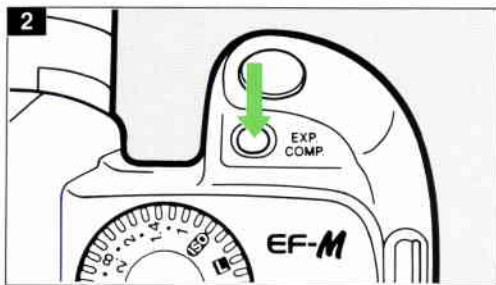

You can compensate the exposure according to the subject conditions when shooting in Program AE, Shutter-priority AE or Aperture-priority AE mode.

Exposure can be compensated up to  $+/-$  2 stops in 1/2-stop increments.

1) Press the shutter button halfway and confirm the exposure in the viewfinder information display.

2) Press the exposure compensation button.

- \* The exposure compensation scale appears in the viewfinder information display.

3) Use the  $\blacktriangledown$ (\*) button or  $\blacktriangle$ (☺) button to set the exposure compensation amount.

- \* To reduce the exposure, press the  $\blacktriangledown$ (\*) button.

- \* To increase the exposure, press the  $\blacktriangle$ (☺) button.

- \* When finished shooting, return the compensation amount to 0.

## 9. Bulb (Long Exposure) Shooting



The shutter stays open for as long as you press the shutter button. Use this mode when long exposures are required such as for night scenes and fireworks displays.

When using bulb mode, mount the camera securely on a tripod to prevent camera movement during exposure.

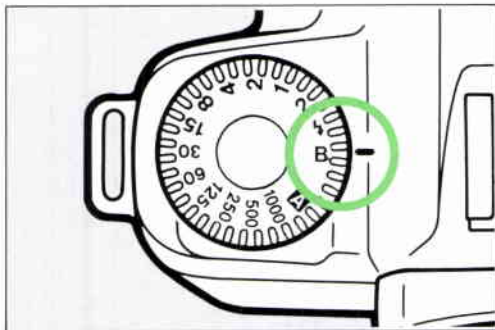

- 1) Set the shutter dial to "B".
- 2) Set the aperture dial to the desired aperture value.
- 3) Look through the viewfinder and focus the subject.
- 4) Press the shutter button for the necessary length of time.
  - \* The viewfinder display turns off during the exposure.

## 10. Film Speed Checking and Manual Setting

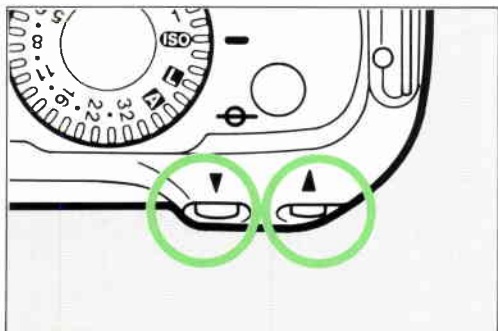
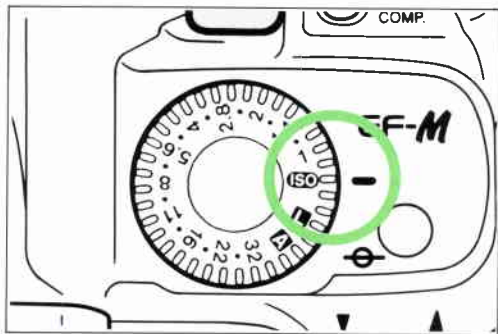

Use this function to check or manually set the film speed. The film speed can be set within a range of ISO 6-6400.

- 1) Set the aperture dial to "ISO".
- 2) Press the shutter button halfway to display the current film speed setting in the viewfinder.
- 3) While watching the viewfinder display, operate the  $\nabla$ (\*) or  $\blacktriangle$ (☺) button to set the desired film speed.
  - \* To set a higher film speed, press the  $\blacktriangle$ (☺) button.
  - \* To set a lower film speed, press the  $\nabla$ (\*) button.

The previously set film speed remains set until you load DX-coded film with a different film speed or manually change the film speed setting.

## 11. Mid-roll Film Rewind Function

This function lets you rewind and remove the film before the roll is finished.

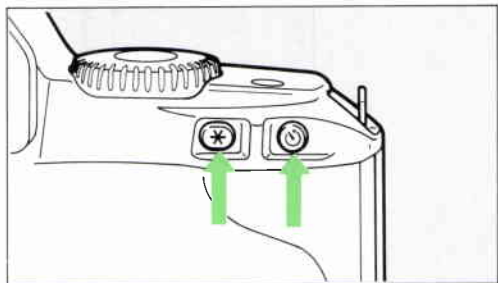
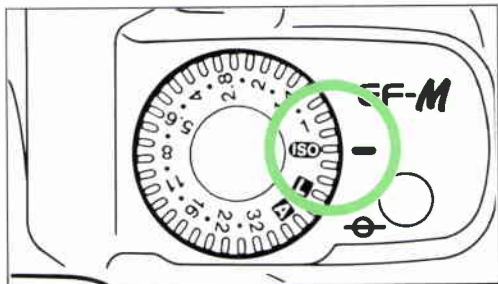

- 1) Remove the lens from the camera.
- 2) Set the aperture dial to "ISO".
- 3) Press the partial metering button and self-timer button simultaneously.
  - \* Film rewinding starts. After the film is rewound completely into the film cartridge a shutter release sound is heard and rewinding stops.
- 4) After confirming that "E" is displayed in the frame counter window, open the back cover and remove the film.

## 12. Holding the Camera



Sharp pictures require that the camera be held still to prevent unnecessary movement called "camera shake." Try the following holding method.

- 1) Hold the camera firmly in your right hand and keep your elbows close to your body.
- 2) Place the palm of your left hand on the bottom of the camera to support the lens.
- 3) Lightly hold the camera against your nose and look into the viewfinder.
- 4) Spread your feet apart about shoulder width with one foot placed slightly forward for a steady, natural stance.



## Reference 1. Exposure Warnings

Shooting mode	Blinking display warning	Meaning	Corrective action
Program AE	Shutter speed 2" and maximum aperture of the lens in use.	Subject is too dark.	Use flash.
	Shutter speed 1000 and minimum aperture of the lens in use.	Subject is too bright.	Use an ND filter.
Shutter-priority AE	Maximum aperture of the lens in use.	Subject will be underexposed.	Turn the shutter dial to a slower shutter speed.
	Minimum aperture of the lens in use.	Subject will be overexposed.	Turn the shutter dial to a faster shutter speed.
Aperture-priority AE	Shutter speed 2" .	Subject will be underexposed.	Turn the aperture dial to open the aperture.
	Shutter speed 1000.	Subject will be overexposed.	Turn the aperture dial to close down the aperture.

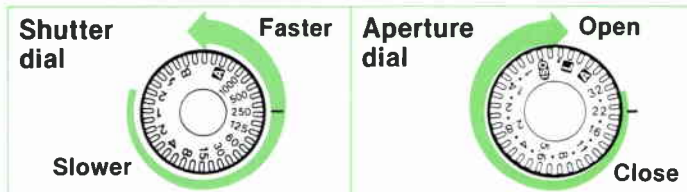

## 2. Accessories



### **Grip Extension GR-70 (sold separately)**

This dedicated grip extension with padded handstrap provides a larger camera grip for improved holding comfort and security.

### **Dioptic Adjustment Lenses (sold separately)**

For eyeglass wearers, there are 10 correction lenses available from +3 to -4. Conduct a test before purchase for the best match to your prescription and make viewing more comfortable.

### **Case (sold separately)**

Keep the camera in its case to protect it while carrying.

Canon offers a special semi-hard case designed for use with this camera.



### **Focusing Adapter**

A focusing adapter is available for the EF 35-80mm f/4-5.6 and EF 80-200mm f/4.5-5.6 lenses to make focusing easier.

### **Dedicated Speedlite 200M**

Use the dedicated Speedlite 200M for easy automatic flash photography.

## Specifications

### TYPE AND MAJOR COMPONENTS

**Type:** 35mm focal plane shutter SLR (single-lens reflex) camera with auto exposure and built-in motor drive.

**Lens Mount:** Canon EF mount (electronic signal transfer system)

**Usable Lenses:** Canon EF lenses

**Standard Lenses:** EF 50mm f/1.8II, EF 35-80mm f/4-5.6

**Viewfinder:** Fixed eye-level pentaprism. Gives 90% vertical and horizontal coverage of actual picture area and 0.75x magnification with 50mm lens at infinity.

**Dioptric Adjustment:** Built-in eyepiece is adjusted to -1 diopter (eyepoint: 20 mm).

**Focusing Screen:** Fixed, overall matte screen with split-image microprism and partial metering mark.

**Shutter:** Vertical-travel, focal plane shutter with all speeds electronically controlled.

**Shutter Speed:** 1/1000 - 2 sec and bulb. X-sync is 1/90 sec.

### EXPOSURE CONTROL

**Metering Systems:** (1) Evaluative metering  
(2) Center-weighted average metering  
(3) Partial metering

**Metering Range:** EV 2-20 with 50 mm f/1.4 lens at ISO 100 (normal temperature).

**Shooting Modes:** (1) Program AE  
(2) Shutter-priority AE  
(3) Aperture-priority AE  
(4) Manual exposure

**Exposure Compensation:** + / - 2 stops in 1/2-stop increments.

### FILM TRANSPORT

**Film Speed Setting:** Automatically set according to DX code (ISO 25-5000) or set by user (ISO 6-6400).

**Film Loading:** Automatic prewind system. After film is positioned and back cover closed, the film automatically winds to the end of the roll and stops.

**Film Winding:** Automatic.

**Film Rewinding:** Automatic.

### POWER SOURCE

**Battery:** One six-volt lithium battery (2CR5).

**Battery Check:** Possible when aperture dial is set to a position other than "L".

## Nomenclature

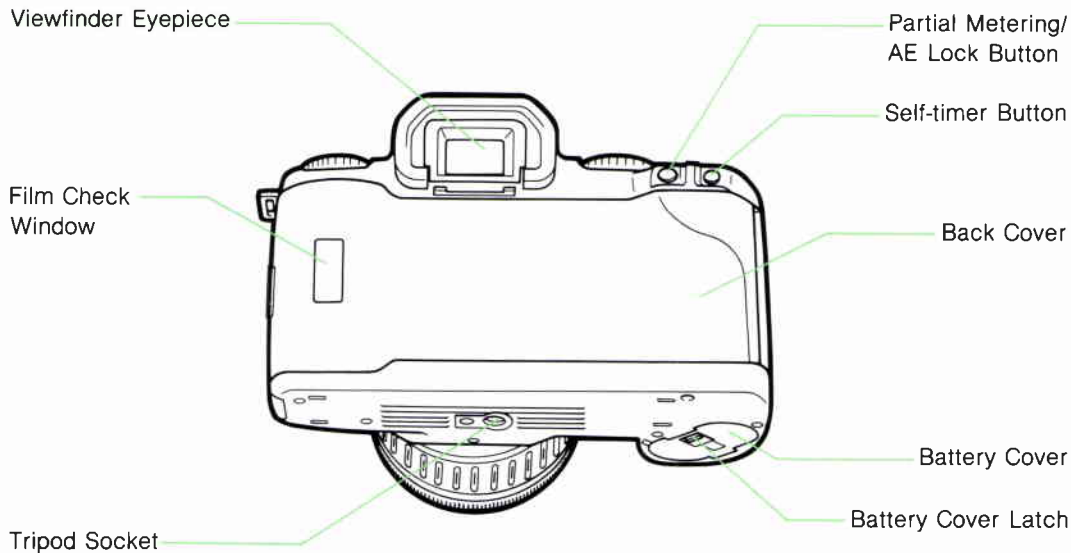

These devices comply with Part 15 of the FCC Rules. Operation is subject to the following two conditions: (1) These devices may not cause harmful interference, and (2) these devices must accept any interference received, including interference that may cause undesired operation.

Do not make any changes or modifications to the equipments unless otherwise specified in the instructions. If such changes or modifications should be made, you could be required to stop operation of the equipments.

These equipments have been tested and found to comply with the limits for a class B digital device, pursuant to part 15 of the FCC Rules. These limits are designed to provide reasonable protection against harmful interference in a residential installation. These equipments generate, use and can radiate radio frequency energy and, if not installed and used in accordance with the instructions, may cause harmful interference to radio communications.

However, there is no guarantee that interference will not occur in a particular installation. If these equipments do cause harmful interference to radio or television reception, which can be determined by turning the equipments off and on, the user is encouraged to try to correct the interference by one or more of the following measures:

- Reorient or relocate the receiving antenna.
- Increase the separation between the equipments and receiver.
- Consult the dealer or an experienced radio/TV technician for help.

These digital apparatuses do not exceed the Class B limits for radio noise emissions from digital apparatuses set out in the Radio Interference Regulations of the Canadian Department of Communications.

## OTHER

**Self-timer:** Electronically controlled with a 10-sec. delay.

**Flash Contacts:** X-sync contact. Directly coupled contacts provided on accessory shoe.

## DIMENSIONS

**Size:** 148 (W) × 96.3 (H) × 68 (D) mm

**Weight:** 390 gr (body only, without battery)

## LENSES

Lenses		EF 50mm f/1.8II	EF 35-80mm f/4-5.6
Field of View	Diagonal	46°	63° - 30°
	Vertical	27°	30° - 17°
	Horizontal	40°	54° - 25°
Lens Construction		6 elements in 5 groups	8 elements in 8 groups
Minimum Aperture		22	22 - 32
Shooting Distance		0.45 m - infinity	0.37 m - infinity
Maximum Magnification		0.15 (160 × 240 mm)	35mm: 0.12 (200 × 300 mm) 80mm: 0.25 (96 × 144 mm)
Filter Size		52 mm	52 mm
Length × Max. Diameter		41 × 68.2 mm	61 × 68.6 mm
Weight		130 gr	190 gr

All data are based on Canon's Standard Test Method.  
Subject to change without notice.

The following EF lenses are for use only with autofocus cameras and thus cannot be used with this camera.

(1) EF 35-70mm f/3.5-4.5A (2) EF 100-200mm f/4.5A (3) Power Zoom EF 35-80mm f/4-5.6 (4) Extension Tube EF25

A lens hood cannot be used when the manual focusing adapter is attached.

# Canon

**CANON INC.** 7-1, Nishi-Shinjuku 2-Chome, Shinjuku-ku, Tokyo 163, Japan  
Mailing address: P.O. Box 5050, Dai-ichi Seimei Building, Tokyo 163, Japan

U.S.A. **CANON U.S.A., INC. HEADQUARTERS**  
One Canon Plaza, Lake Success, N.Y. 11042, U.S.A.  
**CANON U.S.A., INC. NEW JERSEY OFFICE**  
P.O. Box 1000, 100 Jamesburg Road, Jamesburg, New Jersey 08831 U.S.A.  
**CANON U.S.A., INC. WASHINGTON D. C. OFFICE**  
5701 General Washington Drive, Alexandria, Va. 22312, U.S.A.  
**CANON U.S.A., INC. CHICAGO OFFICE**  
100 Park Blvd. Itasca, Il. 60143-2693, U.S.A.  
**CANON U.S.A., INC. ATLANTA OFFICE**  
5625 Oakbrook Parkway, Norcross, Ga. 30093, U.S.A.  
**CANON U.S.A., INC. DALLAS OFFICE**  
3200. Regent Blvd., Irving, Tex. 75063-3145, U.S.A.  
**CANON U.S.A., INC. LOS ANGELES OFFICE**  
15955 Alton Parkway, Irvine, Ca. 92713 U.S.A.  
**CANON U.S.A., INC. SANTA CLARA OFFICE**  
2051 Mission College Blvd. Santa Clara, Ca. 95054-1609, U.S.A.  
**CANON U.S.A., INC. HONOLULU OFFICE**  
1020 Auahi St., Bldg. #8, Honolulu, Hawaii 96814, U.S.A.

CANADA **CANON CANADA INC. HEADQUARTERS**  
6390 Dixie Road, Mississauga, Ontario L5T 1P7, Canada  
**CANON CANADA INC. MONTREAL SERVICE CENTRE**  
10655 Côte de Liesse, Lachine, Québec H6T 1A5, Canada  
**CANON CANADA INC. CALGARY OFFICE**  
2826, 18th Street, N.E. Calgary, Alberta T2E 7K7, Canada

EUROPE, AFRICA  
& MIDDLE EAST **CANON EUROPA N.V.**  
Bovenkerkerweg 59-61, P.O. Box 2262, 1180 EG Amstelveen, The Netherlands  
**CANON PHOTO VIDEO FRANCE S.A.**  
"La Doublon" 11, Avenue DuBoisnet 92407 Courbevoie Cedex, France  
**CANON UK LTD.**  
Units 4 & 5, Brent Trading Centre, North Circular Road, London NW10 0JF, United Kingdom  
**CANON EURO-PHOTO G.m.b.H**  
Siemensring 90-92, D-4158 Willich 1, Germany

CENTRAL &  
SOUTH AMERICA **CANON LATIN AMERICA, INC. DEPTO. DE VENTAS**  
Apartado 7022, Paseo 5, República de Panamá  
**CANON LATIN AMERICA, INC. CENTRO DE SERVICIO Y REPARACION**  
Apartado 2019, Zona Libre de Colón, República de Panamá

SOUTHEAST ASIA **CANON HONGKONG TRADING CO., LTD.**  
10/F., Mirror Tower, 61 Mody Road, Tsimshatsui East, Kowloon, Hong Kong  
**CANON SINGAPORE PTE. LTD.**  
95 South Bridge Road #13-01/15, Pidemco Centre, Singapore 0105

OCEANIA **CANON AUSTRALIA PTY. LTD.**  
1 Thomas Holt Drive, North Ryde, N.S.W. 2113, Australia  
**CANON NEW ZEALAND LTD.**  
Fred Thomas Drive, P.O. Box 33-336, Takapuna, Auckland, New Zealand

JAPAN **CANON SALES CO., INC.**  
12-15, Mitte, 3-Chome, Minato-ku, Tokyo 106, Japan



## Free Manuals Download Website

<http://myh66.com>

<http://usermanuals.us>

<http://www.somanuals.com>

<http://www.4manuals.cc>

<http://www.manual-lib.com>

<http://www.404manual.com>

<http://www.luxmanual.com>

<http://aubethermostatmanual.com>

Golf course search by state

<http://golfingnear.com>

Email search by domain

<http://emailbydomain.com>

Auto manuals search

<http://auto.somanuals.com>

TV manuals search

<http://tv.somanuals.com>