

Canon

EOS 1000



Exif Print

DPOF

PictBridge

HI-SPEED
CERTIFIED
USB

ENGLISH

INSTRUCTION
MANUAL

Download from www.Somanuals.com. All Manuals Search And Download.

Canon

EOS 1000

INSTRUCTION MANUAL

Thank you for purchasing a Canon product.

The EOS 1000D is a digital single-lens reflex camera with a 10.10-megapixel image sensor. The camera provides many features such as high-speed, 7-point autofocus to quickly focus moving subjects, Picture Styles to expand your photographic expression, diverse shooting modes from Full Auto to Creative modes, and Live View shooting.

It also incorporates the EOS Integrated Cleaning System to eliminate dust spots on images and the Self Cleaning Sensor Unit to shake off dust on the sensor.

Take a Few Test Shots to Familiarize Yourself with the Camera

With a digital camera, you can immediately view the image you have captured. While reading this manual, take a few test shots and see how they come out. You can then better understand the camera.

To avoid botched pictures and accidents, read the Safety Warnings (p.186,187) and Handling Precautions (p.12,13).

Test the Camera Before Using and Liability

After shooting, playback and check whether the image has been properly recorded. If the camera or memory card is faulty and the images cannot be recorded or downloaded to the personal computer, Canon cannot be held liable for any loss or inconvenience caused.

Copyrights

Copyright laws in your country may prohibit the use of your recorded images of people and certain subjects for anything but private enjoyment. Also be aware that certain public performances, exhibitions, etc., may prohibit photography even for private enjoyment.



This camera is compatible with SD memory cards and SDHC memory cards. This manual will refer to all these cards as just "card."
*** The camera does not come with a card (for recording images).**
Please purchase it separately.

Item Check List

Before starting, check that all the following items have been included with your camera. If anything is missing, contact your dealer.



Camera
(with eyecup and
body cap)



Battery Pack LP-E5
(with protective cover)



Battery Charger
LC-E5/LC-E5E*



Wide Strap
EW-100DB III



Interface Cable
IFC-200U

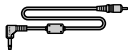

Video Cable
VC-100



EOS DIGITAL
Solution Disk
(Software)



EOS DIGITAL
Software Instruction
Manuals Disk

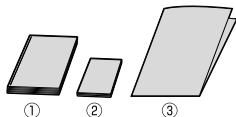









- (1) **Instruction Manual** (this booklet)
- (2) **Pocket Guide**
Quick start guide to shooting.
- (3) **CD-ROM Guide**
Guide to the bundled software (EOS DIGITAL Solution Disk) and EOS DIGITAL Software Instruction Manuals Disk.

* Battery Charger LC-E5 or LC-E5E is provided. (The LC-E5E comes with a power cord.)

- If you purchased the Lens Kit, check that the lens is included.
- Depending on the Lens Kit type, the lens instruction manual might also be included.
- Be careful not to lose any of the above items.

Conventions Used in this Manual

Icons in this Manual

-  : Indicates the Main Dial.
-  <  > : Indicate the <  > cross keys.
-  : Indicates the setting button.
-  4,  6,  16 : Indicates that the respective function remains active for 4 sec., 6 sec., or 16 sec. respectively after you let go of the button.

* In this manual, the icons and markings indicating the camera's buttons, dials, and settings correspond to the icons and markings on the camera and on the LCD monitor.

MENU : Indicates a function which can be changed by pressing the <MENU> button and changing the setting.

★ : When shown on the upper right of the page, it indicates that the function is available only in the Creative Zone modes (p.20).

(p.**): Reference page numbers for more information.

 : Tip or advice for better shooting.

 : Problem-solving advice.

 : Warning to prevent shooting problems.

 : Supplemental information.

Basic Assumptions

- All operations explained in this manual assume that the power switch is already set to <ON>.
- It is assumed that all the menu settings and Custom Functions are set to the default.
- For explanatory purposes, the instructions show the camera attached with an EF-S 18-55mm f/3.5-5.6 IS lens.

Chapters

For first-time users, chapters 1 and 2 explain the camera's basic operations and shooting procedures.

	Introduction Camera basics.	2
1	Getting Started	23
2	Basic Shooting and Image Playback Fully automatic shooting for different subjects.	43
3	Advanced Shooting Techniques Basic shooting features for specific types of subjects.	55
4	More Advanced Techniques Advanced shooting techniques.	69
5	Live View Shooting Shoot while viewing the LCD monitor.	95
6	Handy Features Convenient menu-based functions.	107
7	Image Playback	123
8	Printing Images and Transferring Images to a Computer	133
9	Customizing the Camera	151
10	Reference	161

Contents

Introduction

Item Check List.....	3
Conventions Used in this Manual.....	4
Chapters.....	5
Contents at a Glance.....	10
Handling Precautions.....	12
Quick Start Guide.....	14
Nomenclature.....	16

1 Getting Started 23

Recharging the Battery.....	24
Installing and Removing the Battery.....	26
Turning on the Power.....	27
Setting the Date and Time.....	29
Selecting the Interface Language.....	30
Installing and Removing the Card.....	31
Mounting and Detaching a Lens.....	33
About the Lens Image Stabilizer.....	35
Basic Operation.....	36
Menu Operations and Settings.....	38
Formatting the Card.....	40
Switching the LCD Monitor Screen.....	42

2 Basic Shooting and Image Playback 43

Fully Automatic Shooting.....	44
Full Auto Techniques.....	46
Shooting Portraits.....	47
Shooting Landscapes.....	48
Shooting Close-ups.....	49
Shooting Moving Subjects.....	50
Shooting Portraits at Night.....	51
Disabling Flash.....	52
Using the Self-timer.....	53
Image Playback.....	54

3 Advanced Shooting Techniques 55

Program AE.....	56
Changing the ISO Speed	57
Using the Built-in Flash	58
Changing the AF Mode	60
Selecting the AF Point.....	61
Continuous Shooting.....	63
Setting the Image-recording Quality.....	64
Selecting a Picture Style	67

4 More Advanced Techniques 69

Action Shots.....	70
Changing the Depth of Field	72
Manual Exposure	75
Automatic Depth-of-Field AE.....	76
Changing the Metering Mode.....	77
Setting Exposure Compensation.....	78
Auto Exposure Bracketing.....	80
Customizing the Picture Style	82
Registering the Picture Style.....	85
Setting the Color Space	87
AE Lock.....	88
FE Lock.....	89
Setting the White Balance.....	90
White Balance Correction	92
Preventing Camera Shake	94

5 Live View Shooting 95

Preparing for Live View Shooting.....	96
Focusing Manually	98
Shooting.....	99
Using AF to Focus.....	102

6 Handy Features 107

Handy Features	108
Silencing the Beeper	108
Card Reminder	108
Setting the Image Review Time	108
Setting the Auto Power-off Time.....	109
Setting the LCD Monitor Brightness	109
File Numbering Methods	110
Auto Image Rotation.....	112
Checking Camera Function Settings.....	113
Reverting the Camera to the Default Settings.....	114
Setting the LCD Monitor Off/On	115
Changing the Shooting Settings Screen Color.....	115
Flash Control	116
Automatic Sensor Cleaning.....	118
Appending Dust Delete Data	119
Manual Sensor Cleaning	121

7 Image Playback 123

Searching for Images Quickly.....	124
Magnified View	126
Rotating the Image	126
Auto Playback	127
Viewing the Images on TV.....	128
Protecting Images	129
Erasing Images	130
Shooting Information Display.....	131

8 Printing Images and Transferring Images to a Computer 133

Preparing to Print	134
Printing	136
Digital Print Order Format (DPOF).....	143
Direct Printing with DPOF	146
Transferring Images to a Personal Computer	147

9 Customizing the Camera 151

Setting Custom Functions	152
Custom Function Settings	154
Registering My Menu	160

10 Reference 161

When Autofocus Fails	162
Using a Household Power Outlet	163
Using the Remote Switch.....	164
External Speedlites	166
Menu Settings	168
Function Availability Table	170
Troubleshooting Guide.....	172
Error Codes.....	175
System Map	176
Specifications	178
Index	189



Contents at a Glance

Shooting

- **Shoot automatically** → p.43 - 52 (Basic Zone modes)
- **Shoot continuously** → p.47, 50, 63 (Continuous shooting)
- **Take a picture of myself in a group** → p.53 (Self-timer)
- **Freeze the action**
- **Take a blurred action shot** → p.70 (Tv Shutter-priority AE)
- **Blur the background**
- **Keep the background in sharp focus** → p.72 (Av Aperture-priority AE)
- **Adjust the image brightness (exposure)** → p.78 (Exposure compensation)
- **Shoot under low light** → p.44, 57, 58 (Flash photography)
- **Shoot without flash** → p.52 (Flash Off)
- **Photograph fireworks at night** → p.75 (Bulb exposure)
- **Shoot while viewing the LCD monitor** → p.96 (Live View shooting)

Image Quality

- **Set the image effects to match the subject** → p.67 (Selecting a Picture Style)
- **Make a large size print of the picture** → p.64 (L, L, RAW)
- **Take many pictures** → p.64 (S, S)





Focusing

- **Change the point of focus** → **p.61** (AF point selection)
- **Shoot a moving subject** → **p.50, 60** (AI Servo AF)

Playback

- **View the images with the camera** → **p.54** (Playback)
- **Search for pictures quickly** → **p.124** (Index display)
- **Prevent important images from accidental deletion** → **p.129** (Image protect)
- **Delete unnecessary images** → **p.130** (Delete)
- **View the images on a TV set** → **p.128** (Video OUT)
- **Set the LCD brightness** → **p.109** (LCD brightness)

Printing

- **Print pictures easily** → **p.133** (Direct printing)

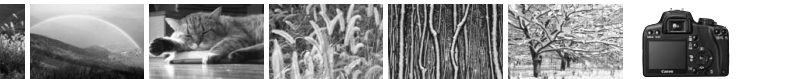

Handling Precautions

Camera Care

- This camera is a precision instrument. Do not drop it or subject it to physical shock.
- The camera is not waterproof and cannot be used underwater. If you accidentally drop the camera into water, promptly consult your nearest Canon Service Center. Wipe off any water droplets with a dry cloth. If the camera has been exposed to salty air, wipe with a well-wrung wet cloth.
- Never leave the camera near anything having a strong magnetic field such as a magnet or electric motor. Also avoid using or leaving the camera near anything emitting strong radio waves such as a large antenna. Strong magnetic fields can cause camera misoperation or destroy image data.
- Do not leave the camera in excessive heat such as in a car in direct sunlight. High temperatures can cause the camera to malfunction.
- The camera contains precision electronic circuitry. Never attempt to disassemble the camera yourself.
- Use a blower to blow away dust on the lens, viewfinder, reflex mirror, and focusing screen. Do not use cleaners that contain organic solvents to clean the camera body or lens. For stubborn dirt, take the camera to the nearest Canon Service Center.
- Do not touch the camera's electrical contacts with your fingers. This is to prevent the contacts from corroding. Corroded contacts can cause camera misoperation.
- If the camera is suddenly brought in from the cold into a warm room, condensation may form on the camera and internal parts. To prevent condensation, first put the camera in a sealed plastic bag and let it adjust to the warmer temperature before taking it out of the bag.
- If condensation forms on the camera, do not use the camera. This is to avoid damaging the camera. If there is condensation, remove the lens, card and battery from the camera, and wait until the condensation has evaporated before using the camera.
- If the camera will not be used for an extended period, remove the battery and store the camera in a cool, dry, well-ventilated location. Even while the camera is in storage, press the shutter button a few times once in a while to check that the camera is still working.
- Avoid storing the camera where there are corrosive chemicals such as a darkroom or chemical lab.
- If the camera has not been used for an extended period, test all its functions before using the camera. If you have not used the camera for some time or if there is an important shoot coming up, have the camera checked by your Canon dealer or check the camera yourself and make sure it is working properly.

LCD Monitor

- Although the LCD monitor is manufactured with very high precision technology with over 99.99% effective pixels, there might be a few dead pixels among the remaining 0.01% or less pixels. Dead pixels displaying only black or red, etc., are not a malfunction. They do not affect the images recorded.
- If the LCD monitor is left on for a prolonged period, screen burn-in may occur where you see remnants of what was displayed. However, this is only temporarily and will disappear when the camera is left unused for a few days.

Cards

- Cards are precision devices. Do not drop the card or subject it to vibration. Doing so could damage the images recorded on them.
- Do not store or use the card near anything having a strong magnetic field such as a TV set, speakers, or magnet. Also avoid places prone to having static electricity. Otherwise, the images recorded on the card might be lost.
- Do not leave the card in direct sunlight or near a heat source. Doing so can warp the cards and make them unusable.
- Do not spill any liquid onto the card.
- Always store your cards in a case to protect the data stored on them.
- Do not bend the card or subject it to any excessive force or physical shock.
- Do not store the card in hot, dusty, or humid locations.

Lens Electrical Contacts

After detaching the lens from the camera, attach the lens caps or put down the lens with the rear end up to avoid scratching the lens surface and electrical contacts.



Cautions During Prolonged Use

When you shoot continuously for a prolonged period or use Live View shooting for a long period, the camera may become hot. Although this is not a malfunction, holding the hot camera for a long period can cause slight skin burns.

Quick Start Guide

1

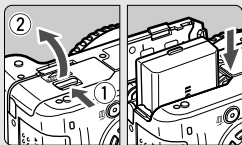

Insert the battery. (p.26)

To recharge the battery, see page 24.

2

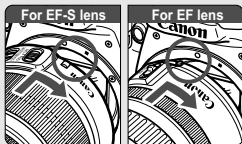

Attach the lens. (p.33)

When attaching an EF-S lens, align it with the white index on the camera.
For other lenses, align it with the red index.

3

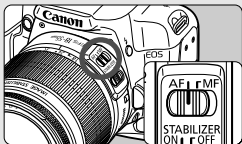

Set the lens focus mode switch to <AF>. (p.33)

4

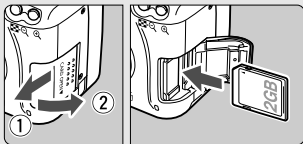

Open the slot cover and insert a card. (p.31)

With the card's label facing you, insert it into the slot.

5

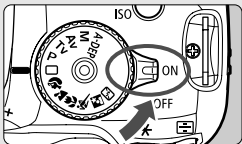

Set the power switch to <ON>. (p.27)

- When the LCD monitor displays the Date/Time setting screen, see page 29.

6

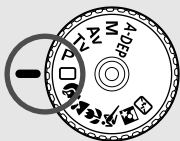

Set the Mode Dial to \square (Full Auto). (p.44)

All the necessary camera settings will be set automatically.

7



Focus the subject. (p.37)

Look through the viewfinder and aim the viewfinder center over the subject. Press the shutter button halfway, and the camera will focus the subject.

8

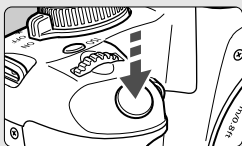

Take the picture. (p.37)

Press the shutter button completely to take the picture.

9



Review the picture. (p.108)

The captured image will be displayed for about 2 sec. on the LCD monitor. To display the image again, press the \blacktriangle button. (p.54)

- The shooting settings displayed on the LCD monitor turns off when you press the shutter button halfway or press the <DISP.> button.
- To delete an image, see “Erasing Images” (p.130).

Nomenclature

The names in bold indicate the parts explained up until the “Basic Shooting and Image Playback” section (up to p.54).

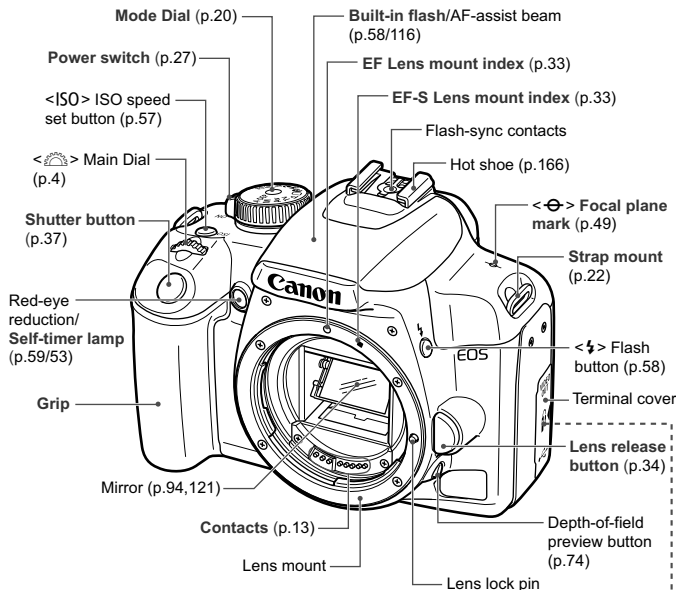

EF-S 18-55mm f/3.5-5.6 IS / II lens

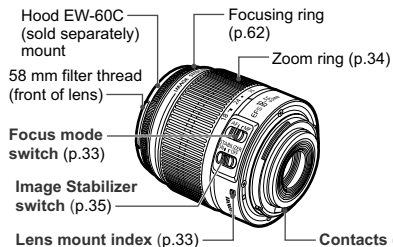

Video OUT terminal (p.128)

Remote control terminal (p.164)

Digital terminal (p.134,147)

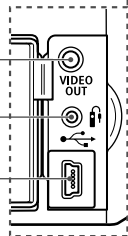

* The EF-S 18-55mm f/3.5-5.6 II lens does not have an Image Stabilizer switch.

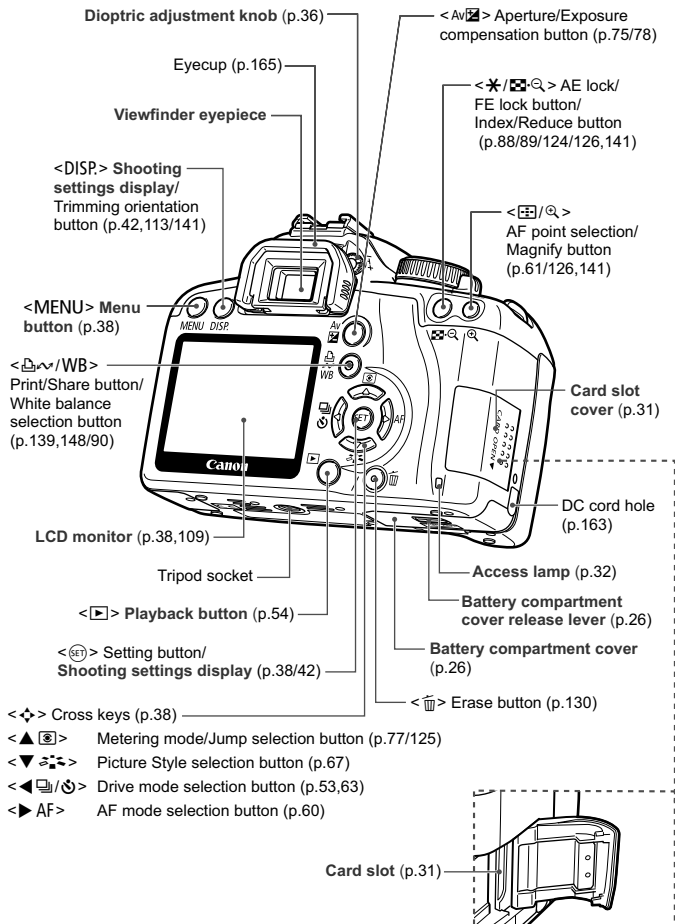

Shooting Settings Display

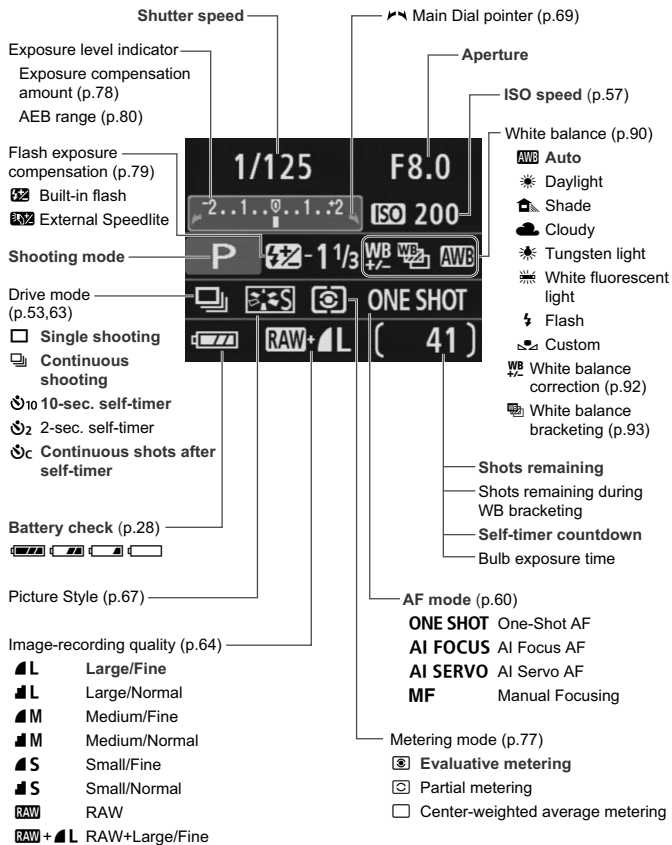

The display will show only the settings currently applicable.

Viewfinder Information

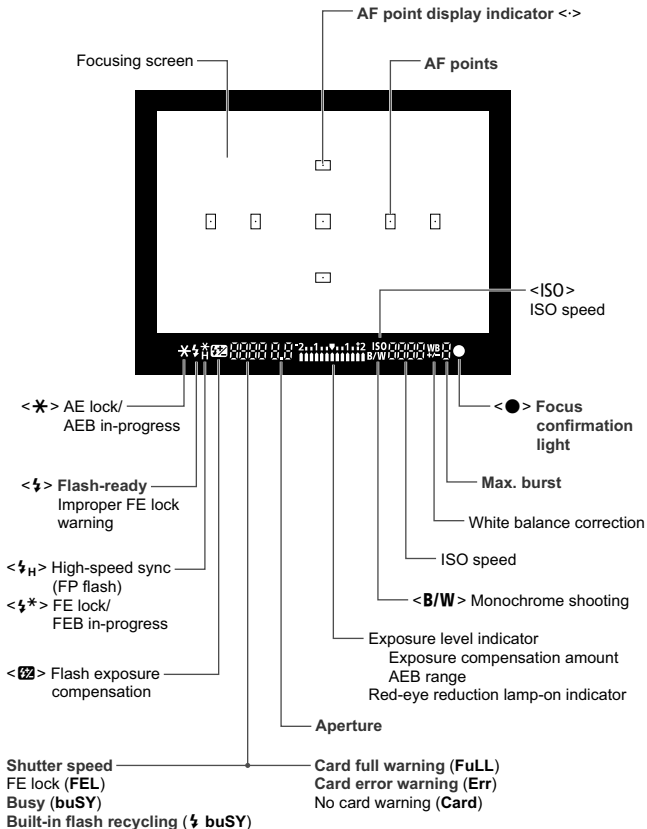

The display will show only the settings currently applicable.

Mode Dial

The Mode Dial has the Basic Zone modes and Creative Zone modes.

Creative Zone

These modes give you more control over the result.

- P** : Program AE (p.56)
- Tv** : Shutter-priority AE (p.70)
- Av** : Aperture-priority AE (p.72)
- M** : Manual exposure (p.75)
- A-DEP** : Automatic depth-of-field AE (p.76)

Full Auto

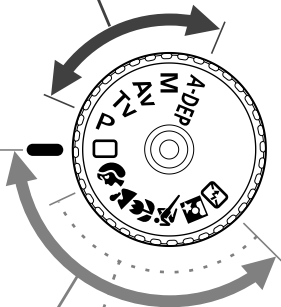





Basic Zone

All you do is press the shutter button. Fully automatic shooting for specific kinds of subjects.

-  : **Full Auto** (p.44)

Image Zone

-  : Portrait (p.47)
-  : Landscape (p.48)
-  : Close-up (p.49)
-  : Sports (p.50)
-  : Night Portrait (p.51)
-  : Flash Off (p.52)

Battery Charger LC-E5

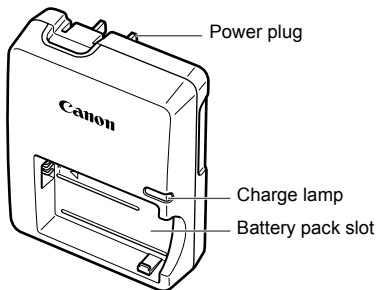

This power unit is intended to be correctly orientated in a vertical or floor mount position.

Battery Charger LC-E5E

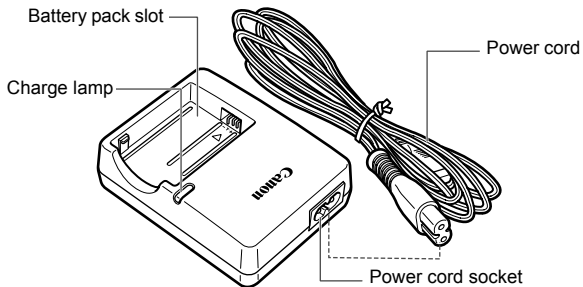

Attaching the Strap

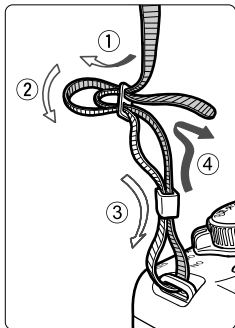

Pass the end of the strap through the camera's strap mount eyelet from the bottom. Then pass it through the strap's buckle as shown in the illustration. Pull the strap to take up any slack and make sure the strap will not loosen from the buckle.

- The eyepiece cover is also attached to the strap. (p.165)

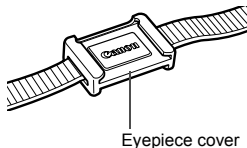

1

Getting Started

This chapter explains preliminary steps and basic camera operations.

Recharging the Battery

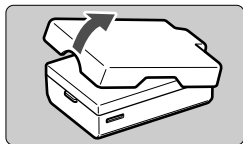

1 Remove the protective cover.

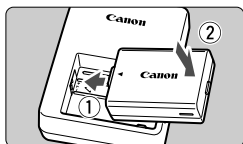

2 Attach the battery.

- As shown in the illustration, attach the battery securely.
- To detach the battery, follow the above procedure in reverse.

LC-E5

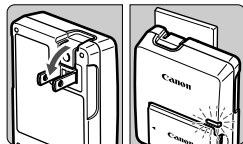

3 Recharge the battery.

For LC-E5

- As shown by the arrow, flip out the battery charger's prongs and insert the prongs into a power outlet.

LC-E5E

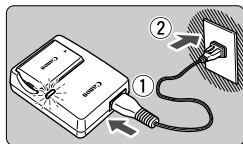

For LC-E5E

- Connect the power cord to the charger and insert the plug into the power outlet.
- ▶ Recharging starts automatically and the charge lamp turns orange.
- ▶ When the battery is fully recharged, the charge lamp will turn green.
- **It takes about 2 hours to fully recharge a completely exhausted battery.**

The time required to recharge the battery depends on the ambient temperature and battery's charge level.



Tips for Using the Battery and Charger

- **Recharge the battery on the day before or on the day it is to be used.**
Even during non-use or storage, a charged battery will gradually discharge and lose its power.
- **After recharging the battery, detach it and unplug the charger from the power outlet.**
- **When not using the camera, remove the battery.**
If the battery is left in the camera for a prolonged period, a small amount of power current is released, resulting in excess discharge and shorter battery life. Store the battery with the protective cover attached. Storing the battery after it is fully charged can lower the battery's performance.
- **The battery charger can also be used in foreign countries.**
The battery charger is compatible with a 100 V AC to 240 V AC 50/60 Hz power source. If necessary, attach a commercially-available plug adapter for the respective country or region. Do not attach any portable voltage transformer to the battery charger. Doing so can damage the battery charger.
- **If the battery becomes exhausted quickly even after being fully charged, the battery has worn out.**
Purchase a new battery.



- Do not charge any battery other than Battery Pack LP-E5.
- Battery Pack LP-E5 is dedicated to Canon products only. Using it with an incompatible battery charger or product may result in malfunction or accidents for which Canon cannot be held liable.

Installing and Removing the Battery

Installing the Battery

Load a fully charged Battery Pack LP-E5 into the camera.

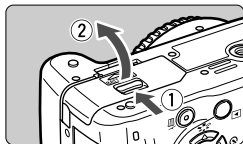

1 Open the battery compartment cover.

- Slide the lever as shown by the arrow and open the cover.

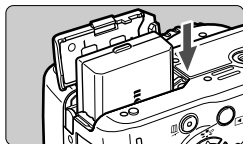

2 Insert the battery.

- Insert the end with the battery contacts.
- Insert the battery until it locks in place.

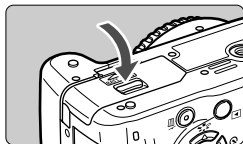

3 Close the cover.

- Press the cover until it snaps shut.

Removing the Battery

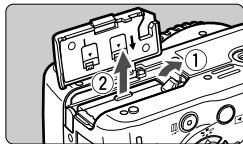

Open the cover and remove the battery.





- Press the battery lock lever as shown by the arrow and remove the battery.
- To prevent shorting, be sure to attach the protective cover to the battery.

ⓘ After opening the battery compartment cover, be careful not to swing it back further. Otherwise, the hinge might break.

Checking the Battery Level

When the power switch is set to <ON>, the battery level will be indicated in one of four levels:



-  : Battery level OK.
-  : Battery level is slightly down, but adequate power remains.
-  : Battery will be exhausted soon.
-  : Battery must be recharged.

Battery Life

[Approx. number of shots]

Temperature	Shooting Conditions	
	No Flash	50% Flash Use
At 23°C / 73°F	600	500
At 0°C / 32°F	500	400

- The figures above are based on a fully-charged LP-E5, no Live View shooting, and CIPA (Camera & Imaging Products Association) testing standards.



- The actual number of shots may be fewer than indicated above depending on the shooting conditions.
- Pressing the shutter button halfway for long periods or operating only the autofocus can also reduce the number of possible shots.
- The number of possible shots will decrease with more frequent use of the LCD monitor.
- The lens operation is powered by the camera's battery. Using certain lenses can reduce the number of possible shots.
- Using the Image Stabilizer of the lens will decrease the number of possible shots (shorter battery life).
- For battery life with Live View shooting, see page 100.

MENU Setting the Date and Time

When you turn on the power for the first time or if the date/time has been reset, the Date/Time setting screen will appear. Follow steps 3 and 4 to set the date/time. **Note that the date/time appended to recorded images will be based on this Date/Time setting. Be sure to set the date/time.**

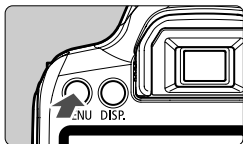

1 Display the menu.

- Press the <MENU> button to display the menu.



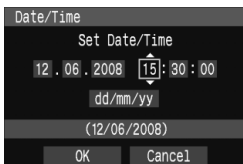

2 Under the [F2] tab, select [Date/Time].

- Press the <◀▶> key to select the [F2] tab.
- Press the <▲▼> key to select [Date/Time], then press <SET>.



3 Set the date and time.

- Press the <◀▶> key to select the date or time number.
- Press <SET> so  is displayed.
- Press the <▲▼> key to set the number, then press <SET>. (returns to )

4 Exit the menu.

- Press the <◀▶> key to select [OK], then press <SET>.
- ▶ The date/time will be set.
- Press the <MENU> button to return to the shooting settings display.



- The date/time set will start from when you press <SET> in step 4.
- If you store the camera without the battery or if the camera's battery becomes exhausted, the date/time might be reset. If this happens, set the date/time again.

MENU Selecting the Interface Language

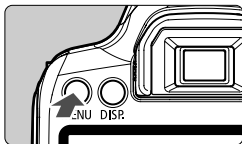

1 Display the menu.

- Press the <MENU> button to display the menu.

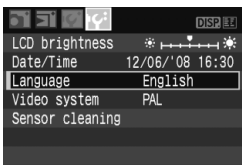

2 Under the [L] tab, select [Language].

- Press the <◀▶> key to select the [L] tab.
- Press the <▲▼> key to select [Language] (the third item from the top), then press <SET>.

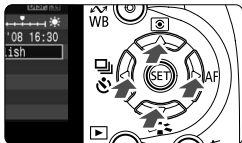

3 Select the desired language.

- Press the <⬆️⬆️⬆️> key to select the desired language, then press <SET>.
- ▶ The menu language will change.
- Press the <MENU> button to return to the shooting settings display.

Language		
English	Italiano	Čeština
Deutsch	Norsk	Magyar
Français	Svenska	简体中文
Nederlands	Español	繁體中文
Dansk	Ελληνικά	한국어
Português	Русский	日本語
Suomi	Polski	

Installing and Removing the Card

The captured image is recorded onto the card (sold separately).

- **Make sure the card's write protect switch is set upward to enable writing/erasing.**

Installing the Card

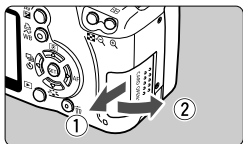

1 Open the cover.

- Slide the cover as shown by the arrow to open it.

Card's write
protect switch

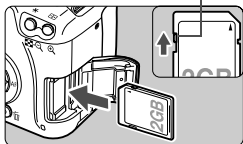

2 Insert the Card.

- As shown by the illustration, face the card's label side toward you and insert it until it clicks in place.

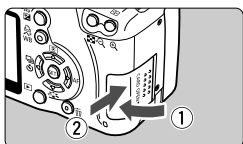

3 Close the cover.

- Close the cover and slide it in the direction shown by the arrow until it snaps shut.
- When you set the power switch to <ON>, the number of remaining shots will be displayed on the LCD monitor.



Shots remaining



- The shots remaining depends on the remaining capacity of the card, image-recording quality, ISO speed, etc.
- The [**⏏** Shoot w/o card] menu option set to [Off] will prevent you from forgetting to install a card. (p.108)

Removing the Card

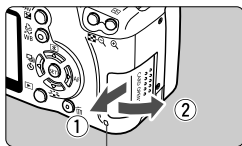

Access lamp

1 Open the cover.

- Set the power switch to <OFF>.
- Check that "Recording..." is not displayed on the LCD monitor.
- **Make sure the access lamp is off, then open the cover.**

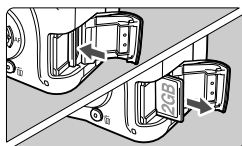

2 Remove the card.

- Gently push in the card, then let go. The card will stick out.
- Pull the card straight out, then close the cover.

- **When the access lamp is lit or blinking, it indicates that the images are being written to or read by the card, being erased, or data is being transferred. While the access lamp is lit or blinking, never do any of the following. Doing so may damage the image data. It may also damage the card or camera.**
 - Opening the card slot cover.
 - Opening the battery compartment cover.
 - Shaking or banging the camera around.
- If the card already contains recorded images, the image number might not start from 0001. (p.110)
- Do not touch the card's contacts with your fingers or metal objects.
- If a card-related error message is displayed on the LCD monitor, remove and reinstall the card. If the error persists, use a different card. If you can transfer all the images in the card to a personal computer, transfer all the images and then format the card (p.40). The card may then return to normal.

Mounting and Detaching a Lens

Mounting a Lens

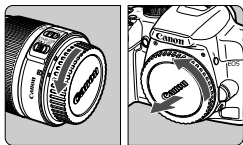

1 Remove the caps.

- Remove the rear lens cap and the body cap by turning them as shown by the arrow.

EF-S lens mount index

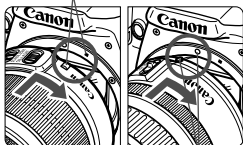

2 Attach the lens.

- Align the EF-S lens with the camera's white EF-S lens mount index and turn the lens as shown by the arrow until it clicks in place.
- When attaching a lens other than an EF-S lens, align the lens with the red EF lens mount index.

EF lens mount index

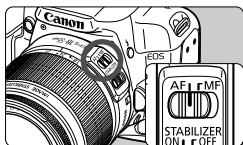

3 On the lens, set the focus mode switch to <AF> (autofocus).

- If it is set to <MF> (manual focus), autofocus will not operate.

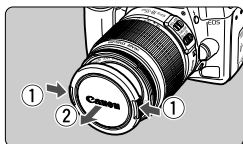

4 Remove the front lens cap.



- Do not look at the sun directly through any lens. Doing so may cause loss of vision.
- If the front part (focusing ring) of the lens rotates during autofocusing, do not touch the rotating part.

About Zooming

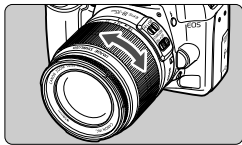

To zoom, turn the zoom ring on the lens with your fingers.

If you want to zoom, do it before focusing. Turning the zoom ring after achieving focus may throw off the focus slightly.

Detaching the Lens

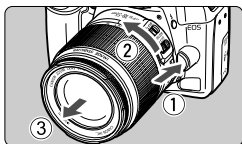

While pressing the lens release button, turn the lens as shown by the arrow.

- Turn the lens until it stops, then detach it.

Minimizing Dust

- When changing lenses, do it in a place with minimal dust.
- When storing the camera without a lens attached, be sure to attach the body cap to the camera.
- Remove dust on the body cap before attaching it.



Image Conversion Factor

Since the image size is smaller than the 35mm film format, it will look like the lens focal length is increased by 1.6x.



Image size
(22.2 x 14.8mm / 0.87 x 0.58 in.)
35mm image size
(36 x 24mm / 1.42 x 0.94 in.)

About the Lens Image Stabilizer

The procedure explained here is based on the EF-S 18-55mm f/3.5-5.6 IS lens as an example.

* IS stands for Image Stabilizer.

* The EF-S 18-55mm f/3.5-5.6 II lens does not have an Image Stabilizer switch.

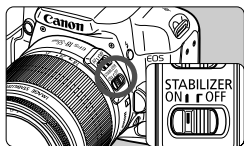

1 Set the IS switch to <ON>.

- Set the camera's power switch to <ON>.

2 Press the shutter button halfway.

- ▶ The Image Stabilizer will operate.

3 Take the picture.

- When the picture looks steady in the viewfinder, press the shutter button completely to take the picture.



- The Image Stabilizer is not effective for moving subjects.
- The Image Stabilizer may not be effective for excessive shaking such as on a rocking boat.



- The Image Stabilizer can operate with the focus mode switch set to either <AF> or <MF>.
- If the camera is mounted on a tripod, you can save battery power by switching the IS switch to <OFF>.
- The Image Stabilizer can operate even when the camera is mounted on a monopod.
- Some IS lenses enable you to switch the IS mode manually to suit the shooting conditions. However, the EF-S 18-55mm f/3.5-5.6 IS lens switches the IS mode automatically.

Basic Operation

Adjusting the Viewfinder Clarity

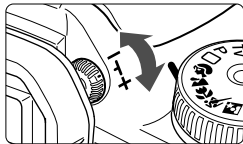

Turn the dioptic adjustment knob.

- Turn the knob left or right so that the seven AF points in the viewfinder look sharp.

If the camera's dioptic adjustment still cannot provide a sharp viewfinder image, using Dioptic Adjustment Lens E (10 types, sold separately) is recommended.

Holding the Camera

To obtain sharp images, hold the camera still to minimize camera shake.

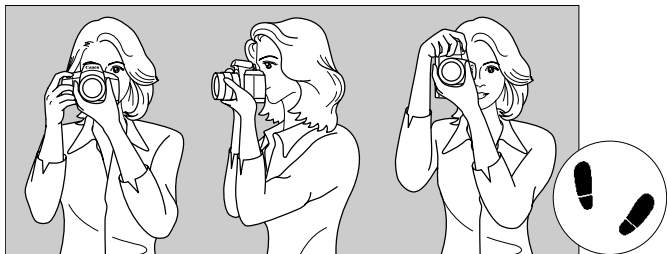

Horizontal shooting

Vertical shooting

1. Wrap your right hand around the camera grip firmly.
2. Hold the lens bottom with your left hand.
3. Press the shutter button lightly with your right hand's index finger.
4. Press your arms and elbows lightly against the front of your body.
5. Press the camera against your face and look through the viewfinder.
6. To maintain a stable stance, place one foot in front of the other.

For shooting while looking at the LCD monitor, see page 95.

Shutter Button

The shutter button has two steps. You can press the shutter button halfway. Then you can further press the shutter button completely.

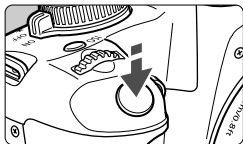

Pressing halfway

This activates autofocus and automatic exposure metering that sets the shutter speed and aperture. The exposure setting (shutter speed and aperture) is displayed in the viewfinder. (ⓘ4)

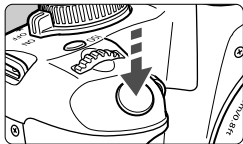

Pressing completely

This releases the shutter and takes the picture.

Preventing Camera Shake

Camera movement during the moment of exposure is called camera shake. Camera shake can cause blurred pictures. To prevent camera shake, note the following:

- Hold and steady the camera as shown on the previous page.
- Press the shutter button halfway to autofocus, then press the shutter button completely.



- If you press the shutter button completely without pressing it halfway first or if you press the shutter button halfway and then press it completely immediately, the camera will take a moment before it takes the picture.
- Even during the menu display, image playback, and image recording, you can instantly go back to shooting-ready by pressing the shutter button halfway.

Menu Operations and Settings

By setting various optional settings with the menus, you can set the image-recording quality, date/time, etc. While looking at the LCD monitor, you use the <MENU> button, <⬆️> cross keys, and <SET> button on the camera back.

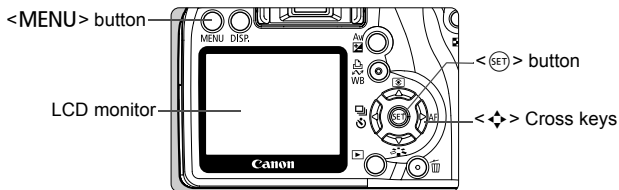

Basic Zone Mode Menu Screen

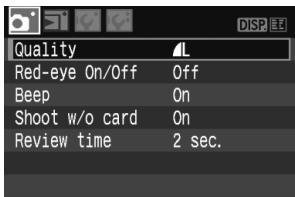
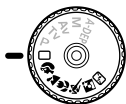

* The [P/Tv/Av/M] tabs are not displayed in the Full Auto and Basic Zone modes. When a Basic Zone mode is set, there are menu items which are not displayed.

Creative Zone Mode Menu Screen

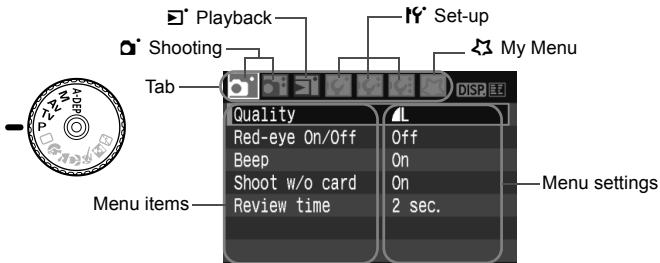

Menu Setting Procedure



1 Display the menu.

- Press the <MENU> button to display the menu.

2 Select a tab.

- Press the <◀▶> key to select a menu tab.
- You can also turn the <☀> dial to select a tab.

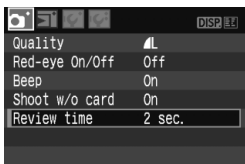

3 Select a menu item.

- Press the <▲▼> key to select the menu item, then press <SET>.

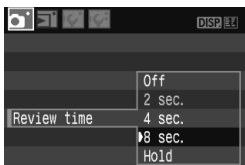

4 Select the setting.

- Press the <▲▼> or <◀▶> key to select the setting. (Some settings require you to press either the <▲▼> or <◀▶> key to select it.)
- Some menu items will indicate the current setting in blue.



5 Set the desired setting.

- Press <SET> to set it.

6 Exit the menu.

- Press the <MENU> button to return to the shooting settings display.



- The explanation of menu functions hereinafter assumes that you have pressed the <MENU> button to display the menu screen.
- A list of menu functions is on page 168.

MENU Formatting the Card

If the card is new or was previously formatted by another camera or personal computer, format the card with the camera.

- 1 **Formatting the card will erase everything in the card. Even protected images will be erased, so make sure there is nothing you need to keep. If necessary, transfer the images to a personal computer before formatting the card.**

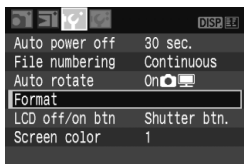

1 Select [Format].

- Under the [DISP] tab, select [Format], then press <SET>.

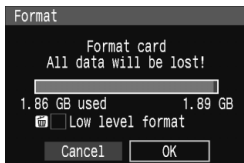

2 Format the card.

- Select [OK], then press <SET>.
- ▶ The card will be formatted.
- ▶ When the formatting is completed, the menu will reappear.
- For low-level formatting, press the <√> button, checkmark [Low level format] with <√>, then select [OK].

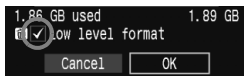

About Low-level Formatting

- Do low-level formatting if the card's recording or reading speed seems slow.
- Since low-level formatting will erase all recordable sectors in the card, the formatting will take slightly longer than normal formatting.
- You can stop the low-level formatting by selecting [**Cancel**]. Even in this case, normal formatting will have been completed and you can use the card as usual.



When the card is formatted, only the file management information is changed. The actual data is not completely erased. Be aware of this when selling or discarding the card. When discarding the card, execute low-level formatting or destroy the card physically to prevent the data from being leaked.



The card's capacity displayed on the format screen may be lower than the capacity indicated on the card.

Switching the LCD Monitor Screen

The LCD monitor can display the shooting settings screen, menu screen, image, etc.

Shooting Settings

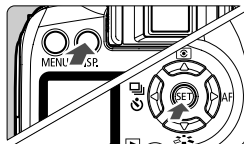

- The shooting settings are displayed when the camera is turned on.
- **The display turns off when you press the shutter button halfway (p.37). When you let go of the shutter button, the display turns on again.**
- **You can also turn off the display by pressing the <DISP.> button or <SET>. Display it again by pressing the button again.**

Menus

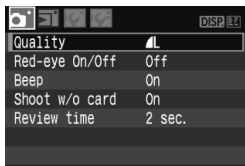

- Appears when you press the <MENU> button. Press the button again to return to the previous screen.

Captured Image



- Appears when you press the <▶> button. Press the button again to return to the previous screen.

- With the [L' LCD off/on btn] menu, you can set the method for turning the shooting settings display on or off. (p.115)
- While the menu or captured image is displayed, you can immediately return to shooting by pressing the shutter button.

2

Basic Shooting and Image Playback

This chapter explains how to use the Basic Zone modes on the Mode Dial for best results and how to playback images.

With the Basic Zone modes, all you do is point and shoot and the camera sets everything automatically. Also, to prevent botched pictures due to mistaken operations, shooting settings cannot be changed in the Basic Zone modes. The settings (functions set automatically) which cannot be set by the user are grayed out.

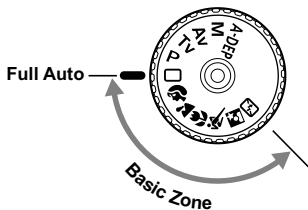

About the Auto Lighting Optimizer

In Basic Zone modes, the Auto Lighting Optimizer will operate to adjust the image automatically to obtain the optimum brightness and contrast. It is also set by default in Creative Zone modes (p.156).

☐ Fully Automatic Shooting

1 Set the Mode Dial to <☐>.

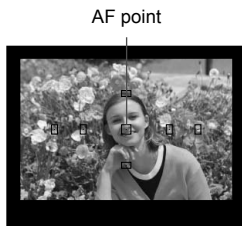

2 Aim any AF point over the subject.

- All the AF points will operate, and focus will generally be achieved at the AF point covering the closest object.
- Aiming the center AF point over the subject will make focusing easier.

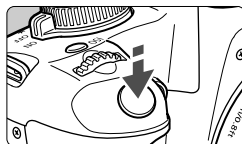

3 Focus the subject.

- Press the shutter button halfway, and the lens will move to focus.
- ▶ The dot inside the AF point achieving focus flashes briefly in red. At the same time, the beeper will sound and the focus confirmation light <●> in the viewfinder will light.
- ▶ If necessary, the built-in flash will pop-up automatically.



4 Take the picture.

- Press the shutter button completely to take the picture.
- ▶ The captured image will be displayed for about 2 sec. on the LCD monitor.
- If the built-in flash has popped up, you can push it back down with your fingers.

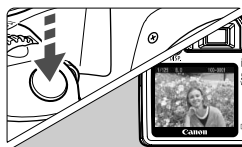

? FAQ

- **The focus confirmation light <●> blinks and focus is not achieved.**
Aim the AF point over an area having good contrast between light and dark, then press the shutter button halfway. (p.162) If you are too close to the subject, move away and try again.
- **Sometimes multiple AF points flash simultaneously.**
This indicates that focus has been achieved at all those AF points. As long as the AF point covering the desired subject flashes, you can take the picture.
- **The beeper continues to beep softly. (The focus confirmation light <●> also does not light.)**
It indicates that the camera is focusing continuously on a moving subject. (The focus confirmation light <●> does not light.) While the beeper is beeping, you can press the shutter button completely to shoot a moving subject in focus.
- **Pressing the shutter button halfway will not focus the subject.**
When the focus mode switch on the lens is set to <MF> (Manual Focus), the camera does not focus. Set the focus mode switch to <AF>.
- **Although it is daylight, the flash popped up.**
For a backlit subject, the flash may pop up to help reduce harsh shadows on the subject.
- **In low light, the built-in flash fired a series of flashes.**
To assist the autofocusing, pressing the shutter button halfway may trigger the built-in flash to fire a series of flashes. This is called AF-assist beam. It is effective up to approx. 4 meters/13.1 feet away.
- **Although flash was used, the picture came out dark.**
The subject was too far away. The subject should be within 5 meters/16.4 feet from the camera.
- **When flash was used, the bottom part of the picture came out unnaturally dark.**
The subject was too close to the camera, and a shadow was created by the lens. The subject should be at least 1 meter/3.3 feet away from the camera. If a hood has been attached to the lens, remove it before taking the flash picture.

Full Auto Techniques

Recomposing the Shot



Depending on the scene, position the subject toward the left or right to create a balanced background and good perspective.



In the (Full Auto) mode, while you press the shutter button halfway to focus a still subject, the focus will be locked. You can then recompose the shot and press the shutter button completely to take the picture. This is called “focus lock”. Focus lock is also possible in other Basic Zone modes (except Sports).

Shooting a Moving Subject



In the (Full Auto) mode, if the subject moves (distance to camera changes) during or after you focus, AI Servo AF will take effect to focus the subject continuously. As long as you keep aiming the AF point on the subject while pressing the shutter button halfway, the focusing will be continuous. When you want to take the picture, press the shutter button completely.

Shooting Portraits

The  (Portrait) mode blurs the background to make the human subject stand out. It also makes flesh tones and the hair look softer than with the  (Full Auto) mode.



Shooting Tips

- **The farther the distance between the subject and background, the better.**



The farther the distance between the subject and background, the more blurred the background will look. The subject will also stand out better in front of a plain, dark background.

- **Use a telephoto lens.**
If you have a zoom lens, use the telephoto end to fill the frame with the subject from the waist up. Move in closer if necessary.
- **Focus the face.**
Check that the AF point covering the face flashes in red.



- If you hold down the shutter button, you can shoot continuously to obtain different poses and facial expressions. (max. approx. 3 shots/sec.)
- If necessary, the built-in flash will pop-up automatically.

Shooting Landscapes

Use the < > (Landscape) mode for wide scenery, night scenes, or to have everything in focus from near to far. The greens and blues also become more vivid and sharp than with < > (Full Auto).



Shooting Tips

- **With a zoom lens, use the wide-angle end.**

When using a zoom lens, use the wide-angle end. This will have objects near and far in focus, better than at the telephoto end. It also adds breadth to landscapes.

- **Shooting night scenes.**

Since the built-in flash will be disabled, this mode is also good for night scenes. Use a tripod to prevent camera shake. If you want to photograph a person against a night scene, set the Mode Dial to < > (Night Portrait) and use a tripod. (p.51)

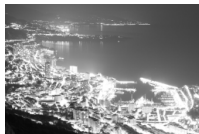



Shooting Close-ups

When you want to photograph flowers or small things up close, use the  (Close-up) mode. To make small things appear much larger, use a macro lens (sold separately).



Shooting Tips

- **Use a simple background.**
A simple background makes the flower, etc., stand out better.
- **Move to the subject as close as possible.**
Check the lens for its minimum focusing distance. Some lenses have indications such as  **0.25m/0.8ft**. The lens minimum focusing distance is measured from the  (focal plane) mark on the camera to the subject. If you are too close to the subject, the focus confirmation light  will blink.
Under low light, the built-in flash will fire. If you are too close to the subject and the bottom of the picture looks dark, move away from the subject.
- **With a zoom lens, use the telephoto end.**
If you have a zoom lens, using the telephoto end will make the subject look larger.

Shooting Moving Subjects

To photograph a moving subject, whether it is a child running or a moving vehicle, use the  (Sports) mode.



Shooting Tips

- **Use a telephoto lens.**

Using a telephoto lens is recommended so you can shoot from afar.

- **Use the center AF point to focus.**

Aim the center AF point over the subject, then press the shutter button halfway to auto focus. During autofocusing, the beeper will continue beeping softly. If focus cannot be achieved, the focus confirmation light  will blink.

When you want to take the picture, press the shutter button completely. If you hold down the shutter button, continuous shooting (max. approx. 3 shots per sec.) and autofocusing will take effect.



 Under low light if camera shake is prone to occur, the viewfinder's shutter speed display on the bottom left will blink. Hold the camera steady and shoot.

Shooting Portraits at Night

To shoot someone at night and obtain a natural-looking exposure in the background, use the  (Night Portrait) mode.



Shooting Tips

- **Use a wide-angle lens and a tripod.**
When using a zoom lens, use the wide-angle end to obtain a wide night view. Use a tripod to prevent camera shake.
- **Keep the person within 5 meters/16.4 feet from the camera.**
Under low light, the built-in flash will fire automatically to obtain a good exposure of the person. The effective distance of the built-in flash is 5 meters/16.4 feet from the camera.
- **Shoot also with  (Full Auto).**
Since camera shake is prone to occur with night shots, shooting also with  (Full Auto) is recommended.



- Tell the subject to keep still even after the flash fires.
- If the self-timer is also used, the self-timer lamp will flash after the picture is taken.

Disabling Flash

In places where flash photography is prohibited, use the <> (Flash Off) mode. This mode is also effective for candlelight scenes when you want to obtain the candlelight effect.

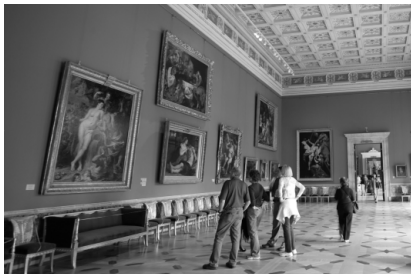

Shooting Tips

- **If the numeric display in the viewfinder blinks, take care to prevent camera shake.**

Under low light when camera shake is prone to occur, the viewfinder's shutter speed display will blink. Hold the camera steady or use a tripod. When using a zoom lens, use the wide-angle end to reduce blur caused by camera shake.

- **Taking portraits without flash.**

Under low light, the person must not move until the picture is taken. If the person moves during the exposure, he or she might look blurred in the picture.

Using the Self-timer

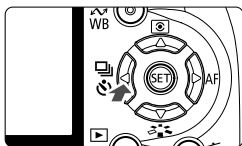

1 Press the <◀▶> button.

2 Select the self-timer.

- Press the <◀▶> key to select the desired self-timer, then press <SET>.

⌚₁₀: 10-sec. self-timer

⌚₂: 2-sec. self-timer* (p.94)

⌚_C: 10-sec. self-timer plus continuous shots



Press the <▲▼> key to set the number of multiple shots (2 to 10) to be taken with the self-timer.

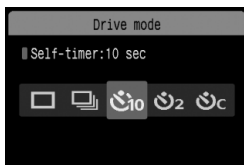

3 Take the picture.

- Focus the subject and press the shutter button completely.
- ▶ You can check the self-timer operation with the self-timer lamp, beeper, and countdown display (in seconds) on the LCD monitor.
- ▶ Two seconds before the picture is taken, the self-timer lamp will stay on and the beeper will sound faster.



With <⌚_C>, the interval between the multiple shots may be prolonged depending on the image-recording quality and flash.



- After taking the self-timer shots, you should check the image(s) for proper focus and exposure (p.54).
- If you will not look through the viewfinder when you press the shutter button, attach the eyepiece cover (p.165). If stray light enters the viewfinder when you press the shutter button, it may throw off the exposure.
- When using the self-timer to shoot only yourself, use focus lock (p.46) for an object at about the same distance as where you will be.
- To cancel the self-timer after it starts, press the <◀▶> button.

▶ Image Playback

The easiest way to playback images is explained below. For more details on image playback methods, see page 123.



1 Playback the image.

- When you press the <▶> button, the last captured image will be displayed.



2 Select the image.

- To view images starting with the last image, press the <◀> key.
To view images starting with the first (oldest) image, press the <▶> key.
- Press the <DISP.> button to change the display format.



Single image display



Single image display + Image-recording quality

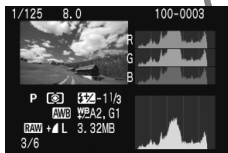

Histogram display



Shooting information display

3 Exit the image playback.

- Press the <▶> button to exit the image playback and return the shooting settings display.

3

Advanced Shooting Techniques

In the Basic Zone modes, to prevent spoiled shots, most functions are set automatically and cannot be changed. In the <P> (Program AE) mode, you can set various functions and be more creative.

- In the <P> (Program AE) mode, the camera sets the shutter speed and aperture automatically to obtain the standard exposure.
- The difference between the Basic Zone modes and <P> is explained on page 170.

* <P> stands for Program.

* AE stands for Auto Exposure.

P: Program AE

To obtain a good exposure of the subject, the camera sets the exposure (shutter speed and aperture) automatically. This is called Program AE.



1 Set the Mode Dial to <P>.



2 Take the picture.

- Press the shutter button halfway and the camera will focus.
- ▶ The exposure setting (shutter speed and aperture) set automatically is displayed in the viewfinder.
- Press the shutter button completely.



Shooting Tips

● Changing the ISO speed and using the built-in flash.

To match the subject and lighting level, you can change the ISO speed (p.57) or use the built-in flash (p.58). In the <P> mode, the built-in flash will not fire automatically. So under low light, press the <⚡> (Flash) button to pop-up the flash.

● The program can be shifted. (Program shift)

After pressing the shutter button halfway, turn the <⚙> dial to change the shutter speed and aperture setting combination (program). After you take the picture, the program shift will be canceled. Program shift is not possible with flash.

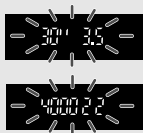

In very low light or very bright light, the shutter speed and aperture display will blink when you press the shutter button halfway, as shown in the figure. In low light (30" 3.5), either increase the ISO speed (p.57) or use flash (p.58). In bright light (4000 22), decrease the ISO speed.

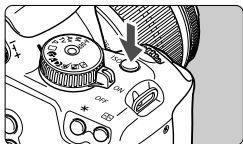

ISO: Changing the ISO Speed [★]

Set the ISO speed (image sensor's sensitivity to light) to suit the ambient light level. In the Basic Zone modes, the ISO speed is set automatically.

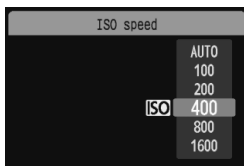

- 1 **Press the <ISO> button.** ()
▶ [ISO speed] will appear.



- 2 **Select the ISO speed.**
 - Turn the <  > dial or press the <  > key to select the ISO speed.
 - You can also look at the ISO speed in the viewfinder while turning the <  > dial.

ISO Speed Guide

ISO Speed	Normal (No flash)	Flash Range
100/200	Sunny outdoors	The higher the ISO speed, the farther the flash range will be. (p.58)
400/800	Overcast skies, evening	
1600	Night or dark indoors	

About Auto ISO

This mode sets the ISO speed automatically between ISO 100 - 800 to suit the shooting mode and ambient light level. For flash and <M> (manual) exposures, ISO 400 is set. When you press the shutter button halfway, the automatically-set ISO speed is displayed in the viewfinder and on the LCD monitor.

 Using a high ISO speed or shooting in high-temperature conditions may result in more grainy images. Long exposures can also cause irregular colors in the image.

⚡ Using the Built-in Flash

In indoors, low light, or backlit conditions, just pop-up the built-in flash and press the shutter button to take flash pictures. In the <P> mode, the shutter speed (1/60 sec. - 1/200 sec.) will be set automatically to prevent camera shake.

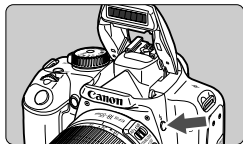

1 Press the <⚡> button.

- In Creative Zone modes, you can press the <⚡> button anytime to take flash pictures.
- While the flash is recycling, “⚡buSY” is displayed in the viewfinder, and [BUSY⚡] is displayed on the LCD monitor.

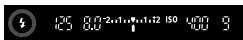

2 Press the shutter button halfway.

- In the bottom left of the viewfinder, check that the <⚡> icon is lit.

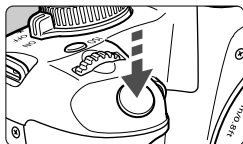

3 Take the picture.

- When focus is achieved and you press the shutter button completely, the flash will fire for the picture.

Effective Flash Range

[Approx. in meters / feet]

ISO Speed	EF-S 18-55mm f/3.5-5.6 IS / II	
	Wide Angle: 18mm	Telephoto: 55mm
100	1 - 3.7 / 3.3 - 12.1	1 - 2.3 / 3.3 - 7.5
200	1 - 5.3 / 3.3 - 17.4	1 - 3.3 / 3.3 - 10.8
400/Auto	1 - 7.4 / 3.3 - 24.3	1 - 4.6 / 3.3 - 15.1
800	1 - 10.5 / 3.3 - 34.4	1 - 6.6 / 3.3 - 21.7
1600	1 - 14.9 / 3.3 - 48.9	1 - 9.3 / 3.3 - 30.5



Shooting Tips

- **If the subject is far away, increase the ISO speed.**
By increasing the ISO speed, you can extend the flash range.
- **In bright light, decrease the ISO speed.**
If the exposure setting in the viewfinder blinks, decrease the ISO speed.
- **Detach the lens hood and keep at least 1 meter/3.3 feet away from the subject.**
If the lens hood is attached or if you are too close to the subject, the bottom portion of the picture might turn out dark. For important shots, check the image on the LCD monitor to make sure the flash exposure looks good (not dark at the bottom).

MENU Using Red-eye Reduction

Using the red-eye reduction lamp before taking a flash picture can reduce red eye. Red-eye reduction will work in any shooting mode except .



- Under the [] tab, select [**Red-eye On/Off**], then press . Select [**On**], then press .
- For flash photography, when you press the shutter button halfway, the red-eye reduction lamp will light. Then when you press the shutter button completely, the picture will be taken.



- The red-eye reduction feature is most effective when the subject looks at the red-eye reduction lamp, when the room is well lit, or when you go closer to the subject.
- When you press the shutter button halfway, the viewfinder display on the bottom will gradually turn off. For best results, take the picture after this display turns off.
- The effectiveness of red-eye reduction varies from subject to subject.

AF: Changing the AF Mode★

You can change the AF mode to suit different subjects such as group photos, animals, and sports.

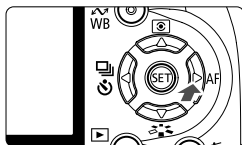

1 Press the <▶> AF> button.

- ▶ [AF mode] will appear.

2 Select the AF mode.

- Press the <◀▶> key to select the AF mode, then press <Ⓢ>.

3 Focus the subject.

- Aim the AF point over the subject and press the shutter button halfway. The camera will then autofocus in the selected AF mode.

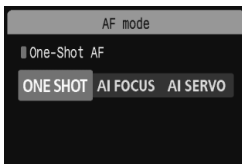

Selecting the Best AF Mode

● ONE SHOT (One-Shot AF)

Suitable for still subjects. When you press the shutter button halfway, the camera will focus only once. You can also recompose the shot.

● AI FOCUS (AI Focus AF)

Suitable when you cannot decide between One-Shot AF or AI Servo AF. Depending on the subject's movement, the camera will switch automatically to One-Shot AF or AI Servo AF.

* When focus is achieved in the AI SERVO AF mode, the beeper will sound softly. The focus confirmation light <●> in the viewfinder will not light.

* AI stands for Artificial Intelligence.

● AI SERVO (AI Servo AF)

Suitable for moving subjects. While you hold down the shutter button halfway, the focus and exposure setting will be adjusted continuously.

* Even when focus is achieved, the beeper will not sound. Also, the focus confirmation light <●> in the viewfinder will not light.

Selecting the AF Point ★

In the Basic Zone modes, all the AF points are active. Generally, the AF point covering the closest subject will be selected to focus. Therefore, the camera sometimes may not focus the subject you want.

With the <P> (Program AE), <Tv>, <Av>, and <M> modes, you can select one AF point to focus where you want.

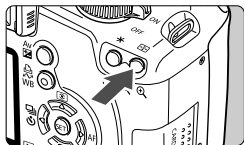

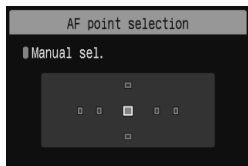

1 Press the < > button. (6)

- ▶ The selected AF point is indicated on the LCD monitor and in the viewfinder.
- When all AF points light up, automatic AF point selection will be set.



2 Select the AF point.

- Press the < > key to select the AF point.
- While looking at the viewfinder, you can select the AF point by turning the < > dial until the desired AF point flashes in red.
- Pressing < > toggles the AF point selection between the center AF point and automatic AF point selection.

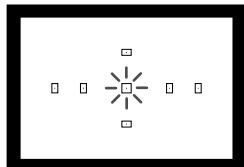

3 Focus the subject.

- Aim the selected AF point over the subject and press the shutter button halfway to focus.



Shooting Tips

- **When shooting a portrait up close, use One-Shot AF and focus the eyes.**

If you focus the eyes first, you can then recompose and the face will remain sharp.

- **If it is difficult to focus, select and use the center AF point.**

The center AF point focuses the best among the seven AF points.

- **To make it easier to focus a moving subject, set the camera to automatic AF point selection and AI Servo AF.**

First use the center AF point to focus. If the subject moves away from the center AF point, the other AF points will continue to focus-track the subject automatically.

Manual Focusing

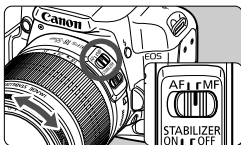

Focusing ring

- 1 **Set the lens focus mode switch to <MF>.**

- 2 **Focus the subject.**

- Focus by turning the lens focusing ring until the subject looks sharp in the viewfinder.



- If you press the shutter button halfway during manual focusing, the AF point achieving focus flashes briefly and the focus confirmation light <●> in the viewfinder will light.
- <AF> stands for Auto Focus. <MF> stands for Manual Focus.



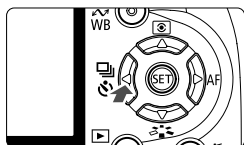

Continuous Shooting ★

You can shoot up to about 3 shots per sec. This is effective for shooting your child running toward you and capturing the different facial expressions.



1 Press the <<   >> button.

2 Select <  >.

- Press the <   > key to select <  >, then press <  >.
- The continuous shooting speed will vary depending on the image-recording quality that has been set (p.64).

JPEG : Max. approx. 3 shots/sec.

RAW : Max. approx. 1.5 shots/sec.

RAW +  : Max. approx. 1.5 shots/sec.

3 Take the picture.

- The camera shoots continuously while you hold down the shutter button fully.



Shooting Tips

- Also set the AF mode matching the subject.

For moving subject

When AI Servo AF is set, focusing will be continuous during continuous shooting.

For still subjects

When One-Shot AF is set, the camera will focus only once during continuous shooting.

- Flash can also be used.

Since the flash will require recharging time, the continuous shooting speed will be slower.



- If the [If: Custom Functions (C.Fn)] menu's [High ISO speed noise reduction] (p.155) is set to [1: On], continuous shooting will not be possible.
- In the AI Servo AF mode, the continuous shooting speed may become slightly slower depending on the subject and the lens used.

MENU Setting the Image-recording Quality

You can select the pixel count (approx. 10.1, 5.3, or 2.5 megapixels) and the image quality.

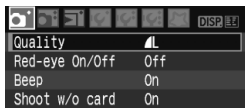

1 Select [Quality].

- Under the [Q] tab, select [Quality], then press <SET>.
- ▶ [Quality] will appear.

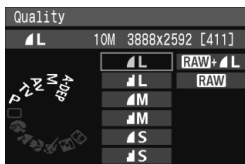

2 Select the image-recording quality.

- For your reference, the respective quality's megapixel count (**M), image size in pixels (**x**), and the number of possible shots [**] will be displayed. Select the desired quality, then press <SET>.
- In the Basic Zone modes, **RAW** and **RAW + L** will not be displayed as an option.
- A different image-recording quality can be set separately for the Basic Zone modes and Creative Zone modes.

Guide to Image-recording Quality Settings

Quality		Pixels	File Size (Approx. MB)	Possible Shots	Maximum Burst
L	High quality	Approx. 10.1 megapixels (10M)	3.8	514	514
L			2.0	982	982
M	Medium quality	Approx. 5.3 megapixels (5.3M)	2.3	859	859
M			1.2	1630	1630
S	Low quality	Approx. 2.5 megapixels (2.5M)	1.3	1474	1474
S			0.7	2816	2816
RAW	High quality	Approx. 10.1 megapixels (10M)	9.8	199	5
RAW + L			9.8+3.8	143	4

* Based on Canon's testing standards with a 2GB card, ISO 100, and Standard Picture Style.

* The file size, number of possible shots, and maximum burst will vary depending on the subject, card brand, ISO speed, Custom Functions, and other settings.

* Depending on the image-recording quality (p.63), the continuous shooting speed will vary.

FAQ

- I want to select the quality matching the paper size for printing.

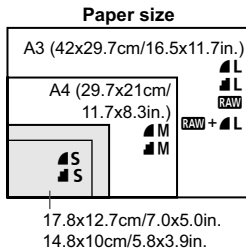

Refer to the diagram on the left when choosing the image-recording quality. If you want to crop the image, selecting a higher quality (more pixels) such as **L**, **L**, **L**, **RAW**, or **RAW + L** is recommended.

- What's the difference between **L** and **L**?**
 It indicates a different image quality due to a different compression rate. Even with the same number of pixels, the **L** image has higher image quality. If **L** is selected, the image quality will be slightly lower, but more images can be saved to the card.
- I took more shots than the number of possible shots indicated.**
 Depending on the shooting conditions, you may be able to take more shots than was indicated. Or, you might be able to take fewer shots than indicated. The possible shots displayed is only an estimate.
- Does the camera display the maximum burst?**
 The maximum burst is displayed in the viewfinder's right side. Since it is only a single-digit indicator 0 - 9, any number higher than 9 will be displayed only as "9." Note that this number will also be displayed even when no card is installed in the camera. Be careful not to shoot without a card in the camera.
- When do I use the **RAW** mode?**
RAW images require processing with your personal computer. For details, see "About **RAW**" and "About **RAW + L**" on the next page. Other than **RAW**, the images will be in the JPEG type commonly used by digital cameras.

About RAW

RAW is the raw data before it is made into a **L** or other images. Although **RAW** images require software like Digital Photo Professional (provided) so they can be displayed on the computer, they also offer flexibility for image adjustments possible only with **RAW**. **RAW** is effective when you want to precisely create your own art or shoot an important subject.

For example, with a **RAW** image, you can use the provided software to create various versions of the same image having a different Picture Style. Also, if you took the picture with the wrong white balance (p.90), you can change the white balance without degrading the image quality. Note that **RAW** images will not work with direct printing or print ordering (DPOF).

About RAW + L

RAW + L records both a **RAW** and **L** image with a single shot. The two images are saved to the card. Since the **L** image is recorded as a processed image, you can view it as is on a personal computer without the bundled software or print it as is. With **RAW + L**, the two images are saved with the same file number in the same folder. You can distinguish between them with the image type or extension. The **RAW** image's extension is "CR2," and the **L** image's extension is "JPG."

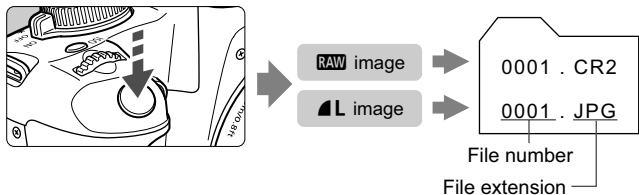

L The Auto Lighting Optimizer (p.156) will not work with **RAW** and **RAW + L** images.

Selecting a Picture Style ★

By selecting a Picture Style, you can obtain the desired image effects matching your photographic expression or the subject.

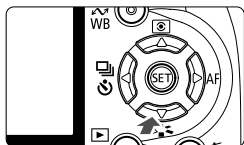

1 Press the <▼ > button.

- ▶ [Picture Style] will appear.

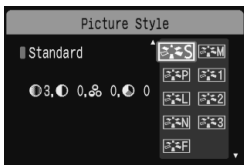

2 Select a Picture Style.

- Press the <▲▼> key to select the Picture Style, then press <SET>.

3 Take the picture.

- Focus and press the shutter button completely. The picture will be taken with the selected Picture Style applied.

Picture Style Effects

Standard

The image looks vivid, sharp, and crisp. This is a general-purpose Picture Style suitable for most scenes.

Portrait

For nice skin tones. The image looks slightly sharp and crisp. Effective for close-ups of women or children. This Picture Style is also selected automatically when the Mode Dial is set to <P>. By changing the [Color tone] (p.83), you can adjust the skin tone.

Landscape

For vivid blues and greens, and very sharp and crisp images. Effective for impressive landscapes. This Picture Style is also selected automatically when the Mode Dial is set to <L>.

Neutral

This is for users who prefer to process images with their personal computer. For natural colors and subdued images.

Faithful

This is for users who prefer to process images with their personal computer. When the subject is captured under a color temperature of 5200K, the color is adjusted colorimetrically to match the subject's color. The image is dull and subdued.

Monochrome

For black-and-white images.

 Other than with **RAW**, the black-and-white image cannot be reverted to color. If you want to later shoot pictures in color, make sure the **[Monochrome]** setting has been canceled. When **[Monochrome]** is selected, **<B/W>** will appear in the viewfinder.

User Def. 1-3

You can register your own Picture Style settings for **[Portrait]**, **[Landscape]**, etc. (p.85) Any User Defined Picture Style which has not been set will have the same settings as the Standard Picture Style.

4



More Advanced Techniques

This chapter builds on the previous chapter and introduces more ways to shoot creatively.

- The first half of this chapter explains how to use the <Tv> <Av> <M> <A-DEP> modes on the Mode Dial. Except for <A-DEP>, all the shooting modes can be used in combination with the functions introduced in Chapter 3.
- The second half of this chapter, starting with “Changing the Metering Mode” explains the methods to adjust the exposure and the Picture Styles. All the functions introduced in this chapter can also be used with the <P> (Program AE) mode introduced in Chapter 3.

About the Main Dial Pointer



The pointer icon  displayed together with the shutter speed, aperture setting, or exposure compensation amount indicates that you can turn the  dial to adjust the respective setting.

Tv: Action Shots

You can either freeze the action or create motion blur with the **<Tv>** (Shutter-priority AE) mode on the Mode Dial.

* **<Tv>** stands for Time value.



Frozen action
(Fast shutter speed)



Blurred action
(Slow shutter speed)



1 Set the Mode Dial to **<Tv>**.

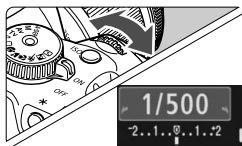

2 Set the desired shutter speed.

- See “Shooting Tips” for advice on setting the shutter speed.
- Turning the  dial to the right sets a faster shutter speed, and turning it to the left sets a slower one.

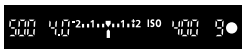

3 Take the picture.

- When you focus and press the shutter button completely, the picture will be taken at the selected shutter speed.



About the Shutter Speed Display

The LCD monitor displays the shutter speed as a fraction. However, the viewfinder displays only the denominator. Also, “0”5” indicates 0.5 sec. and “15” is 15 sec.



Shooting Tips

- **To freeze the action or moving subject.**

Use a fast shutter speed such as 1/4000 sec. to 1/500 sec.

- **To blur a running child or animal giving the impression of fast movement.**

Use a medium shutter speed such as 1/250 sec. to 1/30 sec. Follow the moving subject through the viewfinder and press the shutter button to take the picture. If you use a telephoto lens, hold it steady to prevent camera shake.

- **How to blur a flowing river or water fountain.**

Use a slow shutter speed to 1/15 sec. or slower. Use a tripod to prevent camera shake.

- **Set the shutter speed so that the aperture display does not blink in the viewfinder.**

If you press the shutter button halfway and change the shutter speed while the aperture is displayed, the aperture display will also change to maintain the same exposure (amount of light reaching the image sensor). If you exceed the adjustable aperture range, the aperture display will blink to indicate that the standard exposure cannot be obtained.

If the exposure will be too dark, the lowest aperture will blink. If this happens, turn the <  > dial to the left to set a slower shutter speed or increase the ISO speed.

If the exposure will be too bright, the highest aperture will blink. If this happens, turn the <  > dial to the right to set a faster shutter speed or decrease the ISO speed.



Using the built-in flash

To obtain a correct flash exposure, the flash output will be set to match the automatically-set aperture (autoflash exposure). The flash sync speed can be set from 1/200 sec. to 30 sec.

Av: Changing the Depth of Field

To obtain a blurry background or to make everything near and far look sharp, set the Mode Dial to <Av> (Aperture-priority AE) to adjust the depth of field (range of acceptable focus).

* <Av> stands for Aperture value which is the size of the diaphragm hole inside the lens.



Blurred background
(With a large aperture opening)



Sharp foreground and background
(With a small aperture opening)

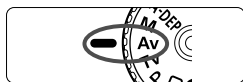

1 Set the Mode Dial to <Av>.

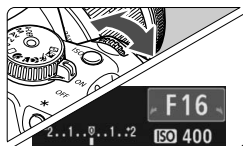

2 Set the desired aperture.

- The higher the aperture, the sharper the picture will look with a wider depth of field.
- Turning the <aperture> dial to the right will set a higher f-number, and turning it to the left will set a lower f-number.

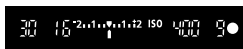

3 Take the picture.

- Focus and press the shutter button completely. The picture will be taken with the selected aperture.



About the Aperture Display

The larger the f/number, the smaller the aperture opening will be. The apertures displayed will differ depending on the lens. If no lens is attached to the camera, "00" will be displayed for the aperture.



Shooting Tips

- **When using a high aperture, note that camera shake can occur in low light scenes.**

A higher aperture will make the shutter speed slower. Under low light, the shutter speed can be as long as 30 sec. In such cases, increase the ISO speed and hold the camera steady or use a tripod.

- **The depth of field depends not only on the aperture, but also the lens and subject distance.**

Since wide-angle lenses have a wide depth of field (range of acceptable focus in front of and behind the point of focus), you need not set a high aperture to obtain a sharp picture from the foreground to the background. On the other hand, a telephoto lens has a narrow depth of field.

And the closer the subject, the narrower the depth of field. A farther subject will have a wider depth of field.

- **Set the aperture so that the shutter speed display does not blink in the viewfinder.**

If you press the shutter button halfway and change the aperture while the shutter speed is displayed, the shutter speed display will also change to maintain the same exposure (amount of light reaching the image sensor). If you exceed the adjustable shutter speed range, the shutter speed display will blink to indicate that the standard exposure cannot be obtained.

If the picture will be too dark, the "30" (30 sec.) shutter speed display will blink. If this happens, turn the  dial to the left to set a lower aperture or increase the ISO speed.

If the picture will be too bright, the "4000" (1/4000 sec.) shutter speed display will blink. If this happens, turn the  dial to the right to set a higher aperture or decrease the ISO speed.



Using the Built-in Flash

To obtain a correct flash exposure, the flash output will be set automatically to match the set aperture (autoflash exposure). The shutter speed will be set automatically between 1/200 sec. - 30 sec. to suit the scene's brightness.



In low light, the main subject is exposed with the automatic flash, and the background is exposed with a slow shutter speed set automatically. Both the subject and background look properly exposed (automatic slow-speed flash sync). If you are handholding the camera, keep it steady to prevent camera shake. Using a tripod is recommended.

To prevent slow-speed sync, select the [If: Custom Functions (C.Fn)] menu's [Flash sync. speed in Av mode] (p.154) and set it to [1: 1/200sec. (fixed)].

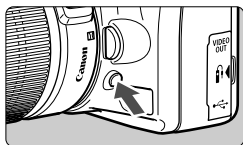
Depth-of-Field Preview ★



Press the depth-of-field preview button to stop down to the current aperture setting. You can check the depth of field (range of acceptable focus) through the viewfinder.

 If it is difficult to discern the depth of field, first set the lowest f-number. Then hold down the depth-of-field preview button and look through the viewfinder while turning the  dial to the right. As the aperture gets smaller, the viewfinder will gradually look darker. You can also see how the depth of field increases.

M: Manual Exposure

You can set both the shutter speed and aperture as desired. With flash, the flash exposure will be set automatically to match the aperture that was set. The flash sync speed can be set within 1/200 sec. to 1/30 sec. or to bulb.

* <M> stands for Manual.



1 Set the Mode Dial to <M>.



2 Set the shutter speed and aperture.

- To set the shutter speed, turn the < &img alt="shutter speed dial icon" data-bbox="315 310 355 330"/> > dial.
- To set the aperture, hold down the < Av &img alt="Av button icon" data-bbox="255 335 275 355"/> > button and turn the < &img alt="aperture dial icon" data-bbox="825 355 865 375"/> > dial.

Standard exposure index



Exposure level mark

3 Set the exposure and take the picture.

- The exposure level indicator in the viewfinder indicates the exposure level up to ± 2 stops from the standard exposure index at the center. While you change the shutter speed and aperture, the exposure level mark will move. You can decide which exposure level to set.

Bulb Exposures

In step 2, turn the < &img alt="shutter speed dial icon" data-bbox="315 700 355 720"/> > dial left to set <BULB>. A bulb exposure keeps the shutter open for as long as you hold down the shutter button. It can be used to photograph fireworks, etc. The elapsed exposure time will be displayed on the LCD monitor.

For bulb exposures, using a Remote Switch (p.164) is recommended.



- Since bulb exposures produce more noise than usual, the image will look rough or grainy. You can reduce this noise by setting the [**IF: Custom Functions (C.Fn)**] menu's [**Long exp. noise reduction**] (p.155) to [**1: Auto**] or [**2: On**].
- The Auto Lighting Optimizer (p.156) will not work.

A-DEP: Automatic Depth-of-Field AE

Objects in the foreground and background will be in focus automatically. All the AF points will function to detect the subject, and the aperture required to attain the necessary depth of field will be set automatically.

* <A-DEP> stands for Auto-Depth of field. This mode sets the depth of field automatically.



1 Set the Mode Dial to <A-DEP>.



2 Focus the subject.

- Aim the AF points over the subjects and press the shutter button halfway. (⌚4)
- All the subjects covered by the AF points flashing in red will be in focus.

3 Take the picture.

? FAQ

● The aperture display in the viewfinder blinks.

The exposure is correct, but the desired depth of field cannot be obtained. Either use a wide-angle lens or move farther away from the subjects.

● The shutter speed display in the viewfinder blinks.

If the "30" shutter speed blinks, it means that the subject is too dark. Increase the ISO speed. If the "4000" shutter speed blinks, it means that the subject is too bright. Decrease the ISO speed.

● A slow shutter speed has been set.

Use a tripod.

● I want to use flash.

Flash can be used, however, the result will be the same as using the <P> mode with flash. The desired depth of field will not be obtained.

Changing the Metering Mode ★

The metering mode is the method of measuring the brightness of the subject. Normally, evaluative metering is recommended.

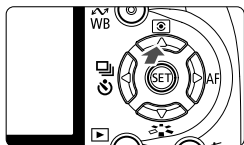

- 1 Press the <▲  > button.**
 - ▶ [Metering mode] will appear.

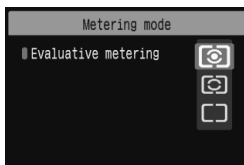

- 2 Select the metering mode.**
 - Press the <▲▼> key to select the metering mode, then press <SET>.

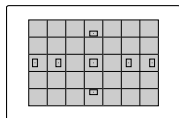

Evaluative metering

This is an all-around metering mode suited for portraits and even backlit subjects. The camera sets the exposure automatically to suit the scene. This metering mode is set automatically in the Basic Zone modes.

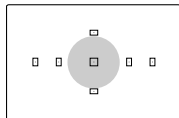

Partial metering

Effective when the background is much brighter than the subject due to backlighting, etc. The gray area in the left figure is where the metering is weighted to obtain the standard exposure.

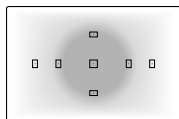

Center-weighted average metering

The metering is weighted at the center and then averaged for the entire scene. This metering mode is for advanced users.

Setting Exposure Compensation ★

Exposure compensation is used to alter the standard exposure set by the camera. You can make the image look brighter (increased exposure) or darker (decreased exposure). **The exposure compensation setting will not be automatically canceled when you turn off the camera. After taking the picture, reset the exposure compensation to zero.**

Av Setting Exposure Compensation

Set exposure compensation if the exposure (without flash) does not come out as desired. This feature can be used in the Creative Zone modes (except <M>).

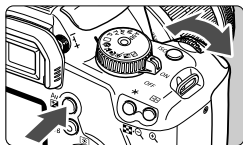

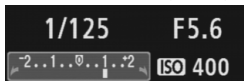

Increased exposure for a brighter image



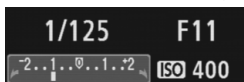

Decreased exposure for a darker image





Making it brighter

Hold down the <Av > button and turn the <> dial to the right.
(Increased exposure)

Making it darker

Hold down the <Av > button and turn the <> dial to the left.
(Decreased exposure)

- ▶ As shown in the figure, the exposure level is displayed on the LCD monitor and in the viewfinder.

- After taking the picture, hold down the <Av > button and turn the <> dial to reset the exposure compensation to zero.



Exposure is dark



Exposure compensation made it brighter

Flash Exposure Compensation *

Set flash exposure compensation if the flash exposure of the subject does not come out as desired. This feature also works with external EX-series Speedlites.

1 Select [Flash exp comp].

- Under the [] tab, select [Flash exp comp], then press <SET>.



2 Set the exposure compensation amount.



- To make the flash exposure brighter, press the <▶> key. (Increased exposure)
Or to make it darker, press the <◀> key. (Decreased exposure)
- After setting the flash exposure compensation amount, press <SET>.
- When you press the shutter button halfway, the <Flash icon> and flash exposure compensation amount will be displayed on the LCD monitor and the <Flash icon> icon will appear in the viewfinder.
- After taking the picture, do step 2 to reset the flash exposure compensation amount to zero.



A bright flash exposure



Flash exposure compensation making it darker

 If the [ Custom Functions (C.Fn)] menu's [Auto Lighting Optimizer] (p.156) is set to [0: Enable], the exposure compensation and flash exposure compensation may not be effective. Set it to [1: Disable] if you want to obtain the results of the exposure compensation setting.

MENU Auto Exposure Bracketing ★

This feature takes exposure compensation a step further by varying the exposure automatically with three shots as shown below. You can then choose the best exposure. This is called AEB (Auto Exposure Bracketing).



Standard exposure



Darker exposure
(Decreased exposure)



Brighter exposure
(Increased exposure)

1 Select [AEB].

- Under the [AEB] tab, select [AEB], then press <SET>.

AEB amount



2 Set the AEB amount.

- Press the <◀▶> key to set the AEB amount, then press <SET>.
- When you press the shutter button halfway, the AEB amount will be displayed on the LCD monitor.

3 Take the picture.

- Focus and press the shutter button completely. With the current drive mode (p.63), the three bracketed shots will be taken in this sequence: Standard, decreased, and increased exposure.

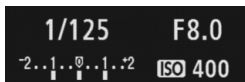

Canceling AEB



- Follow steps 1 and 2 to set the AEB amount to < -2..1..0..1..2 >.
- The AEB setting will be canceled automatically if the power switch is set to <OFF>, obtain flash-ready, etc.



Shooting Tips

- **Using AEB with continuous shooting.**
If < [] > continuous shooting (p.63) has been set and you press the shutter button completely, the three bracketed shots will be taken continuously in this sequence: Standard, decreased, and increased exposure.
 - **Using AEB with < [] > single shooting.**
Press the shutter button three times to take the three bracketed shots. The three bracketed shots will be exposed in the following sequence: Standard, decreased, and increased exposure.
 - **Using AEB with exposure compensation.**
Centering on the exposure compensation amount, AEB will be taken.
 - **Using AEB with the self-timer.**
With self-timer < []₁₀ > or < []₂ >, you can take three continuous shots. With < []_C > set, the number of continuous shots will be three times the number set (p.53).
- Neither flash nor bulb exposures can be used with AEB.
 - If the [Fn: Custom Functions (C.Fn)] menu's [Auto Lighting Optimizer] (p.156) is set to [0: Enable], the AEB may not be effective. Set it to [1: Disable] if you want to obtain the results of the AEB setting.

Customizing the Picture Style [★]

You can customize a Picture Style by adjusting individual parameters like **[Sharpness]** and **[Contrast]**. To see the resulting effects, take test shots. To customize **[Monochrome]**, see page 84.



1 Select [Picture Style].

- Under the **[Pict.]** tab, select **[Picture Style]**, then press **<SET>**.
- ▶ The Picture Style selection screen will appear.



2 Select a Picture Style.

- Select a Picture Style, then press the **<DISP.>** button.
- ▶ The Detail set. screen will appear.

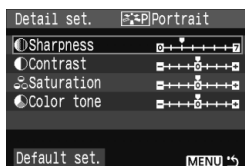

3 Select a parameter.

- Select a parameter such as **[Sharpness]**, then press **<SET>**.



4 Set the parameter.

- Press the **<◀▶>** key to adjust the parameter as desired, then press **<SET>**.
- Press the **<MENU>** button to save the adjusted parameter. The Picture Style selection screen will reappear.
- ▶ Any parameter settings different from the default will be displayed in blue.

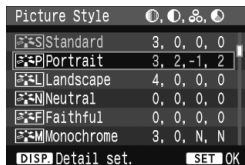

Parameter Settings and Effects

Sharpness

Adjusts the sharpness of the image.

To make it less sharp, set it toward the **0** end. The closer it is to **0**, the softer the image will look.

To make it sharper, set it toward the **7** end. The closer it is to **7**, the sharper the image will look.

Contrast

Adjusts the image contrast and the vividness of colors.

To decrease the contrast, set it toward the minus end. The closer it is to **-**, the blander the image will look.

To increase the contrast, set it toward the plus end. The closer it is to **+**, the crisper the image will look.

Saturation

The image's color saturation can be adjusted.

To decrease the color saturation, set it toward the minus end. The closer it is to **-**, the lighter the colors will look.

To increase the color saturation, set it toward the plus end. The closer it is to **+**, the more saturated the colors will look.

Color tone

The skin tones can be adjusted.

To make the skin tone redder, set it toward the minus end. The closer it is to **-**, the redder the skin tone will look.

To make the skin tone less red, set it toward the plus end. The closer it is to **+**, the more yellow the skin tone will look.



By selecting [**Default set.**] in step 3, you can revert the respective Picture Style to its default parameter settings.

Monochrome Adjustment

For Monochrome, you can also set **[Filter effect]** and **[Toning effect]** in addition to **[Sharpness]** and **[Contrast]** explained on the preceding page.

Filter Effect

With a filter effect applied to a monochrome image, you can make white clouds or green trees stand out more.

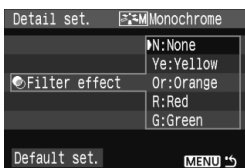

Filter	Sample Effects
N: None	Normal black-and-white image with no filter effects.
Ye: Yellow	The blue sky will look more natural, and the white clouds will look crisper.
Or: Orange	The blue sky will look slightly darker. The sunset will look more brilliant.
R: Red	The blue sky will look quite dark. Fall leaves will look crisper and brighter.
G: Green	Skin tones and lips will look fine. Tree leaves will look crisper and brighter.

Setting the **[Contrast]** to the plus side will make the filter effect more pronounced.

Toning Effect

By applying a toning effect, you can create a monochrome image in that color. It can make the image look more impressive.

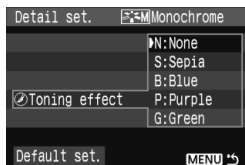

The following can be selected: **[N:None]** **[S:Sepia]** **[B:Blue]** **[P:Purple]** **[G:Green]**.

Registering the Picture Style ★

You can select a base Picture Style such as [Portrait] or [Landscape], adjust its parameters as desired and register it under [User Def. 1], [User Def. 2], or [User Def. 3].

You can create Picture Styles whose parameter settings such as for sharpness and contrast are different. You can also adjust the parameters of a Picture Style which has been registered to the camera with the provided software.

1 Select [Picture Style].

- Under the [P²] tab, select [Picture Style], then press <SET>.
- ▶ The Picture Style selection screen will appear.

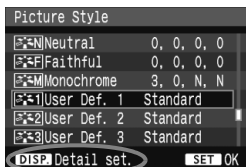

2 Select [User Def.].

- Select [User Def. *], then press the <DISP.> button.
- ▶ The Detail set. screen will appear.

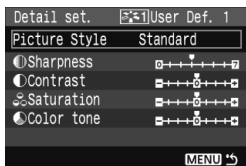

3 Press <SET>.

- With [Picture Style] selected, press <SET>.



4 Select the base Picture Style.

- Press the <▲▼> key to select the base Picture Style, then press <SET>.
- To adjust the parameters of a Picture Style which has been registered to the camera with the provided software, select the Picture Style here.

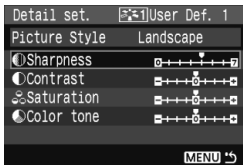

5 Select a parameter.

- Select a parameter such as **[Sharpness]**, then press **<SET>**.



6 Set the parameter.

- Press the **<◀▶>** key to adjust the parameter as desired, then press **<SET>**.

For details, see “Customizing the Picture Style” on pages 82-84.

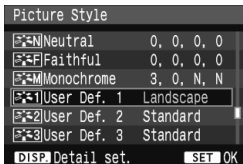

- Press the **<MENU>** button to register the new Picture Style. The Picture Style selection screen will then reappear.
 - ▶ The base Picture Style will be indicated on the right of **[User Def. *]**.
 - ▶ The name of the Picture Style having any modified settings (different from the default) registered under **[User Def. *]** will be displayed in blue.

 If a Picture Style has already been registered under **[User Def. *]**, changing the base Picture Style in step 4 will nullify the parameter settings of the registered Picture Style.

MENU Setting the Color Space ★

The color space refers to the range of reproducible colors. With this camera, you can set the color space for captured images to sRGB or Adobe RGB. For normal images, sRGB is recommended. In the Basic Zone modes, sRGB is set automatically.

1 Select [Color space].

- Under the [M:] tab, select [Color space], then press <SET>.

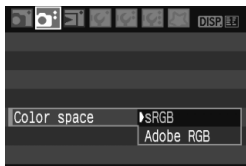

2 Set the desired color space.

- Select [sRGB] or [Adobe RGB], then press <SET>.

About Adobe RGB

This is mainly used for commercial printing and other industrial uses. This setting is not recommended if you do not know about image processing, Adobe RGB, and Design rule for Camera File System 2.0 (Exif 2.21).

Since the image will look very subdued with an sRGB personal computer environment and printers not compatible with Design rule for Camera File System 2.0 (Exif 2.21), post-processing of the image with software will be required.



- If the image is captured with the color space set to Adobe RGB, the file name will start with “_MG_” (first character is an underscore).
- The ICC profile is not appended. The ICC profile is explained in the Software Instruction Manual in the CD-ROM.

* AE Lock *

Use AE lock when the area of focus is to be different from the exposure metering area or when you want to take multiple shots at the same exposure setting. Press the < * > button to lock the exposure, then recompose and take the shot. This is called AE lock. It is effective for backlit subjects.

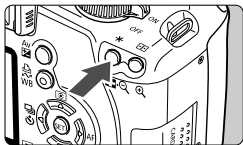

1 Focus the subject.

- Press the shutter button halfway.
- ▶ The exposure setting will be displayed.

2 Press the < * > button. (☉4)

- ▶ The < * > icon lights in the viewfinder to indicate that the exposure setting is locked (AE lock).
- Each time you press the < * > button, it locks the current auto exposure setting.



3 Recompose and take the picture.

- If you want to maintain the AE lock while taking more shots, hold down the < * > button and press the shutter button to take another shot.



AE Lock Effects

Metering Mode (p.77)	AF Point Selection Method	
	Automatic Selection	Manual Selection
*	AE lock is applied at the AF point that achieved focus.	AE lock is applied at the selected AF point.
	AE lock is applied at the center AF point.	

* When the lens' focus mode switch is set to <MF>, AE lock is applied at the center AF point.

* FE Lock *

FE lock locks the flash exposure setting over the desired area of the subject. This feature also works with external EX-series Speedlites.

* FE stands for Flash Exposure.

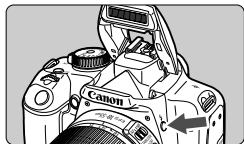

1 Press the $\lt; \text{lightning bolt} \gt;$ button to pop-up the built-in flash.

- Press the shutter button halfway and look in the viewfinder to check that the $\lt; \text{lightning bolt} \gt;$ icon is lit.

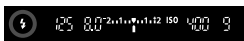

2 Focus the subject.

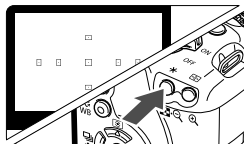

3 Press the $\lt; * \gt;$ button. (16)

- Aim the viewfinder center over the subject where you want to lock the flash exposure, then press the $\lt; * \gt;$ button.
- ▶ The flash will fire a preflash and the required flash output is calculated and retained in memory.
- ▶ In the viewfinder, "FEL" is displayed for a moment and $\lt; \text{lightning bolt} * \gt;$ will light.
- Each time you press the $\lt; * \gt;$ button, a preflash is fired and the required flash output is calculated and retained in memory.

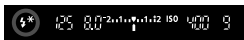

4 Take the picture.

- Compose the shot and press the shutter button completely.
- ▶ The flash is fired to take the picture.



If the subject is too far away and beyond the effective range of the flash, the $\lt; \text{lightning bolt} \gt;$ icon will blink. Get closer to the subject and repeat steps 2 to 4.

WB: Setting the White Balance ★

White balance (WB) is for making the white areas look white. Normally, the <AWB> (Auto) setting will obtain the correct white balance. If natural-looking colors cannot be obtained with <AWB>, you can select the white balance for each light source or set it manually by shooting a white object. In the Basic Zone modes, <AWB> will be set automatically.

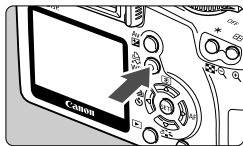

1 Press the <WB> button.

- ▶ [White balance] will appear.

2 Select the white balance.

- Press the <◀▶> key to select the desired white balance, then press <SET>.
- The "Approx. ****K" (K: Kelvin) displayed for the selected white balance <☀> <🏠> <☁> <🔦> <🌞> is the respective color temperature.

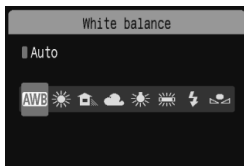

📷 Custom White Balance

Custom white balance enables you to manually set the white balance for a specific light source for better accuracy. Do this procedure under the actual light source to be used.

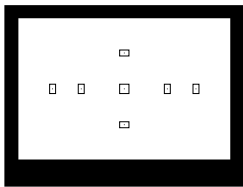

1 Photograph a white object.

- The plain, white object should fill the viewfinder center.
- Focus manually and set the standard exposure for the white object.
- You can set any white balance.



2 Select [Custom WB].

- Under the [Dⁱ] tab, select [Custom WB], then press <SET>.
- ▶ The SET screen will appear.

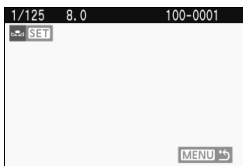

3 Import the white balance data.

- Select the image that was captured in step 1, then press <SET>.
- ▶ On the dialog screen which appears, select [OK] and the data will be imported.
- When the menu reappears, press the <MENU> button to exit the menu.



4 Select the custom white balance.

- Press the <WB> button.
- Press the <◀▶> key to select <[WB]>, then press <SET>.



- If the exposure obtained in step 1 is way off, a correct white balance might not be obtained.
- If the image was captured while the Picture Style was set to [Monochrome] (p.68), it cannot be selected in step 3.

MENU White Balance Correction [★]

You can correct the white balance that has been set. This adjustment will have the same effect as using a commercially-available color temperature conversion filter or color compensating filter. Each color can be corrected to one of nine levels.

This is for advanced users who are familiar with using color temperature conversion or color compensating filters.

White Balance Correction



1 Select [WB SHIFT/BKT].

- Under the [WB] tab, select [WB SHIFT/BKT], then press <SET>.
- ▶ The WB correction/WB bracketing screen will appear.

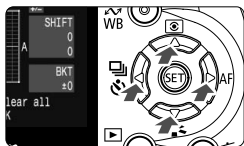

2 Set the white balance correction.

- Press the <◀▶> key to move the "■" mark to the desired position.
- B is for blue, A is amber, M is magenta, and G is green. The color in the respective direction will be corrected.
- On the upper right, "SHIFT" indicates the direction and correction amount.
- Pressing the <DISP.> button will cancel all the [WB SHIFT/BKT] settings.
- Press <SET> to exit the setting and return to the menu.

Sample setting: A2, G1

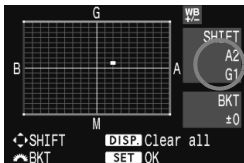

- During the white balance correction, <WB ±> will be displayed in the viewfinder and on the LCD monitor.
- One level of the blue/amber correction is equivalent to 5 mireds of a color temperature conversion filter. (Mired: A measurement unit indicating the density of a color temperature conversion filter.)

White Balance Auto Bracketing

With just one shot, three images having a different color tone can be recorded simultaneously. Based on the color temperature of the current white balance setting, the image will be bracketed with a blue/amber bias or magenta/green bias. This is called white balance bracketing (WB-BKT). White balance bracketing is possible up to ± 3 levels in single-level increments.

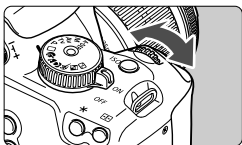

B/A bias ± 3 levels

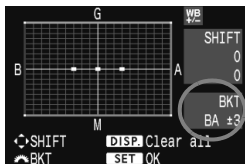

Set the white balance bracketing amount.

- In step 2 for white balance correction, when you turn the dial, the "■" mark on the screen will change to "■■■" (3 points). Turning the dial to the right sets the B/A bracketing, and turning it to the left sets the M/G bracketing.
- ▶ On the right side of the screen, "BKT" indicates the bracketing direction and the bracketing amount is also displayed.
- Pressing the <DISP.> button will cancel all the [WB SHIFT/BKT] settings.
- Press <SET> to exit the setting and return to the menu.

Bracketing Sequence

The images will be bracketed in the following sequence: 1. Standard white balance, 2. Blue (B) bias, and 3. Amber (A) bias, or 1. Standard white balance, 2. Magenta (M) bias, 3. Green (G) bias.

- During WB bracketing, the maximum burst for continuous shooting will be lower and the number of possible shots will also decrease to one-third the normal number. If the [Fn: Custom Functions (C.Fn)] menu's [High ISO speed noise reduction] (p.155) is set to [1: On], WB bracketing will not be possible.



- Since three images are recorded for one shot, the card will take longer to record the shot.
- "BKT" stands for Bracketing.

Preventing Camera Shake ★

The camera's mechanical shake caused by the reflex mirror action can affect images taken with a super telephoto lens or close-up (macro) lens. In such cases, mirror lockup is effective.

Mirror lockup is enabled by selecting [19: Custom Functions (C.Fn)] and setting [Mirror lockup] (p.157) to [1: Enable].

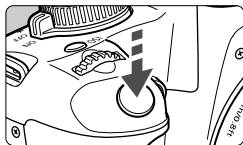

- Focus the subject and press the shutter button completely. The reflex mirror will lock up.
- Then press the shutter button completely again to take the picture. The reflex mirror will then go back down.



Shooting Tips

- **Using the self-timer <S2> with mirror lockup.**

When you press the shutter button completely, the mirror locks up, then the picture is taken 2 sec. later.

- Do not point the camera toward the sun. The sun's heat can scorch and damage the shutter curtains.
- If you use bulb exposures, the self-timer, and mirror lockup in combination, keep pressing the shutter button completely (self-timer delay time + bulb exposure time). If you let go of the shutter button during the self-timer countdown, there will be a shutter-release sound. However, this is not the actual shutter release (no picture is taken).

- Even if <C> (Continuous shooting) has been set, single shooting will still take effect.
- The mirror locks up, and after 30 seconds, it will go back down automatically. Pressing the shutter button completely again locks up the mirror again.

5

Live View Shooting

You can shoot while viewing a real-time image on the camera's LCD monitor or on a personal computer screen. This is called "Live View shooting."

Convenient when the camera is mounted on a tripod for shooting still lifes, for example.

📷 If you handhold the camera like a compact digital camera and shoot while viewing the LCD monitor, camera shake can cause blurred images.

About Remote Live View Shooting

With the provided software installed in the personal computer, you can connect the camera to the personal computer and shoot remotely while viewing the computer screen instead of the camera's viewfinder. For details, see the Software Instruction Manual in the CD-ROM.

Preparing for Live View Shooting★

Set the camera for Live View shooting.

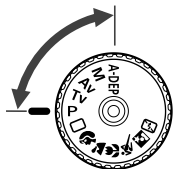

1 Set the shooting mode.

- Set the shooting mode to a Creative Zone mode.
- **Live View shooting does not work in Basic Zone modes.**

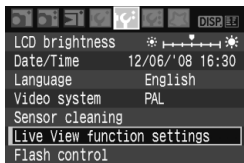

2 Select [Live View function settings].

- Under the [F:] tab, select [**Live View function settings**], then press <SET>.

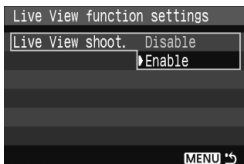

3 Select [Live View shoot.].

- Select [**Live View shoot.**], then press <SET>. Select [**Enable**], then press <SET>.

4 Exit the menu.

- Press the <MENU> button to exit.



5 Display the Live View image.

- Press <SET>.
- ▶ The Live View image will appear on the LCD monitor.
- The Live View image will reflect the brightness level of the actual image you capture.
- If the image is too bright, turn the <☀> dial to the right. If it is too dark, turn the <☀> dial to the left.



- During Live View shooting, do not point the camera toward the sun. The sun's heat can damage the camera's internal components.
- Live View shooting will disable a few Custom Function settings. (p.153)
- Under low light or bright light conditions, the Live View image might not reflect the brightness of the captured image.
- If the light source within the image changes, the screen might flicker. If this happens, stop the Live View shooting, then resume Live View shooting under the actual light source to be used.
- During Live View image display, if you point the camera in a different direction, it might throw off the correct brightness momentarily and the image might not look right. Wait until the image brightness stabilizes before shooting.
- If there is a very bright light source in the picture, such as the sun, the bright area might be blackened on the LCD monitor. However, the actual captured image will correctly show the bright area.
- If you set the [**IF**: **LCD brightness**] to bright settings in low light, chrominance noise may appear in the Live View image. However, the chrominance noise will not be recorded to the captured image.
- When you magnify the image, the image sharpness may look more pronounced than it really is.
- Under the [**IF**: **Custom Functions (C.Fn)**] menu, setting [**Auto Lighting Optimizer**] (p.156) to [**0: Enable**] may display a darkly-exposed (set with exposure compensation) image brighter.



- If the camera is not operated for a prolonged period, the power will turn off automatically as set with [**IF**: **Auto power off**]. (p.109) If [**IF**: **Auto power off**] is set to [**Off**], the Live View shooting will stop automatically after 30 min. (camera power remains on).
- The image's field of view is about 100%.
- With the video cable (provided) connecting the camera to a TV set, you can view images on the TV. (p.128)

Focusing Manually [★]

Although autofocus can be used (p.102, 104), magnifying the image and focusing manually is recommended for precise focusing.

Magnifying the Image for Manual Focusing

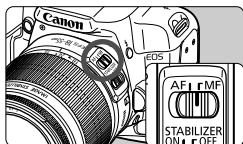

1 Set the lens focus mode switch to <MF>.

- Turn the lens focusing ring to focus roughly.

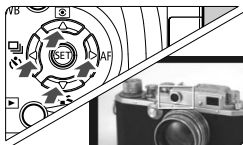

2 Move the focusing frame to the position where you want to focus.

- Press the <◇> key to move the focusing frame.
- To move to the center focusing frame, press the <☒> button.

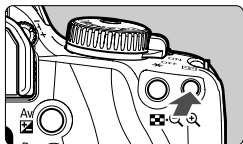

3 Magnify the image.

- Press the <Ⓚ> button.
- ▶ The area within the focusing frame will be magnified.
- Each time you press the <Ⓚ> button, the display format will change as follows:

→ 5x → 10x → Full view

Magnification: 10x

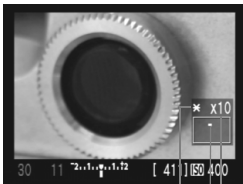

AE lock
Magnified area
Magnification

4 Focus manually.

- While looking at the magnified image, turn the lens focusing ring to focus.
- After achieving focus, press the <Ⓚ> button to return to the full view.

Shooting [★]



1 Check the exposure.

- Press the shutter button halfway.
- ▶ The shutter speed and aperture will be displayed.
- If you set exposure compensation, the image brightness will change accordingly.

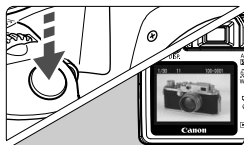

2 Take the picture.

- Press the shutter button completely.
- ▶ The picture will be taken and the captured image is displayed on the LCD monitor.
- ▶ After the image review ends, the camera will return to Live View shooting automatically.

3 Exit Live View shooting.

- With the Live View image displayed, press **<SET>**.

About the Shooting Settings

- **<A-DEP>** will be the same as using **<P>**.
- You can set the ISO speed, white balance, and exposure compensation during Live View shooting.
- The Picture Style, drive mode, AF mode, and AF point cannot be changed during Live View shooting.
- During Live View shooting, the metering mode will be set to evaluative metering regardless of the current metering mode setting.
- You can check the depth of field by pressing the depth-of-field preview button.
- During continuous shooting, the exposure set for the first shot will also be applied to subsequent shots.

Battery Life with Live View Shooting [Approx. number of shots]

Temperature	Shooting Conditions	
	No Flash	50% Flash Use
At 23°C / 73°F	200	190
At 0°C / 32°F	190	180

- The figures above are based on a fully-charged LP-E5 battery and CIPA (Camera & Imaging Products Association) testing standards.
- Autofocusing will decrease the number of possible shots.



- When you use Live View shooting for a long period, the camera's internal temperature may increase and it can degrade image quality. Terminate Live View shooting when not shooting images. Before taking a long exposure, stop Live View shooting temporarily and wait several minutes before shooting.
- High temperatures, high ISO speeds, or long exposures may cause noise or irregular colors in the image captured with Live View shooting.
- If you take the picture while the image is magnified, the exposure might not come out as desired. Return to the full view before taking the picture. During the magnified view, the shutter speed and aperture will be displayed in red.
- Even if you take the picture during magnified view, the captured image will reflect the full view.
- The focus preset feature on super telephoto lenses cannot be used.
- For Live View shooting, do not use an Extension Tube or TS-E lens. Doing so can cause irregular or unintended exposures.
- FE lock is not possible when the built-in flash or external Speedlite is used. Modeling flash is not possible when external Speedlite is used.
- A non-Canon flash will not fire.



- A grid can be displayed. Under [**Live View function settings**], set [**Grid display**] to [**On**].
- You can change the metering timer. Under [**Live View function settings**], set [**Metering timer**].
- When you take a picture with flash, it will sound like two pictures were taken. However, only one picture is taken.

About the Information Display

- Each time you press the <DISP.> button, the information display will change.

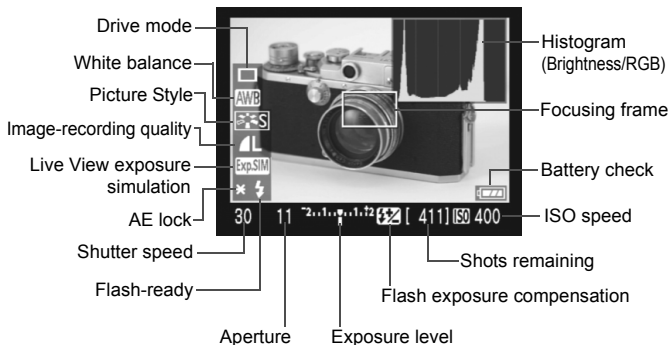

- When <Exp.SIM> is displayed in white, it indicates that the Live View image brightness is close to what the captured image will look like.
- If <Exp.SIM> is blinking, it indicates that the Live View image is not being displayed at the suitable brightness due to low or bright light conditions. However, the captured image will reflect the exposure setting.
- If flash is used or bulb is set, the <Exp.SIM> icon and histogram will be grayed out. The histogram might not be properly displayed in low light or bright light conditions.

Using AF to Focus ★

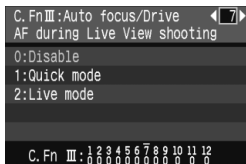

Under [**IF: Custom Functions (C.Fn)**], when [**AF during Live View shooting**] (p.157) is set to [**1: Quick mode**] or [**2: Live mode**], you can focus with AF. Quick mode and Live mode use a different AF method. If you want precise focusing, magnify the image and focus manually. (p.98)

C.Fn-7-1: Quick mode

This is the same as using AF (p.60, 61) as usual with the dedicated AF sensor. Although you can focus the desired area quickly, the Live View image will be interrupted momentarily during the AF operation.

Set to Quick mode, the lens focus mode switch to <AF>, and the AF mode to <ONE SHOT>.

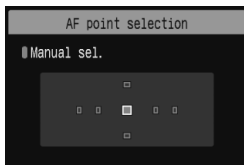

1

Select the AF point.

- Before starting Live View shooting, select the AF point.
- Press the <AF-ON> button and press the <DIRECTION> key to select the AF point.
- Press the shutter button halfway for shooting ready.

2

Display the Live View image.

- Press <SET>.
- ▶ The Live View image will appear on the LCD monitor.
- The selected AF point will be displayed.
- The focusing frame (larger frame) will also be displayed.

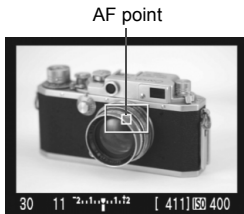

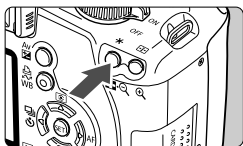

3 Focus the subject.

- Aim the selected AF point over the subject, and hold down the < * > button.
- ▶ The Live View image will turn off, the reflex mirror will go back down, and AF will be executed.
- ▶ When focus is achieved, the beeper will sound.



4 Return to the Live View image display and shoot.

- When you let go of the < * > button, the Live View image will reappear.
- Check the focus and exposure, then press the shutter button to take the picture (p.99).



- You cannot take a picture during autofocus. Take the picture only while the Live View image is displayed.
- You can move the focusing frame with the < + > keys. To magnify the area within the focusing frame, press the < Q > button.
- Although you can set the AF mode to AI Servo AF or AI Focus AF, AF will stop when the camera returns to the Live View image display (step 4), so you cannot focus the moving subject.
- If you want AF and AE lock to work separately, select the [Fn: Custom Functions (C.Fn)] menu's [Shutter/AE lock button] (p.158) and set it to [1: AE lock/AF].
- AF is not possible with Remote Switch RS-60E3 (sold separately).

C.Fn-7-2: Live mode

The image sensor is used to focus. Although AF is possible with the Live View image displayed, the AF operation will take longer than with Quick mode. Also, achieving focus may be more difficult than with Quick mode.

Set to Live mode and the lens focus mode switch to <AF>.



1 Display the Live View image.

- Press <SET>.
- ▶ The Live View image will appear on the LCD monitor.
- When Live mode is set, the AF point <□> will be displayed.

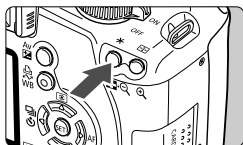

2 Focus the subject.

- Aim the AF point over the subject, and hold down the <∗> button.
- ▶ When focus is achieved, the AF point will turn green and the beeper will sound.
- ▶ If focus is not achieved, the AF point will turn orange.



3 Take the picture.

- Check the focus and exposure, then press the shutter button to take the picture (p.99).

About the AF point with Live mode

- You can press the <⬅➡> keys to move the AF point to where you want to focus (it cannot go to the edges of the picture). To move to the center AF point, press the <⏏> button.
- To magnify the image at the AF point, press the <🔍> button.



- If focusing is difficult with the magnified image, return to the full view and use AF.
- If the image flickers, making it difficult to focus, stop the Live View shooting and resume Live View shooting under the actual light source to be used. Check that the flickering has stopped, then autofocus.
- If you autofocus in the full view, then magnify the image, the focus might be off.
- The AF-assist beam will not be emitted.
- AF is not possible with Remote Switch RS-60E3 (sold separately).



- Depending on the subject or the lens used, achieving focus may be difficult or take some time. In such cases, focus manually (p.98) or autofocus with Quick mode. (p.102)
- Even when focus has been achieved, if you press the <✳> button again, the lens will move to focus again.
- The image brightness may change during and after the AF operation.
- If you want AF and AE lock to work separately, select the [**IF: Custom Functions (C.Fn)**] menu's [**Shutter/AE lock button**] (p.158) and set it to [**1: AE lock/AF**].
- The AF speed may be different during the full view and magnified view.

With Live mode, AF can fail to achieve focus in the following cases:

- Low-contrast subject such as a blue sky and solid-color surfaces.
- Subjects in low light.
- Stripes and other patterns where there is contrast only in the horizontal direction.
- Under a light source whose brightness, color, or pattern keeps changing.
- Night scenes or points of light.
- Under fluorescent lighting or when the image flickers.
- Extremely small subjects.
- Subjects strongly reflecting light.
- The AF point covers both a near and faraway subject (such as an animal in a cage).
- Subjects which keep moving within the AF point and cannot keep still due to camera shake or subject blur.
- A subject approaching or leaving the camera.
- Autofocusing while the subject is way out of focus.
- Soft focus effect is applied with a soft focus lens.
- A special effects filter is used.

6

Handy Features

- Silencing the Beeper (p.108)
- Card Reminder (p.108)
- Setting the Image Review Time (p.108)
- Setting the Auto Power-off Time (p.109)
- Setting the LCD Monitor Brightness (p.109)
- File Numbering Methods (p.110)
- Auto Image Rotation (p.112)
- Checking Camera Function Settings (p.113)
- Reverting the Camera to the Default Settings (p.114)
- Preventing the LCD Monitor from Turning off Automatically (p.115)
- Changing the Shooting Settings Screen Color (p.115)
- Flash Control (p.116)
- Automatic Sensor Cleaning (p.118)
- Appending Dust Delete Data (p.119)
- Manual Sensor Cleaning (p.121)

Handy Features

MENU Silencing the Beeper

You can prevent the beeper from sounding when focus is achieved or during self-timer operation.



Under the [M] tab, select **Beep**, then press <SET>. Select **Off**, then press <SET>.

MENU Card Reminder

This prevents shooting if there is no card in the camera.



Under the [M] tab, select **Shoot w/o card**, then press <SET>. Select **Off**, then press <SET>.

If there is no card installed and you press the shutter button, "Card" will be displayed in the viewfinder, and you cannot release the shutter.

MENU Setting the Image Review Time

How long the image is displayed on the LCD monitor immediately after capture can be set. If **Off** is set, the image review will not be displayed. If **Hold** is set, the image review will be displayed up until the **Auto power off** time. During the image review, if you operate any camera controls such as pressing the shutter button halfway, the image display will end.

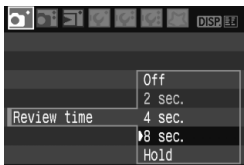

Under the [M] tab, select **Review time**, then press <SET>. Set the time, then press <SET>.

MENU Setting the Auto Power-off Time

To save battery power, the camera turns off automatically after the set time of idle operation elapses. You can set this auto power-off time. When the camera has turned off due to auto power off, you can wake up the camera by pressing the shutter button halfway or any of the following buttons: <MENU> <DISP.> <▶> <Ⓢ> etc.

If [Off] has been set, either turn off the camera yourself or press the <DISP.> button to turn off the shooting settings display to save battery power.

If [Off] has been set and the camera is not used for 30 min., the LCD monitor will turn off automatically. To turn on the LCD monitor again, press the <DISP.> button.



Under the [**IF**] tab, select [**Auto power off**], then press <Ⓢ>. Set the time, then press <Ⓢ>.

MENU Setting the LCD Monitor Brightness

You can adjust the brightness of the LCD monitor to make it easier to read.

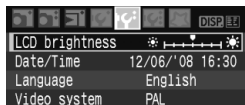

Under the [**IF**] tab, select [**LCD brightness**], then press <Ⓢ>. With the adjustment screen displayed, press the <◀▶> key to adjust the brightness, then press <Ⓢ>.



When checking the exposure of an image, set the LCD monitor brightness to 4 and prevent the ambient light from affecting the reviewed image.

MENU File Numbering Methods

The file number is like the frame number on a roll of film. The captured images are assigned a sequential file number from 0001 to 9999 and saved in one folder. You can change how the file number is assigned. The file number will appear on the personal computer in this format: **IMG_0001.JPG**.

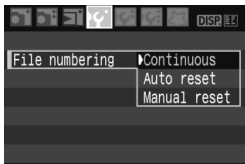

Under the **[Y]** tab, select **[File numbering]**, then press **<SET>**. Follow the steps below to select a file numbering method, then press **<SET>**.

- **[Continuous]: The file numbering continues in sequence even after the card is replaced.**

Even after you replace the card, the file numbering continues in sequence up to 9999. This is convenient when you want to save the images numbered anywhere between 0001 to 9999 in one folder in your personal computer.

However, if the replacement card contains images recorded previously, the file numbering of the new images might continue from the file numbering of the existing images in the card. If you want to use continuous file numbering, you should use a newly-formatted card each time.

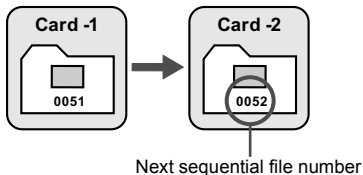
File numbering after replacing the card

- **[Auto reset]: Resets the file numbering to 0001 whenever the card is replaced.**

Each time you replace the card, the file numbering restarts from 0001. This is convenient if you want to organize images according to cards.

However, if the replacement card contains images recorded previously, the file numbering of the new images might continue from the file numbering of the existing images in the card. To restart the file numbering from 0001, you should use a newly-formatted card.

File numbering after replacing the card

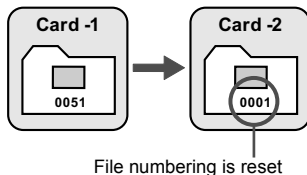

- **[Manual reset]: You can reset the file numbering to 0001 at any time or for a new folder.**

When you reset the file numbering manually, a new folder is created automatically and the file numbering of images saved to that folder starts from 0001. This is convenient when you want to use different folders for the images taken yesterday and the ones taken today, for example. After the manual reset, the file numbering returns to continuous or auto reset.



If folder No. 999 is created, **[Folder number full]** will appear on the LCD monitor. If that folder contains images reaching file number 9999, shooting will not be possible even if the card still has storage capacity. The LCD monitor will display a message to replace the card. Replace with a new card.





For both JPEG and RAW images, the file name will start with "IMG_". The extension will be ".JPG" for JPEG images and ".CR2" for RAW images.

MENU Auto Image Rotation





Vertical images are rotated automatically so they are displayed vertically on the camera's LCD monitor and personal computer instead of horizontally. The setting of this feature can be changed.



Under the **[F]** tab, select **[Auto rotate]**, then press **<SET>**. Follow the steps below to select the desired setting, then press **<SET>**.

- **[On  : The vertical image is automatically rotated on both the camera's LCD monitor and on the personal computer.**
- **[On  : The vertical image is automatically rotated only on the personal computer.**
- **[Off]** : The vertical image is not automatically rotated at all.

? FAQ

- **The vertical image is not rotated during the image review immediately after it is captured.**
Press the **<▶>** button and the image playback will display the rotated image.
- **[On   is set, but the image does not rotate during playback. Auto rotate will not work with vertical images captured while **[Auto rotate]** was set to **[Off]**. Also, if the vertical image is taken while the camera is pointed up or down, the image might not rotate for playback. In such a case, see "Rotating the Image" on page 126.**
- **On the camera's LCD monitor, I want to rotate an image captured when [On  had been set.**
Set **[On  , then playback the image. It will be rotated.**
- **The vertical image does not rotate on the personal computer screen.**
The software used is not compatible with image rotation. Use the camera's bundled software instead.

DISP. Checking Camera Function Settings

While the menu is displayed, press the <DISP.> button to display the camera's current settings.

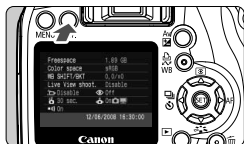

- While the menu is displayed, press the <DISP.> button to display the settings.
- Press the <DISP.> button again to return to the menu.
- Press the shutter button halfway to return to the shooting settings display.

Settings Display

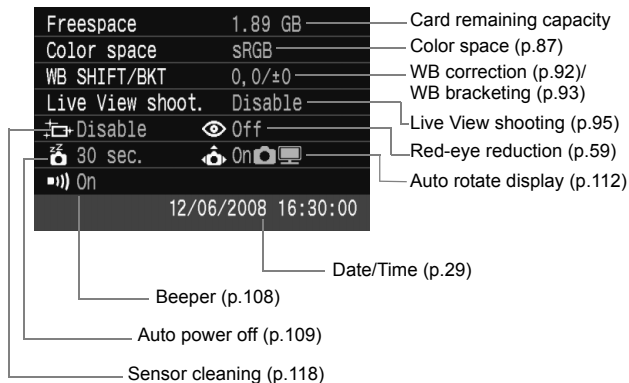

MENU Reverting the Camera to the Default Settings★

This is for reverting all the camera's shooting settings and Custom Functions to the default settings. This works in the <P> and other Creative Zone modes.

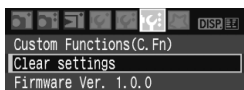

1 Select [Clear settings].

- Under the [Fn] tab, select [Clear settings], then press <SET>.

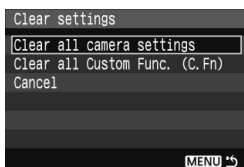

2 Select the desired setting.

- To revert the shooting settings to the default, select [Clear all camera settings], then press <SET>.
- To revert the Custom Functions to the default settings, select [Clear all Custom Func. (C.Fn)], then press <SET>.

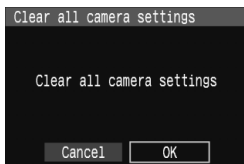

3 Select [OK].

- Select [OK], then press <SET> to clear the camera settings.
- ▶ When [Clear all camera settings] is set, the camera will be reset as shown in the table below.

Shooting Settings

AF mode	One-Shot AF
AF point selection	Automatic selection
Metering mode	(Evaluative metering)
Drive mode	<input type="checkbox"/> (Single shooting)
Exposure compensation	0 (Zero)
AEB	Canceled
Flash exposure compensation	0 (Zero)
Live View shooting	Disable

Image Settings

Quality	L
ISO speed	Auto
File numbering	Continuous
Color space	sRGB
White balance	(Auto WB)
WB correction	Canceled
WB bracketing	Canceled
Picture Style	Standard

* The white balance data (p.90) obtained from the custom white balance and the Dust Delete Data (p.119) will be erased.

MENU Setting the LCD Monitor Off/On

You can enable or disable the LCD monitor's shooting settings display (p.42) from turning on when the shutter button is pressed halfway.



Under the [IY] tab, select [LCD off/on btn], then press <SET>. Select one of the settings below, then press <SET>.

- **[Shutter btn.]**: The display turns off when you press the shutter button halfway, and reappears when you let go of the shutter button.
- **[Shutter/DISP]**: The display turns off when you press the shutter button halfway, and remains off after you let go of the shutter button. To turn on the display, press the <DISP.> button or <SET>.
- **[Remains on]**: The display does not turn off when you press the shutter button halfway. To turn off the display, press the <DISP.> button or <SET>.

MENU Changing the Shooting Settings Screen Color

You can change the background color of the shooting settings screen.

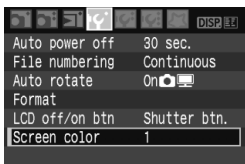

Select [Screen color].

- Under the [IY] tab, select [Screen color], then press <SET>.
- Select the desired color, then press <SET>.
- When you exit the menu, the selected color will be displayed for the shooting settings screen.

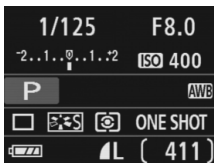
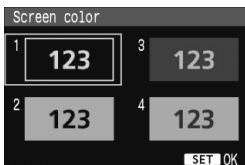

MENU Flash Control★

The built-in flash and external Speedlite can also be set with the menu. The menu for the external Speedlite will be applicable only to **EX-series Speedlites whose functions can be set with the camera.**

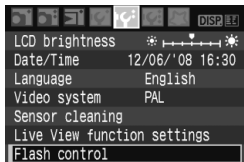

Select [Flash control].

- Under the [Fv] tab, select [Flash control], then press <SET>.
- ▶ The flash control screen will appear.

[Flash firing]

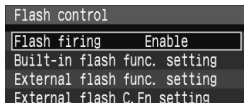

- Normally, set this to [Enable].
- If [Disable] is set, both the built-in flash and external Speedlite will not fire. This is good when you only want to use the AF-assist beam.

[Built-in flash func. setting]

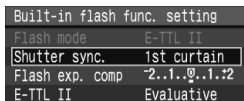

- [Flash mode] cannot be selected.
- [Flash exp. comp] can be set as explained on page 79.
- Set [E-TTL II] as explained on the next page.

● Shutter sync.

Normally, set this to [1st curtain] so that the flash fires immediately after the exposure starts.

If [2nd curtain] is set, the flash will fire right before the exposure ends. When this is combined with a slow sync speed, you can create a trail of light such as from car headlights at night. With 2nd curtain sync, two flashes will be fired. Once when you press the shutter button completely, and once immediately before the exposure ends.

● E-TTL II

For normal flash exposures, set it to **[Evaluative]**.

If **[Average]** is set, the flash exposure will be averaged for the entire metered scene as with an external metering flash. Flash exposure compensation may be necessary depending on the scene, so this is for advanced users.

Setting the External Speedlites

Select either **[External flash func. setting]** or **[External flash C.Fn setting]**. For details on which external Speedlite settings the camera can set, see the compatible EX-series (such as the 580EX II) Speedlite's instruction manual.

Attach the Speedlite to the camera and turn on the Speedlite.

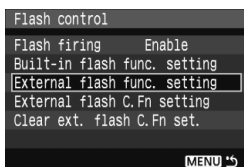

1 Select either **[External flash func. setting]** or **[External flash C.Fn setting]**.

- Select either one, then press < **SET** >.
- Settings which cannot be set will be dimmed.

External flash func. setting

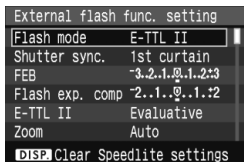

2 Set the external flash function settings.

- Select a flash function and set it as desired. The procedure is the same as setting a menu function.
- On the flash function settings screen, the settable items or current settings displayed differ depending on the current flash mode settings or flash Custom Function settings.
- If you press the < **DISP.** > button to clear the Speedlite settings, both the external Speedlite and built-in flash settings will be cleared.

External flash C.Fn setting

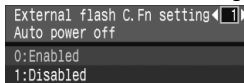

MENU Automatic Sensor Cleaning

Whenever you set the power switch to <ON> or <OFF>, the Self Cleaning Sensor Unit operates to automatically shake off the dust on the front of the sensor. Normally, you need not be aware of this operation. However, you can execute the sensor cleaning at anytime as well as disable it.

Cleaning the Sensor Now

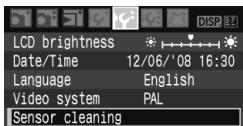

1 Select [Sensor cleaning].

- Under the [F2] tab, select [Sensor cleaning], then press <SET>.

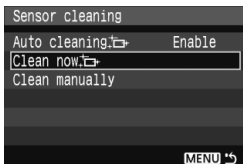

2 Select [Clean now].

- Select [Clean now], then press <SET>.
- Select [OK], then press <SET>.
- ▶ The screen will indicate that the sensor is being cleaned. Although there will be a shutter sound, a picture is not taken.

- For best results, do the sensor cleaning while the camera bottom is placed on a table or other surface at a perpendicular angle.
- Even if you repeat the sensor cleaning, the result will not improve that much. Right after the sensor cleaning is finished, the [Clean now] option will remain disabled temporarily.

Disabling Automatic Sensor Cleaning

- In step 2, select [Auto cleaning] and set it to [Disable].
- ▶ The sensor cleaning will no longer be executed when you set the power switch to <ON> or <OFF>.

MENU Appending Dust Delete Data★

Normally, the Self Cleaning Sensor Unit will eliminate most of the dust visible on captured images. However, in case visible dust still remains, you can append the Dust Delete Data to the image to later erase the dust spots. The Dust Delete Data is used by Digital Photo Professional (provided software) to erase the dust spots automatically.

Preparation

- Get a solid-white object (paper, etc.).
- Set the lens focal length to 50mm or longer.
- Set the lens focus mode switch to <MF> and set the focus to infinity (∞). If the lens has no distance scale, look at the front of the lens and turn the focusing ring clockwise all the way.

Obtain the Dust Delete Data



1 Select [Dust Delete Data].

- Under the [D:] tab, select [Dust Delete Data], then press <SET>.

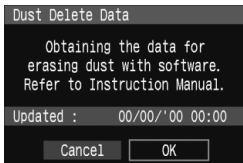

2 Select [OK].

- Select [OK] and press <SET>. The automatic self-cleaning of the sensor will be performed, then a message screen will appear. Although there will be a shutter sound, a picture is not taken.

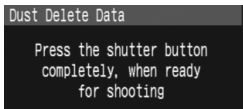
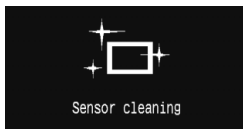

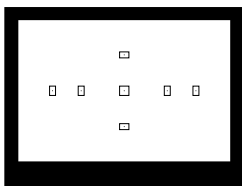

3 Photograph a solid-white object.

- At a distance of 20 cm - 30 cm / 0.7 ft. - 1.0 ft., fill the viewfinder with a patternless, solid-white object and take a picture.
- ▶ The picture will be taken in the aperture-priority AE mode with an aperture of f/22.
- Since the image will not be saved, the data can still be obtained even if there is no card in the camera.
- ▶ When the picture is taken, the camera will start obtaining the Dust Delete Data. When the Dust Delete Data is obtained, a message will appear. Select **[OK]**, and the menu will reappear.
- If the data was not obtained successfully, a message to that effect will appear. Follow the "Preparation" procedure on the preceding page, then select **[OK]**. Take the picture again.

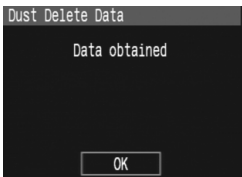

About the Dust Delete Data

After the Dust Delete Data is obtained, it is appended to all the JPEG and RAW images captured thereafter. Before an important shoot, you should update the Dust Delete Data by obtaining it again.

For erasing dust spots automatically with the bundled software, see the Software Instruction Manual in the CD-ROM.

The Dust Delete Data appended to the image is so small that it hardly affects the image file size.

! Be sure to use a solid-white object such as a white piece of paper. If the paper has any pattern or design, it may be recognized as dust data and affect the accuracy of the dust deletion with the software.

MENU Manual Sensor Cleaning★

Dust which could not be removed by the automatic sensor cleaning can be removed manually with a blower, etc.

The surface of the image sensor is extremely delicate. If the sensor needs to be cleaned directly, having it done by a Canon Service Center is recommended.

Before cleaning the sensor, detach the lens from the camera.

1 Select [Sensor cleaning].

- Under the [I/F] tab, select [Sensor cleaning], then press <SET>.

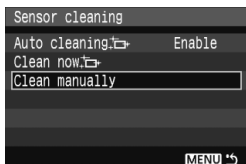

2 Select [Clean manually].

- Select [Clean manually], then press <SET>.



3 Select [OK].

- Select [OK], then press <SET>.
- ▶ In a moment, the mirror will lockup and the shutter will open.

4 End the cleaning.

- Set the power switch to <OFF>.



- For the power source, using the AC Adapter Kit ACK-E5 (sold separately) is recommended.
- If you use the battery, make sure it is fully recharged. If a battery grip with size-AA batteries is attached, manual sensor cleaning will not be possible.



- **While cleaning the sensor, never do any of the following. If the power is cut off, the shutter will close and the shutter curtains and image sensor might get damaged.**
 - **Setting the power switch to <OFF>.**
 - **Opening the battery compartment cover.**
 - **Opening the card slot cover.**
- The surface of the image sensor is extremely delicate. Clean the sensor with care.
- Use a plain blower without any brush attached. A brush can scratch the sensor.
- Do not insert the blower tip inside the camera beyond the lens mount. If the power is turned off, the shutter will close and the shutter curtains or reflex mirror might get damaged.
- Never use canned air or gas to clean the sensor. The blowing force can damage the sensor or the spray gas can freeze on the sensor.

7

Image Playback

This chapter explains features related to viewing images. Learn more about image playback as discussed in chapter 2 “Basic Shooting and Image Playback” and how to view images on a TV set. You can also erase images.

About images taken with another camera:

The camera might not be able to properly display images captured with a different camera or edited with a personal computer or whose file name was changed.

▶ Searching for Images Quickly

☒ Display Multiple Images on One Screen (Index display)

Search for images quickly with the index display showing four or nine images on one screen.



1 Turn on the index display.

- During image playback, press the <☒·🔍> button.
- ▶ The 4-image index display will appear. The currently-selected image will be highlighted in a blue frame.
- Press the <☒·🔍> button again to switch to the 9-image index display.



2 Select the image.

- Turn the <🔧> dial to select an adjacent image.
- Press the <⬅️➡️> key to move the blue frame to select another image.
- Press the <🔍> button to display the selected image at full view.
(9 images → 4 images → 1 image)

Jump through Images (Jump display)

When the card contains many images, you can browse through them by 10 or 100 images at a time. Also, if the images were shot on different days, you can browse through them by date. This browsing technique is called jump.



Jump method

Image location

1 Select the jump method.

- In the single image display mode, press the <▲> key.
- ▶ On the bottom right, the jump method and current image location are indicated.
- Press the <▲▼> key to select the jump method among [1 image/10 images/100 images/Date], then press <SET>.

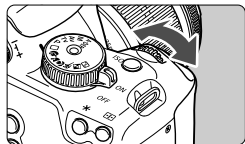

2 Browse by jumping.

- During image playback, turn the <⚙> dial.
- ▶ The jump display will proceed according to the selected jump method.
- For single image browsing, press the <◀▶> key.

 Jump is not possible with the index display.

Magnified View



Magnified area

Magnify the image.

- During image playback, press the $\langle \text{Q} \rangle$ button to magnify the image.
- If you keep pressing the $\langle \text{Q} \rangle$ button, you can magnify the image up to 10x.
- Use the $\langle \blacklozenge \rangle$ keys to scroll around the magnified image.
- Press the $\langle \text{Q} \rangle$ button to reduce the magnification. To exit the magnified view, press the $\langle \text{▶} \rangle$ button. The single-image view will return.

- You can turn the $\langle \text{Sun} \rangle$ dial to view another image with the magnification maintained.
- Magnified view is not possible during the image review immediately after the image is taken.

Rotating the Image





1 Select [Rotate].

- Under the $\langle \text{▶} \rangle$ tab, select [Rotate], then press $\langle \text{SET} \rangle$.



2 Select the image and rotate it.

- Press the $\langle \blacktriangleleft \blacktriangleright \rangle$ key to select the image to be rotated, then press $\langle \text{SET} \rangle$.
- Each time you press $\langle \text{SET} \rangle$, the image will rotate clockwise as follows: $90^\circ \rightarrow 270^\circ \rightarrow 0^\circ$
- To rotate another image, repeat step 2.
- To exit the image rotate and return to the menu, press the $\langle \text{MENU} \rangle$ button.

- If the rotated image is not displayed in the rotated orientation during image playback, set the $\langle \text{IF} \rangle$ Auto rotate menu to [On  ].

MENU Auto Playback

You can playback the images in the card as an automatic slide show. Each image will be displayed for about 4 sec.



1 Select [Auto play].

- Under the [] tab, select [**Auto play**], then press <SET>.
- ▶ The auto play screen will appear.

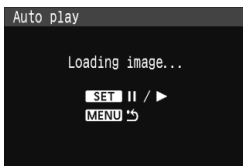

2 Start the auto play.

- ▶ After [**Loading image...**] is displayed for a few seconds, auto play will start.
- To pause the auto play, press <SET>.
- During pause, [II] will be displayed on the upper left of the image. Press <SET> again to resume the auto play.



3 Stop the auto play.

- To stop the auto play and return to the menu, press the <MENU> button.



- During auto play, you can press the <DISP.> button to change the display format.
- During pause, you can press the <◀▶> key to view another image.
- During auto play, auto power off will not work.
- The display time may vary depending on the image.

Viewing the Images on TV

With the video cable provided with the camera, you can connect the camera to a TV set and view images on the TV screen. Turn off the camera and the television before connecting them.

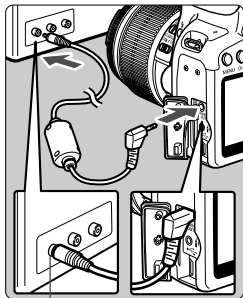

Video IN terminal

1 Connect the camera to the TV.

- Open the camera's terminal cover.
- Use the video cable (provided) to connect the camera's <VIDEO OUT> video terminal to the TV monitor's VIDEO IN terminal.
- Insert the cable plug all the way in.

2 Turn on the TV and switch the TV's line input to VIDEO IN.

3 Set the camera's power switch to <ON>.

4 Press the <▶> button.

- ▶ The image will appear on the TV screen. (Nothing will be displayed on the camera's LCD monitor.)
- After you finish, set the camera's power switch to <OFF>, turn off the TV, then disconnect the video cable.



- If the video system format does not match the TV's, the images will not be displayed properly. Set the proper video system format with [**Video system**].
- Do not use any video cable other than the one provided. Images might not be displayed if you use a different video cable.
- Depending on the TV monitor, part of the image might be cut off.

Protecting Images

Protecting the image prevents it from being erased accidentally.

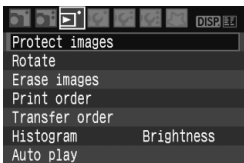





Image protect icon



1 Select [Protect images].

- Under the [] tab, select [Protect images], then press <SET>.
- ▶ The protect setting screen will appear.

2 Select the image and protect it.

- Press the <◀▶> key to select the image to be protected, then press <SET>.
- ▶ When an image is protected, the <> icon will appear on the screen.
- To cancel the image protection, press <SET> again. The <> icon will disappear.
- To protect another image, repeat step 2.
- To exit the image protection, press the <MENU> button. The menu will reappear.

 **If you format the card (p.40), the protected images will also be erased.**

- Once an image is protected, it cannot be erased by the camera's erase function. To erase a protected image, you must first cancel the protection.
- If you erase all the images (p.130), only the protected images will remain. This is convenient when you want to erase unnecessary images all at once.

Erasing Images

You can either select and erase images one by one or erase them in one batch. Protected images (p.129) will not be erased.

- 1 **Once an image is erased, it cannot be recovered. Make sure you no longer need the image before erasing it. To prevent important images from being erased accidentally, protect it. Erasing a **RAW** + **L** image will erase both the RAW and JPEG images.**

Erasing a Single Image



1 **Playback the image to be erased.**

2 **Press the  button.**



- The erase menu will appear at the bottom of the screen.

3 **Erase the image.**

- ▶ Select [**Erase**], then press **<SET>**. The image displayed will be erased.



MENU Checkmarking Images to be Erased in a Batch

By checkmarking the images to be erased, you can erase multiple images at one time. On the [ **Erase images**] menu, select [**Select and erase images**]. With the **<▲▼>** key, checkmark  the images to be erased. Then press the  button.

MENU Erasing All Images in the Card

When the [ **Erase images**] menu is set to [**All images on card**], all the images in the card will be erased.

DISP. Shooting Information Display

When you press the <DISP.> button during single-image playback, you can switch to the shooting information display. The most detailed shooting information is shown below.

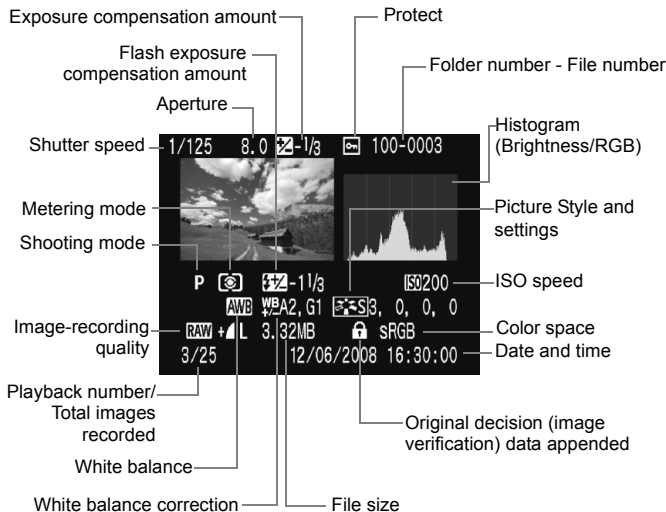

* With **RAW + L** images, the **L** file size is displayed.

● About the Highlight Alert

When the shooting information is displayed, the overexposed highlight areas will blink. To obtain more image detail in the overexposed areas, set the exposure compensation to a negative amount and shoot again.

● About the Histogram

The brightness histogram display shows the exposure level distribution, overall brightness, and gradation. And the RGB histogram display is for checking the color saturation and gradation. The display can be switched with the [ Histogram] menu.

[Brightness] Display

This histogram is a graph showing the distribution of the image's brightness level. The horizontal axis indicates the brightness level (darker on the left and brighter on the right), while the vertical axis indicates how many pixels exist for each brightness level. The more pixels there are toward the left, the darker the image. And the more pixels there are toward the right, the brighter the image. If there are too many pixels on the left, the shadow detail will be lost. And if there are too many pixels on the right, the highlight detail will be lost. The gradation in-between will be reproduced. By checking the image and its brightness histogram, you can see the exposure level inclination and the overall tone reproduction condition.

Sample Histograms



Dark image



Normal brightness



Bright image

[RGB] Display

This histogram is a graph showing the distribution of the image's brightness level of each primary color (RGB or red, green, and blue). The horizontal axis indicates the color's brightness level (darker on the left and brighter on the right), while the vertical axis indicates how many pixels exist for each color brightness level. The more pixels there are toward the left, the darker and less prominent the color. And the more pixels there are toward the right, the brighter and denser the color. If there are too many pixels on the left, the respective color information will be lacking. And if there are too many pixels on the right, the color will be too saturated with no detail. By checking the image's RGB histogram, you can see the color's saturation and gradation condition and white balance inclination.

8

Printing Images and Transferring Images to a Computer

- **Printing** (p.134)

You can connect the camera directly to a printer and print out the images in the card. The camera is compatible with “PictBridge” which is the standard for direct printing. The Web site below gives more information on using your Canon camera with various printers, such as which paper types to use.

<http://canon.com/pictbridge/>

- **Digital Print Order Format (DPOF)** (p.143)

DPOF (Digital Print Order Format) enables you to print images recorded in the card according to your printing instructions such as the image selection, quantity to print, etc. You can print multiple images in one batch or give the print order to a photofinisher.

- **Transferring Images to a Personal Computer** (p.147)

By connecting the camera to a personal computer, you can transfer images from the camera's card by operating the camera.

Preparing to Print

You do the direct printing procedure entirely with your camera while you look at the LCD monitor.

Connecting the Camera to a Printer

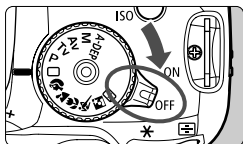

1 Set the camera's power switch to <OFF>.

2 Set up the printer.

- For details, see the printer's instruction manual.

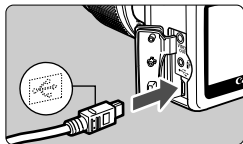

3 Connect the camera to the printer.

- Use the interface cable that came with the camera.
- When connecting the cable plug to the camera's <↔> terminal, the cable plug's <↔> icon must face the front side of the camera.
- To connect to the printer, refer to the printer's instruction manual.

4 Turn on the printer.

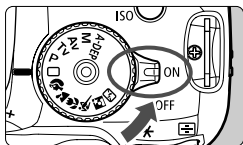

5 Set the camera's power switch to <ON>.

- ▶ Some printers may make a beeping sound.

PictBridge



6 Playback the image.

- Press the <▶> button.
- ▶ The image will appear, and the <📷> icon will appear on the upper left to indicate that the camera is connected to a printer.
- ▶ The <📷> button lamp will light in blue.



- RAW images are not compatible with direct printing.
- The camera cannot be used with printers compatible only with CP Direct or Bubble Jet Direct.
- When connecting the camera to the printer, do not use any cable other than the interface cable provided.
- If there is a long beeping sound in step 5, it indicates a problem with the printer. To find out what's wrong, do the following:
 1. Press the <▶> button to playback the image.
 2. Press <SET>.
 3. On the print setting screen, select **[Print]**.

The error message will be displayed on the LCD monitor. (p.142)



- If you use the battery to power the camera, make sure it is fully charged. With a fully charged battery, printing up to about 6 hours is possible.
- Before disconnecting the cable, turn off the camera and printer first. Hold the plug (not the cord) to pull out the cable.
- For direct printing, using AC Adapter Kit ACK-E5 (sold separately) to power the camera is recommended.

Printing

The screen display and setting options will differ depending on the printer. Some settings might not be available. For details, see the printer's instruction manual.

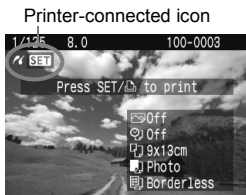

1 Select the image to be printed.

- Check that the <☞> icon is displayed on the upper left of the LCD monitor.
- Press the <◀▶> key to select the image to be printed.

2 Press <SET>.

- ▶ The print setting screen will appear.

Print setting screen

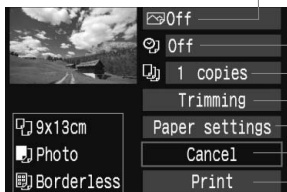

Sets the printing effects. (p.138)

Sets the date or file number imprinting to on or off.

Sets the quantity to be printed.

Sets the trimming. (p.141)

Sets the paper size, type, and layout.

Returns to step 1.

Starts the printing.

The paper size, type, and layout you have set will be displayed.

* Depending on the printer, settings such as the date and file number imprinting and trimming might not be available.



3 Select [Paper settings].

- Select [Paper settings], then press <SET>.
- ▶ The paper settings screen will appear.

Setting the Paper Size

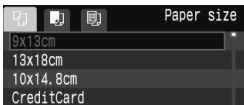

- Select the size of the paper loaded in the printer, then press **<SET>**.
- ▶ The paper type screen will appear.

Setting the Paper Type

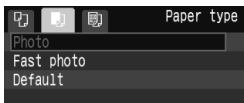

- Select the type of the paper loaded in the printer, then press **<SET>**.
- When using a Canon printer and Canon paper, read the printer's instruction manual to check what paper types can be used.
- ▶ The page layout screen will appear.

Setting the Page Layout



- Select the page layout, then press **<SET>**.
- ▶ The print setting screen will reappear.

Bordered	The print will have a white border along the edges.
Borderless	The print will have no white borders. If your printer cannot print borderless prints, the print will have borders.
Bordered [i]	The shooting information* will be imprinted on the border on 9x13cm and larger prints.
xx-up	Option to print 2, 4, 8, 9, 16, or 20 images on one sheet.
20-up [i] 35-up [i]	On A4 or Letter size paper, 20 or 35 thumbnails of the images ordered through DPOF (p.143) will be printed. • [20-up [i]] will have the shooting information* imprinted.
Default	The page layout will vary depending on the printer type or its settings.

* From the Exif data, the camera name, lens name, shooting mode, shutter speed, aperture, exposure compensation amount, ISO speed, white balance, etc., will be imprinted.

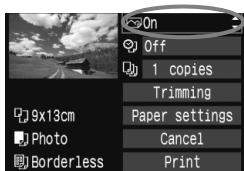

4 Set the printing effects.

- Set as necessary. If you need not set any printing effects, go to step 5.
- **The screen display may differ depending on the printer.**
- Select the option on the upper right, then press <SET>. Select the desired printing effect, then press <SET>.
- If the <DISP.> icon is displayed next to <DISP.>, you can also adjust the printing effect. (p.140)

Printing Effect	Description
Off	Same as the printing characteristics turned "On". No automatic correction will be performed.
On	The image will be printed according to the printer's standard colors. The image's Exif data is used to make automatic corrections.
Vivid	The image will be printed with higher saturation to produce more vivid blues and greens.
NR	The image noise is reduced before printing.
Face	Effective in backlit conditions which can make the subject's face look dark. The face will be brightened for printing.
Red-Eye1	Effective in flash images where the subject has red eye. The red eye is corrected before printing.
B/W B/W	Prints in black-and-white with true blacks.
B/W Cool tone	Prints in black-and-white with cool, bluish blacks.
B/W Warm tone	Prints in black-and-white with warm, yellowish blacks.
Natural	Prints the image in the actual colors and contrast. No automatic color adjustments will be applied.
Natural M	The printing characteristics are the same as the "Natural" setting. However, this setting enables finer printing adjustments than with "Natural."
Default	The printing will differ depending on the printer. For details, see the printer's instruction manual.

- * When you change the printing effects, it is reflected in the image displayed on the upper left. Note that the printed image might look slightly different from the displayed image which is only an approximation. This also applies to [Brightness] and [Adjust levels] on page 140.



5 Set the date and file number imprinting.

- Set as necessary.
- Select <Both>, then press <SET>.
- Set as desired, then press <SET>.

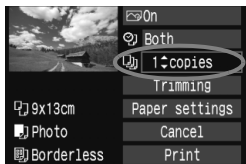

6 Set the number of copies.

- Set as necessary.
- Select <1 copies>, then press <SET>.
- Set the number of copies, then press <SET>.



7 Start printing.

- Select [Print], then press <SET>.
- ▶ The <Print> button's blue lamp will blink and the printing will start.



- To print another image with the same settings in easy printing, select the image and just press the <Print> button lit in blue. With easy printing, the number of copies will always be 1. Also, any trimming will not be applied.
- For details on trimming, see page 141.
- The [Default] setting for printing effects and other options are the printer's own default settings as set by the printer's manufacturer. See the printer's instruction manual to find out what the [Default] settings are.
- Depending on the image's file size and image-recording quality, it may take some time for the printing to start after you select [Print].
- To stop the printing, press <SET> while [Stop] is displayed, then select [OK].

Adjustment of Printing Effects

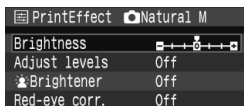
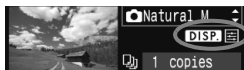

In step 4 on page 138, select the printing effect. When the <≡> icon is displayed next to <DISP.>, press the <DISP.> button. You can then adjust the printing effect. What can be adjusted or what is displayed will depend on the selection made in step 4.

● Brightness

The image brightness can be adjusted.

● Adjust levels

When you select [**Manual**], you can change the histogram's distribution and adjust the image's brightness and contrast.

With the adjust levels screen displayed, press the <DISP.> button to change the position of the <▶>. Press the <◀▶> key to freely adjust the shadow level (0 - 127) or highlight level (128 - 255).

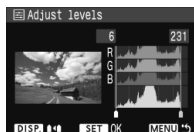

● Brightener

Effective in backlit conditions which can make the subject's face look dark. When [**On**] is set, the face will be brightened for printing.

● Red-eye corr.

Effective in flash images where the subject has red eye. When [**On**] is set, the red eye will be corrected for printing.

- The [**Brightener**] and [**Red-eye corr.**] effects will not show up on the screen.
- When you select [**Detail set.**], you can adjust the [**Contrast**], [**Saturation**], [**Color tone**], and [**Color balance**]. To adjust the [**Color balance**], use the <◀◆> keys. B is for blue, A is amber, M is magenta, and G is green. The color in the respective direction will be corrected.
- If you select [**Clear all**], all the printing effect settings will be reverted to the default.

Trimming the Image



You can crop the image and print only the trimmed portion as if the image was recomposed. **Do the trimming right before printing.** If you set the trimming and then set the print settings, you may have to set the trimming again.

1 On the print setting screen, select [Trimming].

2 Set the trimming frame size, position, and proportion.

- The image area within the trimming frame will be printed. The trimming frame's vertical-to-horizontal proportion can be changed with [Paper settings].

Changing the trimming frame size

When you press the <Q> or <Q> button, the size of the trimming frame will change. The smaller the trimming frame, the larger the image magnification will be for the printing.

Moving the trimming frame

Press the <D> keys to move the frame over the image vertically or horizontally. Move the trimming frame until it covers the desired image area or composition.

Rotating the frame

Each time you press the <DISP.> button, the trimming frame will toggle between the vertical and horizontal orientations. This enables you to create a vertical-oriented print from a horizontal image.

3 Press <SET> to exit the trimming.

- ▶ The print setting screen will reappear.
- You can check the trimmed image area on the upper left of the print setting screen.

- Depending on the printer, the trimmed image area might not be printed as you specified.
- The smaller you make the trimming frame, the grainier the picture will look on the print.
- While trimming the image, look at the camera's LCD monitor. If you look at the image on a TV screen, the trimming frame might not be displayed accurately.



Handling Printer Errors

If you resolve a printer error (no ink, no paper, etc.) and select [**Continue**] to resume printing but it does not resume, operate the buttons on the printer to resume printing. For details, see the printer's instruction manual.

Error Messages

If a problem occurs during printing, an error message will appear on the camera's LCD monitor. Press <  > to stop printing. After fixing the problem, resume printing. For details on how to fix a printing problem, refer to the printer's instruction manual.

Paper error

Check whether the paper is properly loaded in the printer.

Ink error

Check the printer's ink level, and check the waste ink tank.

Hardware error

Check for any printer problems other than paper and ink problems.

File error

The selected image cannot be printed via PictBridge. Images taken with a different camera or images edited with a computer might not be printable.

Digital Print Order Format (DPOF)

Set the print type, date imprinting, and file No. imprinting. The print settings will be applied to all print-ordered images. (They cannot be set individually for each image.)

Setting the Printing Options



1 Select [Print order].

- ▶ Under the [DISP.] tab, select [Print order], then press <SET>.

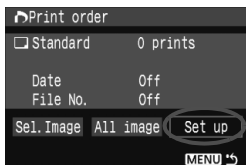

2 Select [Set up].

- Select [Set up], then press <SET>.

3 Set the options as desired.

- Set the [Print type], [Date], and [File No.].
- Select the option, then press <SET>.
- Select the desired setting, then press <SET>.

[Print type]

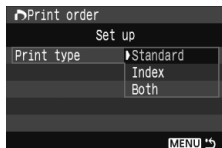



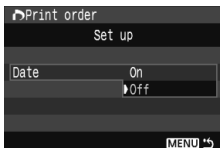

[Date]

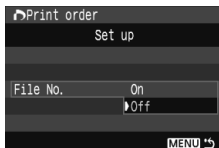

[File No.]



Print type		Standard	Prints one image on one sheet.
		Index	Multiple, thumbnail images are printed on one sheet.
	 	Both	Prints both the standard and index prints.
Date	On	[On] imprints the recorded date on the print.	
	Off		
File No.	On	[On] imprints the file No. on the print.	
	Off		

4 Exit the setting.

- Press the <MENU> button.
- ▶ The print order screen will reappear.
- Next, select [**Sel.Image**] or [**All image**] to order the images to be printed.



- 
- Even if [**Date**] and [**File No.**] are set to [**On**], the date or file No. might not be imprinted depending on the print type setting and printer model.
 - When printing with DPOF, you must use the card whose print order specifications have been set. It will not work if you just extract images from the card and try to print them.
 - Certain DPOF-compatible printers and photofinishers might not be able to print the images as you specified. If this happens with your printer, refer to the printer's instruction manual. Or check with your photofinisher about compatibility when ordering prints.
 - Do not insert into the camera a card whose print order was set by a different camera and then try to specify a print order. The print order may not work or may be overwritten. Also, depending on the image type, the print order may not be possible.

- 
- Print ordering will not work with RAW images.
 - With [**Index**] prints, both the [**Date**] and [**File No.**] cannot be set to [**On**] at the same time.

Print Ordering

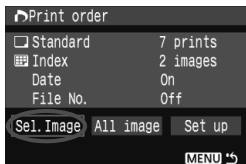
● Sel.Image



Select and order images one by one. Press the <  > button to display the three-image view. To return to the single-image display, press the <  > button. After completing the print order, press the < MENU > button to save the print order to the card.



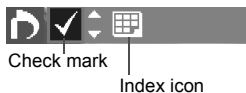

[Standard] [Both]

Press the <  > key to set the number of copies to be printed for the displayed image.



[Index]

Press the <  > key to checkmark the box <  > and the image will be included in the index print.

● All image

If you select [**Mark all on card**], one copy of all the images in the card will be set for printing. If you select [**Clear all on card**], the print order will be cleared for all the images in the card.



- Note that RAW images will not be included in the print order even if you set "All image."
- When using a PictBridge printer, print no more than 400 images for one print order. If you specify more than this, all the images might not be printed.

Direct Printing with DPOF

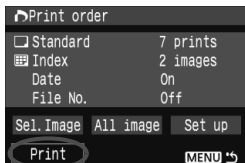

With a PictBridge printer, you can easily print images with DPOF.

1 Prepare to print.

- See page 134.
Follow the “Connecting the Camera to a Printer” procedure up to step 5.

2 Under the [] tab, select [Print order].

3 Select [Print].

- [Print] will be displayed only if the camera is connected to the printer and printing is possible.

4 Set the [Paper settings]. (p.136)

- Set the printing effects (p.138) if necessary.

5 Select [OK].

- Before printing, be sure to set the paper size.
- Certain printers cannot imprint the file No.
- If [Bordered] is set, the date might be imprinted on the border, depending on the printer.
- Depending on the printer, the date might look light if it is imprinted on a bright background or on the border.

- Under [Adjust levels], [Manual] cannot be selected.
- If you stopped the printing and want to resume printing the remaining images, select [Resume]. Note that printing will not resume if you stop the printing and any of the following occurs:
 - Before resuming, you changed the print order or erased any images selected for the print order. For index printing, you changed the paper settings before resuming the printing. Or the card's remaining capacity was low when the printing was stopped.
- If a problem occurs during printing, see page 142.

Transferring Images to a Personal Computer ■

By connecting the camera to a personal computer, you can transfer images from the camera's card by operating the camera. This is called direct image transfer.

- 1 **Before connecting the camera to the personal computer, be sure to install the bundled software (EOS DIGITAL Solution Disk/CD-ROM) in the personal computer.** For instructions on how to install the software, see "CD-ROM Guide."

Preparation for Image Transfer

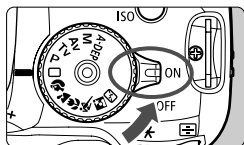
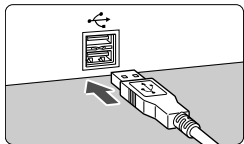
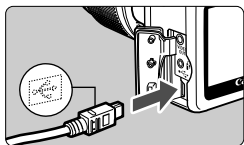

1 Connect the camera to the personal computer.

- Turn off the camera's power switch before connecting it.
- Use the interface cable that came with the camera.
- When connecting the cable plug to the camera's <⇄> terminal, the cable plug's <⇄> icon must face the front side of the camera.
- To the personal computer's USB port, connect the plug on other end of the cable.

2 Set the camera's power switch to <ON>.

- When the program selection screen appears on the personal computer, select **[EOS Utility]**.
When the camera model selection screen appears, select your camera's model.
- ▶ The **[EOS Utility]** screen will appear on the computer, and the direct image transfer screen will appear on the camera's LCD monitor.

⚠ Shooting will be disabled while the direct transfer screen is displayed.

- 📄 ● If the **[EOS Utility]** screen does not appear, see Software Instruction Manual in the CD-ROM.
- Before disconnecting the cable, turn off the camera. Pull out the cable by grasping the plug (instead of the cord).

Transferring Images to a Personal Computer

The images sent to the personal computer will be saved in the **[My Pictures]** folder or **[Pictures]** folder in subfolders organized according to shooting date.

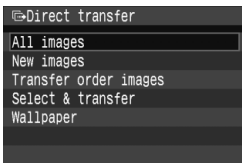

Transfer all the images in the card to the personal computer.

- Select **[All images]**, then press the <📷➡> button.
- ▶ The <📷➡> button's blue lamp will blink and the image transfer will start.
- ▶ When the image transfer is completed, the lamp will stay on.

Options other than **[All images]** are explained below. To start the image transfer, press the <📷➡> button.

● **New images**

Images which have not yet been transferred to the personal computer will be selected by the camera automatically and transferred.

● **Transfer order images**

You select the images and they are transferred to the personal computer in a batch. To select the images, follow the instructions on the next page.

● **Select & transfer**



Press the <◀▶> key to select images one by one to be transferred to the personal computer. To exit, press the <MENU> button.

● **Wallpaper**

The image you select and transfer will appear as the personal computer's wallpaper. To exit, press the <MENU> button.



- If you press <SET> instead of the <📁➡> button, the confirmation dialog will appear. Select [OK], then press <SET> to start the transfer.
- RAW images cannot be transferred as wallpaper.

MENU **Selecting the Images to be Transferred**

You select the image to be transferred to the personal computer one by one.



1

Select [Transfer order].

- Under the [▶] tab, select [Transfer order], then press <SET>.
- ▶ The transfer order screen will appear.

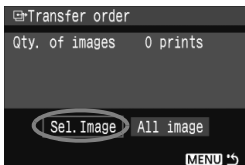

2

Select [Sel. Image].

- Select [Sel. Image], then press <SET>.
- ▶ An image will appear.



3 Select the image to be transferred.

- Press the <◀▶> key to select an image, then press the <▲▼> key to place a checkmark <✓> on the upper left.
- Repeat this step for all the images you want to transfer. You can select up to 998 images to be transferred.
- Press the <MENU> button twice to save the image selections to the card. The menu will then reappear.

About [All image]

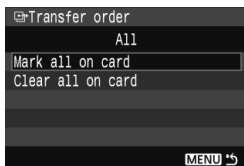

In step 2, if you select [**All image**], the screen on the left will appear. If you then select [**Mark all on card**] and press <SET>, up to 998 images will be transferred in one batch.

If you select [**Clear all on card**] and press <SET>, all your image selections for transfer will be canceled.

⚠ Do not put into the camera any images whose transfer order was set by a different camera and then try to specify another transfer order. The images in the transfer order might all be overwritten. Also, depending on the image type, the transfer order may not be possible.

- If a **RAW+L** image is selected for transfer, it will be counted as one image even though both the RAW and JPEG images will be transferred to the personal computer.
- In step 3, press the <☒Ⓞ> button to see a three-image display. To return to the single-image display, press the <Ⓞ> button.
- If you want to transfer more than 999 images in one batch, select [**All image**] on the direct transfer screen. (p.148)

9

Customizing the Camera

You can customize various camera features to suit your picture-taking preferences. You can do it with Custom Functions. Custom Functions can be set and used only in Creative Zone modes.

MENU Setting Custom Functions ★

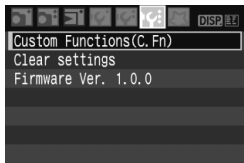

- 1 **Select [Custom Functions (C.Fn)].**
 - Under the [**MF**] tab, select [**Custom Functions (C.Fn)**], then press <SET>.

Custom Function No.

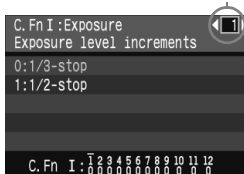

- 2 **Select the Custom Function No.**
 - Press the <◀▶> key to select the number of the Custom Function to be set, then press <SET>.

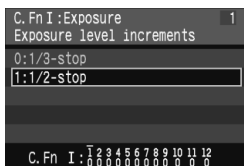

- 3 **Change the setting as desired.**
 - Press the <▲▼> key to select the desired setting (number), then press <SET>.
 - Repeat steps 2 and 3 if you want to set other Custom Functions.
 - At the bottom of the screen, the current Custom Function settings are indicated below the respective numbers.

- 4 **Exit the setting.**
 - Press the <MENU> button to return to the menu.

Clearing All Custom Functions

On the [**MF**: **Clear settings**] menu, select [**Clear all Custom Func. (C.Fn)**] to clear all the Custom Function settings. (p.114)

Custom Functions

C.Fn I: Exposure

1	Exposure level increments	p.154
2	Flash sync. speed in Av mode	

C.Fn II: Image

3	Long exposure noise reduction	p.155
4	High ISO speed noise reduction	
5	Auto Lighting Optimizer	p.156

C.Fn III: Auto focus/Drive

6	AF-assist beam firing	p.157
7	AF during Live View shooting	
8	Mirror lockup	

C.Fn IV: Operation/Others

9	Shutter/AE lock button	p.158
10	SET button when shooting	
11	LCD display when power ON	p.159
12	Add original decision data	



The Custom Functions whose numbers are shaded do not function during Live View shooting. (Settings are disabled.) If C.Fn-7-1/2 has been set and you want to use AE lock, set C.Fn-9-1.

MENU Custom Function Settings [★]

Custom Functions are organized into four groups based on the function type: C.Fn I: Exposure, C.Fn II: Image, C.Fn III: Auto focus/Drive, C.Fn IV: Operation/Others.

C.Fn I: Exposure

C.Fn-1 Exposure level increments

0: 1/3-stop

1: 1/2-stop

Sets 1/2-stop increments for the shutter speed, aperture, exposure compensation, AEB, etc. Effective when you prefer to control the exposure in less fine increments than 1/3-stop increments.

 The exposure level will be displayed in the viewfinder and on the LCD monitor as shown below.

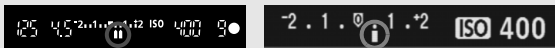

C.Fn-2 Flash sync. speed in Av (Aperture-priority AE) mode

0: Auto

The flash sync speed is set automatically within a range of 1/200 sec. to 30 sec. to suit the scene's brightness.

1: 1/200 sec. (fixed)

If you use the **<Av>** mode (aperture-priority AE) for flash photography, the shutter speed will be set to 1/200 sec. You need not worry about camera shake.

(However, night scene or dark backgrounds will look darker in this mode.)

C.Fn II: Image

C.Fn-3 Long exposure noise reduction

0: Off

1: Auto

For 1 sec. or longer exposures, noise reduction is performed automatically if noise typical of long exposures is detected. This [**Auto**] setting is effective in most cases.

2: On

Noise reduction is performed for all exposures 1 sec. or longer. The [**On**] setting may be effective for noise that cannot be detected or reduced with the [**Auto**] setting.



- After the picture is taken, the noise reduction process may take the same amount of time as the exposure. You cannot take another picture until the noise reduction process is completed.
- With setting 2, if a long exposure is made during Live View shooting, the LCD monitor will not display anything (no Live View image display) while noise reduction is applied.

C.Fn-4 High ISO speed noise reduction

0: Off

1: On

Reduces the noise generated in the image. Although noise reduction is applied at all ISO speeds, it is particularly effective at high ISO speeds. At low ISO speeds, the noise in the shadow areas is further reduced.



- With setting 1, continuous shooting and white balance bracketing cannot be used.

C.Fn-5 Auto Lighting Optimizer

0: Enable

If the image comes out too dark or the contrast is too low, the image brightness and contrast are corrected automatically. (Depending on the shooting conditions, image noise may increase.) This function will not work with manual exposures nor **RAW** and **RAW + L** images. In the Basic Zone modes, the Auto Lighting Optimizer will operate automatically.



1: Disable

C.Fn III: Auto focus/Drive

C.Fn-6 AF-assist beam firing

The AF-assist beam can be emitted by the camera's built-in flash or by the external, EOS-dedicated Speedlite.

0: Enable

1: Disable

AF-assist beam not emitted.

2: Only external flash emits

If an external, EOS-dedicated Speedlite is attached, it will emit the AF-assist beam when necessary. The camera's built-in flash will not emit the AF-assist beam.



If the external, EOS-dedicated Speedlite's **[AF-assist beam firing]** Custom Function is set to **[Disabled]**, the Speedlite will not emit the AF-assist beam even if the camera's C.Fn-6-0/2 is set.

C.Fn-7 AF during Live View shooting

When 1 or 2 is set, AF will be possible during Live View shooting. For details, see pages 102 - 106.

0: Disable

1: Quick mode (p.102)

2: Live mode (p.104)

C.Fn-8 Mirror lockup

0: Disable

1: Enable

Prevents camera vibrations caused by the reflex mirror action which can disturb shooting with super telephoto lenses or close-up (macro) shooting. See page 94 for the mirror lockup procedure.

C.Fn IV: Operation/Others

C.Fn-9 Shutter/AE lock button

0: AF/AE lock

1: AE lock/AF

Convenient when you want to focus and meter separately. Press the <✳> button to autofocus and press the shutter button halfway to attain AE lock.

2: AF/AF lock, no AE lock

In the AI Servo AF mode, you can press the <✳> button to stop the AF operation momentarily. This prevents the AF from being thrown off by any obstacle passing between the camera and subject. The exposure is set at the moment the picture is taken.

3: AE/AF, no AE lock

This is useful for subjects which keep moving and stopping repeatedly. In the AI Servo AF mode, you can press the <✳> button to start or stop the AI Servo AF operation. The exposure is set at the moment the picture is taken. Thus, the optimum focusing and exposure will always be achieved as you wait for the decisive moment.

C.Fn-10 SET button when shooting

You can assign a frequently-used function to <SET>. When the camera is ready to shoot, you can press <SET>.

0: LCD monitor On/Off

Gives the same function as the <DISP.> button.

1: Change quality

After pressing <SET>, look at the LCD monitor and press the <⬠> key to set the image-recording quality directly.

2: Flash exposure compensation

When you press <SET>, the flash exposure compensation screen appears so you can quickly change the setting.

3: Menu display

Gives the same function as the <MENU> button.

4: Disabled



If the [**Live View shoot.**] menu has been set to [**Enable**], the Live View shooting will override any setting from 1 to 4. When the camera is ready to shoot, pressing <SET> will show the Live View image instead.

C.Fn-11 LCD display when power ON

0: Display

When the power switch is turned on, the shooting settings will be displayed (p.42).

1: Retain power OFF status

If you pressed the <DISP.> button and turned off the camera while the LCD monitor was off, the shooting settings will not be displayed when you turn on the camera again. This helps to save battery power. The menu screens and image playback will still be displayed when used. If you pressed the <DISP.> button and turned off the camera while the LCD monitor was on, the shooting settings will be displayed when you turn on the camera again.

C.Fn-12 Add original decision data

0: Off

1: On

Data for verifying whether the image is original or not is appended to the image automatically. When the shooting information of an image appended with the verification data is displayed (p.131), the <🔒> icon will appear.

To verify whether the image is original, the Original Data Security Kit OSK-E3 (sold separately) is required.



The images are not compatible with the image encryption/decryption features of Original Data Security Kit OSK-E3.

MENU Registering My Menu ★

For faster access, you can register up to six menus and Custom Functions whose settings you change frequently.

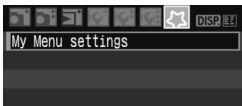

- 1 **Select [My Menu settings].**
 - Under the [] tab, select [**My Menu settings**], then press <SET>.

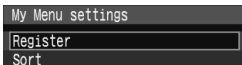

- 2 **Select [Register].**
 - Select [**Register**], then press <SET>.

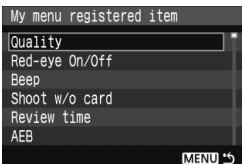

- 3 **Register the desired menus.**
 - Select a menu, then press <SET>.
 - When the confirmation dialog appears and you select [**OK**] and press <SET>, the menu will be registered.
 - Repeat this procedure to register up to six menus.
 - To return to the screen in step 2, press the <MENU> button.

My Menu settings

[**Sort**] and other settings displayed in step 2 are as follows:

- **Sort**

You can change the order of the registered menu items in My Menu. Select [**Sort**] and select the menu item whose order you want to change. Then press <SET>. With [] displayed, press the <▲▼> key to change the order, then press <SET>.
- **Display from My Menu**

When [**Enable**] is set, the [] tab will be displayed first when you display the menu screen.
- **Delete and Delete all items**

Deletes the registered menu items. [**Delete**] deletes one menu item at a time, and [**Delete all items**] deletes all menu items.

10

Reference

This chapter provides reference information for camera features, system accessories, etc. The back of this chapter also has an index to make it easier to look up things.

When Autofocus Fails

Autofocus can fail to achieve focus (the focus confirmation light <●> blinks) with certain subjects such as the following:

Subjects difficult to focus

- Low-contrast subjects
Example: Blue sky, solid-color walls, etc.
- Subjects in low light
- Extremely backlit or reflective subjects
Example: Car with a reflective body, etc.
- Near and far subjects covered by an AF point
Example: Animal in a cage, etc.
- Repetitive patterns
Example: Skyscraper windows, computer keyboards, etc.

In such cases, do one of the following:

- (1) With One-Shot AF, focus an object at the same distance as the subject and lock the focus before recomposing. (p.46)
- (2) Set the lens focus mode switch to <MF> and focus manually.



- If an Extender (sold separately) is attached and the maximum aperture of the lens is f/5.6 or smaller (larger f/number), AF will not be possible (except Live mode AF). For details, see the Extender's instruction manual.
- For the cases AF can fail to achieve focus with Live mode AF, see page 106.

Using a Household Power Outlet

With AC Adapter Kit ACK-E5 (sold separately), you can connect the camera to a household power outlet and not worry about the battery level.

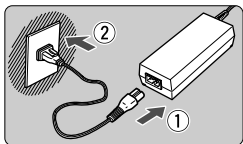

1 Connect the power cord.

- Connect the power cord as shown in the illustration.
- After using the camera, unplug the power plug from the power outlet.

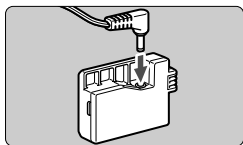

2 Connect the DC Coupler DR-E5.

- Connect the cord's plug to the DC Coupler DR-E5.

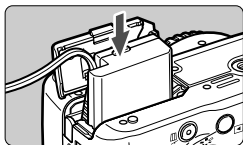

3 Insert the DC Coupler.

- Open the cover and insert the DC Coupler until it locks in place.

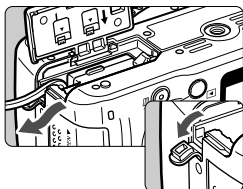

4 Push in the DC cord.

- Open the DC cord hole cover and install the cord as shown.
- Close the cover.





Do not connect or disconnect the power cord while the camera's power switch is set to <ON>.

Using the Remote Switch

Remote Switch RS-60E3 (Sold separately)

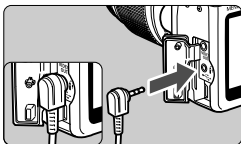
Remote switch with a 60 cm/2.0 feet cord for pressing the shutter button halfway or completely. It connects to the camera's remote control terminal.



 The camera is not compatible with Remote Controller RC-1 and RC-5 (both sold separately).

Using the Eyepiece Cover

If you take a picture without looking at the viewfinder, light entering the eyepiece can throw off the exposure. To prevent this, use the eyepiece cover (p.22) attached to the camera strap.

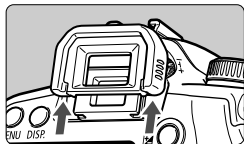

1 Remove the eyecup.

- Push the bottom of the eyecup upward.

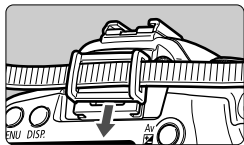

2 Attaching the eyepiece cover.

- Slide the eyepiece cover down into the eyepiece groove to attach it.

External Speedlites

EOS-dedicated, EX-series Speedlites

Basically operates like a built-in flash for easy operation.

When an EX-series Speedlite is attached to the camera, almost all the autoflash control is done by the camera. In other words, it is like a high-output flash attached externally in place of the built-in flash.

For detailed instructions, see the EX-series Speedlite's instruction manual. This camera is a Type-A camera that can use all the features of EX-series Speedlites.



Shoe-mount Speedlites



Macro Lites

 Only **[Flash exp. comp]** and **[E-TTL II]** can be settable for flash function settings (p.117) with an EX-series Speedlite not controllable by the camera. (For some EX-series Speedlites, **[Shutter sync.]** can also be settable.)

Canon Speedlites other than the EX-series

- **With an EZ/E/EG/ML/TL-series Speedlite set in the TTL or A-TTL autoflash mode, the flash can be fired at full output only.** Set the camera's shooting mode to <M> (manual exposure) or <Av> (aperture-priority AE) and shoot.
- When using a Speedlite which has manual flash mode, shoot in the manual flash mode.
- With an EX-series Speedlite set to TTL autoflash with the flash's Custom Function, the flash will fire at full output only.

Using Non-Canon Flash Units

Sync Speed

The camera can synchronize with compact, non-Canon flash units at 1/200 sec. or slower. Be sure to test the flash unit beforehand to make sure it synchronizes properly with the camera.

Cautions for Live View shooting

A non-Canon flash will not fire during Live View shooting.









- If the camera is used with a flash unit or flash accessory dedicated to another camera brand, the camera may not operate properly and malfunction may result.
- Do not attach a high-voltage flash unit on the camera's hot shoe. It might not work.

Menu Settings

Shooting 1 (Red)

page

Quality	 L /  L /  M /  M /  S /  S / RAW +  L / RAW	64
Red-eye On/Off	Off / On	59
Beep	On / Off	108
Shoot w/o card	On / Off	108
Review time	Off / 2 sec. / 4 sec. / 8 sec. / Hold	108





Shooting 2 (Red)

AEB	1/3-stop increments, ±2 stops	80
Flash exp comp	1/3-stop increments, ±2 stops	79
Custom WB	Manual setting of white balance	90
WB SHIFT/BKT	WB correction: White balance correction	92
	WB-BKT: White balance bracketing	93
Color space	sRGB / Adobe RGB	87
Picture Style	Standard / Portrait / Landscape / Neutral /	67
	Faithful / Monochrome / User Def. 1, 2, 3	82
		85
Dust Delete Data	Obtains data to be used to erase dust spots	119

Playback (Blue)



Protect images	Erase-protect image	129
Rotate	Rotate vertical image	126
Erase images	Erase image	130
Print order	Specifies images to be printed (DPOF)	143
Transfer order	Select images to be transferred to a personal computer	149
Histogram	Brightness / RGB	132
Auto play	Auto playback of images	127



- The [] Shooting 2, [] Set-up 3, and [] My Menu screens (tabs) are not displayed in Basic Zone modes.
- Shaded menu items are not displayed in Basic Zone modes.
- In Basic Zone modes, the RAW and RAW +  L recording quality modes are not displayed.

ⓘ Set-up 1 (Yellow)

page

Auto power off	30 sec. / 1min. / 2 min. / 4 min. / 8 min. / 15 min. / Off	109
File numbering	Continuous / Auto reset / Manual reset	110
Auto rotate	On  / On  / Off	112
Format	Initialize and erase data in the card	40
LCD off/on btn	Shutter btn. / Shutter/DISP / Remains on	115
Screen color	Select the background color	115

ⓘ Set-up 2 (Yellow)

LCD brightness	Seven brightness levels provided	109
Date/Time	Set the date (year, month, day) and time (hour, min., sec.)	29
Language	Select the interface language	30
Video system	NTSC / PAL	128
Sensor cleaning	Auto cleaning / Clean now	118
	Clean manually	121
Live View function settings	Live View shooting / Grid display / Metering timer	96
Flash control	Flash firing / Built-in flash function setting / External flash function setting / External flash C.Fn setting / Clear external flash C.Fn setting	116

ⓘ Set-up 3 (Yellow)

Custom Functions (C.Fn)	Customize the camera as desired	152
Clear settings	Clear all camera settings / Clear all Custom Func. (C.Fn)	114
Firmware Ver.	For updating the firmware	-

🔍 My Menu (Green)

My Menu settings	Register frequently-used menu items and Custom Functions	160
-------------------------	--	-----

Function Availability Table

● : Set automatically ○ : User selectable □ : Not selectable

Mode Dial		Basic Zone						Creative Zone					
		□	📷	📷	📷	📷	📷	P	Tv	Av	M	A-DEP	
Quality	JPEG	○	○	○	○	○	○	○	○	○	○	○	
	RAW							○	○	○	○	○	
	RAW + L							○	○	○	○	○	
ISO speed	Auto	●	●	●	●	●	●	○	○	○	○	○	
	Manual							○	○	○	○	○	
Picture Style	Standard	●			●	●	●	○	○	○	○	○	
	Portrait		●					○	○	○	○	○	
	Landscape			●				○	○	○	○	○	
	Neutral							○	○	○	○	○	
	Faithful							○	○	○	○	○	
	Monochrome							○	○	○	○	○	
	User Defined							○	○	○	○	○	
Color space	sRGB	●	●	●	●	●	●	○	○	○	○	○	
	Adobe RGB							○	○	○	○	○	
White balance	Auto WB	●	●	●	●	●	●	○	○	○	○	○	
	Preset WB							○	○	○	○	○	
	Custom WB							○	○	○	○	○	
	WB correction							○	○	○	○	○	
	WB bracketing							○	○	○	○	○	
Auto Lighting Optimizer		●	●	●	●	●	●	○	○	○	○	○	
AF	One-Shot		●	●	●		●	○	○	○	○	●	
	AI Servo					●		○	○	○	○		
	AI Focus	●					●	○	○	○	○		
	AF point selection	Auto	●	●	●	●	●	●	○	○	○	○	●
		Manual							○	○	○	○	
AF-assist beam		●	●		●		●	○	○	○	○	○	

●: Set automatically ○: User selectable □: Not selectable

Mode Dial		Basic Zone						Creative Zone					
									P	Tv	Av	M	A-DEP
Metering mode	Evaluative	●	●	●	●	●	●	●	○	○	○	○	○
	Partial								○	○	○	○	○
	Center-weighted average								○	○	○	○	○
Exposure	Program shift								○				
	Exposure compensation								○	○	○		○
	AEB								○	○	○	○	○
	AE lock								○	○	○		○
	Depth-of-field preview								○	○	○	○	○
Drive	Single	●		●	●		●	●	○	○	○	○	○
	Continuous		●			●			○	○	○	○	○
	10 sec. self-timer	○	○	○	○	○	○	○	○	○	○	○	○
	2 sec. self-timer								○	○	○	○	○
	Continuous shots after self-timer	○	○	○	○	○	○	○	○	○	○	○	○
Built-in flash	Auto	●	●		●		●						
	Manual								○	○	○	○	○
	Flash off			●		●		●					
	Red-eye reduction	○	○		○		○		○	○	○	○	○
	FE lock								○	○	○	○	○
	Flash exposure compensation								○	○	○	○	○
Live View shooting									○	○	○	○	○

Troubleshooting Guide

If there is a problem, first refer to this Troubleshooting Guide. If this Troubleshooting Guide does not resolve the problem, contact your dealer or nearest Canon Service Center.

Power

The camera does not operate even when the power switch is set to <ON>.

- The battery is not properly installed in the camera. (p.26)
- Recharge the battery. (p.24)
- Make sure the battery compartment cover is closed. (p.26)
- Make sure the card slot cover is closed. (p.31)
- Press the <DISP.> button. (p.42)

The access lamp still blinks even when the power switch is set to <OFF>.

- If the power is cut off while an image is being recorded to the card, the access lamp will light/blink for a few sec. After the image is recorded to the card, the camera turns off automatically.

The battery becomes exhausted quickly.

- Use a fully-charged battery. (p.24)
- The rechargeable battery will degrade after repeated use. Purchase a new one.

The camera turns off by itself.

- Auto power off is in effect. If you do not want auto power off to take effect, set the [**TY** Auto power off] menu to [**Off**].
- Even if [**TY** Auto power off] has been set to [**Off**], the LCD monitor will turn off after the camera is idle for 30 min. Press the <DISP.> button to turn on the LCD monitor.

Shooting

No images can be shot or recorded.

- The card is not properly inserted. (p.31)
- If the card is full, replace the card or delete unnecessary images to make room. (p.31, 130)
- If you try to focus in the One-Shot AF mode while the focus confirmation light <●> in the viewfinder blinks, a picture cannot be taken. Press the shutter button halfway again to focus, or focus manually. (p.37, 62)
- Slide the card's write-protect switch to the Write/Erase setting. (p.31)

The LCD monitor does not display a clear image.

- If dust is adhering to the LCD monitor, wipe with a lens cloth or soft cloth.
- In low or high temperatures, the LCD monitor display may seem slow or it might look black. It will return to normal at room temperature.

The image is out of focus.

- Set the lens focus mode switch to <AF>. (p.33)
- To prevent camera shake, hold the camera still and press the shutter button gently. (p.36, 37)

The card cannot be used.

- If a card error message is displayed, see page 40 or 175.

The camera makes a noise when it is shaken.

- The built-in flash's pop-up mechanism moves slightly. This is normal.

The built-in flash does not fire.

- If you shoot continuously with the built-in flash at short intervals, the flash might stop operating to protect the flash unit.

Image Review & Operation

The image cannot be erased.

- If the image has been erase-protected, it cannot be erased. (p.129)

The shooting date and time displayed is incorrect.

- The correct date and time has not been set. (p.29)

No image appears on the TV screen.

- Make sure the video cable plug is connected all the way in. (p.128)
- Set the video OUT format (NTSC/PAL) to the same video format as the TV. (p.169)
- Use the video cable that came with the camera. (p.128)

Error Codes

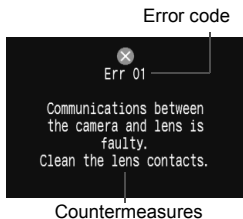

If there is a problem with the camera, an error message appears. Follow the on-screen instructions.

To recover from the error screen, turn the power switch off and on, or remove and reinstall the battery.

If error 02 (Card problem) is displayed, remove and reinstall the card or format the card. This may resolve the problem.

If the same error keeps occurring, there may be a problem. Write down the error code and consult your nearest Canon Service Center.

 If an error code appears right after shooting, the picture might not have been captured. After the error is resolved, press the <▶> button and check if the picture was captured.

System Map

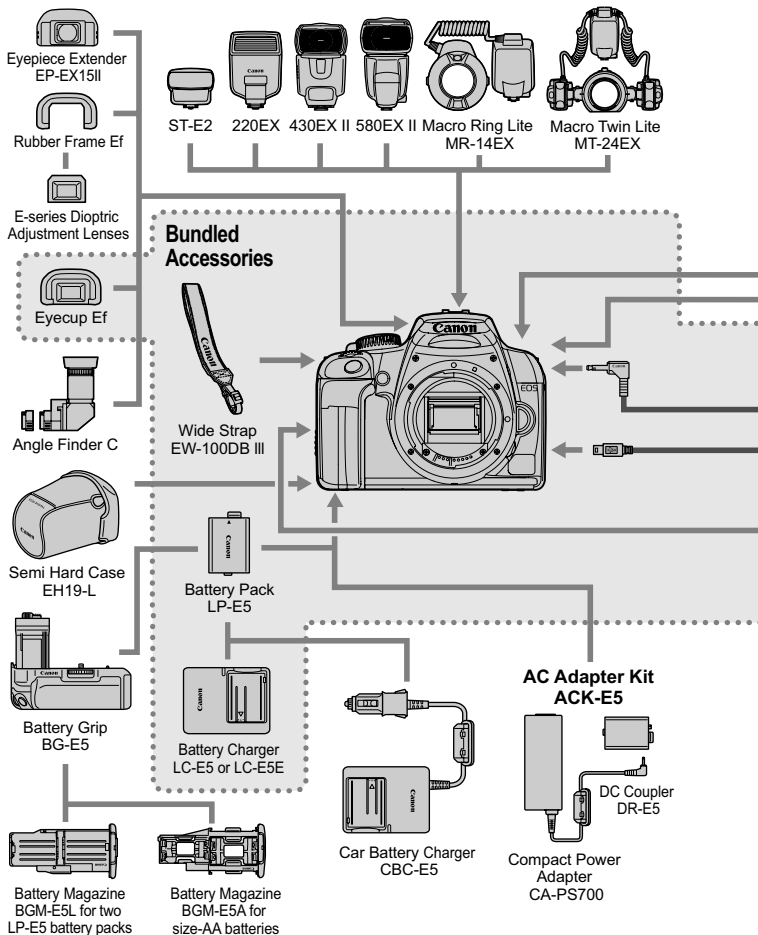

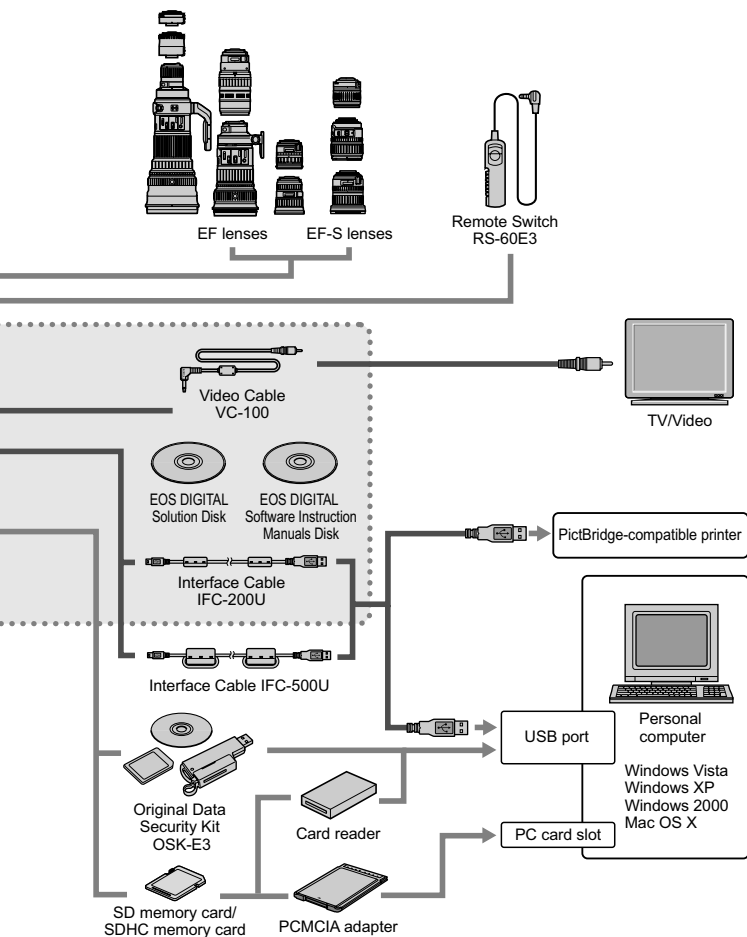

Specifications

• Type

Type:	Digital, single-lens reflex, AF/AE camera with built-in flash
Recording media:	SD memory card, SDHC memory card
Image sensor size:	22.2 mm x 14.8 mm
Compatible lenses:	Canon EF lenses (including EF-S lenses) (35mm-equivalent focal length is approx. 1.6 times the lens focal length)
Lens mount:	Canon EF mount

• Image Sensor

Type:	High-sensitivity, high-resolution, large single-plate CMOS sensor
Pixels:	Effective pixels: Approx. 10.10 megapixels Total pixels: Approx. 10.50 megapixels
Aspect ratio:	3:2
Color filter system:	RGB primary color filter
Low-pass filter:	Located in front of the image sensor, non-removable
Dust deletion feature:	(1) Automatic sensor cleaning (2) Manual cleaning of sensor (3) Dust Delete Data appended to the captured image

• Recording System

Recording format:	Design rule for Camera File System 2.0
Image type:	JPEG, RAW (12-bit Canon original)
RAW+JPEG	
simultaneous recording:	Provided
File size:	(1) Large/Fine : Approx. 3.8 MB (3888 x 2592 pixels) (2) Large/Normal : Approx. 2.0 MB (3888 x 2592 pixels) (3) Medium/Fine : Approx. 2.3 MB (2816 x 1880 pixels) (4) Medium/Normal: Approx. 1.2 MB (2816 x 1880 pixels) (5) Small/Fine : Approx. 1.3 MB (1936 x 1288 pixels) (6) Small/Normal : Approx. 0.7 MB (1936 x 1288 pixels) (7) RAW : Approx. 9.8 MB (3888 x 2592 pixels) * Exact file sizes depend on the subject, ISO speed, Picture Style, etc.
File numbering:	Consecutive numbering, auto reset, manual reset

• Image Processing

Color space:	sRGB, Adobe RGB
Picture Styles:	Standard, Portrait, Landscape, Neutral, Faithful, Monochrome, User Def. 1 - 3
White balance:	Auto, daylight, shade, cloudy, tungsten, white fluorescent light, flash, custom

Color temperature compensation: White balance correction: ± 9 stops in full-stop increments
 White balance bracketing: ± 3 stops in full-stop increments
 * Blue/amber direction or magenta/green direction possible

Color temperature information transmission: Provided

Noise reduction: Noise reduction for long exposures
 High ISO speed noise reduction

Automatic image brightness correction: Auto Lighting Optimizer
 Add original image verification data: Provided (Verified by Original Data Security Kit OSK-E3)

• Viewfinder

Type: Eye-level pentamirror
 Coverage: Vertical/Horizontal approx. 95%
 Magnification: Approx. $0.81\times$ (-1 m^{-1} with 50mm lens at infinity)
 Eyepoint: Approx. 21 mm (from eyepiece lens center)
 Built-in dioptic adjustment: $-3.0 - +1.0\text{ m}^{-1}$ (dpt)
 Focusing screen: Fixed, Precision Matte
 Mirror: Quick-return half mirror (Transmission: reflection ratio of 40:60, no mirror cut-off with EF 600mm f/4L IS USM or shorter lenses)

Viewfinder information: AF information (AF points, focus confirmation light), exposure information (shutter speed, aperture, AE lock, exposure level, ISO speed, exposure warning), flash information (flash ready, high-speed sync, FE lock, flash exposure compensation), monochrome shooting, white balance correction, maximum burst, memory card information

Depth-of-field preview: Enabled with depth-of-field preview button

• Autofocus

Type: TTL secondary image-registration, phase detection
 AF points: 7 AF points
 Metering range: EV 0.5 - 18 (at $23^{\circ}\text{C}/73^{\circ}\text{F}$, ISO 100)
 Focus modes: One-Shot AF, AI Servo AF, AI Focus AF, Manual focusing (MF)
 AF point selection: Automatic selection, manual selection
 Selected AF point display: Superimposed in viewfinder and indicated on LCD monitor
 AF-assist beam: Small series of flashes fired by built-in flash
 Effective range: Approx. 4.0 m/13.1 ft. at center, approx. 3.5 m/11.5 ft. at periphery

• Exposure Control

Metering modes:	35-zone TTL full-aperture metering <ul style="list-style-type: none">• Evaluative metering (linkable to any AF point)• Partial metering (approx. 10% of viewfinder at center)• Center-weighted average metering
Metering range:	EV 1 - 20 (at 23°C/73°F with EF 50mm f/1.4 USM lens, ISO 100)
Exposure control:	Program AE (Full Auto, Portrait, Landscape, Close-up, Sports, Night Portrait, Flash Off, Program), shutter-priority AE, aperture-priority AE, depth-of-field AE, manual exposure, E-TTL II autofocus
ISO speed (Recommended Exposure Index):	Basic Zone modes: ISO 100 - 800 set automatically Creative Zone modes: ISO 100 - 1600 (in 1-stop increments), Auto
Exposure compensation:	Manual: ± 2 stops in 1/3- or 1/2-stop increments (can be combined with AEB) AEB: ± 2 stops in 1/3- or 1/2-stop increments
AE lock:	Automatic: When focus achieved with evaluative metering and One-Shot AF Manual: By AE lock button

• Shutter

Type:	Electronically-controlled, focal-plane shutter
Shutter speeds:	1/4000 sec. to 1/60 sec., X-sync at 1/200 sec. 1/4000 sec. to 30 sec., bulb (Total shutter speed range. Available range varies by shooting mode.)
Shutter release:	Soft-touch electromagnetic release
Self-timer:	10-sec. or 2-sec. delay or 10-sec. delay plus continuous shooting

• Built-in Flash

Type:	Retractable, auto pop-up flash
Flash metering:	E-TTL II autofocus
Guide No.:	13/43 (ISO 100, in meters/feet)
Recycle time:	Approx. 3 sec.
Flash-ready indicator:	Flash-ready icon lights in viewfinder
Flash coverage:	17mm lens angle of view
Flash exposure compensation:	± 2 stops in 1/3- or 1/2-stop increments
FE lock:	Provided

• External Speedlite

Compatible flash:	EX-series Speedlites
Flash metering:	E-TTL II autoflash
Flash exposure compensation:	±2 stops in 1/3- or 1/2-stop increments
FE lock:	Provided
External flash settings:	Flash function settings, Flash C.Fn settings
Zooming to match lens focal length:	Provided

• Drive System

Drive mode:	Single shooting, continuous shooting, self-timer (10-sec., 2-sec., multiple shots)
Continuous shooting speed:	JPEG: Max. approx. 3 shots/sec. RAW: Max. approx. 1.5 shots/sec. RAW+  L: Max. approx. 1.5 shots/sec.
Maximum burst:	JPEG (Large/Fine): Approx. 514, RAW: Approx. 5, RAW+JPEG (Large/Fine): Approx. 4 * Based on Canon's testing standards with a 2GB SD memory card, ISO 100, and Standard Picture Style * Varies depending on the subject, memory card brand, image-recording quality, etc.

• Live View Functions

Shooting modes:	(1) Live View shooting (2) Remote Live View shooting (with a personal computer installed with EOS Utility)
Focusing:	Manual focus Autofocus (Quick mode, Live mode)
Metering modes:	Evaluative metering with the image sensor
Metering range:	EV 0 - 20 (at 23°C/73°F with EF 50mm f/1.4 USM lens, ISO 100)
Grid display:	Provided
Exposure display:	Simulated exposure displayed in real-time

• LCD Monitor

Type:	TFT color liquid-crystal monitor
Monitor size:	2.5 in.
Dots:	Approx. 230,000
Coverage:	Approx. 100%

Brightness adjustment: 7 levels provided

Interface languages: 20

• Image Playback

Display format: Single image, single image + image-recording quality, shooting information, histogram, 4- or 9-image index, magnified view (approx. 1.5x - 10x), rotated image, image jump (by 1/10/100 images, or shooting date)

Highlight alert: Provided (Overexposed highlights blink)

• Image Protection and Erase

Protect: Single images can be erase-protected or not

Erase: Single image, checkmarked images, or all images in the card can be erased (except protected images) at one time

• Direct Printing

Compatible printers: PictBridge-compatible printers

Printable images: JPEG image compliant to Design rule for Camera File System (DPOF printing possible)

Easy Print feature: Provided

• Digital Print Order Format

DPOF: Version 1.1 compatible

• Direct Image Transfer

Compatible images: JPEG and RAW images

* Only JPEG images can be transferred as wallpaper on the personal computer screen

• Customization

Custom Functions: Total 12

My Menu registration: Provided

• Interface

USB terminal: For personal computer communication and direct printing (Hi-Speed USB)

Video OUT terminal: NTSC/PAL selectable

Remote control terminal: For Remote Switch RS-60E3

• Power Source

Battery: Battery Pack LP-E5 (Quantity 1)

* AC power can be supplied via AC Adapter Kit ACK-E5

* With Battery Grip BG-E5, size-AA batteries can be used

Battery life:

[Number of shots • approx.]

Temperature	Shooting Conditions	
	No Flash	50% Flash Use
At 23°C / 73°F	600	500
At 0°C / 32°F	500	400

* With fully-charged Battery Pack LP-E5

* The figures above are based on CIPA (Camera & Imaging Products Association) testing standards

Battery check:

Auto

Power saving:

Provided. Power turns off after 30 sec., 1, 2, 4, 8, or 15 min.

Date/time backup battery:

Built-in secondary battery

Startup time:

Approx. 0.1 sec. (Based on CIPA testing standards)

• Dimensions and Weight

Dimensions (W x H x D): 126.1 x 97.5 x 61.9 mm / 5.0 x 3.8 x 2.4 in.

Weight: Approx. 450 g / 15.9 oz. (body only)

• Operation Environment

Working temperature

range: 0°C - 40°C / 32°F - 104°F

Working humidity: 85% or less

• Battery Pack LP-E5

Type: Rechargeable lithium ion battery

Rated voltage: 7.4 V DC

Battery capacity: 1080 mAh

Dimensions (W x H x D): 36 x 14.7 x 53.1 mm / 1.4 x 0.6 x 2.1 in.

Weight: Approx. 50 g / 1.8 oz. (excluding protective cover)

• Battery Charger LC-E5

Compatible battery: Battery Pack LP-E5

Recharging time: Approx. 2 hours

Rated input: 100 - 240 V AC (50/60 Hz)

Rated output: 8.4 V DC / 700 mA

Working temperature

range: 0°C - 40°C / 32°F - 104°F

Working humidity: 85% or less

Dimensions (W x H x D): 67 x 26 x 87.5 mm / 2.6 x 1.0 x 3.4 in.

Weight: Approx. 80 g / 2.8 oz.

• **Battery Charger LC-E5E**

Compatible battery:	Battery Pack LP-E5
Power cord length:	Approx. 2 m / 6.6 ft.
Recharging time:	Approx. 2 hours
Rated input:	100 - 240 V AC (50/60 Hz)
Rated output:	8.4 V DC / 700 mA
Working temperature range:	0°C - 40°C / 32°F - 104°F
Working humidity:	85% or less
Dimensions (W x H x D):	67 x 26 x 87.5 mm / 2.6 x 1.0 x 3.4 in.
Weight:	Approx. 75 g / 2.6 oz.

• **EF-S 18-55mm f/3.5-5.6 IS**

Angle of view:	Diagonal extent: 74°20' - 27°50' Horizontal extent: 64°30' - 23°20' Vertical extent: 45°30' - 15°40'
Lens construction:	11 elements in 9 groups
Minimum aperture:	f/22 - 36
Closest focusing distance:	0.25 m / 0.82 ft. (From image sensor plane)
Max. magnification:	0.34x (at 55 mm)
Field of view:	207 x 134 - 67 x 45 mm / 8.1 x 5.3 - 2.6 x 1.8 in. (at 0.25 m)
Image Stabilizer:	Lens shift type
Filter size:	58 mm
Max. diameter x length:	Approx. 68.5 x 70 mm / 2.7 x 2.8 in.
Weight:	Approx. 200 g / 7.1 oz.
Hood:	EW-60C
Case:	LP814

• EF-S 18-55mm f/3.5-5.6 II

Angle of view:	Diagonal extent: 74°20' - 27°50' Horizontal extent: 64°30' - 23°20' Vertical extent: 45°30' - 15°40'
Lens construction:	11 elements in 9 groups
Minimum aperture:	f/22 - 36
Closest focusing distance:	0.28 m / 0.92 ft. (From image sensor plane)
Max. magnification:	0.28x (at 55 mm)
Field of view:	248 x 161 - 81 x 54 mm / 9.8 x 6.3 - 3.2 x 2.1 in. (at 0.28 m)
Filter size:	58 mm
Max. diameter x length:	Approx. 68.5 x 66 mm / 2.7 x 2.6 in.
Weight:	Approx. 190 g / 6.7 oz.
Hood:	EW-60C
Case:	LP814

- All specifications above are based on Canon's testing standards.
- The camera's specifications and exterior are subject to change without notice.
- If a problem occurs with a non-Canon lens attached to the camera, consult the respective lens maker.

Trademarks

- Adobe is a trademark of Adobe Systems Incorporated.
- Windows is a trademark or registered trademark of Microsoft Corporation in the United States and other countries.
- Macintosh and Mac OS is a trademark or registered trademark of Apple Inc. in the United States and other countries.
- The SDHC logo is a trademark.
- All other corporate and product names and trademarks mentioned in this manual are the property of their respective owners.

* This digital camera supports Design rule for Camera File System 2.0 and Exif 2.21 (also called "Exif Print"). Exif Print is a standard that enhances compatibility between digital cameras and printers. By connecting to an Exif Print-compliant printer, the shooting information is incorporated to optimize the print output.

Safety Warnings

Follow these safeguards and use the equipment properly to prevent injury, death, and material damage.

Preventing Serious Injury or Death

- To prevent fire, excessive heat, chemical leakage, and explosions, follow the safeguards below:
 - Do not use any batteries, power sources, and accessories not specified in this booklet. Do not use any home-made or modified batteries.
 - Do not short-circuit, disassemble, or modify the battery pack or back-up battery. Do not apply heat or apply solder to the battery pack or back-up battery. Do not expose the battery pack or back-up battery to fire or water. And do not subject the battery pack or back-up battery to strong physical shock.
 - Do not install the battery pack or back-up battery in reversed polarity (+ -). Do not mix new and old or different types of batteries.
 - Do not recharge the battery pack outside the allowable ambient temperature range of 0°C - 40°C (32°F - 104°F). Also, do not exceed the recharging time.
 - Do not insert any foreign metallic objects into the electrical contacts of the camera, accessories, connecting cables, etc.
- Keep the back-up battery away from children. If a child swallows the battery, consult a physician immediately. (Battery chemicals may harm the stomach and intestines.)
- When disposing of a battery pack or back-up battery, insulate the electrical contacts with tape to prevent contact with other metallic objects or batteries. This is to prevent fire or an explosion.
- If excessive heat, smoke, or fumes are emitted during battery pack recharging, immediately unplug the battery charger from the power outlet to stop the recharging and prevent a fire.
- If the battery pack or back-up battery leaks, changes color, deforms, or emits smoke or fumes, remove it immediately. Be careful not to get burned in the process.
- Prevent any battery leakage from contacting your eyes, skin, and clothing. It can cause blindness or skin problems. If the battery leakage contacts your eyes, skin, or clothing, flush the affected area with lots of clean water without rubbing it. See a physician immediately.
- During the recharging, keep the equipment away from the reach of children. The cord can accidentally choke the child or give an electrical shock.
- Do not leave any cords near a heat source. It can deform the cord or melt the insulation and cause a fire or electrical shock.
- Do not fire the flash at someone driving a car. It may cause an accident.
- Do not fire the flash near a person's eyes. It may impair the person's vision. When using flash to photograph an infant, keep at least 1 meter away.
- Before storing the camera or accessory when not in use, remove the battery pack and disconnect the power plug. This is to prevent electrical shock, heat generation, and fire.
- Do not use the equipment where there is flammable gas. This is to prevent an explosion or fire.

- If you drop the equipment and the casing breaks open to expose the internal parts, do not touch the internal parts due to the possibility of electrical shock.
- Do not disassemble or modify the equipment. High-voltage internal parts can cause electrical shock.
- Do not look at the sun or an extremely bright light source through the camera or lens. Doing so may damage your vision.
- Keep the camera from the reach of small children. The neck strap can accidentally choke the child.
- Do not store the equipment in dusty or humid places. This is to prevent fire and electrical shock.
- Before using the camera inside an airplane or hospital, check if it is allowed. Electromagnetic waves emitted by the camera may interfere with the plane's instruments or the hospital's medical equipment.
- To prevent fire and electrical shock, follow the safeguards below:
 - Always insert the power plug all the way in.
 - Do not handle a power plug with wet hands.
 - When unplugging a power plug, grasp and pull the plug instead of the cord.
 - Do not scratch, cut, or excessively bend the cord or put a heavy object on the cord. Also do not twist or tie the cords.
 - Do not connect too many power plugs to the same power outlet.
 - Do not use a cord whose insulation has been damaged.
- Occasionally unplug the power plug and use a dry cloth to clean off the dust around the power outlet. If the surrounding is dusty, humid, or oily, the dust on the power outlet may become moist and short-circuit the outlet to cause a fire.

Preventing Injury or Equipment Damage

- Do not leave equipment inside a car under the hot sun or near a heat source. The equipment may become hot and cause skin burns.
- Do not carry the camera around while it is attached to a tripod. Doing so may cause injury. Also make sure the tripod is sturdy enough to support the camera and lens.
- Do not leave a lens or lens-attached camera under the sun without the lens cap attached. Otherwise, the lens may concentrate the sun's rays and cause a fire.
- Do not cover or wrap the battery-recharging apparatus with a cloth. Doing so may trap heat within and cause the casing to deform or catch fire.
- If you drop the camera in water or if water or metal fragments enter inside the camera, promptly remove the battery pack and back-up battery. This is to prevent fire and electrical shock.
- Do not use or leave the battery pack or back-up battery in a hot environment. Doing so may cause battery leakage or a shorter battery life. The battery pack or back-up battery can also become hot and cause skin burns.
- Do not use paint thinner, benzene, or other organic solvents to clean the equipment. Doing so may cause fire or a health hazard.

If the product does not work properly or requires repair, contact your dealer or your nearest Canon Service Center.



European Union (and EEA) only.

This symbol indicates that this product is not to be disposed of with your household waste, according to the WEEE Directive (2002/96/EC) and your national law. This product should be handed over to a designated collection point, e.g., on an authorized one-for-one basis when you buy a new similar product or to an authorized collection site for recycling waste electrical and electronic equipment (EEE). Improper handling of this type of waste could have a possible negative impact on the environment and human health due to potentially hazardous substances that are generally associated with EEE. At the same time, your cooperation in the correct disposal of this product will contribute to the effective usage of natural resources. For more information about where you can drop off your waste equipment for recycling, please contact your local city office, waste authority, approved WEEE scheme or your household waste disposal service. For more information regarding return and recycling of WEEE products, please visit www.canon-europe.com/environment.

(EEA: Norway, Iceland and Liechtenstein)

Index

A

- Access lamp.....32
- A-DEP
(Automatic depth-of-field AE).....76
- Adobe RGB.....87
- AE lock.....88
- AEB (Auto Exposure Bracketing)....80
- AF → Focusing
- AI Focus AF60
- Angle of view.....34
- Aperture-priority AE72
- Auto Lighting Optimizer.....156
- Auto playback127
- Auto power off.....27, 109
- Auto rotate of vertical image112
- Autofocus → Focusing
- Av (Aperture-priority AE).....72

B

- Basic shooting.....43
- Battery → Power
- Battery check28
- Beeper108
- Black-and-white image.....68
- Bracketing80, 93
- Bulb.....75
 - Noise reduction.....155

C

- Camera
 - Clear camera settings114
 - Holding the camera.....36
- Camera shake35 - 37, 94
 - Image Stabilizer35
- Card.....2, 13, 31
 - Card reminder108
 - Format.....40
- Center-weighted average
metering77
- Clock → Date/Time
- Close-up49
- Color space87
 - sRGB / Adobe RGB
- Color temperature90
- Color tone.....83
- Continuous shooting.....63
- Contrast.....83
- Creative shooting20, 55, 69
- Custom Functions152

D

- Date → Date/Time
- Date/Time.....29
- Depth-of-field preview74
- Dioptric adjustment.....36
- Direct printing → Printing
- Drive mode63
 - Single / Continuous shooting
 - Self-timer.....53

- Dust 34, 118
- Dust Delete Data 119
- E**
- Erase (image) 130
- Error 175
- Evaluative metering 77
- Exposure compensation 78
- 1/2-stop increments 154
- Eyepiece cover 22, 165
- F**
- Faithful 68
- FE lock 89
- File
- Capacity 64
- Number 110
- Size 64
- File number 110
- Continuous / Auto reset /
 Manual reset
- Filter effect 84
- Flash 58
- 2nd-curtain sync 116
- Effective range 58
- External Speedlite 117, 166
- FE lock 89
- Flash exposure
- compensation 79, 116
- Flash off 52
- Menu setting 116
- Red-eye reduction 59
- Shutter speed fixed at
- 1/200 sec 154
- Flash exposure
- compensation 79, 116
- 1/2-stop increments 154
- Focus lock 46
- Focus mode switch 33, 62
- Focusing
- AF mode 60
- AF point selection 61
- AF-assist beam 45
- Beeper 108
- Difficult-to-focus subjects 162
- Live View shooting 98, 102
- Manual focusing 62
- Out of focus 45, 162
- Recompose 46
- Folder 110
- Format (card initialization) 40
- Full Auto 44
- Function availability table 170
- H**
- Highlight alert 131
- Highlight detail loss 131
- Histogram 132
- Brightness / RGB
- Household power 163

I

Image	
Auto playback	127
Erase	130
Highlight.....	131
Histogram	132
Index.....	124
Jump.....	125
Magnified	126
Playback	54, 123
Protect	129
Review time	108
Rotate	126
Shooting information.....	131
Transfer to personal computer ...	147
Viewing on TV	128
Image quality	
Auto correction	156
Image-recording quality	64
Noise reduction.....	155
Picture Style.....	67, 82, 85
Image sensor	
Cleaning	27, 118
Focal plane mark	16, 49
Image Stabilizer (lens)	35
Image-recording quality selection ...	64
Index display	124
ISO speed	57
Item check list	3

J

Jump display	125
--------------------	-----

L

Landscape.....	48, 67
Language	30
LCD monitor	13
Brightness adjustment	109
Display switching	42
Image playback.....	54
Menu operation	38
Off/On	42, 115
Screen color	115
Lens.....	16, 33
Live View shooting	95
Autofocus	102, 157
Possible shots.....	100
Long exposures → Bulb	
Low level format	41



M

M (Manual exposure)	75
Magnified view.....	98, 126
Malfunction	172
Manual exposure.....	75
Manual focusing	62
Maximum burst.....	64, 65
Memory card → Card	
Menu	
Menu settings.....	168
My Menu	160
Operation	38
Metering mode	77
Evaluative / Partial /	
Center-weighted average	
MF (Manual focusing).....	62

- Mirror lockup 94, 157
- Mode Dial → Shooting mode
- Monitor → LCD monitor
- Monochrome image 68
- My Menu 160
- ## N
- Neutral 69
- Night Portrait 51
- Noise reduction 155
- For Long exposures / High ISO speed
- Nomenclature
- Camera 16
 - Lens 16
 - Mode Dial 20
 - Shooting settings 18
 - Viewfinder 19
- Number → File number
- ## O
- One-Shot AF 60
- Original decision
(image verification) data 159
- Overseas (charger) 25
- ## P
- P (Program AE) 56
- Paper settings (printing) 136
- Partial metering 77
- Personal computer
- Image transfer 147
 - Wallpaper 149
- PictBridge 133
- Picture Style
- Customize 82
 - Selection 67
 - User defined 85
- Pixel count selection 64
- Playback → Image
- Portrait 47, 51, 67
- Possible shots 28, 100
- Power
- Auto power off 27, 109
 - Battery 24, 26
 - Battery check 28
 - Household power 163
 - Possible shots 28, 100
 - Power switch 27
- Printing 133
- Page layout 137
 - Paper 137
 - Print Order (DPOF) 143
 - Printing effects 138, 140
 - Trimming 141
- Problem 172
- Program AE 56
- Program shift 56
- Protect (image erase-protection) .. 129
- ## R
- RAW 64, 66
- RAW+  L 64, 66
- Recharge 24
- Red-eye reduction 59
- Remote control shooting 164

Revert to default settings 114
 Rotate (image) 112, 126

S

Safety warnings 186
 Saturation 83
 SD card → Card
 Self-timer 53
 Sensor → Image sensor
 Sepia (Monochrome) 84
 Servo AF 60
 Sharpness 83
 Shooting information display 131
 Shooting mode 20
 A-DEP 76
 Aperture-priority AE 72
 Close-up 49
 Flash off 52
 Full Auto 44
 Landscape 48
 Manual exposure 75
 Night Portrait 51
 Portrait 47
 Program AE 56
 Shutter-priority AE 70
 Sports 50
 Shutter button 37
 Shutter-priority AE 70
 Simultaneous recording
 → RAW+  
 Sports 50
 Strap 22
 System map 176

T

Toning effect (Monochrome) 84
 Sepia / Blue / Purple / Green
 Transfer order (image) 149
 Trimming (printing) 141
 Tv (Shutter-priority AE) 70

V

Viewfinder 19
 Dioptic adjustment 36
 Eyepiece cover 165
 Viewing on TV 128
 Video system (NTSC/PAL) 128

W

WB → White balance
 White balance 90
 Bracketing 93
 Correction 92
 Custom 90

Z

Zoom 34





**CANON INC.**

30-2 Shimomaru 3-chome, Ohta-ku, Tokyo 146-8501, Japan

Europe, Africa & Middle East

CANON EUROPA N.V.

PO Box 2262, 1180 EG Amstelveen, The Netherlands

CANON UK LTD

For technical support, please contact the Canon Help Desk:
Canon UK, RCC Customer Service
Unit 130, Centennial Park, Elstree, Herts, WD6 3SE, UK
Helpdesk: 0844 369 0100 (5 pence/min from a BT landline, other costs may vary)
Fax: 020 8731 4164
www.canon.co.uk

CANON FRANCE SAS

17, quai du Président Paul Doumer
92414 Courbevoie cedex, France
Hot line 0825 002 923 (0,15 €/min.)
www.canon.fr

CANON DEUTSCHLAND GmbH

Europark Fichtenhain A10, 47807 Krefeld, Germany
Helpdesk: 0180 500 6022 (0,14 €/min.)
www.canon.de

CANON ITALIA S.P.A.

Via Milano 8, I-20097 San Donato Milanese (MI), Italy
Servizio clienti: 848 800519 (0,0787 € + 0,0143 €/min)
Fax: 02-8248.4600
www.canon.it

CANON ESPAÑA S.A.

Avenida de Europa nº 6. 28108 Alcobendas (Madrid)
Helpdesk: 901.900.012 (€0,039/min)
Fax: (+34) 91 411 77 80
www.canon.es

CANON BELGIUM N.V. / S.A.

Berkenlaan 3, B – 1831 Diegem, Belgium
Helpdesk : (02) 620.01.97 (0,053 € + 0,053 €/min)
Fax: (02) 721.32.74
www.canon.be

CANON LUXEMBOURG S.A.

Rue des Joncs 21, L-1818 Howald, Luxembourg
Helpdesk : 27 302 054 (0,12 €/min)
Fax: (352) 48 47 96232
www.canon.lu

CANON NEDERLAND N.V.

Neptunusstraat 1, 2132 JA Hoofddorp, The Netherlands
Helpdesk: 0900 – 202 2915 (0,13 €/min)
www.canon.nl

CANON DANMARK A/S

Knud Højgaards Vej 1, DK-2860 Søborg, Denmark
Helpdesk: 70 20 55 15 (0,25DKK + 0,25 DKK/min)
Fax: 70 155 025
www.canon.dk

CANON NORGE as

Hallagerbakken 110, Postboks 33, Holmlia, 1201 Oslo, Norway
Helpdesk: 23 50 01 43 (0,89 NOK + 0,49 NOK/min)
www.canon.no

CANON OY

Kuluttajatuoteet, Huopalahdentie 24, PL1, 00351 Helsinki, Finland
Helpdesk: 020 366 466 (0,02 €/min + pvm tai mpm)
www.canon.fi

CANON SVENSKA AB

Gustav III:s Boulevard 26, S-169 88 Solna, Sweden
Helpdesk: +46 (0)8 519 923 69 (0,23 SEK + 0,45 SEK/min)
Fax: +46 (0)8 97 20 01
www.canon.se

CANON (SCHWEIZ) AG

Industriestrasse 12, 8305 Dietlikon, Switzerland
Helpdesk: 0848 833 838 (0,08 CHF/min)
www.canon.ch

CANON AUSTRIA GmbH

Oberlaaer Strasse 233, A – 1110 Wien, Austria
Helpdesk: 0810 081009 (0,07 €/min)
www.canon.at

CANON PORTUGAL, S.A.

Rua Alfredo Silva, 14 - Alfragide, 2610-016 Amadora, Portugal
Helpdesk: +351 21 42 45 190 (€0,0847 + €0,031/min)
www.canon.pt

WEB SELF-SERVICE: www.canon-europe.com

This Instruction Manual booklet is current as of July 2008. For information on the camera's compatibility with any accessories and lenses introduced after this date, contact any Canon Service Center.

Free Manuals Download Website

<http://myh66.com>

<http://usermanuals.us>

<http://www.somanuals.com>

<http://www.4manuals.cc>

<http://www.manual-lib.com>

<http://www.404manual.com>

<http://www.luxmanual.com>

<http://aubethermostatmanual.com>

Golf course search by state

<http://golfingnear.com>

Email search by domain

<http://emailbydomain.com>

Auto manuals search

<http://auto.somanuals.com>

TV manuals search

<http://tv.somanuals.com>