

BUBBLE JET PRINTER

*i*475D

Quick Start Guide

Table of Contents

Preface	1
Shipping Materials	1
Introduction	1
Setting Up	2
Preparing the Printer	2
Connecting the Printer to the Computer	3
Installing the Print Head	4
Loading Paper	7
Installing the Printer Driver	8
Aligning the Print Head	14
Basic Operations	20
Printing with Windows	20
Printing with Macintosh	22
Print Head Maintenance	24
Appendix	25
Notes on Handling the USB Interface (for Windows Users)	25
For Further Details...	25
Specifications	26

Exif Print

This printer supports Exif 2.2 (also called “Exif Print”).

Exif Print is a standard for enhancing the communication between digital cameras and printers. By connecting to an Exif Print-compliant digital camera, the camera’s image data at the time of shooting is used and optimized, yielding extremely high quality prints.

Canadian Radio Interference Regulations

This digital apparatus does not exceed the Class B limits for radio noise emissions from a digital apparatus as set out in the interference-causing equipment standard entitled “Digital Apparatus,” ICES-003 of the Industry Canada.

Cet appareil numérique respecte les limites de bruits radioélectriques applicables aux appareils numériques de Classe B prescrites dans la norme sur le matériel brouilleur NMB-003 d’Industrie Canada intitulée « Appareils numériques ».

International ENERGY STAR® Program

As an ENERGY STAR® Partner, Canon Inc. has determined that this product meets the ENERGY STAR guidelines for efficiency.



The International ENERGY STAR® Office Equipment Program is a global program that promotes energy saving through the use of computer and other office equipment. The program backs the development and dissemination of products with functions that effectively reduce energy consumption. It is an open system in which business can participate voluntarily. The targeted products are office equipment such as computers, monitors, printers, faxes and copiers. Their standards and logos are uniform among participating nations.

Power Requirements

Never use a power supply voltage other than that supplied in the country of purchase. Using the incorrect voltage could cause a fire or electric shock. The correct power supply voltages and frequencies are as follows:

AC 100-127 V, 50/60 Hz

AC 220-240 V, 50/60 Hz

Preface

Shipping Materials

Thank you for purchasing a Canon Bubble Jet Printer.

Check that all the following items are in the box. If anything is missing or is damaged, contact your Canon Authorized Dealer or Sales Representative.

- Printer
- Setup Software & User's Guide CD-ROM
- Quick Start Guide
- Print Head
- 2 Ink Tanks

* A USB cable should be purchased separately according to your computer. For details on cable specifications, refer to page 3.

Introduction

For information about printing when you connect a PictBridge-compliant digital camera, refer to *Direct Printing for PictBridge-compliant Digital Cameras*.

This Quick Start Guide uses the following symbols to indicate important information. Always observe the instructions indicated by these symbols.

Warning

Instructions that, if ignored, could result in death or serious personal injury caused by incorrect operation of the equipment. These must be observed for safe operation.

Caution

Instructions that, if ignored, could result in personal injury or material damage caused by incorrect operation of the equipment. These must be observed for safe operation.

Also read the Safety Precautions in the User's Guide. Observe the warnings and cautions to avoid personal injury or damage to the printer.

Trademark Notices

- Canon[®] is a registered trademark of Canon Inc.
- BJ is a trademark of Canon Inc.
- Microsoft[®] and Windows[®] are registered trademarks of Microsoft Corporation in the U.S. and other countries.
- Apple, Mac, Macintosh are trademarks of Apple Computer, Inc., registered in the U.S. and other countries.
- CompactFlash is a trademark of SanDisk Corporation.
- MEMORY STICK is a trademark of Sony Corporation.
- SmartMedia[™] is a trademark of Toshiba Corporation.
- Microdrive is a trademark of International Business Machines Corporation.

Copyright ©2003 CANON INC.

All rights reserved. No part of this publication may be transmitted or copied in any form whatsoever without the express written permission.

Setting Up

1 Preparing the Printer

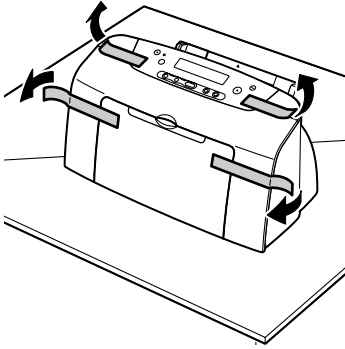

- 1** Place the printer on a flat surface.
- 2** Remove the tape from the printer as shown.

The tape position is subject to change.

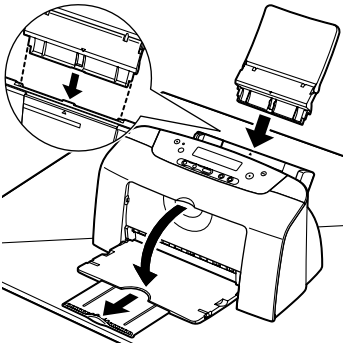

- 3** Attach the paper rest to the sheet feeder.
- 4** Pull out the output tray.

2 Connecting the Printer to the Computer

Use a USB cable.

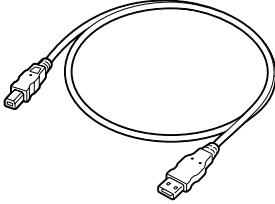

Recommended: Canon or other computer manufacturer cable, up to 5 meters in length.

Notes

- If your computer has an earth connection, make sure that this is attached.
- If you do not intend to use the printer for a long period of time, unplug the power cord from the power outlet after turning off the printer.

Follow the steps below to install the printer driver correctly.

- 1 Ensure that the printer and the computer are switched off.
- 2 Connect the cable.

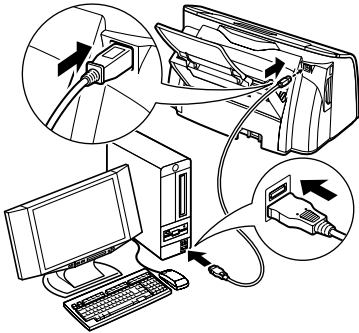

Note

If the Add New Hardware Wizard or Found New Hardware Wizard screen appears when carrying out the following operations, click **Cancel** and turn off the computer.



3 Installing the Print Head

Warning

- Never attempt to plug the power cord into the power outlet or unplug the power cord when your hands are wet.
- Never damage, modify, stretch, or excessively bend or twist the power cord. Do not place heavy objects on the power cord.
- Never use any power supply other than the standard power supply available in the country of purchase. Using the incorrect voltage and frequency could cause a fire or electric shock.
- Always push the plug all the way into the power outlet.

■ Installing the Print Head

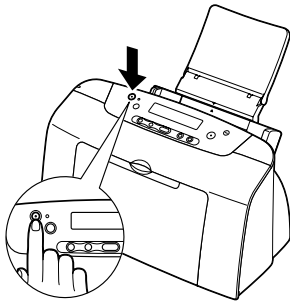

ON

1 Plug the printer in.

2 Turn on the printer. Do NOT turn on the computer yet.

The POWER lamp flashes and the printer begins to operate. Wait until the POWER lamp remains fully lit.

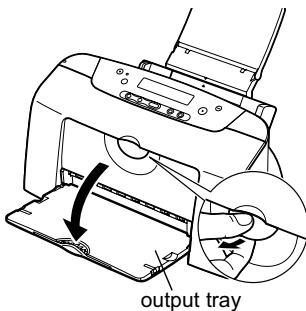

output tray

3 Open the output tray.

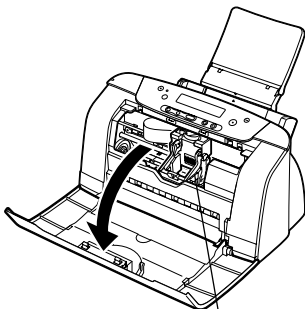

print head holder

4 Open the front cover.

The print head holder moves to the center.

lock lever

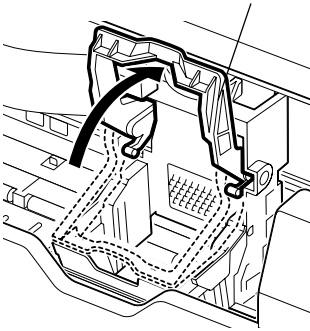

5 Raise the lock lever.

Do not touch internal parts other than the lock lever.

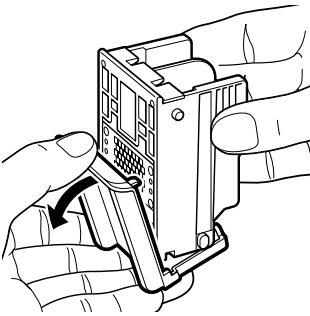

6 Remove the protective cap from the print head.

→ Notes

- Do not touch the print head nozzles or electrical contacts.
- Do not attempt to reattach the protective cap once it has been removed.

print head
nozzles electrical
 contacts

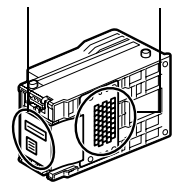

print head

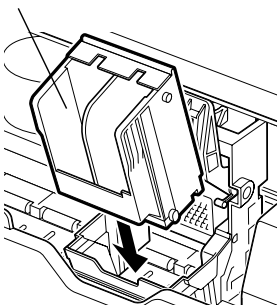

7 Place the print head in the holder.

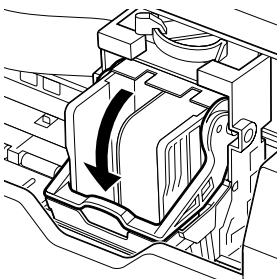

8 Lock the print head into place by lowering the lever.

Do not touch the lock lever once the print head has been installed.

■ Installing the Ink Tanks

⚠ Caution

- For safety reasons, store ink tanks out of the reach of small children.
- Do not drop or shake ink tanks as this may cause the ink to leak out and stain your clothes and hands.

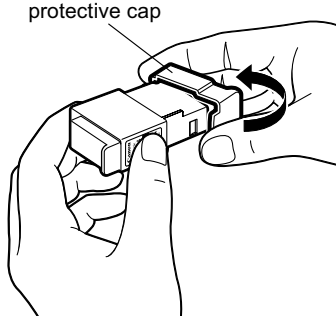

- 1** Take out the black ink tank.
- 2** Hold the ink tank as shown in the diagram and remove the protective cap.

→ Notes

- Do not touch the ink port.
- Do not attempt to reattach the protective cap once it has been removed.

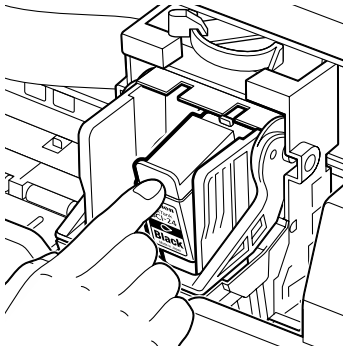
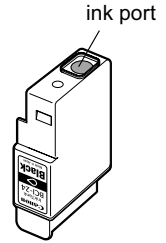

- 3** Insert the black ink tank into the right-hand slot.
- 4** Press the tab until it clicks into place.

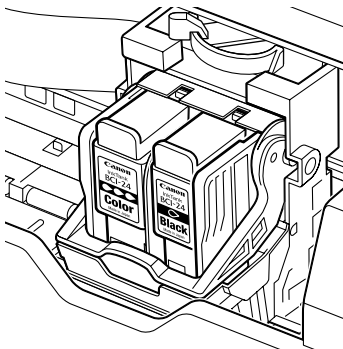

- 5** Use the same procedure to install the color ink tank in the left-hand slot.
- 6** Close the front cover.

Wait until the POWER lamp remains fully lit (about 60 seconds).

4 Loading Paper

■ Loading A4 (Letter) Size Plain Paper

paper thickness lever

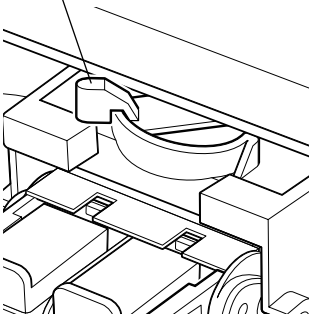

- 1 Open the front cover.
- 2 Move the paper thickness lever at the top of the print head holder to the left position. Close the front cover.

↳ **Note**

Set the paper thickness lever to the left when using plain paper, to the right when using thick paper. Refer to the User's Guide for information on loading envelopes and other media.

- 3 Pull out the paper rest and the output tray as shown.

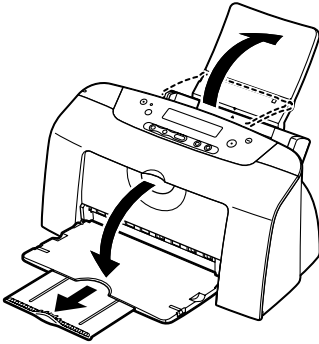

- 4 To avoid paper jams, fan the stack to remove static cling, then align the edges of the stack by tapping it on a flat surface.

- 5 Load the paper, aligning it with the right side of the sheet feeder.

You can load a maximum of 100 sheets of plain paper. Do not exceed this limit.

- 6 Press the paper guide and slide it against the left side of the stack of paper.

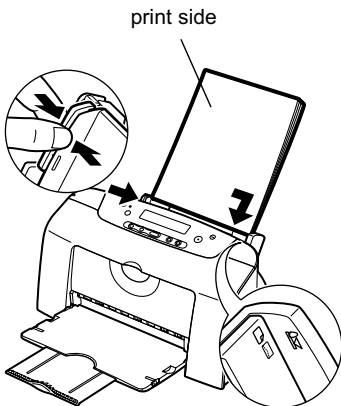

You now need to install the printer driver:

Windows: Go to page 8

Mac OS X: Go to page 11

5 Installing the Printer Driver

→ Notes

If you are printing with only Direct Print, skip this chapter and go to “Aligning the Print Head” on page 14.

■ Installing the Printer Driver – Windows

→ Notes

- Do not disconnect the cable or remove the CD-ROM during the installation. The driver cannot be correctly installed.
- The screens below refer to Windows XP installation. Screen may differ depending on the operating system you are using.
- When installing the printer driver in Windows XP or Windows 2000, log on to the system as a member of the **Administrators** group.
- The Setup Software & User’s Guide CD-ROM contains the application software. If you want to install the application software, click **Install** on step 7. Internet Explorer 4.0 or later must be installed for Easy-PhotoPrint.

If the following screen appears automatically, click **Cancel** and follow steps 1 to 8 to install the printer driver.



Special Notes for Windows 98 or Windows Me USB Users

Click **Cancel** to quit the screen and turn off the printer. Next, remove and replace the USB cable connected to your computer.

OFF

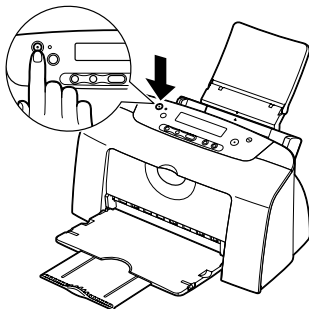

- 1** Ensure that the printer and computer are switched off.
- 2** Turn on the computer and start Windows. If any applications automatically run, quit them.

Disable any virus detection programs.
Do NOT turn the printer on at this stage.

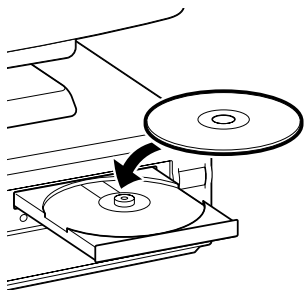

- 3 Place the Setup Software & User's Guide CD-ROM in the CD-ROM drive.

→ **Notes**

- If the CD-ROM does not run automatically, click **Start** and select **My Computer**, and then double-click the CD-ROM icon. For non-XP Windows users, double-click **My Computer** in the Windows screen, and the CD-ROM icon.
 - If the language selection screen appears, select a language, then click **Next**.
-



- 4 Follow the instructions displayed on screen. When the screen shown on the left is displayed, click **Install**.

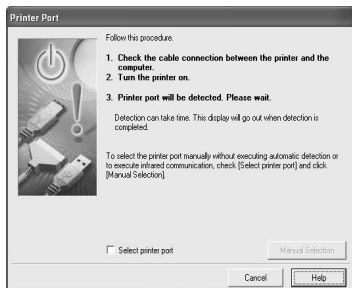

- 5 When the screen shown on the left appears, turn the printer on.

If the printer is recognized, the printer driver will be automatically installed.

→ **Note**

If the connection is not recognized, refer to the section “Notes on Handling the USB Interface (for Windows Users)” on page 25.

ON

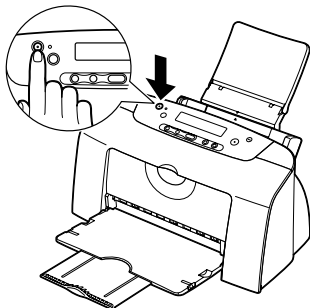



6 Click **OK**.

Before you use the printer, you must carry out print head alignment on page 14.

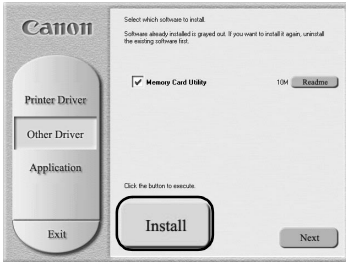

7 Click **Install** to install the memory card utility.



8 Click **OK**.



9 If you want to install the application software, click **Install**.

Follow the instructions on screen to install the application software. When the message “Software installation is completed.” is displayed, click **OK**.

10 Click **Exit**.

→ Notes

- The User’s Guide is also installed when you install the printer driver. To view the User’s Guide, double-click the User’s Guide short-cut icon on the desk top.
 - If a message prompting you to restart the computer is displayed, click **Yes**.
 - For further information of applications and how to start them, refer to “Applications Included in the CD-ROM Package” on page 26.
-

■ Installing the Printer Driver – Macintosh

→ Notes

- Do not remove or insert the USB cable during installation, as this may result in the computer or printer not operating normally.
- Before installing the driver, disable all virus detection programs and automatically loading programs or remove them from your system folder.
- The Setup Software & User's Guide CD-ROM contains the application software, Easy-PhotoPrint, to import and print image data. If you want to install Easy-PhotoPrint, double-click the application folder, the Easy-PhotoPrint folder, and **Installer**.
- For Mac OS 8.6-9.x users, refer to the Printer Driver Guide for Mac OS 9 for instructions on how to install the printer driver.

- 1** Turn on the Mac.
- 2** Place the Setup Software & User's Guide CD-ROM in the CD-ROM drive.
- 3** Double-click the **Mac OS X** folder, and then double-click the **Printer Driver** folder.
- 4** Double-click **i475D.mpkg**.
- 5** Enter an administrator name and a password, then click **OK**.
- 6** Click **Continue**.
- 7** Read the License Agreement and click **Continue**, then click **Agree**.

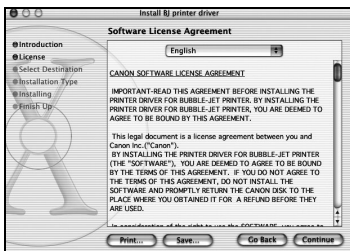
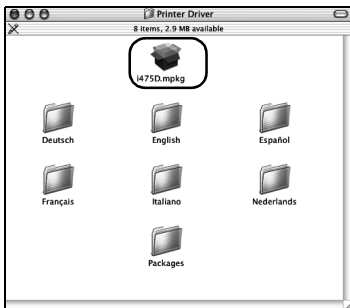
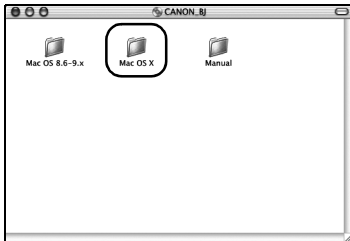

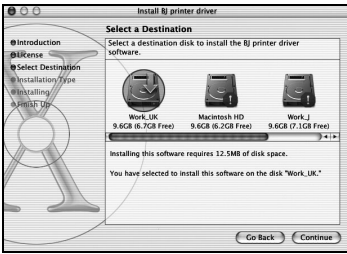

- 8** Select a destination to where you want to install the printer driver, and click **Continue**.

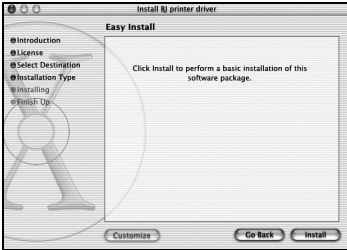

- 9** Click **Install**.

- 10** A message asking for your confirmation to restart your computer is displayed on the screen. Read the message, then click **Continue Installation**.

Software installation will start.

- 11** Software installation is complete. Restart your computer.

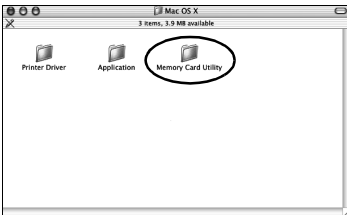

- 12** Double click the **Memory Card Utility** folder of the **Mac OS X** folder.

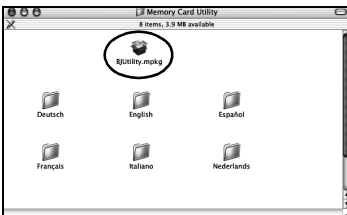

- 13** Double click **BJUtility.mpkg**.

- 14** Enter an administrator name and a password, then click **OK**.

- 15** Click **Continue**.

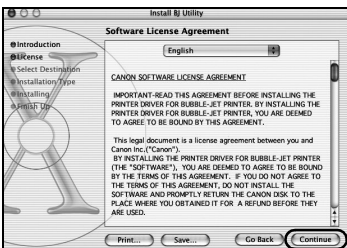

- 16** Read the License Agreement and click **Continue**, then click **Agree**.

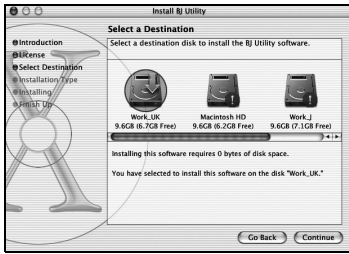

17 Select a destination to where you want to install the memory card utility, and click **Continue**.

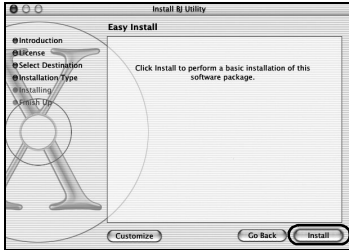

18 Click **Install**.

19 A message asking for your confirmation to restart your computer is displayed on the screen. Read the message, then click **Continue Installation**.

Software installation will start.

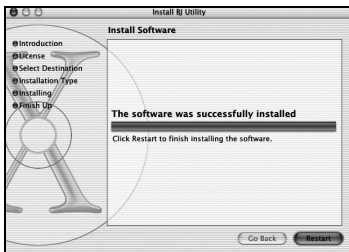

20 Software installation is complete. Restart your computer.

Before you use the printer, you must carry out print head alignment on page 16.

6 Aligning the Print Head

This operation must be carried out when using the printer for the first time. Aligning the print head positions allows you to print without shifts in the color registration.

■ Aligning the Print Head – Windows

- 1 Click **Start** and select **Control Panel, Printers and Other Hardware**, and then **Printers and Faxes**.

↳ **Note**

For non-XP Windows users, click **Start**, then select **Settings, Printers**.

- 2 Click the icon for your printer.
- 3 Open the **File** menu and select:

- Windows XP/Windows 2000 → [Printing Preferences...]
- Windows Me/Windows 98 → [Properties]

to open the setting screen.

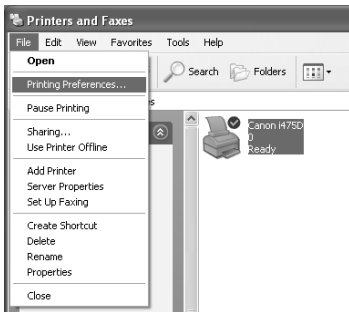

- 4 Click the **Maintenance** tab, and click **Print Head Alignment**.

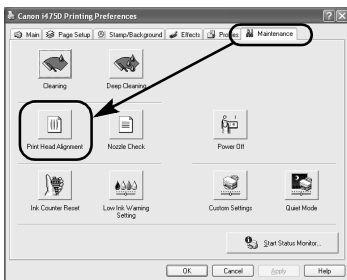

- 5 Check that paper is loaded in the printer and click **OK**. If a message warning you not to perform other operations is displayed, click **OK**.

It takes about 60 seconds to start printing.

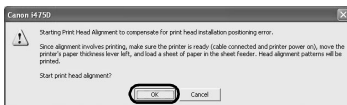

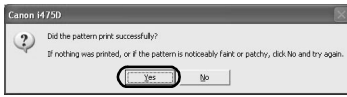

6 After the pattern is printed, click **Yes**.

If the pattern is not printed successfully, open the front cover and ensure that the ink tanks are correctly installed.

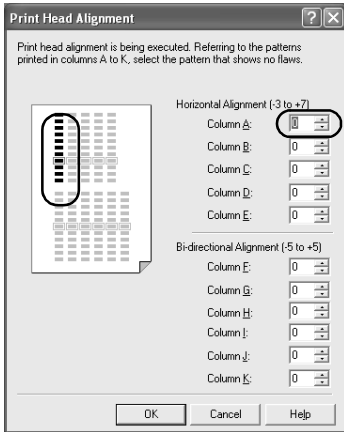

7 Look at the print-out. From the patterns in Column A, select the most even, least irregular pattern and enter the number.

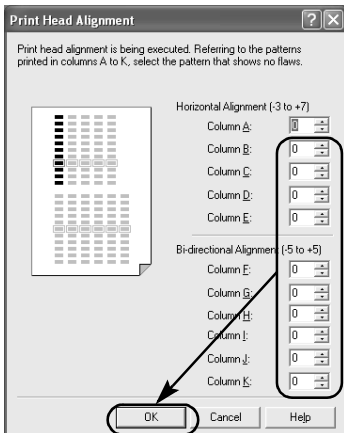

8 In the same way, one by one, select the most even patterns printed with the least irregularities from each of Columns B to K, enter their numbers, and click **OK**.

If it is difficult to pick the best pattern on Column H, pick the setting that produces the least noticeable vertical white stripes.



Less noticeable white stripes



More noticeable white stripes

9 Click **OK**.

This completes the printer setup. The printer is now ready to use.



■ Aligning the Print Head – Macintosh

↳ Note

For Mac OS 8.6-9.x users, refer to the Printer Driver Guide for Mac OS 9 for instructions on how to align the print head.

- 1 Open the BJ Printer Utility dialog box.
 - (1) Double-click the hard disk icon where the printer driver was installed, the **Applications** folder, and the **Utilities** folder.
 - (2) Double-click the **Print Center** icon.
 - (3) Select **i475D** from the **Name** list and click **Configure**.
 - (4) Select **i475D** from the **Product** list and click **Select**.

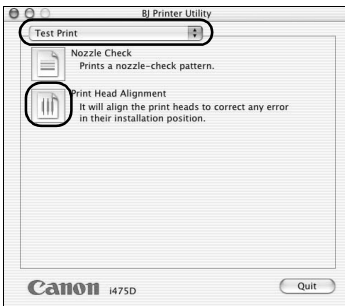

2 Print the pattern.

- (1) Select **Test Print** from the pop-up menu.
- (2) Click **Print Head Alignment**.

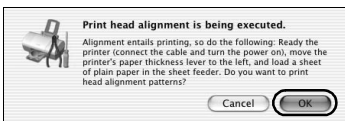

3 Check that paper is loaded in the printer and click OK.

It takes about 60 seconds to start printing.

If the pattern is not printed successfully, open the front cover and ensure that the ink tanks are correctly installed.

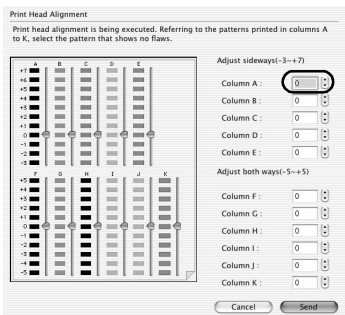

4 Look at the print-out. From the patterns in Column A, select the most even, least irregular pattern and enter the number.

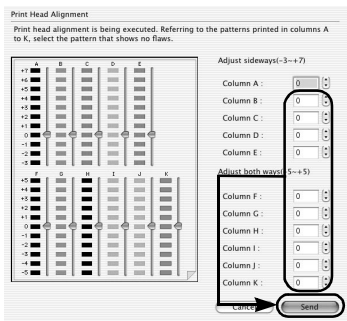

- 5** In the same way, one by one, select the most even patterns printed with the least irregularities from each of Columns B to K, enter their numbers and click **Send**.

If it is difficult to pick the best pattern on Column H, pick the setting that produces the least noticeable vertical white stripes.



Less noticeable white stripes

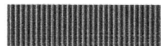

More noticeable white stripes

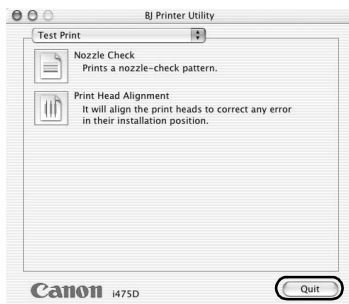

- 6** Click **Quit**.

This completes the printer setup. The printer is now ready to use.

■ Aligning the Print Head – Operation Panel

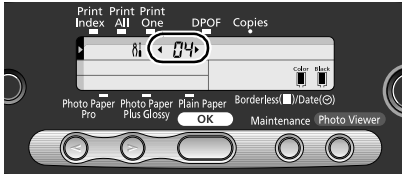

1 Press the **Maintenance** button.

2 Press  three times to display **04** on the LCD.

3 Press the **OK** button.

The pattern is printed.

4 Observe the printed patterns and check the pattern in which vertical stripes are least noticeable.

If the patterns in column “H” are not uniform, select the pattern in which white stripes are least noticeable.

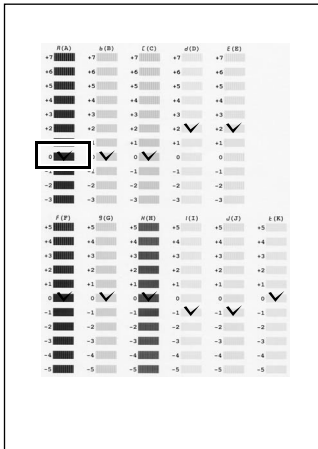



Less noticeable white stripes

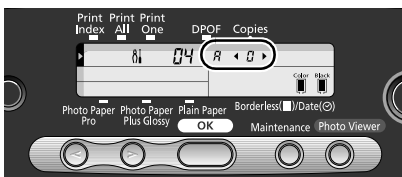

More noticeable white stripes



5 Using   (cursor buttons), display the pattern number (+7 to –3) of the checked patterns in column A.

6 Press the **OK** button.

The screen for selecting a pattern in column B (“b”) appears.

↳ **Note**

To cancel an operation, press the **Maintenance** button and retry the procedure from the beginning.

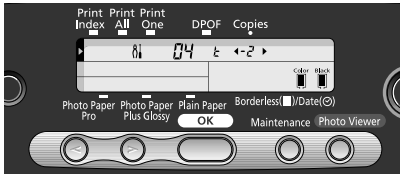

7 Repeat the above procedure to determine the pattern numbers (+7 to –3) of the checked patterns in columns B through E and the pattern numbers (+5 to –5) of the checked patterns in columns F through K.

When pattern numbers have been determined up to column K, maintenance mode number “04” is displayed again and head alignment is complete.

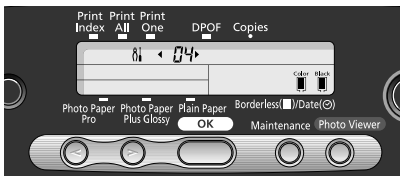

8 Press the **Maintenance** button.

You can exit the maintenance mode.

Basic Operations

⚠ Caution

- If you detect smoke, unusual smells or strange noises around the printer, immediately switch the printer off and always unplug the printer. Contact your local Canon service representative.
- To avoid injury, never put your hand or fingers inside the printer while it is printing.

Printing with Windows

Adjusting the print settings according to your needs allows you to produce better quality prints. In this section, we will use WordPad for the purpose of explanation. The procedures you use and the screens that appear on your computer may differ according to the application that you use.

■ Printing

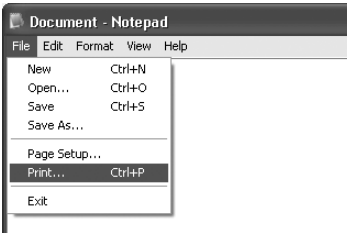

1 Print the document from the application.

On the **File** menu, click **Print**.

Check the application's user's manual for the actual procedures.

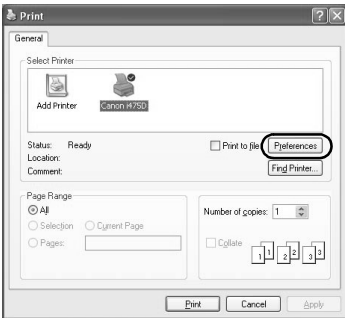

2 Ensure that your printer is selected, then click:

- Windows XP → [Preferences]
- Windows Me/Windows 98 → [Properties]
- Windows 2000 → [Main] tab

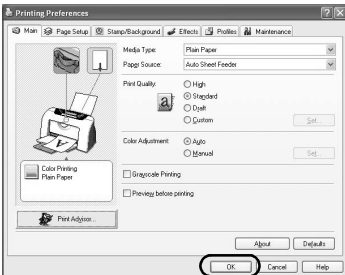

3 Specify the required settings and click **OK**.

➔ Note

If you use anything other than plain paper, please refer to “Basic Print Settings” on page 21.

4 To start printing, click **OK**.

Printing will start in a few moments.

■ Basic Print Settings

For the best print quality, specify the minimum requirement settings in the **Main** tab. To get the best results, ensure that you select the media loaded in the printer when printing on paper other than plain paper.

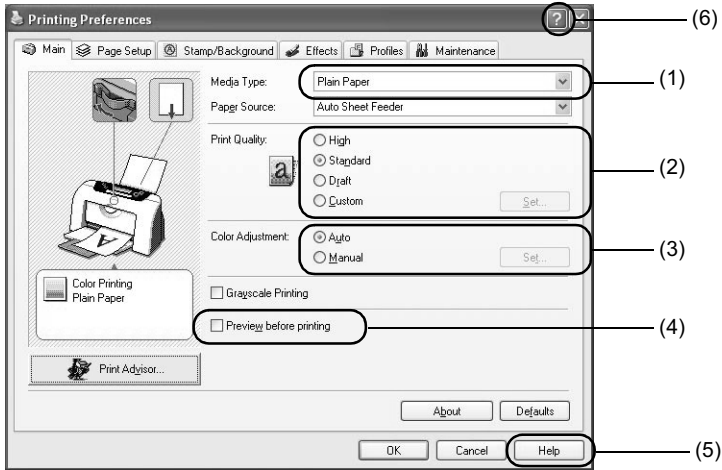

(1) Media Type	Select the media loaded in the printer.
(2) Print Quality	Select one option from High , Standard and Draft . Select Custom to set the print quality manually.
(3) Color Adjustment	If you wish to control the color adjustment settings in more detail, select Manual .
(4) Preview before printing	Select this to check the layout before printing.
(5) Help	Click this for a more detailed explanation of the functions in the tab. (This may not appear in Windows XP or Windows 2000. If this happens, click Start then select All Programs (or Programs) - Canon i475D - Guide).
(6) ?	Click this to change the cursor shape to ?. By clicking on the item's name with this ? cursor, an explanation will be displayed.

→ Notes

- Clicking the **Print Advisor** allows you to change to the most appropriate print settings simply by answering questions when prompted.
- Use the application to set the paper size and paper orientation. Before printing, open the settings screen and check that the **Page Size** in the **Page Setup** tab is the same as that specified within application.
- Refer to the User's Guide for more information about printer driver functions.

Printing with Macintosh

Adjusting the print settings according to your needs allows you to produce better quality prints.

■ Printing

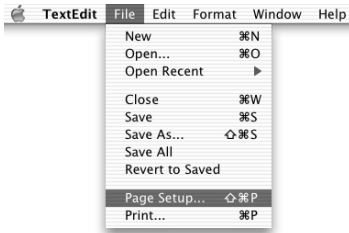

- 1 Open the **Page Setup** dialog box in your application.

On the **File** menu, click **Page Setup**. Check the application's user's manual for the actual procedures.

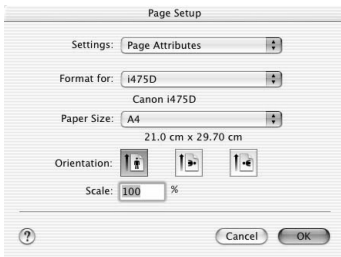

- 2 Specify the page setup.

For details, refer to “Page Setup” on page 23.

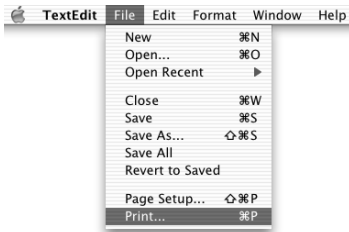

- 3 Open the Print dialog box in your application to print the document.

On the **File** menu, click **Print**. Check the application's user's manual for the actual procedures.

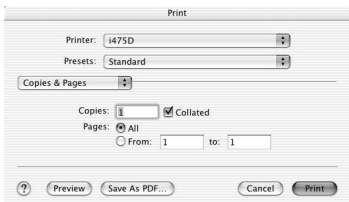

- 4 Specify the print settings according to your requirements.

For details, refer to “Basic Print Settings” on page 23.

- 5 Click **Print**.

Printing will start in a few moments.

■ Page Setup

Use the **Page Setup** dialog box to specify the paper size settings.

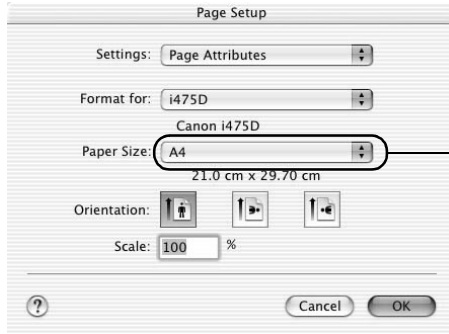

Select paper size you wish to use.

■ Basic Print Settings

For the best print quality, specify the minimum requirement settings in the **Print** dialog box. Select **Quality & Media** from the pop-up menu to change the display of the dialog box. To get the best results, ensure that you select the media loaded in the printer when printing on paper other than plain paper.

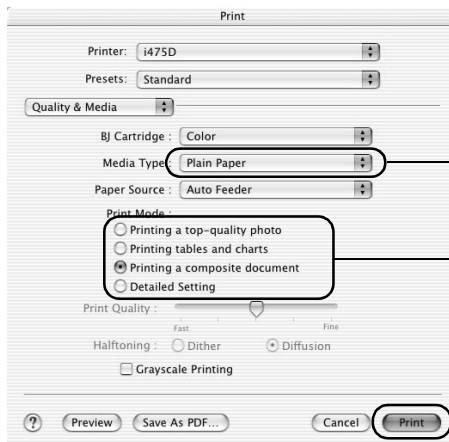

(1)

(2)

(3)

(1) Media Type	Select the media loaded in the printer.
(2) Print Mode	Select the type of document you want to print. To specify more detailed settings for the print quality, click Detailed Setting .
(3) Print	Click this to start printing.

➔ Notes

- See Help for more information about other printer driver functions.
Click  in the **Page Setup** dialog box or the **Print** dialog box.
- Refer to the User's Guide for more information about printer driver functions.

Print Head Maintenance

■ If Blurring Occurs or If a Specific Color Does Not Print

Perform print head cleaning to improve the print quality. Ensure that the printer is turned on and follow the instructions below.

- Windows
Open the printer driver settings screen and click the **Maintenance** tab. Click **Cleaning**. See page 14 for details on how to open the setting screen.
- Macintosh
Open the **BJ Printer Utility**, and select **Cleaning** from the pop-up menu. Click **Cleaning**. See page 16 for details on how to open the **BJ Printer Utility**.

■ When the Printer Runs out of Ink

Replace the empty ink tank with a new one.
Specify the following ink tanks when purchasing.

Ink Tank BCI-24 Color

Ink Tank BCI-24 Black

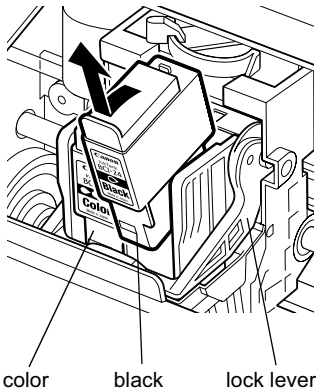

1 Open the front cover and remove the empty ink tank.

Do not touch the lock lever.

2 Install the new ink tank.

Close the front cover when finished.

↳ **Note**

When you enable the low ink warning, reset the ink counter of the ink tank installed. Refer to the User's Guide for more detailed procedures and information about maintenance.

Appendix

Notes on Handling the USB Interface (for Windows Users)

If installation of the printer driver does not proceed as instructed in this Quick Start Guide, there may be a problem with the USB driver installation.

Try reinstalling the printer driver.

■ Reinstalling

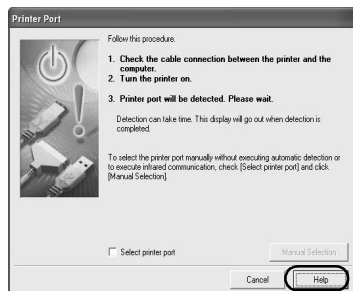

If you cannot proceed beyond the **Printer port** screen:

- 1 Click **Cancel**.
- 2 When the **Terminate Installation** screen is displayed, click **OK**.
- 3 Click **Exit**, then remove the CD-ROM.
- 4 Turn the printer off.
- 5 Restart the computer.
- 6 Reinstall the printer driver (see page 8).

For Further Details...

For more information, place the Setup Software & User's Guide CD-ROM in the CD-ROM drive.

■ User's Guide Contents

The "User's Guide" is HTML manual you can browse through on your computer.

Contents

- Printer parts and their functions
- Further printing techniques
- Routine maintenance
- Printing media
- Troubleshooting
- Specifications

■ How to View the User's Guide

For Windows

Double-click the **User's Guide** short-cut icon on the desk top, or select **All Programs** (or **Programs**) from the **Start** menu, then **Canon i475D - User's Guide**.

For Macintosh

- (1) Load the CD-ROM in your computer.
- (2) Double-click the **Manual** folder.
- (3) Double-click the **User's Guide** folder.
- (4) Select a language folder.
- (5) Double-click the icon for the **i475D_UG_ENG.htm** file.

■ Applications Included in the CD-ROM Package

Easy-PhotoPrint (Windows/Macintosh)

You can make a Borderless Printing easily and quickly, just by selecting a photograph taken with a digital camera and the paper type on which to print. You can also use simple editing features such as trimming and image rotation.

It is Exif Print (Exif 2.2) compatible.

Easy-WebPrint (Windows)

You can easily print homepages displayed on Internet Explorer or pages from User's Guide (HTML manual of this printer) in full size.

Easy-WebPrint automatically adjusts the layout when printing a screen.

This feature enables you to print a screen without its right end being cut.

This application is a plug-in for Internet Explorer, and its toolbar is automatically added to Internet Explorer after installation.

Specifications

■ Printer

Printing resolution:

4800* X 1200 dpi. max.

* Ink droplets can be placed with a pitch of 1/4800 inch at minimum.

Print speed (printing with Canon standard pattern):

Black printing

Max Speed (Custom Setting 5): 18 ppm

Standard: 11.8 ppm

Color printing

Max Speed (Custom Setting 5): 12 ppm

Standard: 4.9 ppm

Print width:

203.2 mm max. (8.0 in)

(for Borderless Printing: 216 mm/8.5 in)

Resident print control mode:

Canon extended mode

Receive buffer:

56 KB

Interface:

USB/Direct Print Port

Acoustic noise level:

Approx. 45 dB (A) (in the highest print quality mode)

Operating environment:

Temperature: 5 to 35°C (41 to 95°F)

Humidity: 10 to 90%RH (no condensation)

Storage environment:

Temperature: 0 to 40°C (32 to 104°F)

Humidity: 5 to 95% RH (no condensation)

Power supply:

AC 100-127 V, 50/60 Hz

AC 220-240 V, 50/60 Hz

Power consumption:

Standby: Approx. 3 W
Printing: Approx. 16 W

Dimensions**(without a paper rest and paper output tray retracted):**

393 (W) X 258 (D) X 218 (H) mm
15.47 (W) X 10.16 (D) X 8.58 (H) in

Weight:

Approx. 4.0 kg (8.82 lb.)

Print Head:

Black: 320 nozzles (600 dpi)
Cyan, Magenta, Yellow: 256 nozzles per each color (600 dpi)

Ink Tanks:

Capacity (pages):
Black (BCI-24 Black) approx. 300*¹, approx. 580*²
Color (BCI-24 Color) approx. 160*²

*1 1500 characters per page, normal text, at standard and plain paper mode with Windows XP printer driver

*2 Based on printing the ISO JIS-SCID No.5 pattern at standard and plain paper mode with Windows XP printer driver

Supported recording media:

CompactFlash Card, SmartMedia Card, SD Card, MultiMedia Card, Microdrive
(Other memory cards can be used through the adapter which is compatible with the above.)

Supported recording formats:

JPEG (DCF/CIF/Exif 2.2 or earlier/JFIF), TIFF (Exif compliant), DPOF compliant

■ “Bubble Jet Direct” Print

Compatible Paper:

Card #1 (Photo Paper Pro 4” X 6”/101.6 X 152.4 mm), Card #2 (Photo Paper Plus Glossy 4” X 6”/101.6 X 152.4 mm), Card #3 (Photo Paper Plus Glossy 5” X 7”/127.0 X 177.8 mm), LTR (Photo Paper Pro or Photo Paper Plus Glossy Letter), A4 (Photo Paper Pro or Photo Paper Plus Glossy A4)

Layout Print:

Standard: Borderless / with border, Index Print: 15-35 images

Print Quality:

1 level

Effect:

Exif Print Compatible

DPOF Functions:

Ver. 1.00 compatible (Index print, number of copies, select images, print special characters (date/image no.))

■ BJ Printer Driver Systems Requirements

For Windows

- Use a computer equipped on which Windows XP, Windows 2000, Windows Me, or Windows 98 can operate.
- USB* interface
- Available hard-disk space for printer driver installation (including temporary files)

Windows XP/Windows 2000: 75MB

Windows Me/Windows 98: 40MB

(Including the capacity for the electric manual)

*USB operation can only be guaranteed on a PC with pre-installed Windows XP, Windows 2000, Windows Me, or Windows 98. (This includes Windows XP, Windows 2000, or Windows Me upgraded from pre-installed Windows 98 or later)

For Macintosh

- Use a Macintosh series computer equipped with USB interface on which Mac OS X v.10.2.1 or later or Mac OS 8.6-9.x can operate.
- Available hard-disk space for printer driver installation

Mac OS X v.10.2.1 or later: 110 MB

Mac OS 8.6-9.x: 40 MB

- The following functions are not supported when using Mac OS X v.10.2.1 or later:
 - Duplex Printing
 - Photo Optimizer Pro

Additional Systems Requirements for Electric Manual

- Pentium® 75 MHz equivalent or higher processor (Pentium® 133MHz equivalent or higher processor recommended)
- 2x or higher CD-ROM drive (4x or higher recommended)
- Microsoft Internet Explorer 5.0 or later



Free Manuals Download Website

<http://myh66.com>

<http://usermanuals.us>

<http://www.somanuals.com>

<http://www.4manuals.cc>

<http://www.manual-lib.com>

<http://www.404manual.com>

<http://www.luxmanual.com>

<http://aubethermostatmanual.com>

Golf course search by state

<http://golfingnear.com>

Email search by domain

<http://emailbydomain.com>

Auto manuals search

<http://auto.somanuals.com>

TV manuals search

<http://tv.somanuals.com>