

Canon

Exif Print

PictBridge

PIXMA MP460

User's Guide



ENG

QT5-0576-V06

Getting Help from Canon

Help Us Help You Better

Before you contact Canon, please record the following information.

Serial Number (located on the inside of the product): _____

Model Number (located on the front of the product): _____

Setup CD-ROM number (located on the CD-ROM): _____

Purchase Date: _____

Customer Technical Support Sequence*

1. Internet - www.canontechsupport.com

For quick and comprehensive self-help in an intuitively guided interactive troubleshooting environment, the place to start is our helpful tech support web site. In addition, the latest driver downloads, answers to frequently asked questions, product information, and “where to buy” instructions are found here.

2. Email Tech Support - www.canontechsupport.com

For individual attention to a special issue, try emailing our friendly technical support representatives, specially trained to communicate quick, easy, and logical solutions to your inquiries within 24 hours.

3. Toll-Free Live Tech Support - (1-800-828-4040)

This option provides live telephone technical support, free of service charges, Monday-Saturday (excluding holidays), during your product’s 1 year limited warranty period. Telephone Device for the Deaf (TDD) support is available at (1-866-251-3752).

4. Extended Service and Support - www.canonesp.com

Canon CarePAK Extended Service Plan is a cost-attractive and easy-to-use extended service program that provides up to three full years of service and support coverage at a very attractive price. CarePAK offers toll-free Canon technical support and includes Canon’s superb InstantExchange product replacement program. For further information about extending your Canon service and support, call (1-800-385-2155), or visit our Web site at www.canonesp.com. CarePAK must be purchased during your product’s warranty period.

For more information and updated program specifics, please visit our web site at www.canontechsupport.com.

*Support program specifics are subject to change without notice.

Disclaimer

Canon Inc. has reviewed this manual thoroughly in order that it will be an easy-to-use guide to your Canon MP460. All statements, technical information and recommendations in this manual and in any guides or related documents are believed reliable, but the accuracy and completeness thereof are not guaranteed or warranted, and they are not intended to be, nor should they be understood to be, representations or warranties concerning the products described. Specifications are subject to change without notice.



As an ENERGY STAR® partner, Canon Inc. has determined that this product meets the ENERGY STAR® guidelines for energy efficiency.



This machine supports Exif 2.21 (also called "Exif Print"). Exif Print is a standard for enhancing the communication between digital cameras and printers. By connecting to an Exif Print-compliant digital camera, the camera's image data at the time of shooting is used and optimized, yielding extremely high quality prints.

About Consumables

Consumables (ink tanks / FINE Cartridges) are available for 5 years after production has stopped.

Trademark Notices

- Windows is a registered trademark of Microsoft Corporation in the United States and other countries.
- Macintosh and Mac are trademarks of Apple Computer, Inc., registered in the United States and other countries.
- CompactFlash is a registered trademark of SanDisk Corporation.
- MEMORY STICK and Memory Stick DUO are registered trademarks of Sony Corporation.
- SmartMedia is a registered trademark of Toshiba Corporation.
- MultiMediaCard is a trademark of the MultiMediaCard Association.
- xD-Picture Card is a trademark of Fuji Photo Film Corporation.
- SD, miniSD and SD Secure Digital are trademarks of SD Association.
- IrDA Feature Trademark is owned by the Infrared Data Association and used under license therefrom.
- Bluetooth is a trademark of Bluetooth SIG, Inc., U.S.A. and are licensed to Canon Inc.

Copyright ©2006 CANON INC.

All rights reserved. No part of this publication may be transmitted or copied in any form whatsoever without expressed written permission from Canon Inc.

Bluetooth ID: B02954

Table of Contents

Safety Precautions	4	9 Changing The Machine Settings	71
Reading The Document.....	9	Changing The Machine Settings	71
Symbols Used In This Guide	9	Print Settings	72
Legal Limitations On Use Of Your Product		Wireless Print Settings	72
And Use Of Images	9	Bluetooth Settings	73
1 Before Printing	10	Other Settings.....	73
Machine Parts And Their Functions.....	10	Language Selection.....	74
Turning The Machine ON/OFF	14	Reset Setting	74
Setting Documents	15	Save Settings	74
General Paper Guidelines	16	Load Settings.....	74
Recommended Paper.....	17	10 Routine Maintenance	75
Loading Paper	23	Replacing A FINE Cartridge	75
Changing The Print Settings.....	26	When Printing Becomes Faint Or	
2 Copying	31	Color Is Incorrect	84
Making Copies	31	Printing The Nozzle Check Pattern	85
Changing The Copy Settings.....	33	FINE Cartridge Cleaning	89
Using Useful Copy Functions	34	FINE Cartridge Deep Cleaning.....	90
3 Printing From A Memory Card	37	Aligning The FINE Cartridge.....	91
Using A Memory Card	37	Cleaning Your Machine	93
Printing Photograph.....	40	11 Troubleshooting	97
Other Useful Functions	46	An Error Message Is Displayed	
4 Reading From And Writing		On The LCD	98
To A Memory Card	50	Cannot See The Display Properly	
Setting Up The Card Slot As		On The LCD/Cannot See The Display	
The Memory Card Drive Of The Computer...50		On The LCD	99
5 Printing From Your Computer	52	Ink Does Not Come Out/Printing Is Blurred/ Colors Are Wrong/White Streaks/ Straight Lines Are Misaligned/ Cannot Print To End Of Job	99
Windows		Back Of Paper Is Smudged/ Paper Does Not Feed Properly/ Printed Surface Is Scratched.....	103
Printing With Windows.....	52	Paper Jams	106
Macintosh		Cannot Print Properly	
Printing With Macintosh.....	55	From A Photo Index Sheet	107
6 Scanning Images.....	58	An Unintended Language Is Displayed	
About Scanning Images.....	58	On The LCD.	107
Scanning Methods	58	Cannot Print Properly	
7 Printing Photographs Directly		From The Digital Camera	108
From A Digital Camera	61	Cannot Print Properly Through Wireless Communication.....	110
Printing Photographs Directly		Cannot Install The MP Driver	111
From A PictBridge-Compliant Device	61	Cannot Connect To PC Properly	112
8 Printing Photos From A		Problems With Scanning	113
Wireless Communication Device.....	65	An Error Message Appears	
Performing Infrared Communication.....	67	On The Screen	117
Performing Bluetooth Communication	69	Windows	
		For Windows Users	119
		If You Cannot Solve The Problem	120
		12 Appendix	121
		Printing Area.....	121
		Uninstalling The On-screen Manual	124
		Transporting The Machine.....	125

Specifications..... 126
Regulatory Information 129
 FCC Notice (U.S.A. Only)..... 129
 Canon U.S.A., INC.
 LIMITED WARRANTY (USA Only)..... 130
Users In Canada..... 133
 Customer Technical Supports 133
Index 134

Safety Precautions

Please read the safety warnings and cautions provided in this guide to ensure that you use your machine safely. Do not attempt to use the machine in any way not described in this guide.

 **Warning** You may cause an electric shock/fire or damage the machine if you ignore any of these safety precautions.

Location	Do not place the machine close to flammable solvents such as alcohol or thinners. If flammable substances come into contact with electrical parts inside the machine, it may result in fire or electrical shock.
Power supply	Never attempt to plug or unplug the machine from the power supply when your hands are wet. This may result in electrical shock.
	Always push the plug all the way into the power outlet. If the prongs of the power plug come into contact with metal objects, it may result in fire or electrical shock.
	Never damage, modify, stretch or excessively bend or twist the power cord. Do not place heavy objects on the power cord. These actions may cause electrical damage and result in fire or electrical shock.
	Never plug the machine into a power socket that is shared with other equipment (extension lead/cord, 2- or 3-way adapter, etc.). This may result in fire or electrical shock.
	Plug the machine into a standard 100-240 V AC, 50/60 Hz (depending on your local electrical requirements), two-prong* grounded outlet. Operate the machine only from the type of power source indicated on the machine's label or a fire, electrical shock, or malfunction may occur. If you are unsure of the type of power available, consult your local power company. * The shape of the plug and outlet may vary depending on the country of purchase.
	Do not allow the power cord to be near objects that emit heat. The outer cover of the power cord may melt resulting in fire or electrical shock.
	Never use the machine if the power cord is bundled or knotted. Knots in the cord may result in fire or electrical shock.
	If you detect smoke, unusual smells or strange noises around the machine, immediately unplug the machine at the power supply and contact your local authorized Canon dealer or the Canon help line. Using the machine in such conditions may result in fire or electrical shock.
	Periodically, unplug the machine and use a dry cloth to wipe off any dust or dirt collected on the plug and the power outlet.
	If the machine is placed at a location exposed to a lot of dust, smoke, or high humidity, the dust collected on the plug absorbs moisture and may cause insulation failure and fire.
Maintenance	Do not service the machine yourself except as specifically described in this guide. If further servicing is required, contact your local authorized Canon dealer or the Canon help line.
	When storing the machine, choose a location where the machine is not exposed to dust. Dust accumulation may prevent the machine from operating properly.
	Use a damp cloth to clean the machine. Never use flammable solvents such as alcohol, benzene or thinners. If flammable solvents come in contact with electrical components inside the machine, it could cause a fire or electrical shock.
	Always turn OFF the power and unplug the machine from the power outlet before cleaning the machine. If you leave ON or accidentally switch the machine ON while cleaning it, it may result in injury or damage the machine.

Handling	Do not attempt to disassemble or modify the machine. There are no user serviceable parts inside the machine. The machine contains high-voltage components. Never attempt any maintenance procedure not described in this guide. Incorrect maintenance procedures may damage the machine, or cause a fire or electrical shock.
	Do not drop paper clips, staples, or other metal objects inside the machine. Also do not spill water, liquid, or flammable substances inside the machine. If these items come into contact with high-voltage parts inside the machine, it may result in fire or electrical shock. If these items are dropped or spilled in the machine, turn OFF the power and unplug the power cord immediately with dry hands. Then contact your local authorized Canon dealer or the Canon help line.
	Do not use flammable sprays near the machine. This could cause a fire or electrical shock if the spray comes into contact with electrical components inside the machine.
	There are high-voltage components inside the machine. If you are looking inside the machine to clear paper jams etc., do not allow metal objects such as jewelry to come into contact with the inside of the machine. Contact may result in burns or electrical shock.
Others	When setting the machine near electric products with fluorescent lighting, separate the machine at least 5.9 inches (15 cm) from electric products equipped with fluorescent lighting. If you place it near to them, the machine may malfunction as a result of the noise emitted by the fluorescent lighting.
	When turning OFF the power, be sure to press [ON/OFF] and confirm that the Alarm Lamp has shut off. If you pull the power plug out of the wall outlet while the Alarm Lamp is on, the FINE Cartridge is not protected, and you may not be able to print later.

⚠ Caution

You may cause injury or damage the machine if you ignore any of these safety precautions.

Location	Do not block or cover the ventilation port or any openings on the machine with objects, as it may cause the inside of machine to overheat and cause a fire.
	Place the machine on a flat, stable, vibration-free surface that is strong enough to support its weight. If the machine topples over, it may result in injury. (For the weight of the machine, see "Appendix" on page 121.)
	Do not use or store the machine outdoors.
	Do not install the machine near devices that contain magnets or generate magnetic fields, such as speakers.
	To ensure proper ventilation, make sure the machine is approximately 4 inches (10 cm) away from walls and other equipment.
	Do not install the machine in a location that is very humid or dusty, in direct sunlight, outdoors, or close to a heating source. Installing in such a location may result in fire or electrical shock. To avoid the risk of fire or electrical shocks, install the machine in a location with an ambient temperature range of 41°F to 95°F (5°C to 35°C) and humidity of 10% to 90% (condensation free).
	Do not place the machine on a thick rug or carpet. If fibers or dust come inside the machine, it could cause a fire.

Power supply	<p>Never remove the plug by pulling on the cord. Pulling on the power cord may damage the cord and cause a fire or electrical shock.</p>
	<p>When turning OFF the power, be sure to press [ON/OFF] or unplug the machine. However, if the machine is unplugged during printing, the FINE Cartridge is not protected with the cap that prevents the ink from drying. This may affect the print quality of the machine when printing later.</p>
	<p>During electrical storms, turn OFF the power and disconnect the power cord from the power outlet.</p>
	<p>Do not use an extension cord as this may result in fire or electrical shock.</p>
	<p>Ensure that the area around the power outlet is kept clear at all times so you can easily unplug the power cord if necessary. Otherwise you will be unable to disconnect the power plug in case of an emergency, and it may result in fire or electrical shock.</p>
	<p>Never use a power supply source other than the one rated for the machine in the country where you purchased the machine as it may result in fire or electrical shock. The operating requirement of this machine is as follows: 100-240 V AC, 50/60 Hz (depending on local electrical requirements)</p>
	<p>Do not plug the machine into the same circuit as appliances such as an air conditioner, television, or copier. These devices generate electrical noise which may interfere with your machine's operation.</p>
	<p>Whenever you turn OFF the power and unplug the machine, wait at least five seconds before you plug it in again.</p>
	<p>Use only the power cord that came with the machine. Using a different power cord may cause electric leakage or damage to the machine.</p>
	<p>Turn OFF the power and unplug the machine in the following conditions:</p> <ul style="list-style-type: none"> ● When the power cord or plug is damaged or frayed. ● If liquid has spilled into the machine. ● If the machine has been exposed to rain or water. ● If the machine does not operate normally when you have followed the instructions in the guides included with your machine. ● If the machine does not operate normally when you have followed the instructions provided in "Troubleshooting" on page 97. ● If the machine has been dropped or damaged. ● If the machine exhibits a distinct change in performance, indicating a need for servicing.
	<p>Turn OFF the power and disconnect the power cord if the machine will not be used for a long period such as during holidays.</p>
	<p>The socket-outlet shall be installed near the equipment and shall be easily accessible.</p>

Handling

Close the Document Cover gently to avoid catching your hand. Failing to do so may result in personal injury.

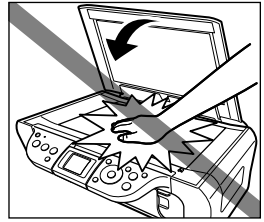

Do not press down hard on the Document Cover when using the Platen Glass to scan thick books. This may damage the Platen Glass and Document Cover and/or result in personal injury.

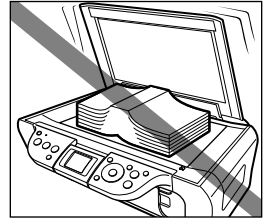

Do not place the following objects on top of the machine. If such objects come into contact with internal electrical components, the machine may short-circuit, resulting in fire or electrical shock.

- Metal objects such as jewelry and watches
 - Containers of water or other liquids such as glasses, vases, or pot plants
- If water does spill inside the machine, turn OFF the power immediately by pressing the [ON/OFF], and disconnect the power cord. Then, contact your local authorized Canon dealer or the Canon help line.

Do not touch the high-voltage electrical parts as this may result in electrical shock.

Do not place heavy objects on top of the machine as these may topple over and result in injury.

When removing paper jammed in the machine, be careful not to get ink on your hands or clothing. If ink gets on your hands or clothing, wash them soon in running water. If you use hot water, the ink may adhere and become difficult to remove.

After printing, do not touch the electrical contacts of the FINE Cartridge. They will be hot and may result in burns or electrical shock.

Do not subject the machine to strong physical shock or vibration. This can damage the machine's components.

Before moving the machine, turn OFF the power and unplug the machine.

When moving the machine, carry the machine at both ends.

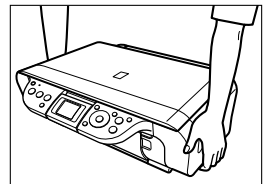

A distinct change in performance may indicate a need for servicing.

Do not insert your hands into the machine while it is printing.
Parts inside the machine are moving and this may result in injury.

Do not turn the machine upside down.
Ink may leak out and stain clothing or the surrounding area.

Adjust only those controls that are covered by the instructions in the guides since improper adjustment of other controls may result in damage and require extensive repair by a qualified technician to restore the product to normal operation.

When storing or transporting the machine, do not tilt it, stand it on its side, or turn it upside down. Doing so may cause ink to leak out.

FINE Cartridges (Ink Cartridges)	For safety reasons, store FINE Cartridges (Ink Cartridges) out of the reach of small children. If a child ingests any ink, consult a doctor immediately.
	Do not shake FINE Cartridges (Ink Cartridges). Ink may leak out and stain clothing or the surrounding area.
	Never touch the nozzle and the gold terminal.

Reading The Document

Symbols Used In This Guide

Please read the list below of symbols used in this guide. The following symbols are used to indicate important instructions. Be sure to obey these instructions.

 **Warning**

Indicates a warning concerning operations that may lead to death or injury to persons if not performed correctly. In order to use the machine safely, always pay attention to these warnings.

 **Caution**

Indicates a caution concerning operations that may lead to injury to persons or damage to property if not performed correctly. In order to use the machine safely, always pay attention to these cautions.

 **Important**

Indicates operational warnings and restrictions. Be certain to read these items to operate the machine correctly, and to avoid damage to the machine.

 **Note**

Indicates notes for operation or additional explanations. Reading these is highly recommended.

 **Windows**

Read this when the machine is connected to a Windows system.

 **Macintosh**

Read this when the machine is connected to a Macintosh system.

Legal Limitations On Use Of Your Product And Use Of Images

It may be unlawful to make copies of, scan, print or use reproductions of the following documents. The list provided is non-exhaustive. When in doubt, check with a legal representative in your jurisdiction.

- Paper money
- Money orders
- Certificates of deposit
- Postage stamps (canceled or uncanceled)
- Identifying badges or insignias
- Selective service or draft papers
- Checks or drafts issued by governmental agencies
- Motor vehicle licenses and certificates of title
- Traveler's checks
- Food stamps
- Passports
- Immigration papers
- Internal revenue stamps (canceled or uncanceled)
- Bonds or other certificates of indebtedness
- Stock certificates
- Copyrighted works/works of art without permission of copyright owner

Chapter 1

Before Printing

Machine Parts And Their Functions

This section provides the name and location of the main components of this machine, and also describes their functions.

■ Machine

● Exterior

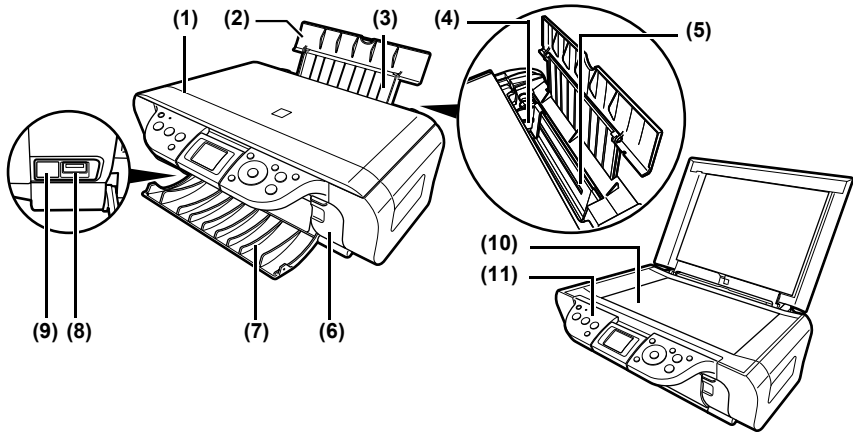

- (1) Document Cover
Covers the Platen Glass. Open this cover when loading a document on the Platen Glass.
- (2) Paper Support
Supports paper loaded in the Auto Sheet Feeder. Open it before loading paper.
- (3) Paper Support Extension
Supports paper loaded in the Auto Sheet Feeder. Pull it out before loading paper.
- (4) Paper Guide
When loading paper, ensure the left edge of the paper just touches this guide.
- (5) Auto Sheet Feeder
Load paper here. Paper feeds automatically, one sheet at a time.
- (6) Card Slot Cover
Covers the Card Slots. Open this cover when inserting a memory card into the Card Slots.
- (7) Paper Output Tray
Printouts are output to this tray. Open the tray before you start copying or printing. When not being used, keep it closed in the machine.
- (8) Direct Print Port
Used to connect a PictBridge compliant device or the optional Bluetooth unit* to the machine when printing images directly from the device.
- (9) IrDA Port
Receives photo data sent from the mobile phone through infrared communication.
- (10) Platen Glass
Used to load a document to be processed.

(11) Operation Panel

Displays the operational status of the machine. It is also used to change or check the settings of each function. For details, see "Operation Panel" on page 12.

* The Bluetooth unit is not available to some regions due to the law of the countries or the regulations. For details, contact your local Canon service representatives.

● Rear view and interior

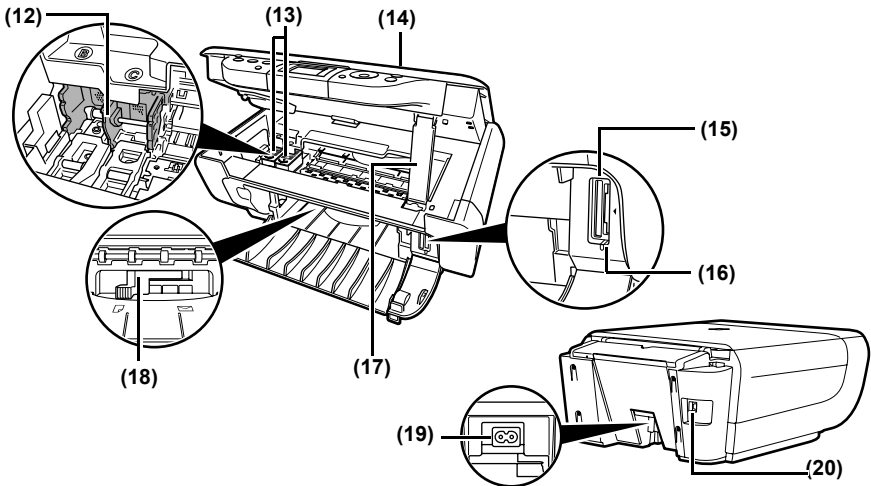

(12) FINE Cartridge Holder

Install the FINE Cartridges here.

(13) FINE Cartridges (Ink Cartridges)

Replaceable cartridge that comprises an integrated Print Head and ink tank.

FINE Cartridges are available in two types, Color (on the right) and Black (on the left).

(14) Scanning Unit

Used to scan a document.

(15) Card Slots

Insert a memory card or card adapter containing a memory card into these slots for photo printing. The machine is equipped with two kinds of Card Slot.

(16) Access Lamp

Lights when a memory card is inserted into the Card Slots. This lamp flashes while the machine is reading data from the memory card.

(17) Scanning Unit Support

Used to hold the Scanning Unit being opened.

(18) Paper Thickness Lever

Used to adjust the gap between the FINE Cartridge and surface of the printing paper.

Move the lever to the correct position for the media being used.

(19) Power Connector

Used to connect the power cord to the machine.

(20) USB Port

Used to connect a computer to the machine when printing from or scanning to the computer.

⚠ Important

While the machine is printing from or scanning images to the computer, or the computer is in the sleep mode or standby mode, do not disconnect and connect the USB cable.

■ Operation Panel

This section describes the buttons on the Operation Panel, and their functions and locations.

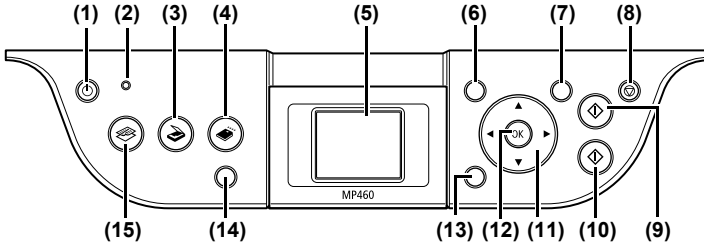

- (1) [ON/OFF] Button
Turns the machine ON and OFF. Before turning ON the machine, make sure the Document Cover is closed.
- (2) Alarm Lamp
Lights if an error occurs, or when the paper or ink runs out.
- (3) [SCAN] Button
Switches the machine to scan mode. In scan mode, the machine scans a document to your computer according to the operations selected. To use this button, the machine must be connected to a computer.
- (4) [MEMORY CARD] Button
Switches the machine to Memory Card mode.
- (5) LCD (Liquid Crystal Display)
Displays messages, menu selections, and the operational status.
- (6) [Menu] Button
Accesses the settings to customize operation of your machine.
The power cannot be turned OFF with [ON/OFF] when the machine is operating.
Your machine performs a print head cleaning every time you plug in the machine. This ensures optimum print quality but also consumes a small amount of ink during the cleaning process.
- (7) [Settings] Button
Use to configure the page size, media type and image correction settings.
- (8) [Stop/Reset] Button
Cancels operations and returns the machine to standby mode.
- (9) [Black] Button
Starts black & white copying.
- (10) [Color] Button
Starts color copying, color photo printing.
- (11) [▲][▼][◀][▶] Buttons
Scroll through menu selections, and increase or decrease the number of copies or the image file number.
- (12) [OK] Button
Selects an item from the menu, and confirms selections. Restores the machine to normal operation if there is an error while printing or if the paper jams. Also, use this button to accept a displayed message.
- (13) [Back] Button
Returns to the previous screen.

- (14) [Photo Index Sheet] Button
Switches the machine to Photo Index Sheet mode.
- (15) [COPY] Button
Switches the machine to copy mode.

Turning The Machine ON/OFF

- 1 Press [ON/OFF] to turn the machine ON and OFF. Before turning ON the machine, make sure the Document Cover is closed.

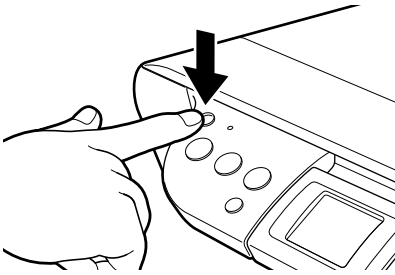

Important

- Always press [ON/OFF] before disconnecting the power cord. This ensures the FINE Cartridge is covered to prevent it from drying out.
- If the machine is not used for an extended period of time, we recommend making black & white and color prints/copies or performing FINE Cartridge cleaning about once every month to prevent degradation of the FINE Cartridge. (See page 89)
- The FINE Cartridge has many nozzles in order to produce high-definition prints. In the same way that the tip of a felt-tip or marker pen will naturally dry out over time and become unusable even with the cap in place, the nozzles might become clogged. Periodically printing or performing FINE Cartridge cleaning can help to prevent this kind of clogging.

Note

- The power cannot be turned OFF with [ON/OFF] while the machine is operating.
- Your machine performs a FINE Cartridge cleaning every time you plug in the machine. This ensures optimum print quality but also consumes a small amount of ink during the cleaning process. We recommend turning OFF the power with [ON/OFF].
- The LCD goes out if the machine is not operated for 5 minutes. Press any button to restore the display. You cannot change the period before the LCD goes out.

Setting Documents

■ Document Requirements

The documents you load on the Platen Glass for copying or scanning must meet these requirements:

Document Type	<ul style="list-style-type: none">● All types of paper documents● Photographs● Books, catalogs or magazines
Size (W x L)	Max. 8 1/2 in. x 11 3/4 in. (216 mm x 297 mm)
Thickness	Max. 3/4 in. (20 mm)

■ Loading Documents

To copy or scan a document, set it on the Platen Glass.



Note

Make sure any glue, ink, or correction fluid on the document is completely dry before loading.

1

Lift the Document Cover.

2

Load your document.

- Place your document face down on the Platen Glass.
- Align the upper left corner of your document with the alignment mark on the lower right corner of the Platen Glass.

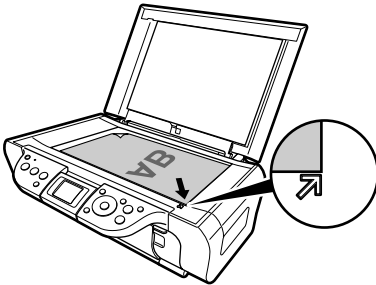

Important

- Do not place any objects weighing more than 4.4 lb / 2 kg on the Platen Glass.
- Do not press or put weight on the original with pressure exceeding 4.4 lb / 2 kg. Doing so may cause the scanner to malfunction or the Platen Glass to break.



Note

The machine cannot scan the area within approximately 1/16 in. (2 mm) of the front and right edges of the Platen Glass.

3 Gently close the Document Cover.



Note

Thick documents (Max. 3/4 in./20 mm), such as books, can also be scanned.

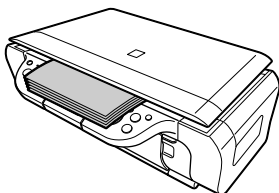

General Paper Guidelines

■ Paper Types You Cannot Use

Do not use:

- Folded, creased, curled, or wrinkled paper
- Envelopes with double flaps, or with pressure seals
- Moist paper
- Paper with holes (e.g. punched holes)
- Very thin paper (less than 17 lb. or 64 g/m²)
- Very thick paper (more than 28 lb. or 105 g/m²) other than Canon genuine paper
- Postcards with photographs or stickers adhered to them
- Envelopes made with embossed or treated surfaces

■ Handling Paper

- Hold the paper as close as possible to its edges and try not to touch the print surface. The print quality will deteriorate if the print surface is damaged or becomes dirty.
- Do not touch the print surface until the ink has dried.
- Some paper may curl and the print surface may smudge if you have used a large amount of ink for printing. Paper that tends to curl is not recommended for printing photographs or graphics. Use it for printing mainly text.
- If the paper is curled, uncurl (flatten) it before printing.
- Place the paper back into its packet when not using it, and store out of direct sunlight in a place where the temperature and humidity are low.
- If the printed area is traced with a highlight pen or paint-stick or stained with water or sweat, ink may blur.

Recommended Paper

The following paper is recommended for use with your machine. Please be sure to follow the guidelines and meet the requirements when loading paper in the Auto Sheet Feeder.

Paper Type	Load Limit	Paper Thickness Lever Position	Printer Driver Setting For [Media Type]
Plain paper	Approx. 100 sheets (17 lb. or 64 g/m ²)	Left	[Plain Paper]
Envelopes	Approx. 10 envelopes	Right	[Envelope]

■ Canon Genuine Media

Canon recommends that you use genuine Canon paper to insure optimal print quality.

Paper Type	Model	Load Limit	Paper Thickness Lever Position	Printer Driver Setting For [Media Type]
Super White Paper	SW-201	Approx. 100 sheets (Letter/A4)	Left	[Plain Paper]
High Resolution Paper	HR-101N	Approx. 80 sheets (Letter/A4)	Left	[High Resolution Paper]
Glossy Photo Paper	GP-401/ GP-501	10 sheets (Letter/A4) 20 sheets (4" x 6"/Credit Card)	Left	[Glossy Photo Paper]
Matte Photo Paper	MP-101	10 sheets (Letter/A4) 20 sheets (4"x6")	Left	[Matte Photo Paper]
Photo Paper Plus Double Sided	PP-101D	1 sheet (Letter/A4/5" x 7")	Left	[Photo Paper Plus Double Sided]
Photo Paper Plus Glossy	PP-101	10 sheets (Letter/A4/5" x 7") 20 sheets (4" x 6")	Left	[Photo Paper Plus Glossy]
Photo Paper Plus Semi-gloss	SG-101/ SG-201	10 sheets (Letter/A4) 10 sheets (8" x 10") ^{*1} 20 sheets (4" x 6")	Left	[Photo Paper Plus Glossy]
Photo Paper Pro	PR-101	10 sheets (Letter/A4/8" x 10") 20 sheets (4" x 6"/Wide)	Left	[Photo Paper Pro]
Photo Stickers	PS-101	1 sheet	Left	[Photo Paper Plus Glossy]
T-Shirt Transfers	TR-301	1 sheet	Right	[T-Shirt Transfers]

*1 SG-201 only

- If the paper does not feed properly, fan the sheets prior to loading them (up to 10) in the Auto Sheet Feeder. Fanning the sheets will prevent them from sticking together.

■ Selecting The Correct Paper

This section describes the characteristics and intended use of each paper applicable to this machine. Refer to this section and select the paper most suitable for your purpose of printing.

Paper Type	Size	Purpose	Guidelines And Restrictions
Plain paper	Letter (8 1/2 in. x 11 in./ 215.9 mm x 279.4 mm) Legal (8 1/2 in. x 14 in./ 215.9 mm x 355.6 mm) A4 (8 1/4 in. x 11 3/4 in./ 210 mm x 297 mm) A5 (5 7/8 in. x 8 1/4 in./ 148 mm x 210 mm) B5 (7 1/8 in. x 10 1/8 in./182 mm x 257 mm)	Printing from your computer/photo printing/copying	17 lb.–28 lb. (64 g/m ² –105 g/m ²) The machine supports the paper sizes shown on the left in portrait orientation. You can use regular copier paper, cotton bond paper, or typical letterhead. Your machine does not require special inkjet paper. Legal-size paper can only be used when printing from your computer. We do not recommend using plain paper for photo printing.
Envelopes	US Commercial No. 10 (9 1/2 in. x 4 1/8 in./241 mm x 105 mm) European DL (8 5/8 in. x 4 3/8 in./220 mm x 110 mm)	Printing from your computer	You may be able to load other envelopes, but Canon cannot guarantee consistent performance. Do not use the following types of envelopes since they may cause problems: Envelopes with windows, holes, perforations, cutouts, double flaps, pressure seals, and peel-off sealing strips. Envelopes made with embossed or treated surfaces. Sealed envelopes. Envelopes with letters enclosed. Remove each envelope from the Paper Output Tray as soon as it is printed.

■ Canon Genuine Media

Canon recommends that you use genuine Canon paper to insure optimal print quality.

Paper Type	Size	Purpose	Guidelines And Restrictions
High Resolution Paper	Letter (8 1/2 in. x 11 in./ 215.9 mm x 279.4 mm) A4 (8 1/4 in. x 11 3/4 in./ 210 mm x 297 mm)	Printing from your computer/ photo printing/ copying	This type of paper provides better color reproduction than plain paper. It is suitable for printing business documents that feature graphics and for photographs. Load the paper with the whiter side facing up. If the paper curls, remove each sheet as it is delivered in the Paper Output Tray.
Glossy Photo Paper	Letter (8 1/2 in. x 11 in./ 215.9 mm x 279.4 mm) A4 (8 1/4 in. x 11 3/4 in./ 210 mm x 297 mm) 4" x 6" (4 in. x 6 in./ 101.6 mm x 152.4 mm) Credit Card (54 x 86 mm)	Printing from your computer/photo printing/copying	This paper is thicker than High Resolution Paper and has a glossy surface to produce near photographic quality printouts. By using borderless printing, you can print without any white borders. Do not touch the printing surface until the ink has dried. Load the paper with the whiter side facing up. Do not use the loading support sheet included with this paper. If the ink takes a long time to dry, remove each sheet as soon as it is printed.
Matte Photo Paper	Letter (8 1/2 in. x 11 in./ 215.9 mm x 279.4 mm) A4 (8 1/4 in. x 11 3/4 in./ 210 mm x 297 mm) 4" x 6" (4 in. x 6 in./ 101.6 mm x 152.4 mm)	Printing from your computer/photo printing	This paper is thick and has a matte finish. This is matte water-resistant paper and provides superior color reproduction. It is suitable for a variety of printing purposes such as paper crafts, calendars and matte photographs. By using borderless printing, you can print without any white borders. Load the paper with the whiter side facing up. Do not touch the printing surface until the ink has dried. Remove each sheet from the Paper Output Tray as soon as it is printed.

Paper Type	Size	Purpose	Guidelines And Restrictions
Photo Paper Plus Double Sided	Letter (8 1/2 in. x 11 in./ 215.9 mm x 279.4 mm) A4 (8 1/4 in. x 11 3/4 in./ 210 mm x 297 mm) 5" x 7" (5 in. x 7 in./ 127.0 mm x 177.8 mm)	Printing from your computer/photo printing	This is a thick paper with a glossy water-resistant coating and provides superior color reproduction. It is ideal for printing high-quality photographs. Both sides of the paper can be printed on. Load one sheet at a time in the Auto Sheet Feeder when manually making double-sided prints. Remove each sheet from the Paper Output Tray as soon as it is printed.
Photo Paper Plus Glossy	Letter (8 1/2 in. x 11 in./ 215.9 mm x 279.4 mm) A4 (8 1/4 in. x 11 3/4 in./ 210 mm x 297 mm) 4" x 6" (4 in. x 6 in./ 101.6 mm x 152.4 mm) 5" x 7" (5 in. x 7 in./127 mm x 177.8 mm)	Printing from your computer/photo printing	This is a thick paper with a glossy water-resistant coating and provides superior color reproduction. It is ideal for printing high-quality photographs. By using borderless printing, you can print without any white borders. Load the paper with the glossy side facing up. Remove each sheet from the Paper Output Tray as soon as it is printed.
Photo Paper Plus Semi-gloss	Letter (8 1/2 in. x 11 in./ 215.9 mm x 279.4 mm) A4 (8 1/4 in. x 11 3/4 in./ 210 mm x 297 mm) 4" x 6" (4 in. x 6 in./ 101.6 mm x 152.4 mm) 8" x 10" (8 in. x 10 in./ 203.2 mm x 254.0 mm)	Printing from your computer/photo printing	This is a matt water-resistant paper and provides superior color reproduction. It is ideal for printing high-quality photographs. By using borderless printing, you can print without any white borders. Load the paper with the glossy side facing up. Remove each sheet from the Paper Output Tray as soon as it is printed.

Paper Type	Size	Purpose	Guidelines And Restrictions
Photo Paper Pro	Letter (8 1/2 in. x 11 in./ 215.9 mm x 279.4 mm) A4 (8 1/4 in. x 11 3/4 in./ 210 mm x 297 mm) 4" x 6" (4 in. x 6 in./ 101.6 mm x 152.4 mm) Wide (4 in. x 7.1 in./ 101.6 mm x 180.6mm) 8" x 10" (8 in. x 10 in./ 203.2 mm x 254.0 mm)	Printing from your computer/photo printing/copying	<p>This is a thick paper with a treated surface that enhances gloss and provides superior color reproduction and good lightfastness.</p> <p>It is ideal for printing high-quality photographs.</p> <p>By using borderless printing, you can print without any white borders.</p> <p>For 4" x 6" paper, by printing the image beyond the perforations, you can then trim the borders to produce a photograph without any white borders. Do not trim the borders before printing.</p> <p>Load the paper with the glossy side facing up.</p> <p>For 4" x 6" cards, remove the cards from the Paper Output Tray before the count reaches 20.</p> <p>For other than 4" x 6" cards, remove the paper from the Paper Output Tray before the count reaches 10.</p> <p>For additional information on Photo Paper Pro, see page 22.</p>
Photo Stickers	4" x 6" (4 in. x 6 in./ 101.6 mm x 152.4 mm)	Printing from your computer/copying	<p>This is a peel-and-stick sheet that allows you to make original photo stickers using your own photographs. On each sheet, you can print 16 photo stickers with excellent printing qualities.</p> <p>Load only one sheet at a time with the glossy side up. Printing on the reverse side can stain the inside of the machine or your clothes.</p> <p>Place the sheet in portrait orientation in such a manner that the top margin is larger than the bottom margin. For more information, refer to the instructions on the back of the sheet package.</p> <p>If a sheet is curled, uncurl (flatten) it before loading.</p> <p>Remove each sheet from the Paper Output Tray as soon as it is printed. Do not use a sheet if any stickers are becoming unstuck or are missing from the sheet.</p>

Paper Type	Size	Purpose	Guidelines And Restrictions
T-Shirt Transfers	A4 (8 1/4 in. x 11 3/4 in./ 210 mm x 297 mm)	Printing from your computer	<p>This paper is used to produce iron-on transfers.</p> <p>Use mirror printing to print the image onto the T-Shirt Transfer.</p> <p>T-Shirt Transfers can only be used when printing from your computer.</p> <p>Load the paper with the side that does not have green lines facing up.</p> <p>If the T-Shirt Transfer is curled, flatten it by curling it in the opposite direction.</p> <p>The T-Shirt Transfer should be used as soon as it is printed.</p> <p>Refer to the manuals supplied with the T-Shirt Transfer for details on how to use this paper.</p>

● Photo Paper Pro Guidelines

- Do not touch the print surface until the ink is dry (approx. 30 minutes). Colors in dark images may appear indistinct at first, but will become clearer after approx. 30 minutes.
- Images may smudge if you place them in an album before the ink is completely dry. It is recommended that you allow the ink to dry for 24 hours.
- Do not attempt to dry the ink with a hair dryer or by exposing printouts to direct sunlight.
- Do not store or display printouts in hot, damp, or humid conditions. Never expose them to heat or direct sunlight.
- Store printouts in photo albums, photo frames, or presentation binders to protect them from direct exposure to air or sunlight.
- Do not mount printouts in an adhesive-type album as you may not be able to remove them.
- Be aware that some types of clear plastic folders and albums may cause the edges of the paper to turn yellow.

Loading Paper

■ Loading Paper

Follow this procedure:

- 1 Open the Paper Support (1), then pull out the Paper Support Extension (2).

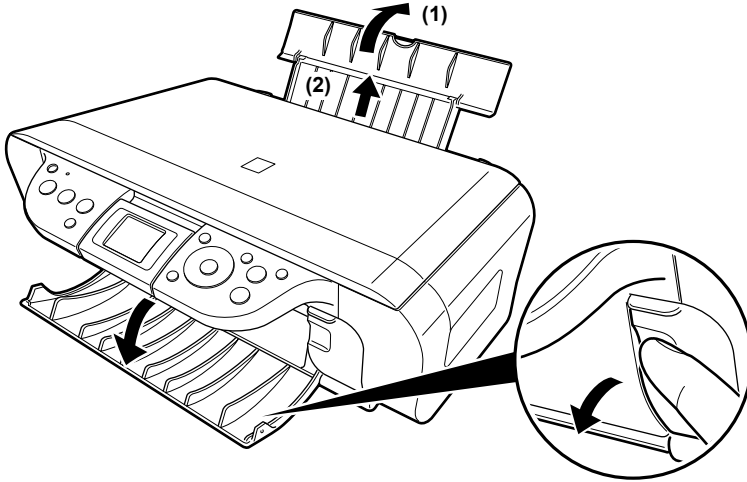

- 2 Place a stack of paper (print side up) in the Auto Sheet Feeder (1), pinch the Paper Guide (A) and adjust it to the left side of the stack (2).

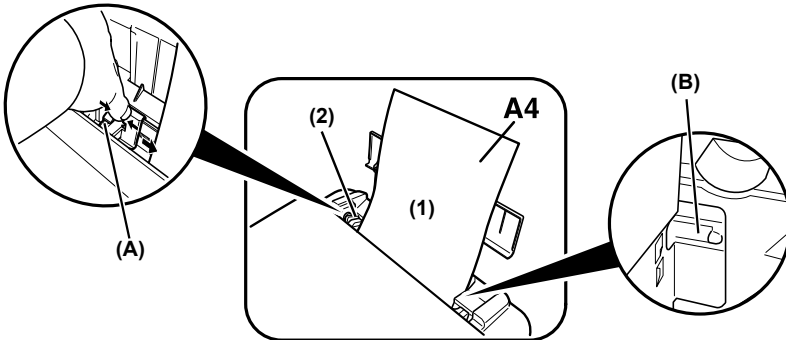

- Set the Paper Thickness Lever to the correct position for the paper. (See page 17)

Note

Set the Lever to the left for most paper. When the Lever is set to the right, the confirmation message appears before the machine starts printing.

Important

Make sure the stack does not exceed the Load Limit Mark (B).

■ Loading Envelopes

Follow this procedure:

- 1 Open the Paper Support, then pull out the Paper Support Extension.
- 2 Prepare the envelopes for loading.

⚠ Important

- Press down firmly on the edges of the envelopes to make the folds crisp. Also, press firmly on the area that corresponds to the edges of the back flap.

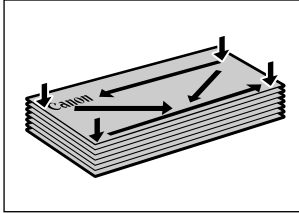

- Remove any curling by holding the edges diagonally and bending them gently.

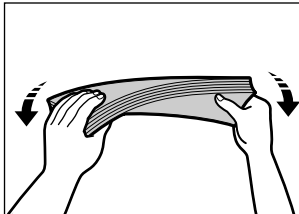

- If the edges of the envelope are inflated or curled, place the envelope on a flat surface. With a pen, press down while moving it from the center toward the edges of the envelope.

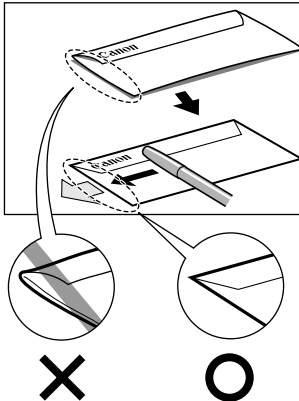

- Ensure that no curl or puff exceeds 1/8 in. (3 mm).

- 3** Place the stack of envelopes (print side up) in the Auto Sheet Feeder (1), pinch the Paper Guide (A) and adjust it to the left side of the stack (2).

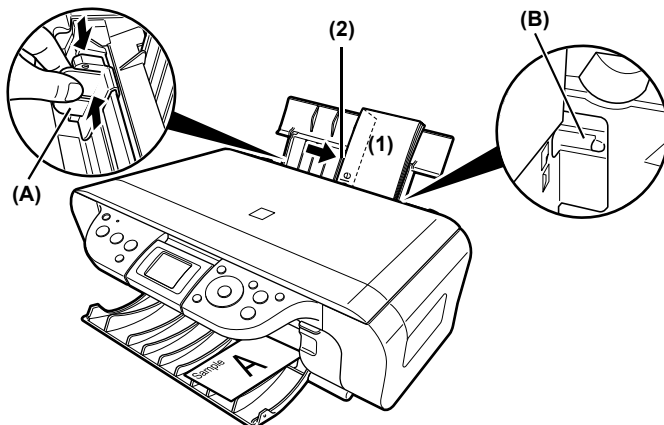

- Load the envelopes in the Auto Sheet Feeder with the short side down.
- Set the Paper Thickness Lever to the right.

⚠ Important Make sure the stack does not exceed the Load Limit Mark (B).

Changing The Print Settings

This section describes the setting items that can be specified in the Settings screen.

■ To Change Print Settings

You can change the print settings such as page size, media type, bordered or borderless print, etc.

● How to change the Settings screen

This section describes the steps to specify the page size for Memory card mode to <4" x 6" (101.6 x 152.4)> as an example. For information on each item, see "Print Setting Items" on page 28.

1 Press [Settings].

(1) The Settings screen is displayed.

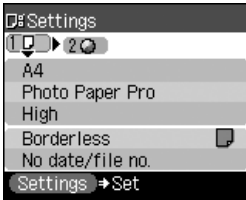

2 Select the Setting tab.

(1) Use [◀] or [▶] to select the Setting tab.
Select tab 1.

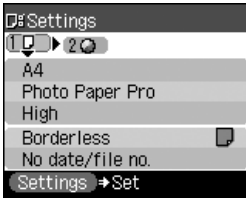

3 Select the setting item.

- (1) Use [▲] or [▼] to select the setting item.
Select <A4> here.

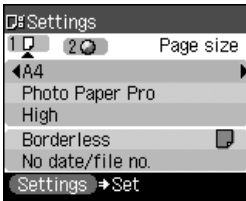

4 Change the setting.

- (1) Use [◀] or [▶] to change the setting.
Change to <4" x 6" (101.6 x 152.4)> here.

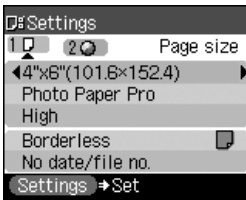

5 Complete setting.

- (1) Press [Settings].
Return to the Card menu.

■ Print Setting Items

Each tab contains the following setting items. To change the tab, use **[▲]** to select the tab and use **[◀]** or **[▶]**.



Note

Depending on the functions specified in the Copy or Memory card mode, some setting items cannot be specified in combination.

● Copy mode

This section describes the Settings screen for Copy mode.

Tab 1

You can specify the paper settings for printing or print quality.

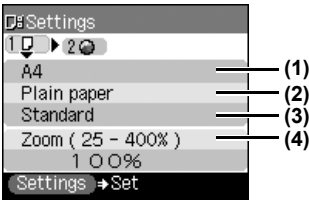

(1) You can specify the page size.

8.5" x 11" (215.9 x 279.4), A4, B5, A5, 4" x 6" (101.6 x 152.4), 5" x 7" (127.0 x 177.8), Credit card



Note

Some of these are not available depending on the country of purchase.

(2) You can specify the media type.

Plain paper, Photo Paper Pro, Photo Plus Glossy, Matte Photo Paper, Glossy Photo Paper

(3) You can adjust image quality according to the documents you want to copy.

Fast, Standard, High



Note

- <Fast> can be selected when <Plain paper> is selected as the media type.
- When using <Fast> with media type set to <Plain paper>, if the quality is different from that expected, select <Standard> or <High> and try copying again.
- Select <High> to copy in grayscale. Grayscale renders tones in a range of grays instead of black or white.

(4) You can specify the reduction or enlargement method.

Same magnification, Preset ratio, Zoom (25 - 400%), Fit-to-page

Tab 2

You can specify Auto intensity.

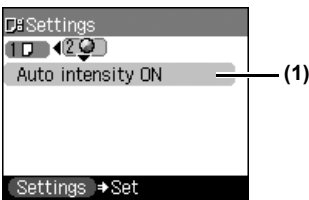

(1) You can specify if Auto intensity is performed.

Auto intensity ON/Auto intensity OFF

● Memory card mode

This section describes the Settings screen for Memory card mode.

Tab 1

You can specify the settings such as the paper, bordered/borderless, and Date/file number.

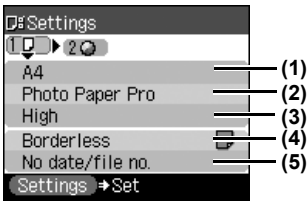

- (1) Select the page size.
8.5" x 11" (215.9 x 279.4), A4, 4" x 6" (101.6 x 152.4), 5" x 7" (127.0 x 177.8), Credit card

Note Some of these are not available depending on the country of purchase.

- (2) Select the media type.
Plain paper, Photo Paper Pro, Photo Plus Glossy, Matte Photo Paper, Glossy Photo Paper
- (3) Select the printing quality.
Standard/High
- (4) Select bordered or borderless print.
Bordered/Borderless

Note <Bordered> is selected automatically when the media type is set to <Plain paper>. You cannot select <Borderless>.

- (5) Select whether to print the shooting date, file number, or not.
No date/file no., Print date only, Print file no. only, Print date & file no.

Tab 2

Allows you to optimize photos with the functions below.

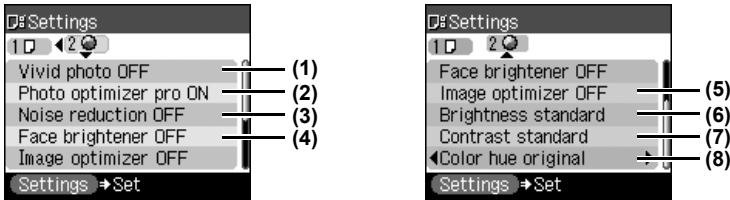

- (1) Activate/deactivate Vivid photo function.
This function makes green and blue more lively.
Vivid photo ON/Vivid photo OFF
- (2) Activate/deactivate the Photo optimizer pro function.
This function automatically optimizes brightness and tone of a photo.
Photo optimizer pro ON/Photo optimizer pro OFF
- (3) Activate/deactivate the Noise reduction function.
This function reduces the noise on blue areas like the sky as well as on black areas.
Noise reduction ON/Noise reduction OFF
- (4) Activate/deactivate Face brightener function.
This function brightens a darkened face on the photo taken against the light.
Face brightener ON/Face brightener OFF
- (5) Choosing <Image optimizer ON> enables you to correct and smooth the jagged contours for printing.
Image optimizer ON/Image optimizer OFF
- (6) Adjust brightness.
Brightness +2, Brightness +1, Brightness Standard, Brightness -1, Brightness -2
- (7) Adjust contrast.
Contrast +2, Contrast +1, Contrast Standard, Contrast -1, Contrast -2
- (8) Adjust color hue.
Color hue red +2, Color hue red +1, Color hue original, Color hue yellow +1, Color hue yellow +2

Chapter 2

Copying

Making Copies

This section describes the basic procedure to make copies.

1 Prepare for copying.

- (1) Press [ON/OFF] to turn ON the machine.
- (2) Press [COPY].
- (3) Load the paper in the Auto Sheet Feeder.
See "Loading Paper" on page 23.

2 Start copying.

- (1) Check the page size and media type.

Note Press [Settings] to check or change the page size, media type, or other settings. See "Changing The Print Settings" on page 26.

- (2) Use [▲] or [▼] to specify the number of copies.

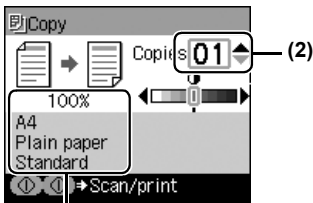

(1)

The following information is displayed as well.

Intensity: Pressing [◀] decreases the intensity, and pressing [▶] increases the intensity.

You can also use the auto intensity. See "Print Setting Items" on page 28.

- (3) Load the document on the Platen Glass.

Note For information on the types and conditions of documents which you can copy, see "Loading Documents" on page 15.

- (4) Press [Color] for color copying, or [Black] for black & white copying.
The machine starts copying.

Note To cancel copying, press [Stop/Reset].

■ Reducing Or Enlarging A Copy

You can reduce or enlarge copies.

1 Prepare for copying.

See page 31

2 Select the reduction/enlargement method.

The example below assumes that you will select <Zoom (25 - 400%)>.

(1) Press [Settings].

(2) Use [◀] or [▶] to select <Tab 1>.

(3) Use [▲] or [▼] to select <Magnification>, and use [◀] or [▶] to select <Zoom (25 - 400%)>.

Specify the custom copy ratio for reducing or enlarging copies.

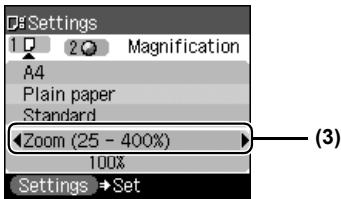

Besides <Zoom (25 - 400%)>, you can also choose from the following reduction/enlargement methods.

<Same magnification>: Copies in the same size as an original.

<Preset ratio>: Preset ratios are convenient when changing between standard page sizes, for example, when reducing A4 to A5, or enlarging B5 to A4.

<Fit-to-page>: You can automatically reduce or enlarge the document to fit the size of the paper which are loaded in the Auto Sheet Feeder.

(4) Press [▼] to move the cursor down, and use [◀] or [▶] to select the setting value. Holding down [◀] or [▶] steps through the values faster.

Note When you choose <Fit-to-page>, the document size may not be detected correctly depending on the document. In that case, choose <Preset ratio> or <Zoom (25 - 400%)>.

3 Finalize your selection.

Press [Settings] to return to the Copy standby screen.

4 Start copying.

See page 31

Changing The Copy Settings

You can change the copy settings such as the page size, media type, or print quality.

For details on changing the copy settings and setting items, see “Changing The Print Settings” on page 26.

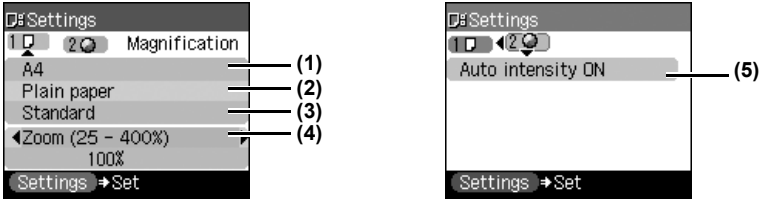

- (1) You can specify the page size.
- (2) You can specify the media type.
- (3) You can adjust the image quality for the document to be copied.
- (4) You can specify the reduction/enlargement method.
See “Reducing Or Enlarging A Copy” on page 32.
- (5) You can specify if auto intensity is performed.
Specifying <Auto intensity ON> automatically changes the icon above the intensity slide bar on the LCD to <Auto>.

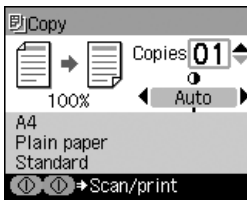

⚠ Important

Even while <Auto intensity ON> is selected, you can change the intensity by pressing [◀] or [▶]. Move the cursor to the center of the slide bar to enable auto intensity again.

Using Useful Copy Functions

■ Special Copy

You can copy in various layouts.

- 1 Prepare for copying.
See "Start copying." on page 31
- 2 Select the copy menu.

- (1) Press [Menu].
- (2) Use [◀] or [▶] to select <Special copy>, then press [OK].
The Special copy screen is displayed.

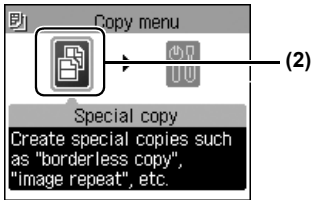

● Creating Stickers (Sticker Copy)

You can easily make stickers from 4" x 6" (101.6 x 152.4 mm) photos or graphics using Canon sticker paper.

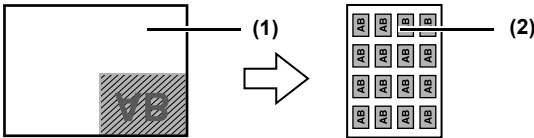

- (1) Platen Glass (place document face down)
- (2) 16 stickers

Procedure:

- (1) Display the Special copy screen.
See "Special Copy" on page 34.
- (2) Use [◀] or [▶] to select <Sticker copy>, then press [OK].
- (3) Use [◀] or [▶] to select <Stickers x16>, then press [OK].
- (4) Follow the on-screen instructions to load the document on the Platen Glass, then press [OK].
- (5) Specify the necessary items.
See "Changing The Print Settings" on page 26.
- (6) Press [Color] for color copying, or [Black] for black & white copying.



Note

- You can only load one sheet of stickers at a time in the Auto Sheet Feeder when using this function.
- You cannot specify the page size, media type, or Magnification when using this function.
- The Quality is fixed to <High>. You cannot select other than <High>.

● Copying Without Borders (Borderless Copy)

This feature enables you to copy the images so that they fill the entire page without borders.

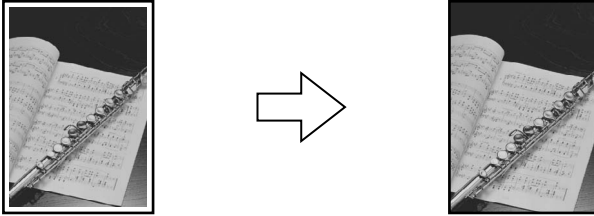

Procedure:

- (1) Display the Special copy screen.
See "Special Copy" on page 34.
- (2) Use [◀] or [▶] to select <Borderless copy>, then press [OK].
- (3) Specify the necessary items.
See "Changing The Print Settings" on page 26.
- (4) Press [Color] for color copying, or [Black] for black & white copying.

Note

- The copied image may need to be enlarged to fit onto the selected page size when making borderless copies. Some cropping may occur.
- You can use this feature only when the page size is set to <8.5" x 11" (215.9 x 279.4)>, <A4>, <4" x 6" (101.6 x 152.4)>, <5" x 7" (127.0 x 177.8)>, or <Credit card>.
- You can use this feature only when the paper is set to <Photo Paper Pro>, <Photo Plus Glossy>, <Matte Photo Paper>, <Glossy Photo Paper>.
- You can specify Quality to either <Standard> or <High>.
- You can select the width to be cropped from the borders of the original image according to the image size.

● Repeating An Image On A Page (Image Repeat)

This feature enables you to copy an image multiple times onto a single page. You can set the machine to automatically select the number of times it repeats the image, or you can specify the number.

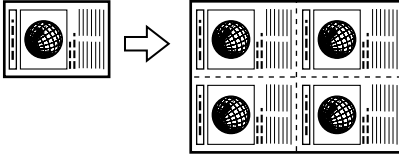

Procedure:

- (1) Display the Special copy screen.
See "Special Copy" on page 34.
- (2) Use [◀] or [▶] to select <Image repeat>, then press [OK].
- (3) Use [▲] or [▼] to select <Auto layout> or <Manual layout>.
If you selected <Auto layout> and pressed [OK], go to step (7).
If you selected <Manual layout> and pressed [OK], go to step (4).
- (4) Use [▲] or [▼] to set the vertical repeats.
- (5) Press [▶] to move the cursor to the right.
- (6) Use [▲] or [▼] to set the horizontal repeats, then press [OK].
- (7) Follow the on-screen instructions to load the document on the Platen Glass, then press [OK].
- (8) Specify the necessary items.
See "Changing The Print Settings" on page 26.
- (9) Press [Color] for color copying, or [Black] for black & white copying.

⚠ Important

- The area read from the documents depends on the enlargement/reduction ratio.
- The size of the documents to copy should be no larger than one division of the paper. For example, if you copy four documents at the same size, their sizes must be one-fourth of the page size or smaller.

📖 Note

- <Credit card> cannot be selected for the page size.
- <Fit-to-page> cannot be selected for <Magnification>.



Chapter 3 Printing From A Memory Card



Using A Memory Card

Let's take a look at different types of memory cards and how to insert and remove them.

■ Memory Cards Supported By This Machine

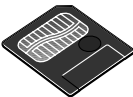
Supported memory cards are as follows:

Memory Cards which can be inserted directly	
	<ul style="list-style-type: none"> ● CompactFlash (CF) Card Supports TYPE I/TYPE II (3.3V) ● Microdrive
	<ul style="list-style-type: none"> ● Memory Stick ● Memory Stick PRO
	<ul style="list-style-type: none"> ● SD Secure Digital Memory Card ● MultiMedia Card (ver3.31)
	<ul style="list-style-type: none"> ● SmartMedia Card * Supports 3.3V card only 1MB and 2MB cards not supported

Memory Cards which can be used through a special adapter	
	<ul style="list-style-type: none"> ● xD-Picture Card *1
	<ul style="list-style-type: none"> ● Memory Stick Duo ● Memory Stick PRO Duo
	<ul style="list-style-type: none"> ● miniSD Card *2

*1 Purchase a CompactFlash Card Adapter for xD-Picture Card separately.

*2 Use the special adapter supplied with the card.

⚠ Important

- This machine accepts images taken with a camera compatible with the Design rule for Camera File system (Exif 2.21 compliant) and DPOF (Ver. 1.00 compliant).
- Photos stored in a memory card not supported by your digital camera may fail to load or be damaged. For types of memory cards supported by your digital camera, refer to the digital camera user's manual.
- Use the digital camera to format the memory card. Memory card data formats may not be compatible with computer-specific formats.
- Images edited on a computer may result in improper printing.
- Please use only one type of memory card at a time.

■ Inserting A Memory Card

📖 Note

- When <Read/write mode> is selected in the <Read/write attribute>, neither printing nor maintenance can be done. After using the card slot as the memory card drive for your computer, be sure to select <Read-only mode> again. See “Setting Up The Card Slot As The Memory Card Drive Of The Computer” on page 50.
- If you used a computer to edit or process the data stored in the memory card, be sure to print those photos from the computer. Using the Operation Panel to print such photos may result in improper printing.

1 Turn ON the machine.

2 Open the Card Slot Cover.

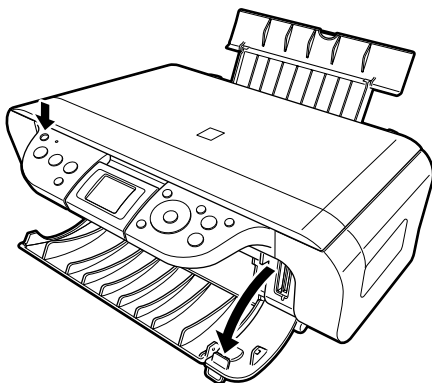

3 Install the memory card in the appropriate Card Slot.

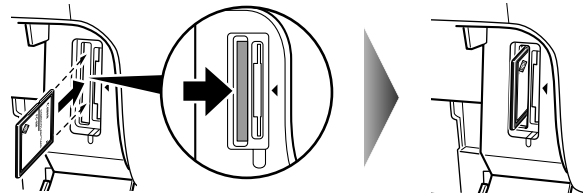
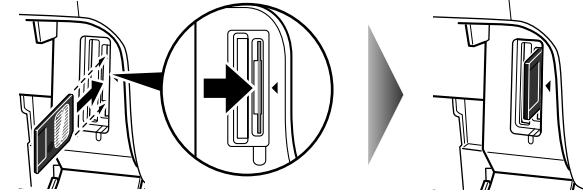
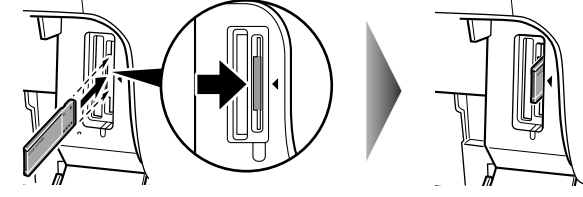
Type of card	How to install
<ul style="list-style-type: none">● CompactFlash (CF) Card● Microdrive● xD-Picture Card* Install these cards into the left card slot.	
<ul style="list-style-type: none">● SmartMedia Card Install this card into the right card slot.	
<ul style="list-style-type: none">● Memory Stick● Memory Stick PRO● Memory Stick Duo*● Memory Stick PRO Duo*● SD Card● miniSD Card*● MultiMedia Card (ver3.31) Install these cards into the right card slot.	

* Install the memory card with the appropriate adapter attached.

Note

Do not try to insert the memory card into the Card Slot furthermore than as it stops; otherwise the machine and/or the memory card will be damaged.

4 Check that the Access Lamp lights after blinking.

5 Close the Card Slot Cover.

■ Removing A Memory Card

Note

If you use the machine connected to your computer, follow the instructions for removal of the memory card from the computer.

1 Ensure that the Access Lamp is not flashing, then hold the exposed portion of the memory card with your fingers and remove the memory cards.

Important

Removing the memory card or turning OFF the machine while the Access Lamp is flashing can damage the data stored in the memory card.

2 Close the Card Slot Cover.

Printing Photograph

Let's select a photo from the photos stored on the memory card of the digital camera and print it.

■ Printing A Photo Displayed On The LCD - Single-photo Print

- 1 Turn ON the machine.
- 2 Load the paper in the Auto Sheet Feeder.
See "Loading Paper" on page 23.
- 3 Insert the memory card in the Card Slot.
See "Inserting A Memory Card" on page 38.
- 4 Select the print mode from the Menu.

- (1) Press [MEMORY CARD].
The Menu screen is displayed.

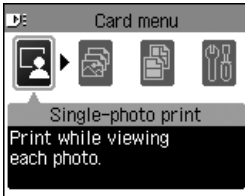

- (2) Use [◀] or [▶] to select <Single-photo print> and then press [OK].
The photo selection screen is displayed.

 **Note** The watch icon may appear when importing photos from a memory card.

- 5 Select the photo to print.

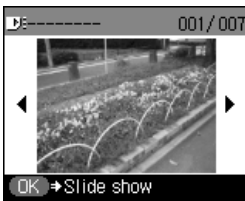

- (1) Use [◀] or [▶] to select the photo to print.
- (2) Press [Color].
The print confirmation screen is displayed.

 **Note** **Displaying Photos Automatically on the LCD (Slide Show)**

You can automatically display photos in sequence when selecting <Single-photo print>.

- To start the slide show, press [OK] when checking photos in <Single-photo print>.
- To stop the slide show, press [Stop/Reset] during the slide show.

6 Confirm the settings.

To change any of the settings, press [Settings].

See “Changing The Print Settings” on page 26.

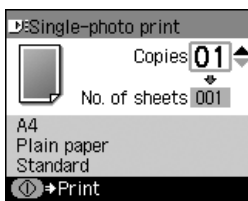

Press [▲] or [▼] to specify the number of copies to print.

7 Press [Color].

The printing starts.

■ Specifying How Many Copies To Print For Each Photo - Multi-photo Print

You can specify how many copies to print for each photo.

1 Prepare to print.

- (1) Turn ON the machine.
- (2) Load the paper in the Auto Sheet Feeder.
See “Loading Paper” on page 23.
- (3) Install the memory card into the Card Slot.
See “Inserting A Memory Card” on page 38.

2 Select the print mode from the Menu.

- (1) Press [MEMORY CARD].
The Menu screen is displayed.

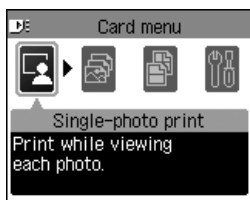

- (2) Use [◀] or [▶] to select <Multi-photo print> and then press [OK].
The photo selection screen is displayed.

3 Specify the number of copies to print.

(1) Use [◀] or [▶] to select the photo you wish to print.



(2) Use [▲] or [▼] to specify the number of copies to print.

(3) Repeat steps 1 and 2 and specify the number of copies for each photo you wish to print.

(4) Press [OK].

The print confirmation screen is displayed.

4 Confirm the settings.

To change any of the settings, press [Settings].

See "Changing The Print Settings" on page 26.

5 Press [Color].

The specified number of copies for each photo will be printed.

■ Printing By Using The Photo Index Sheet

With this machine, you can easily print photographs using a Photo Index Sheet, by filling in the appropriate circles to select print options and photographs you want to print. Simply scanning a Photo Index Sheet prints the selected photographs according to the selections you have made.

Follow this procedure:

1 Turn ON the machine, and load A4- or Letter-sized paper in the Auto Sheet Feeder.
Use completely white plain paper when printing a Photo Index Sheet.



Note

- For details on paper, see page 17.
- For details on how to load paper, see page 23.

2 Insert the memory card into the Card Slot. (See page 38)

3 Press [Photo Index Sheet].

The Photo Index Sheet menu is displayed.

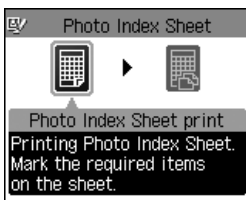

- 4 Use [◀] or [▶] to select <Photo Index Sheet print>, then press [OK].

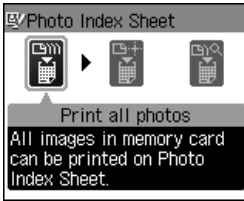

- 5 Use [◀] or [▶] to select the range of photographs to print on the Photo Index Sheet.

- <Print all photos>: Prints all image data stored on the memory card.
<Set no. of copies>: Prints image data stored on the memory card in chronological order beginning with the most recently recorded date.
<Search>: Prints image data stored on the memory card according to a specified range of recorded dates.

- If you select <Print all photos>:
 - (1) Go to step 6.
- If you select <Set no. of copies>:
 - (1) Press [OK].



- (2) Use [▲] or [▼] to select how many recent photographs to print, then press [OK].
 - (3) Go to step 6.
- If you select <Search>:
 - (1) Press [OK].



- (2) Use [◀] or [▶] to select the first recorded date of photographs you want to print, then press [OK].
- (3) Use [◀] or [▶] to select the last recorded date of photographs you want to print, then press [OK].
- (4) Go to step 6.

6 Press [Color].

The machine prints the Photo Index Sheets.

Note

If more than 37 photographs are to be printed, the machine prints them on more than one Photo Index Sheet.

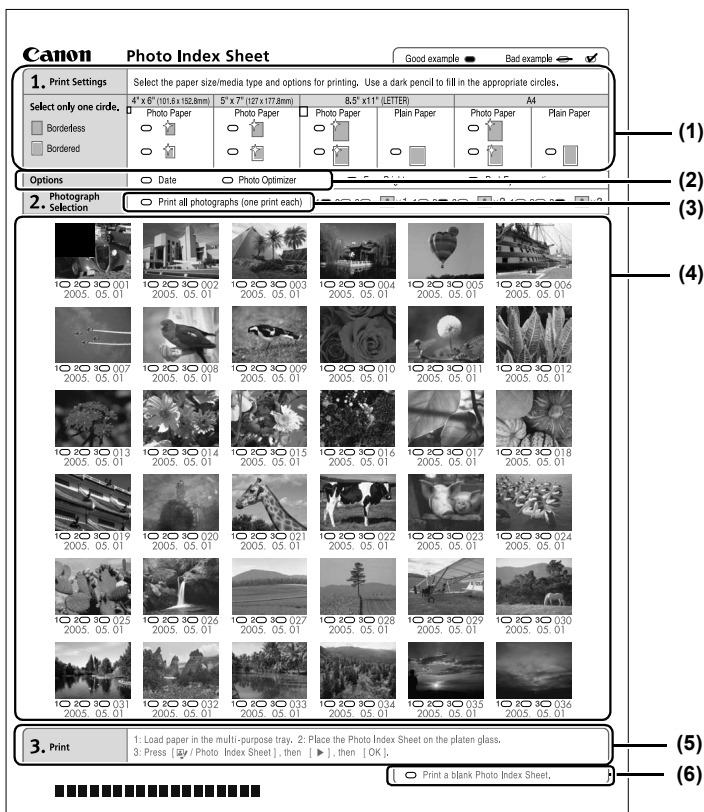





































Canon Photo Index Sheet Good example Bad example

1. Print Settings Select the paper size/media type and options for printing. Use a dark pencil to fill in the appropriate circles.

<input type="checkbox"/> 4" x 6" (102.6 x 152.4mm)	<input type="checkbox"/> 5" x 7" (127 x 177.8mm)	<input type="checkbox"/> 8.5" x 11" LETTER
<input type="checkbox"/> Photo Paper	<input type="checkbox"/> Photo Paper	<input type="checkbox"/> Plain Paper
<input type="checkbox"/> Photo Paper	<input type="checkbox"/> Photo Paper	<input type="checkbox"/> Plain Paper
<input type="checkbox"/> Borderless	<input type="checkbox"/> Bordered	<input type="checkbox"/> Plain Paper

Options Date Photo Optimizer

2. Photograph Selection Print all photographs (one print each)

 10 20 30 001 2005. 05. 01	 10 20 30 002 2005. 05. 01	 10 20 30 003 2005. 05. 01	 10 20 30 004 2005. 05. 01	 10 20 30 005 2005. 05. 01	 10 20 30 006 2005. 05. 01
 10 20 30 007 2005. 05. 01	 10 20 30 008 2005. 05. 01	 10 20 30 009 2005. 05. 01	 10 20 30 010 2005. 05. 01	 10 20 30 011 2005. 05. 01	 10 20 30 012 2005. 05. 01
 10 20 30 013 2005. 05. 01	 10 20 30 014 2005. 05. 01	 10 20 30 015 2005. 05. 01	 10 20 30 016 2005. 05. 01	 10 20 30 017 2005. 05. 01	 10 20 30 018 2005. 05. 01
 10 20 30 019 2005. 05. 01	 10 20 30 020 2005. 05. 01	 10 20 30 021 2005. 05. 01	 10 20 30 022 2005. 05. 01	 10 20 30 023 2005. 05. 01	 10 20 30 024 2005. 05. 01
 10 20 30 025 2005. 05. 01	 10 20 30 026 2005. 05. 01	 10 20 30 027 2005. 05. 01	 10 20 30 028 2005. 05. 01	 10 20 30 029 2005. 05. 01	 10 20 30 030 2005. 05. 01
 10 20 30 031 2005. 05. 01	 10 20 30 032 2005. 05. 01	 10 20 30 033 2005. 05. 01	 10 20 30 034 2005. 05. 01	 10 20 30 035 2005. 05. 01	 10 20 30 036 2005. 05. 01

3. Print 1: Load paper in the multi-purpose tray. 2: Place the Photo Index Sheet on the platen glass.
3: Press [Print] / Photo Index Sheet, then [OK].

Print a blank Photo Index Sheet.

(1) Select the page size and media type.

(2) Select date printing as necessary.

(3) Mark this to print one copy of each photograph.

*When you mark this, even if you mark the number of copies you want to print for each photograph, those marks will be disregarded, and one copy each of all photographs will be printed.

(4) Select the number of copies (fill in the respective circle under the photograph you want to print).

(5) Follow the procedure as described.

(6) Mark this to print the same Photo Index Sheet again.

*If you mark this, all other marked settings will be disregarded.

7 Fill in the appropriate circles () with a dark pencil to select the photographs to print and print settings.

● Good



● Bad



(1)



(2)



(3)

(1) Check mark

(2) Line only

(3) Light

! Important

- Be sure to fill in a circle for every setting item (except options).
- If there is more than one Photo Index Sheet, fill in all the sheets.
- If the filled circles on the Photo Index Sheet are not dark enough, the machine may not read the settings.

8 Load the paper selected on the Photo Index Sheet in the Auto Sheet Feeder.



Note

When printing image data using a Photo Index Sheet, you can select <8.5" x 11" (215.9 x 279.4)>, <A4>, <4" x 6" (101.6 x 152.4)>, or <5" x 7" (127.0 x 177.8)> for the page size.

9 Load the Photo Index Sheet on the Platen Glass.

When loading the Photo Index Sheet, place the front side down, and align the upper left corner of the sheet with the alignment mark on the lower right corner of the Platen Glass.

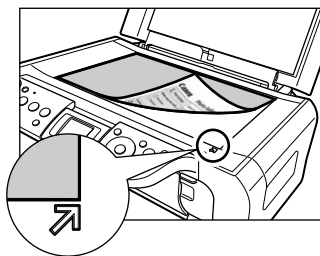

Caution

Be sure to load the Photo Index Sheet in the correct orientation on the Platen Glass.

10 Press [Photo Index Sheet].

11 Use [◀] or [▶] to select <Scan sheet and print>, then press [OK].

12 Press [OK].

The machine starts printing the specified photos.

 **Important**

- If the LCD displays <Failed to scan Photo Index Sheet>, press [OK] and ensure that a circle is filled in for each setting item.
- If the filled circles on the Photo Index Sheet are not dark enough, the machine may not read the settings.
- Do not remove the memory card while the machine is printing.
- If the Platen Glass is dirty, the machine may not read the settings.

 **Note**

- To cancel printing, press [Stop/Reset].
- To continue to print photographs using the subsequent Photo Index Sheets, repeat steps 7 to 12.

Other Useful Functions

The following functions are available when printing from a memory card:

- “Printing Several Photos On A Single Sheet Of Paper (Layout Print)” on page 46
- “Printing On Stickers - Sticker Print” on page 48
- “Other Printing Functions” on page 48

■ Printing Several Photos On A Single Sheet Of Paper (Layout Print)

You can print the specified photos in the specified layout.

1 Prepare for printing.

- (1) Turn ON the machine and load a sheet of sticker paper in the Auto Sheet Feeder.
See “Loading Paper” on page 23.

 **Note**

Load one sheet at a time in the Auto Sheet Feeder.

- (2) Insert the memory card into the Card Slot.
See “Inserting A Memory Card” on page 38.

2 Select the print menu.

- (1) Press [MEMORY CARD].
- (2) Use [◀] or [▶] to select <Special photo print>, then press [OK].
- (3) Use [◀] or [▶] to select <Layout print>, then press [OK].

3 Specify the layout.

- (1) Use [◀] or [▶] to specify the layout, then press [OK].
The following layouts can be selected.

<Bordered>: 2/4/8/Half/Half (w/lines)
<Borderless>: 2/4/8/Half/Half (w/lines)
<Album>: 4/right, 4/left
<Mixed>: 1/2/3



Note

- When you select <Borderless>, the media type cannot be set to <Plain Paper>.
- You can select Mixed 1-3 only when the page size is set to <8.5" x 11" (215.9 x 279.4)> or <A4>.

4 Specify the paste method.

- (1) Use [▲] or [▼] to select the pasting method.
If you select <Paste all> then press [OK], all photos saved on the memory card are automatically pasted in the specified layout. Go to step 6.
If you select <Paste one by one> then press [OK], the photo selection screen is displayed.

5 Paste photos one by one.

- (1) Use [◀] or [▶] to display the photo to be pasted, then press [OK].
(2) Repeat step 1 to paste photos.
Press [Back] to cancel the last pasted photo.
Press [Stop/Reset] to cancel all pasted photos.
(3) Press [Color] after pasting all photos.
The print confirmation screen is displayed.



Note

Pasting cannot be done over multiple pages. When you finish pasting photos for one page, print the page.

6 Start printing.

- (1) Press [Color].
The machine starts printing.

■ Printing On Stickers - Sticker Print

You can print your favorite photos on Canon Photo Stickers.

1 Prepare for printing.

See "Prepare for printing." on page 46

2 Select the print mode from the Menu.

(1) Press [MEMORY CARD].

(2) Use [◀] or [▶] to select <Special photo print> and then press [OK].

(3) Use [◀] or [▶] to select <Sticker print> and then press [OK].

3 Specify the layout.

(1) Use [◀] or [▶] to select <Stickers x16> and then press [OK].

You can only print in the Stickers x16 layout though other layouts appear on the LCD.

4 Select the photo to print.

(1) Use [◀] or [▶] to select the photo you wish to print and then press [OK].

(2) Use [◀] or [▶] to select the frame and then press [OK]

5 Start printing. (See page 47)



Note

You cannot configure the page size, media type, bordered or borderless printing, or dated or non-dated printing when using this function.

■ Other Printing Functions

The following print functions are also provided under the Special photo print menu.

● Print all photos

You can print all photos saved on the memory card.

● Photo Index print

You can print a list of all the photos saved on a memory card.



Note

The number of photos printed on a single sheet of paper depends on the size of the medium.

- A4 / Letter: 80 photos
- 5" x 7" / 127.0 x 177.8 mm: 35 photos
- 4" x 6" / 101.6 x 152.4 mm: 24 photos
- Credit Card: 6 photos

● DPOF print

If DPOF (Digital Print Order Format) settings are made on the camera, photos are printed automatically according to those settings.

Note

- This machine allows you to make the following DPOF settings:

Image format:

CIFF, JFIF, and Exif

Print type - Standard:

The photos for which you specified "Standard" using the DPOF function are printed.

Print type - Index:

The photos for which you specified "Index" using the DPOF function are printed according to the index print layout.

Photos to Print:

Only the photos specified using the DPOF function are printed (photos cannot be specified on the Operation Panel).

Copies:

Photos are printed according to the numbers of copies specified using the DPOF function (numbers of copies cannot be specified on the Operation Panel).

Other functions (addition of comments, trimming/rotation, etc.) are not supported.

- Photos are automatically scaled according to the page size. The upper, lower, left, and/or right portion(s) of the photo may be cropped depending on the size of the paper you use.
- The shooting date format is as specified in the DPOF setting under DPOF printing.

1 Prepare for printing. (See page 46)

2 Select the print menu.

(1) Press [MEMORY CARD].

(2) Use [◀] or [▶] to select <Special photo print> and then press [OK].

(3) Use [◀] or [▶] to select <DPOF print> and then press [OK].

3 Start printing. (See page 47)

Reading From And Writing To A Memory Card

Setting Up The Card Slot As The Memory Card Drive Of The Computer

Windows

Connecting the machine to a computer results in the memory card drive (removable hard disk) being displayed under [My Computer].

Macintosh

When a memory card is already inserted, connecting the machine to a computer results in the memory card drive (removable hard disk) being displayed on the desktop.

Inserting a memory card into the machine and then opening [Removable Disk] on your computer enables you to view the photos stored on the card. Furthermore, you can copy the files to your hard disk in the same way as any regular hard disk drive, and by changing the write protection setting, you can copy files from your hard disk onto a memory card.

▲ Important

- When the write protection is disabled on the machine, neither printing nor maintenance can be done. After using the card slot as the memory card drive for your computer, be sure to enable the write protection again. For details, see page 73.
- If you used the Card Slot as the memory card drive of the computer, you need to do a "safe removal" operation on your computer before physically removing the memory card from your machine.

Windows

Right-click the removable disk icon and click [Eject]. If [Eject] is not displayed on the screen, confirm that the Access Lamp is not flashing and remove the memory card.

Macintosh

Drag the  icon into the Trash.

■ Enabling Writing Of Data To Memory Cards

- 1 Make sure no memory card is inserted in the machine.
- 2 Press [Menu].
- 3 Use [◀] or [▶] to select <Maintenance/settings>, then press [OK].
- 4 Use [◀] or [▶] to select <Device settings>, then press [OK].
- 5 Use [▲] or [▼] to select <Other settings>, then press [OK].
- 6 Use [▲] or [▼] to select <Read/write attribute>, then press [OK].

7 Use [**▲**] or [**▼**] to select <Read-only mode> or <Read/write mode>, then press [OK].

Read-only mode: The Card Slot is used only for reading. Be sure to select this mode when printing photos from a memory card.

Read/write mode: The Card Slot is used as the memory card drive of the computer. Photo data can be written into the memory card.

 **Important**

- Windows 2000, when the write protection is enabled on the machine: If the computer does not detect that the write protection is enabled, a delayed write-error might occur and data could be corrupted when attempting to copy data to a memory card.
- You cannot write to memory cards when the machine is in Memory Card mode.

 **Note**

To change the write protection setting while a card is inserted in the Card Slot, unplug the USB cable before changing the setting, then plug it back in afterwards. The new setting is not applied unless you plug the USB cable back in.

Chapter 5

Printing From Your Computer

This chapter describes the basic printing procedure, taking the steps to print documents as an example.



Printing With Windows

Note

- Menu and command names may differ between software applications, and more steps may be required. For details, refer to the documentation for each software application you use.
- The steps described in this section are for printing in Windows XP Service Pack 2 (hereafter, called Windows XP SP2).

- 1 Press [ON/OFF] to turn ON the machine.
- 2 Load the paper in the Auto Sheet Feeder. (See page 23)
- 3 Create a document or open a file to print.
- 4 Open the printer properties dialog box.
 - (1) Select [Print] from the application software's [File] menu. The [Print] dialog box opens.
 - (2) Ensure that your machine is selected (1).

Note

If another name of machine is selected, click the name of machine to use.

- (3) Click [Preferences] or [Properties] (2). The [Main] tab of the [Preferences] screen is displayed.

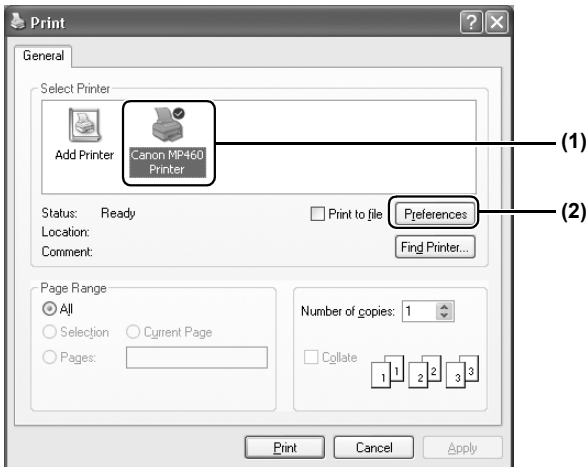

5 Specify the required settings.

- (1) Click [Media Type] to select the type of media loaded in the machine (1).
- (2) Specify the print quality and other settings in [Print Quality] or [Color/Intensity] (2).

 **Note** For print settings, see the *On-screen Manual*.

- (3) Click [OK] (3)
The [Printing Preferences] screen is closed.

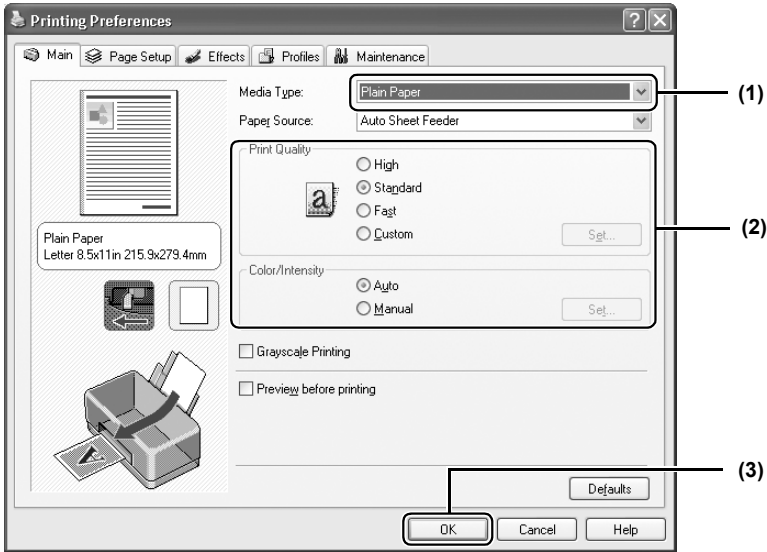

 **Note**

- From the [Page Setup] tab, select the correct document size to be printed.
- For details about other printer driver functions, click [Instructions] or [Help] to view the *Printer Driver Guide*. [Instructions] is only displayed when the *On-screen Manual* is installed.
- Selecting the [Preview before printing] check box displays a preview screen that allows you to confirm the selected printing effects and how your document will look when printed. Some applications do not have a preview function.

6 Print the document.

- (1) Click [Print] or [OK] (1).
The machine starts printing.

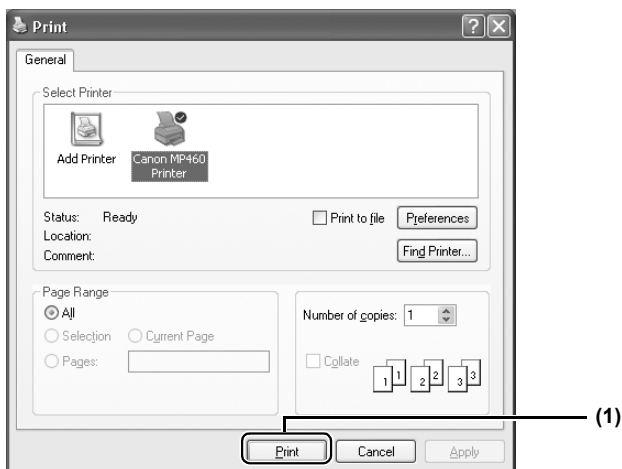

Note

- You can cancel a print job in progress by simply pressing [Stop/Reset] on the machine.
- Click [Cancel Printing] on [Canon IJ Status Monitor] to stop printing. To show [Canon IJ Status Monitor], click [Canon MP460 Printer] on the taskbar.
[Canon IJ Status Monitor] opens automatically when a machine error occurs.

Printing With Macintosh

Note

- Menu and command names may differ between software applications, and more steps may be required. For details, refer to the documentation for each software application you use.
- The steps described in this section are for printing in Mac OS X v.10.4.x.

- 1** Press [ON/OFF] to turn ON the machine. (See page 14)
- 2** Load the paper in the Auto Sheet Feeder. (See page 23)
- 3** Create a document or open a file to print.
- 4** Select [Paper Size].
 - (1) Select [Page Setup] from the application software's [File] menu. The [Page Setup] dialog box opens.
 - (2) Confirm that [MP460] is selected in [Format for] (1).
 - (3) Select the desired paper size from [Paper Size] (2).
 - (4) Click [OK] (3).

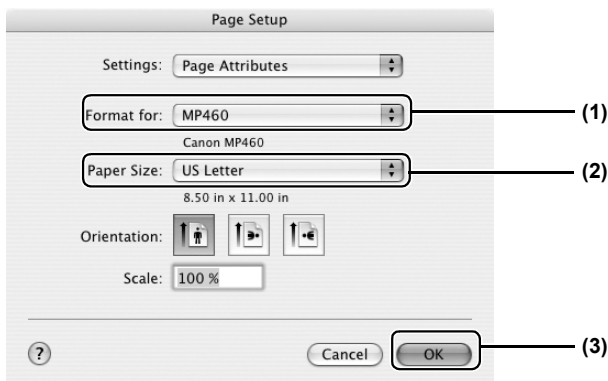

5 Specify the required settings.

- (1) Select [Print] from the application software's [File] menu.
The [Print] dialog box opens.
- (2) Select [Quality & Media] from the pop-up menu (1).
- (3) Select the desired media type from [Media Type] (2).
- (4) Select the print mode appropriate to your document from [Print Mode] (3).

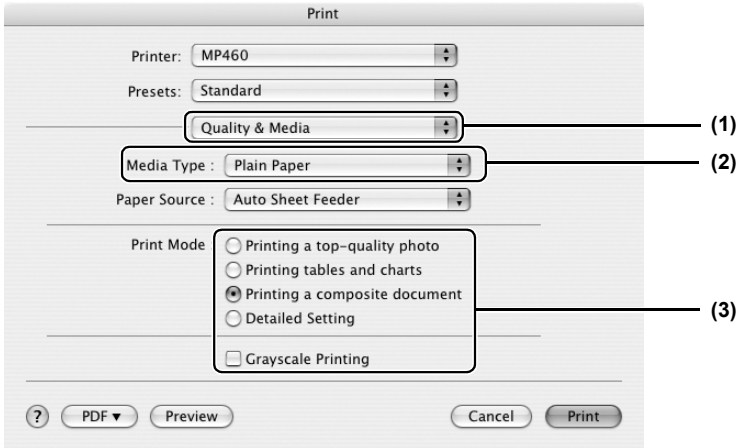

Note

- When you select the print mode appropriate to your document from [Print Mode], the document will be printed in color and at a print quality suited to the characteristics of the [Media Type] you have selected.
 - [Printing a top-quality photo]: Select when printing documents consisting mainly of photographs and graphics featuring fine color gradation.
 - [Printing tables and charts]: Select when printing documents consisting mainly of graphs and graphics (illustrations) with strong color definition.
 - [Printing a composite document]: Select when printing documents consisting mainly of text.
 - [Detailed Setting]: Select to fine-tune the [Print Quality] and [Halftoning] setting.
- For details about other printer driver functions, click [?] to view the *Printer Driver Guide*. If the *On-screen Manual* is not installed, the *Printer Driver Guide* is not displayed even if [?] is clicked.
- Clicking [Preview] displays a preview screen that allows you to confirm the selected printing effects and how your document will look when printed. Some applications do not have a preview function.

6 Print the document.

(1) Click [Print].

Note

- You can cancel a print job in progress by simply pressing [Stop/Reset] on the machine.
- Double-clicking the name of your machine in the [Printer List] of the [Printer Setup Utility] (When using Mac OS X 10.2.8, double-clicking the name of your machine in the [Printer List] of the [Print Center]) displays a dialog that prompts you to confirm the status of the print job. To cancel a job in progress, select the desired document, then click [Delete]. To temporarily stop a job in progress, click [Hold]. To stop all the jobs in the list, click [Stop Jobs] (when using Mac OS X v.10.3.x or Mac OS X v.10.2.8, click [Stop Printing]).

Chapter 6

Scanning Images

About Scanning Images

You can scan images from the machine into a computer, and save them in JPEG, TIFF, PDF, or Bitmap format. Then you can process that data by using the supplied application software to create original images. Furthermore, you can use the supplied OCR (Optical Character Recognition) software to convert scanned paper documents to text data.

■ Before Scanning

Before scanning images, confirm as follows:

- Does the document to be scanned meet the requirements for being set on the Platen Glass?
For details, see page 15.
- Is the machine connected to your computer correctly?

Make sure your machine and computer are correctly connected via the USB cable.

Scanning Methods

■ Scanning Using The MP Navigator

Using the MP Navigator, you can scan, process and save documents to your computer. For details on using the MP Navigator, see the *Scanning Guide*.

Windows

On the Windows desktop, double-click the [MP Navigator 3.0] icon to open the MP Navigator.

Macintosh

On the [Go] menu, select [Applications], [Canon Utilities], then double-click the [MP Navigator 3.0] icon to open the MP Navigator.

You can launch the following application software from the MP Navigator.

- Easy-PhotoPrint (Photo Printing)
- ArcSoft PhotoStudio (Photo image editing)
- ScanSoft OmniPage SE (Converting scanned document to text)

Note

- If you performed the [Custom Install] and only installed the MP Driver and MP Navigator, these application software were not installed and thus cannot be launched. To launch any of the above application software from MP Navigator, perform the [Custom Install] once again to install them.
- ScanSoft OmniPage SE does not support Windows 98 first edition.

■ Scanning With The Operation Panel Of The Machine

You can start the scan operation with the Operation Panel of the machine. (See the *Scanning Guide*)

● If you are using Windows XP

The program selection screen is displayed the first time you press [Color] or [Black] on the machine. Specify [MP Navigator Ver.3.0] as the application software to use, check [Always use this program for this action], then click [OK]. From the next time, MP Navigator is automatically started.

● When using Mac OS X

For the machine to start scanning when [Color] or [Black] is pressed, you need to set MP Navigator as the starting application software in Image Capture under [Applications] of Mac OS X.

! Important Make sure that the MP Navigator is installed and that the Macintosh is connected to the machine before starting up Image Capture.

If you are using Macintosh OS X v.10.3.x

Select [Applications] from the [Go] menu, then double-click [Image Capture]. Click [Options] at lower left of the scanner window, select [MP Navigator 3.0] from [Application to launch when scanner button is pressed], then click [OK].

! Important If you select [Preferences] from the [Image Capture] menu, click [Scanner], and mark [Use TWAIN software whenever possible], [Options] is not displayed. In this case, click [Use TWAIN software whenever possible] to uncheck the option, exit the Image Capture, then start it again.

If you are using Macintosh OS X v.10.2.8

Select [Applications] from the [Go] menu, then double-click [Image Capture]. Select [Preferences] from the [Image Capture] menu. Select [Others] from [When a scanner button is pressed, open], select [MP Navigator 3.0] from [Applications], then click [Open].

1 Load the document on the Platen Glass. (See page 15)

2 Press [SCAN].

- The scan operation selection screen is displayed.

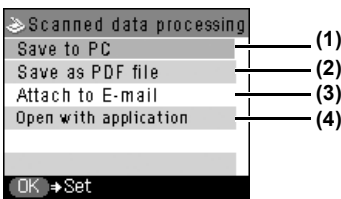



- (1) The document is scanned and saved.
- (2) The document is scanned and stored as a PDF file.
- (3) The document is scanned, and the image is attached to an e-mail using the e-mail application software.
- (4) The document is scanned and displayed on the registered application software.

3 Use [▲] or [▼] to select the scan operation, then press [OK].

4 Press [Color] or [Black].

The document is scanned. The settings configured from MP Navigator apply when scanning.

 **Important** If with some types of original the position and size of the image is not scanned in correctly, please refer to "Selecting the Behavior of the Operation Panel with MP Navigator" in the *Scanning Guide (On-screen Manual)* and change the MP Navigator [Document Type] and [Document Size] to match those of the original being scanned.

 **Note** The subsequent procedure varies depending on your settings. For details, see the *Scanning Guide*.

■ Scanning from an application software

You can scan an image from a TWAIN- or WIA- (Windows XP only) compliant application software and use the image in that application software. This procedure varies depending on the application software.

For the detailed procedure, refer to the manual of the application software you are using.

Printing Photographs Directly From A Digital Camera

Printing Photographs Directly From A PictBridge-Compliant Device

Connecting a PictBridge-compliant device such as digital camera, camcorder or mobile phone to the machine allows you to print recorded images directly without using a computer.

 **Note**

PictBridge is an industry standard enabling a range of digital photo solutions, including the direct printing of photos from compatible digital still cameras, camcorders or mobile phones without the need to use a computer.

*Hereafter, the digital still cameras, digital video camcorders and mobile phones are collectively called the PictBridge-compliant device.

■ Connecting To A PictBridge-Compliant Device

To connect a PictBridge-compliant device to this machine, use the USB cable supplied with the device.

 **Caution**

Do not connect any equipment other than PictBridge-compliant devices to the Direct Print Port of the machine. Doing so may result in an electric shock, fire, or damage to the device.

 **Note**

- When printing photos with the digital device connected to the machine, it is advisable to use the AC adapter supplied with the device. If you use the device's battery, be sure to it is fully charged.
- Depending on the model or brand of your device, you may have to select a mode for printing photos compliant with "PictBridge" before connecting the device.
- You may also have to turn ON the device or select Play mode manually after connecting the device to the machine. Perform such necessary operations according to the instruction manual supplied with your device.
- When printing from your PC, be sure to unplug the cable connecting the device.

- 1** Turn ON the machine.
Make sure the device is turned OFF.
- 2** Load the paper in the Auto Sheet Feeder.

3 Connect the PictBridge compliant device to the machine.

- (1) Connect the device to the machine using the USB cable (for connection to a computer) supplied with the device.
- (2) Turn ON and set up the device for direct printing.
When the connection between the device and machine has been established, the ON/OFF lamp on the machine flashes once.
* The power-on sequence may differ depending on the model or brand of the device.

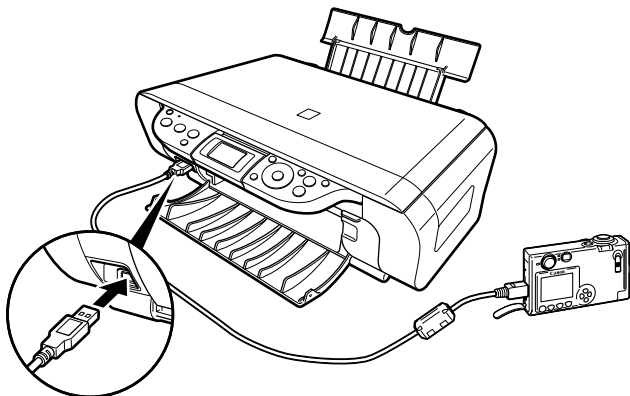

Following icon will be displayed on the LCD display of the device when the machine is correctly connected.



A PictBridge-compliant device.

* This mark indicates that the product is PictBridge-compatible.

■ Confirming Or Changing The Device Settings

To change the page size or media type, operate the device to select the PictBridge print setup mode and confirm or change the settings.

The settings below can be changed by pressing [Setting] in Memory card mode when the PictBridge-compliant device is connected.

However, changes can only be made on the properties screen when the corresponding items below are in the "Default Setting" (selections based on the machine setting) using the controls of the device.

- Page size
- Media type
- Layout
- Image optimize

About the Settings Explained Below

The settings explained on the following pages cannot be made on some devices. If any setting cannot be made, printing will be based on the specified "Default Setting".

The items for which the "Default Setting" is set will be printed based on the current machine setting.

Names of settings that are displayed on Canon PictBridge-compliant devices are used in the description given below.

Different names may be displayed on your device depending on the brand or model.

For details, refer to your device's instruction manual.

● About The Image Data Format For Printing

This machine accepts images* taken with a camera compatible with the Design rule for Camera File system and PNG files.

* Exif 2.21 compliant

● About "Page size" And "Media type"

When you have selected the "Default setting" (selections based on the machine setting), the machine operates based on the "Page size" and the "Media type" settings made using the controls of the machine.

The following sizes and types of paper can be loaded in the machine by selecting options in "Page size" and "Media type".

"Page size" setting	"Media type" setting	Paper loaded in machine
10 x 15 cm/4" x 6"	Photo	Photo Paper Plus Glossy
	Fast Photo	Photo Paper Pro
	Photo	Photo Paper Plus Semi-gloss
	Photo	Glossy Photo Paper
	Photo	Photo Stickers ^{*1}
13 x 18 cm/5" x 7" ^{*2}	Photo	Photo Paper Plus Glossy
Credit Card/5.4 x 8.6 cm	Photo	Glossy Photo Paper
A4/8.5" x 11" (Letter) ^{*3,*4}	Photo	Glossy Photo Paper
	Photo	Photo Paper Plus Glossy
	Photo	Photo Paper Plus Semi-gloss
	Fast Photo	Photo Paper Pro

^{*1} This paper is exclusively used to print photo stickers. When printing on sticker paper, select "10x15 cm/4" x 6"" in "Page size".

^{*2} This size can be selected only for Canon PictBridge compatible devices (note that it cannot be selected for some models).

^{*3} When "A4/8.5" x 11" (Letter)" is selected in "Page size", you can select "Plain Paper" in "Media type". When "Plain Paper" is selected in "Media type", bordered printing will be performed even if you select "Borderless" in "Layout".

^{*4} When "A4/8.5" x 11" (Letter)" is selected in "Page size", you can print in 4-up layout.

● About “Layout” and “Trimming”

For “Layout”, when the “Default setting” (selections based on the machine setting) is selected, the machine operates based on the bordered/borderless setting specified in the Memory card mode of the machine. Trimming is performed based on settings on the PictBridge-compliant device.

Note

- When printing onto Photo Stickers (PS-101) (16-up), use the following settings.
 1. Load Photo Stickers (PS-101) in the Auto Sheet Feeder.
 2. Select “10 x 15 cm / 4” x 6”” for the “Page size”, and “Photo” for the “Media type”.
 3. Select “N-up” for layout, then select “16”.
- Some PictBridge compliant devices display the Layout option; 2-up, 4-up, 9-up, and 16-up. In this case always select “16-up”. If there are no options on the PictBridge compliant device that correspond to 2-up, 4-up, 9-up, or 16-up, printing on stickers is not possible.
- When you are using Photo Stickers (PS-101), do not set “Borderless Printing” in “Layout” settings.

● About “Image Optimize”

When “Default setting” (selections based on the machine setting) is selected, the machine operates based on the settings in tab 2 of the Settings screen specified in Memory card mode of the machine. (See page 29)

If you use a Canon PictBridge-compliant device, you can select “VIVID”, “NR”, “VIVID+NR” or “FACE”.

(Note that these options cannot be selected on some models.)

Note

- When “VIVID” is selected, the green and blue portions of photos are printed more vividly.
- When “NR” (Noise Reduction) is selected, noise in blue portions, such as the sky, and dark portions is removed.
- When “VIVID+NR” is selected, functions of both “VIVID” and “NR” are performed.
- When “FACE” is selected, a darkened face on the photo taken against the light is brightened.

● About “Date/File No. print”

By default, “Off” is selected for this machine.

If you select an image which has had the shooting date embedded in it using a camera with the print mode, select “Off” for this function. If you select “Date”, “File No.”, or “Both”, the date and/or file number will be printed over the embedded date.

Note

- Never disconnect the USB cable during printing.
- When disconnecting the USB cable between the device and machine, follow the instructions given in the instruction manual of the device.
- Controls of the device cannot be used for the following:
 - Print quality setting
 - Printer maintenance
- For the device operation method and troubleshooting, refer to your digital device’s manual.

Printing Photos From A Wireless Communication Device

If you have a mobile phone with an infrared port for wireless data transmission, you can print photos through a cordless connection with the machine. You can also print photos received from Bluetooth-compatible mobile phones or PCs using the optional Bluetooth unit BU-20.

■ Setting The Page Size, Media Type, And Layout When Printing From A Mobile Phone

You can select the page size, media type, layout and borderless printing when printing from a mobile phone.

* The initial setting is borderless printing on 4" x 6" Photo Paper Plus Glossy.

- 1** Turn ON the machine.
- 2** Display the Wireless print settings screen.
 - (1) Press [Menu].
 - (2) Use [◀] or [▶] to select <Maintenance/settings>, then press [OK].
 - (3) Use [◀] or [▶] to select <Device settings>, then press [OK].
 - (4) Use [▲] or [▼] to select <Wireless print settings>, then press [OK].
The Wireless print settings screen appears.
- 3** Confirm or change the settings.
 - (1) Use [▲] or [▼] to select the item to set.
 - (2) Use [◀] or [▶] to change the setting.
 - (3) Press [OK] after finishing all settings you need.

■ Setting Items

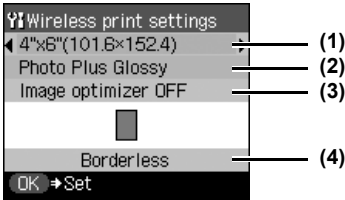

- (1) Select the page size for printing.
- (2) Select the media type for printing.
- (3) Corrects the contours and smoothes out the jaggedness that occurs when a small-sized photo is printed on large-sized paper.
- (4) Select the layout of the photo from:

Sticker print:

Stickers x16

Printing on paper other than sticker:

Bordered: x1, x2, x4, x8

Borderless: x1, x2, x4, x8

Mixed: 1, 2, 3

Note

Mixed 1, Mixed 2, and Mixed 3 can be selected only when the page size setting is <8.5" x 11" (215.9 x 279.4)> or <A4>.

Performing Infrared Communication

You can print photos in your mobile phone through infrared communication.

When performing infrared communication, also refer to your mobile phone manual.

1 Prepare to print.

- (1) Turn ON the machine and load the paper in the Auto Sheet Feeder.
See "Loading Paper" on page 23.

2 Specify the necessary print settings. (See page 65)

3 Start Infrared Communication.

- (1) Oppose the infrared port of the mobile phone to that of the machine at a distance of less than 20 cm (7.87 in.).

Note

- The effective angle of the infrared port of the machine is about 10° from the central axis in both vertical and horizontal directions.
- The allowable distance of communication with the machine depends on the mobile phone you use. For this distance, refer to your mobile phone manual.

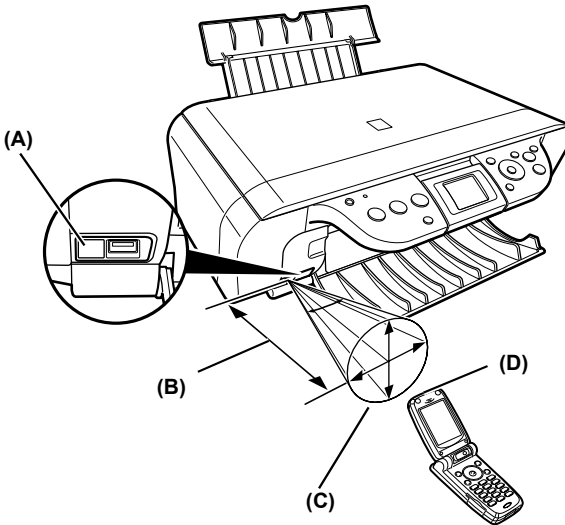

(A) Infrared port of machine

(B) Less than 20 cm (7.87 in.) (Do not block with any obstacle.)

(C) Effective angle (in both vertical and horizontal direction): About 10°

(D) Infrared port of mobile phone

- (2) Select the photo to print and send the data to the machine using the infrared communication function of the mobile phone.
The ON/OFF lamp on the machine flashes in green when received the data properly.
Printing will start after receiving all data.

 **Note**

- For the procedure to print from your mobile phone, refer to your mobile phone manual.
- Do not place any obstacle between the infrared ports of the machine and mobile phone. Data cannot be transmitted between them.
- During printing, be careful not to interrupt infrared communication with the machine. If it is interrupted, turn OFF the machine and cancel printing on the mobile phone.
- Following limitations apply on transmittable data.
 - It does not support printing a downloaded content or photo and a photo attached to an email for security reason.
 - It does not support printing video files.
- Depending on your device, the Fine print quality option may not be available due to the restriction on the infrared transfer capacity.
- Depending on your device, it may not print data stored in a memory card.
- Depending on the size of a photo, it may take a while for this machine to start to print after starting the infrared transfer.
- It automatically sets the photo quality and orientation (horizontal or landscape) according to the photo size.
- It automatically sets to the margin according to the photo size.
- We recommend printing on sticker or credit card sized paper when the print quality on other types of paper is not fine.

Performing Bluetooth Communication

The following describes how to print photo communicating Bluetooth mobile phones using the optional Bluetooth unit BU-20. For performing Bluetooth communication, refer to the *Bluetooth User's Guide*. See also the manuals supplied with your Bluetooth compatible device.

- 1 Prepare to print.
 - (1) Turn ON the machine and load the paper in the Auto Sheet Feeder.
See "Loading Paper" on page 23.
- 2 Specify the necessary print settings.
See "Changing The Print Settings" on page 26.
- 3 Install the Bluetooth unit BU-20 to the Direct Print Port.

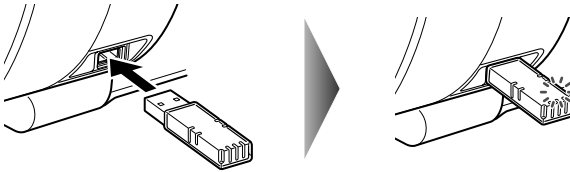

 **Note**

- The blue lamp on the Bluetooth unit BU-20 lights if it is properly installed.
- The Bluetooth settings screen does not appear until the Bluetooth unit is installed.

- 4 Display the Bluetooth settings screen.
 - (1) Press [Menu].
 - (2) Use [◀] or [▶] to select <Maintenance/settings>, then press [OK].
 - (3) Use [◀] or [▶] to select <Device settings>, then press [OK].
 - (4) Use [▲] or [▼] to select <Bluetooth settings>, then press [OK].
The Bluetooth settings screen is displayed.
- 5 Confirm or change the settings.
 - (1) Use [▲] or [▼] to select the item to set.
 - (2) Use [▲], [▼], [◀], [▶] to select the settings.
 - (3) Press [OK] after finishing all settings you need.

■ Setting Items

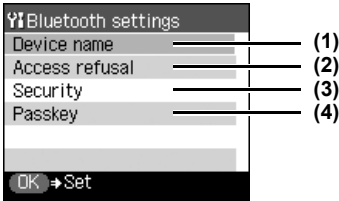

- (1) Select the device name of this machine displayed on the screen of the mobile phone.
- (2) Selecting ON will enable a passkey to be set or changed. Setting a passkey will help prevent interference from other Bluetooth devices.
- (3) Selecting ON will disable search and printing from Bluetooth devices.
- (4) You can change the passkey. The passkey refers to an identification number to be determined. It is used to prevent interference from other Bluetooth devices.



Note

For details and the procedure to print through Bluetooth communication, refer to the *Bluetooth User's Guide*.

Changing The Machine Settings

Changing The Machine Settings

This section describes the procedure for changing the settings in the Device settings screen, using the steps to specify Extended copy amount as an example.

- 1 Press [ON/OFF] to turn ON the machine.
- 2 Display the Device settings screen.
 - (1) Press [Menu].
The Menu screen is displayed.
 - (2) Use [◀] or [▶] to select <Maintenance/settings>, then press [OK].
The Maintenance/settings screen is displayed.

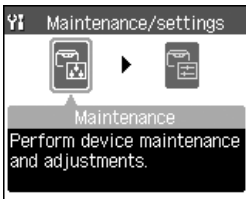

- (3) Use [◀] or [▶] to select <Device settings>, then press [OK].
The Device settings screen is displayed.

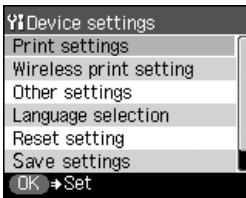

- 3 Select the menu.
 - (1) Use [▲] or [▼] to select <Print settings>, then press [OK].
 - (2) Use [▲] or [▼] to select the menu, then press [OK].
Example: select <Extended copy amount>.

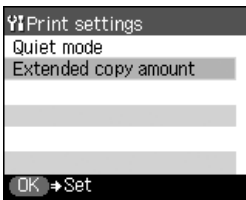

4 Change the settings.

- (1) Use [▲] or [▼] to select the setting item, then press [OK].
Example: select <Small>.

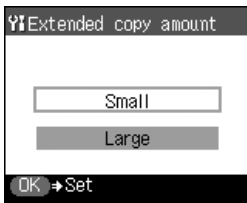

Note

Depending on the functions you use, some setting items cannot be specified in combination.

Print Settings

■ Quiet mode

Use this function if you want to reduce any operating noise, such as when printing at night.

Important

- The printing speed may be reduced compared to when this setting is set to <OFF>.
- This function may not be so effective depending on the print quality setting.
- Furthermore, certain noise, such as when the machine is preparing for printing, is not reduced.

■ Extended copy amount

Selects the amount of image that extends off the paper when printing in Borderless (full) mode.

Wireless Print Settings

For details, see "Setting The Page Size, Media Type, And Layout When Printing From A Mobile Phone" on page 65.

■ Page size

Specifies the page size for printing photos saved on a mobile phone.

■ Media type

Specifies the media type for printing photos saved on a mobile phone.

■ Image optimizer

When <Image optimizer ON> is selected, corrects the jagged outline of a person's image and makes it smooth for printing.

■ Layout print

Specifies the layout for the paper when printing photos saved on a mobile phone.

Note

<Mixed 1>, <Mixed 2>, or <Mixed 3> can be selected only when the page size is set to <8.5" x 11" (215.9 x 279.4)> or <A4>.

Bluetooth Settings

For details, see “Performing Bluetooth Communication” on page 69.

■ Device name

Specifies the name of this machine that is displayed on a Bluetooth compatible device.

■ Access refusal

When this is set to <ON>, the machine denies access from a Bluetooth compatible device.

■ Security

When this is set to <Enable>, the passkey can be specified.

■ Passkey

Changes the passkey.

Other Settings

■ Date display

Changes the display order for shooting dates to be printed.



Note

- When <Print date only> or <Print date & file no.> is selected in the <Settings 1> tab on the Settings screen (Memory card), the shooting date is printed in the date display order you selected. For Print settings, see “Changing The Print Settings” on page 26.
- The shooting date format is as specified in the DPOF setting from DPOF printing.

■ Read/write attribute

Selects whether to allow data to be written onto memory cards from a computer.



Important

If you set this setting to <Read/write mode>, the operation for printing or maintenance cannot be performed. After you finish operation of the memory card dedicated drive, be sure to revert this setting to <Read-only mode>.

■ Adjust contrast

Use this to adjust the contrast of the LCD if it is too low or too high.

■ Slide show setting

Displays the photos clearly during the slide show.



Note

When <Image quality: Std> is selected, images are displayed at 5-second intervals. When <Image quality: High> is selected, images are displayed at different time intervals according to their resolutions.

Language Selection

Changes the language for LCD messages.

Reset Setting

You can change the settings back to the default, except for the language for LCD messages and the position of the print head.

Save Settings

Saves the current settings for the Settings screen.

Load Settings

Loads the saved settings for the Settings screen.

Chapter 10

Routine Maintenance

Replacing A FINE Cartridge

If there is no improvement with the quality of printing following such maintenance as FINE Cartridge Cleaning, one of the FINE Cartridges is probably empty. Replace the empty FINE Cartridge with a new one. When replacing a FINE Cartridge, check the model number very carefully.

The machine will not print properly if the wrong FINE Cartridge is used, or installed incorrectly.

Black: PG-40 Black



PG-40

Color: CL-41 Color



CL-41

The FINE Cartridge PG-50 Black (High Yield) and CL-51 Color (High Yield) are also compatible with this machine.

■ Replacing A FINE Cartridge

When a FINE Cartridge runs out of ink, replace it using the following steps.

- 1 Ensure that the machine is turned ON, and then open the Scanning Unit.
The FINE Cartridge Holder moves to the left.

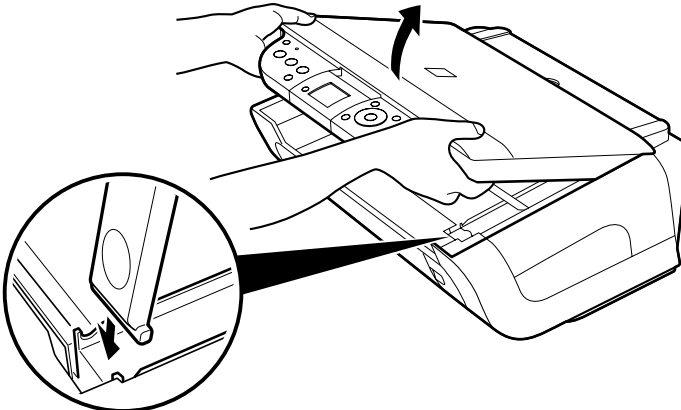

Pull the Scanning Unit Support down into place.

2 Remove the empty FINE Cartridge.

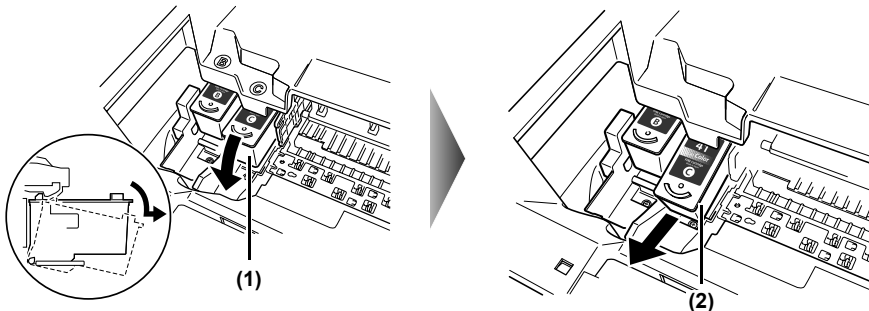

(1) Push the FINE Cartridge down.

(2) Remove the FINE Cartridge.

⚠ Important

- Handle FINE Cartridges carefully to avoid staining your clothes or the surrounding work area.
- Discard empty FINE Cartridges according to local laws and disposal regulations.

⚠ Caution

Do not touch the transparent film (A), film cable (B), ink absorber (sponge part) (C), or any metal parts.

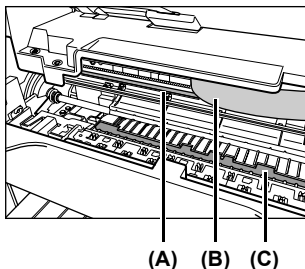

3 Prepare a replacement FINE Cartridge.

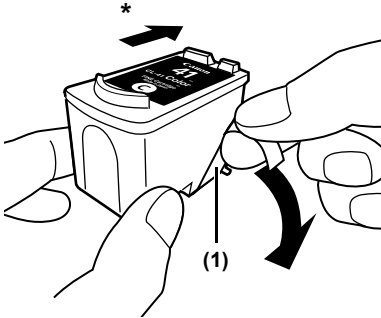

* To the Cartridge Holder.

(1) Unpack a new FINE Cartridge and remove the Protective Tape.

⚠ Important

- Do not reattach the Protective Tape once you have removed it.
- Handle the removed Protective Tape carefully to avoid getting your hands dirty or staining the surrounding work area once you have removed it.
- Once the Protective Tape is removed, do not touch the gold terminals of the FINE Cartridge or its nozzles. The machine may not print out properly if you touch the terminals.

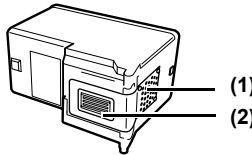

(1) Gold terminal

(2) Nozzle

4 Insert the new FINE Cartridge.

Black FINE Cartridges should be installed into the left holder (B) and Color FINE Cartridges should go into the right holder (C).

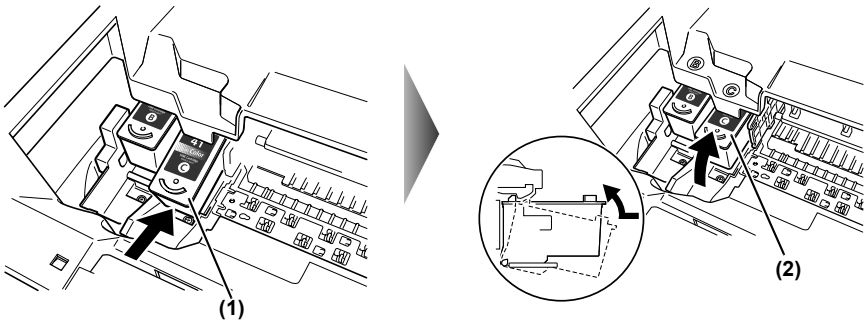

(1) Insert a new FINE Cartridge on a slight tilt.

(2) Push the FINE Cartridge up until it clicks into place.

5 Close the Scanning Unit.

Lift the Scanning Unit slightly to put the Scanning Unit Support back to its original position. The FINE Cartridge Holder moves to the right.



Note

If the straight line is misaligned or the FINE Cartridge position is misaligned, align the FINE Cartridge position. See "Aligning The FINE Cartridge" on page 91.



Important

- To maintain optimal print quality, we recommend that you use Canon brand FINE Cartridge. Replenishing ink only is also not recommended.
- Replace the FINE Cartridge promptly. Do not leave with the FINE Cartridge removed.
- When a FINE Cartridge runs out of ink, replace the FINE Cartridge with a new one immediately. If you replace it with the FINE Cartridge that has previously been removed, the machine may not print properly due to clogged FINE Cartridge nozzles. Furthermore, the Low Ink Warning dialog box which advises when to exchange the FINE Cartridge will be inaccurate.
- To maintain optimal print quality, use up all the ink in the FINE Cartridge within six months of its first use (We recommend that you note the date that the FINE Cartridge was installed in the machine).
- Color ink consumption may occur even when black-and-white or grayscale printing is specified.
Color ink is consumed during Cartridge cleaning, which is necessary to maintain the machine's capabilities.

■ Knowing When To Replace A FINE Cartridge

It is important to identify the empty Cartridge using the LCD and replace it.



Note

Should missing characters or white streaks appear despite sufficient ink levels, see "When Printing Becomes Faint Or Color Is Incorrect" on page 84.

● When Ink is Low

An exclamation above one or both FINE Cartridges shows that the remaining ink level is low.

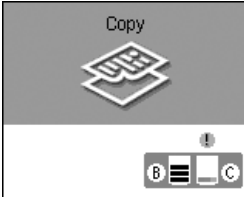

● When Ink is Empty

The following message appears on the LCD when ink becomes empty during printing.

Printing will resume as soon as the FINE Cartridge is replaced and the Scanning Unit is closed.

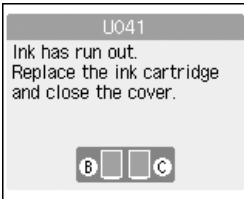

- Press [Stop/Reset] to cancel the current print job.
- Press [OK] to resume printing with an empty FINE Cartridge.

When printing is finished, replace the FINE Cartridge immediately. If you continue printing with an empty FINE Cartridge, it will be a cause of trouble.

* Be sure to press [OK] with all the FINE Cartridges installed. Printing does not resume if any of the FINE Cartridges are left uninstalled.

* If you continue to print with an empty FINE Cartridge, the ink level on the LCD will not be displayed correctly.

● Checking the Ink Level

You can check the current ink level by pressing [COPY], [SCAN] or [MEMORY CARD]. The LCD will display the ink level for a few seconds. The amount of remaining ink is displayed at 4 levels on the machine's LCD.

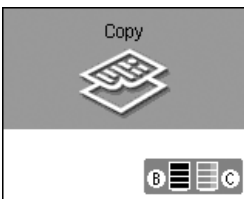

 **Note**

If an error message is displayed on the LCD, a FINE Cartridge error has occurred and the machine cannot continue to print. See “An Error Message Is Displayed On The LCD” on page 98.

■ What Is A Low Ink Warning?

The Low Ink Warning is the ink counter calculating the a remaining level of ink and advising you that the FINE Cartridges are running out of ink during printing.

The ink counter assumes the ink is full when a new FINE Cartridge is installed, and then starts the remaining level of ink. In this instance, if an old FINE Cartridge is installed, a message that the remaining level of ink cannot be detected appears.

Note

How to Check the Ink Level

Windows

Open the [Printer Properties] dialog box. Click the [Maintenance] tab and then click [View Printer Status].

[Canon IJ Status Monitor] appears. It also appears automatically during printing.

Macintosh

Open the [Canon IJ Printer Utility] dialog box, and then select [Ink Level Information] from the pop-up menu.

- When the “!” mark appears on the Low Ink Warning

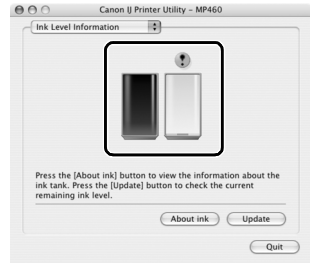
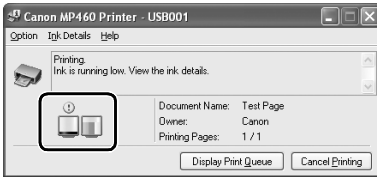

The ink level of the FINE Cartridge showing the “!” mark is low. You should ensure you have a new FINE Cartridge.

Note

Setting of FINE Cartridges

If a FINE Cartridge runs out of ink, you can print with either the Color or Black FINE Cartridge only for a while. However the same printing quality cannot be expected, compared to printing with both cartridges.

Windows

1. Open the [Printer Properties] dialog box.
2. Click the [Maintenance] tab and then [Ink Cartridge Settings].
3. Select [Color only] when the cartridge runs out of Black ink, or select [Black only] when the cartridge runs out of Color ink, and then click the [OK] button.

Macintosh

1. Open [Printer Setup Utility] (or [Print Center]).
2. Double-click the model name from [Name] in the Printer List, and then click [Utility].
3. Choose the name of your machine from [Product] and click the [Maintenance] button.
4. Choose [Ink Cartridge Settings] from the pull down menu.
5. Select [Color only] when the cartridge runs out of Black ink, or select [Black only] when the cartridge runs out of Color ink, and then click the [Apply] button.

The Black only setting can be used when you select [Plain Paper] in the [Media Type]. In this case the Borderless Printing setting cannot be enabled.

If you select [Color only] or [Black only] when the cartridge runs out of ink, remember to return the [Ink Cartridge Settings] to [Both Black and Color] after replacing with new one.

- When the “?” mark appears on the Low Ink Warning

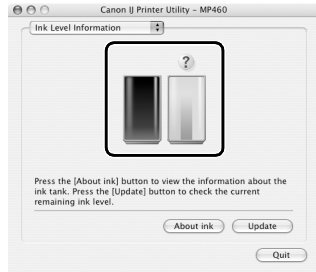

If you install an old FINE Cartridge, the “?” icon appears for the FINE Cartridge in question. In this case, the remaining level of ink cannot be calculated correctly. We recommend that you replace the FINE Cartridge with a new one.

If you try printing when “?” mark appears, the following message appears and printing stops.



In either case, clicking [OK] cancels the error indication and enables continuation of printing. However, the error detection function is disabled after the error indication is canceled, therefore, Low Ink Warning message does not appear later on. When you install a new FINE Cartridge, the Low Ink Warning is enabled automatically.

When Printing Becomes Faint Or Color Is Incorrect

If the printing becomes faint or the colors are incorrect, the FINE Cartridge Nozzles are probably clogged. Follow the procedures below to clean these nozzles.

Note

Before Performing Maintenance

Remove the FINE Cartridge once, then reinsert it into place.

See “Replacing A FINE Cartridge” on page 75.

Adjusting the printer driver for the [Print Quality] setting to [High] for Windows, or [Fine] for a Macintosh, may improve the print quality.

See “Increase the [Print Quality] setting” in the *Printer Driver Guide*.

Step 1

See “Printing The Nozzle Check Pattern” on page 85

If missing lines or white stripes appear



Step 2

See “FINE Cartridge Cleaning” on page 89

If the problem persists after performing
FINE Cartridge Cleaning twice



Step 3

See “FINE Cartridge Deep Cleaning” on page 90

If the problem still persists after performing
FINE Cartridge Deep Cleaning twice



Step 4

See “Replacing A FINE Cartridge” on page 75



After FINE Cartridge
Cleaning,
print the nozzle
check pattern.

Note

If ruled lines appear misaligned when printed, adjust the FINE Cartridge position.
See “Aligning The FINE Cartridge” on page 91.

Printing The Nozzle Check Pattern

Print the nozzle check pattern to determine whether the ink is being ejected properly from the FINE Cartridge Nozzles. Use this function when the printed results are blurred or the color is incorrect.

■ Performing Maintenance

- 1 Press [ON/OFF] to turn ON the machine.
- 2 Press [Menu].

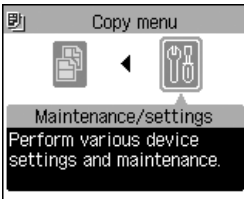

- 3 Display the Maintenance screen.

- (1) Use [◀] or [▶] to select <Maintenance/settings>, then press [OK].
The Maintenance/settings screen is displayed.

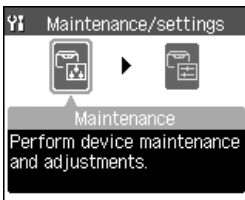

- (2) Use [◀] or [▶] to select <Maintenance>, then press [OK].
The Maintenance screen is displayed.

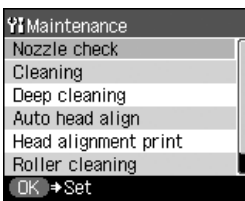

- (3) Use [▲] or [▼] to select the setting item, then press [OK].
The setting screen for the selected item is displayed.

■ Printing The Nozzle Check Pattern

- 1 With the machine ON, load a sheet of A4- or Letter-sized plain paper in the Auto Sheet Feeder.
- 2 Print the Nozzle Check Pattern.
 - (1) Display the Maintenance screen.
 - (2) Use [▲] or [▼] to select <Nozzle check>, then press [OK]. The pattern print confirmation screen is displayed.

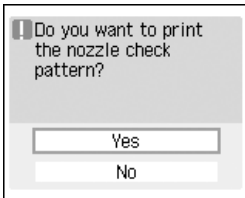

- (3) Use [▲] or [▼] to select <Yes>, then press [OK]. The nozzle check pattern is printed.

- 3 Confirm the nozzle check pattern.
See “Examining The Nozzle Check Pattern” on page 87.

■ Examining The Nozzle Check Pattern

The nozzle check pattern should appear as follows when ink is discharged properly. Examine the nozzle check pattern output by the machine.

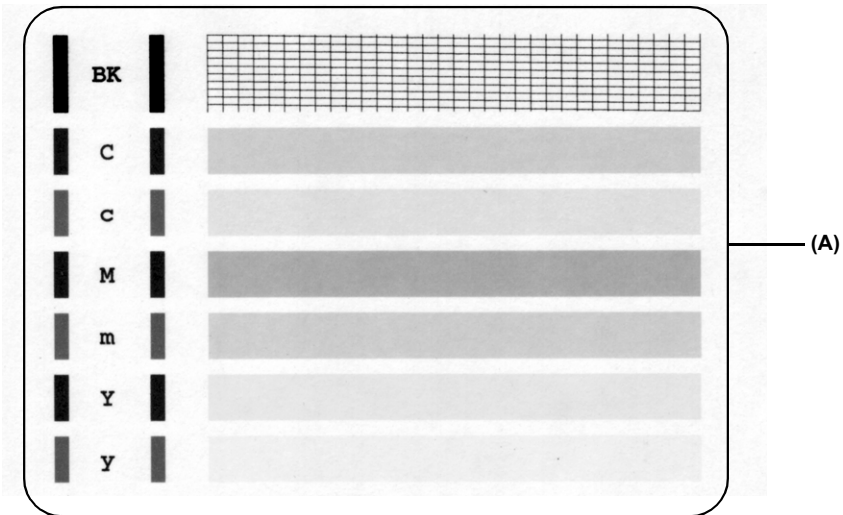

- If the lines are broken (1), or white lines (2) are present in the pattern (A), replace the relevant ink tank. (See “Replacing A FINE Cartridge” on page 75.)

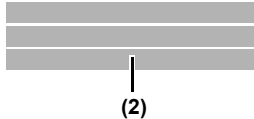
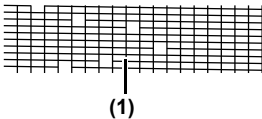

- **There are no white stripes./All patterns are printed normally.**

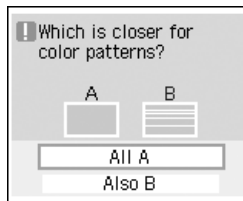
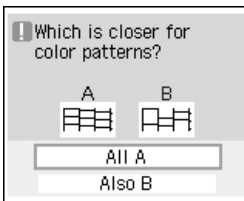

- (1) Select <All A> and press [OK].
The screen returns to the Maintenance screen.

● **A white stripe exists on any of the printed patterns.**

- (1) Select <Also B> and press [OK].
The cleaning confirmation screen is displayed.

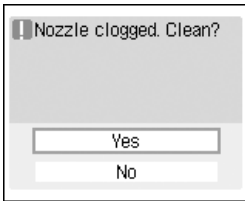

- (2) Select <Yes> and press [OK] to start FINE Cartridge Cleaning.

FINE Cartridge Cleaning

If missing lines or white stripes are found in the printed nozzle check pattern, proceed with a FINE Cartridge Cleaning to unclog the FINE Cartridge Nozzles. Cleaning the FINE Cartridge Nozzles consume inks, so perform FINE Cartridge Cleaning only when necessary.

- 1 Ensure that the machine is turned ON and the Scanning Unit is closed.
- 2 Start FINE Cartridge Cleaning.

- (1) Display the Maintenance screen.

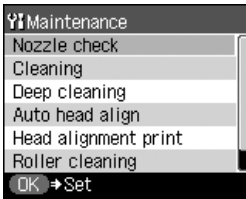

- (2) Use [▲] or [▼] to select <Cleaning>, then press [OK].
- (3) When the confirmation message is displayed, select <Yes> and press [OK]. FINE Cartridge Cleaning starts when the ON/OFF lamp starts flashing.

! Important Do not perform any other operations until the FINE Cartridge Cleaning finishes. This takes about 70-155 seconds.

- 3 Check the FINE Cartridge condition.

- (1) When the Nozzle check confirmation screen is displayed, print the nozzle check pattern. A nozzle check pattern will be printed.
Do not perform any other operation until the printing of the nozzle check pattern is finished.
- (2) Look carefully at the printout of the nozzle check pattern to evaluate the condition of the FINE Cartridge.
See "Examining The Nozzle Check Pattern" on page 87.
- (3) If the problem persists even after you have performed the normal FINE Cartridge Cleaning procedure two times, execute FINE Cartridge Deep Cleaning.
See "FINE Cartridge Deep Cleaning" on page 90.

FINE Cartridge Deep Cleaning

If the print quality does not improve after a standard FINE Cartridge Cleaning, try FINE Cartridge Deep Cleaning, which is a more powerful cleaning process. FINE Cartridge Deep Cleaning consumes more ink than standard FINE Cartridge Cleaning, so perform this procedure only when necessary.

- 1 Ensure that the machine is turned ON and the Scanning Unit is closed.
- 2 Start FINE Cartridge Deep Cleaning.

- (1) Display the Maintenance screen.

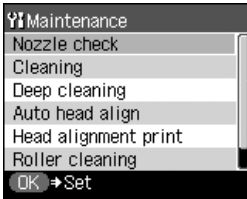

- (2) Use [▲] or [▼] to select <Deep cleaning>, then press [OK].
- (3) When the confirmation message is displayed, select <Yes> and press [OK]. FINE Cartridge Deep Cleaning starts when the ON/OFF lamp starts flashing.

⚠ Important Do not perform any other operations until FINE Cartridge Deep Cleaning finishes. This takes about one to three minutes.

- 3 Check the FINE Cartridge condition.

- (1) Print a nozzle check pattern to evaluate a FINE Cartridge condition.
See "Printing The Nozzle Check Pattern" on page 85.
- (2) If the problem persists, turn OFF the machine for at least 24 hours, and perform step 2 again.
- (3) If the problem persists, the machine may have run out of ink.
See "Replacing A FINE Cartridge" on page 75.

📖 Note If FINE Cartridge Deep Cleaning does not improve the print quality even if you have replaced the Cartridge, contact a Canon service representative.

Aligning The FINE Cartridge

If ruled lines are misaligned or a printout is unsatisfactory, FINE Cartridge Alignment is required.

- 1 With the machine ON, load a sheet of A4- or Letter-sized plain paper in the Auto Sheet Feeder.

Move the Paper Thickness Lever to the left position.

- 2 Print the pattern.

- (1) Display the Maintenance screen.

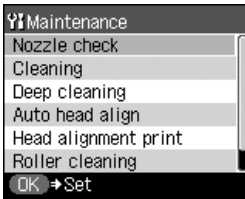

- (2) Use [**▲**] or [**▼**] to select <Auto head align>, then press [OK].
- (3) When the confirmation message is displayed, select <Yes> and press [OK].
The head alignment sheet will be printed.

3 Align the FINE Cartridge.

- (1) Beginning from column A on the printout, fill in the appropriate circles () with a dark pencil to select the most solid image

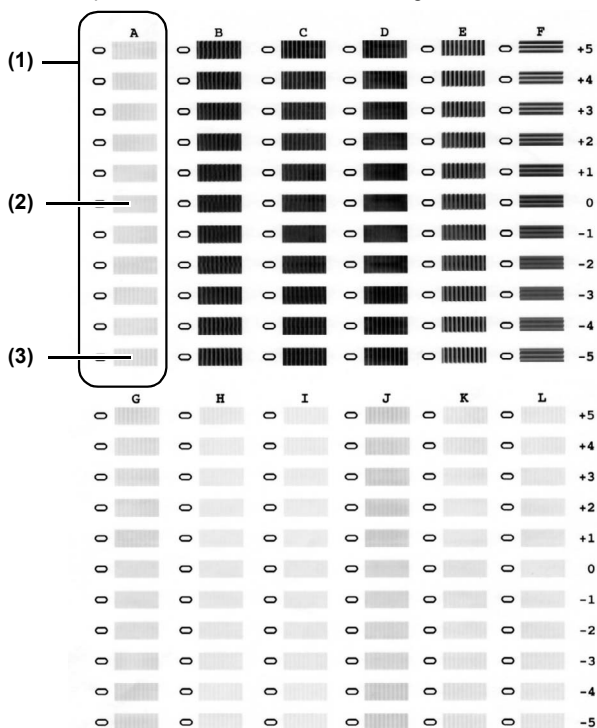

- (1) Column A
 (2) Good example (Most solid box)
 (3) Bad example (Least solid box)
- (2) Load the checked sheet on the Platen Glass.
 When loading the checked sheet, place the front side down, and align the upper left corner of the sheet with the alignment mark on the lower right corner of the Platen Glass.
- (3) Press [OK].
 The machine scans the pattern and aligns the FINE Cartridge automatically.



Note

If you select <Head alignment print> in step 2-(2), the machine prints the current FINE Cartridge Alignment setting.

Cleaning Your Machine

This section describes the necessary cleaning procedures for your machine.

Caution

- Be sure to turn OFF the power and disconnect the power cord before cleaning the machine.
- Do not use tissue paper, paper towels, or similar materials for cleaning; they can stick to the components or generate static charges. Use a soft cloth to avoid scratching the components.
- Never use volatile liquids such as thinners, benzene, acetone, or any other chemical cleaner to clean the machine; these can damage the machine's components.

■ **Cleaning The Platen Glass And Document Cover**

Wipe the Platen Glass (A), and the inner side of the Document Cover (white area) (B) with a clean, soft, lint-free cloth moistened with water. Then wipe with a clean, soft, dry, lint-free cloth making sure not to leave any residue, especially on the Platen Glass. If you have trouble getting the scanning area clean, wipe with diluted mild detergent (for dish washing).

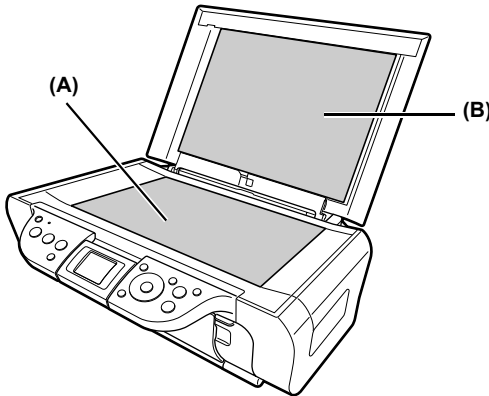

■ **Cleaning The Exterior**

Wipe the machine's exterior with a clean, soft, lint-free damp cloth.

■ Cleaning The Roller

Clean the paper feed rollers if paper is not fed properly. Cleaning the paper feed rollers will wear the rollers, so perform this only when necessary.

1 Press [ON/OFF] to turn ON the machine, then remove any paper from the Auto Sheet Feeder.

2 Clean the paper feed rollers.

(1) Display the Maintenance screen.

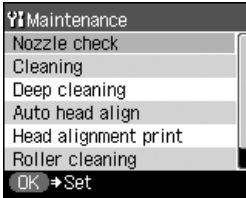

(2) Use [▲] or [▼] to select <Roller cleaning>, then press [OK].
The confirmation screen is displayed.

(3) Use [▲] or [▼] to select <Yes>, then press [OK].
The paper feed rollers are cleaned.

3 Repeat step 2 twice.

4 Open the Paper Output Tray.

5 Load three or more of A4- or Letter-sized paper in the Auto Sheet Feeder.

6 Repeat step 2 three times.

The sheet of paper is automatically fed in and then out of the machine.

Note

If there are no signs of improvement after performing three times, contact a Canon service representative.

■ Cleaning The Bottom Plate

If the printed paper is smudged, the inside of the machine may be dirty. Periodic cleaning of certain parts on the inside of your machine is recommended to maintain a high standard of printing quality.

The parts can be cleaned in the following ways:

See “Cleaning The Bottom Plate” on page 95.

See “Cleaning The Protrusions Inside The Machine” on page 96.

- 1** Ensure that the machine is turned ON and there is no paper loaded in the Auto Sheet Feeder.
- 2** Take a sheet of A4- or Letter- sized plain paper and fold it in half widthwise. Then, open the paper.
- 3** Load it into the Auto Sheet Feeder with the opened side facing up.

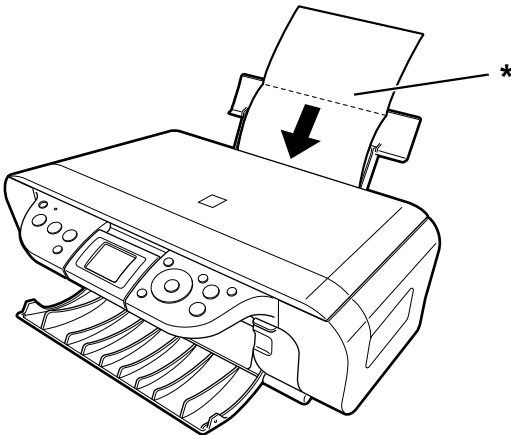

* Insert the paper open side up.

4 Start Bottom Plate Cleaning.

- (1) Display the Maintenance screen.

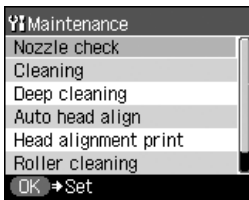

- (2) Use [▲] or [▼] to select <Bottom plate cleaning>, then press [OK].
(3) When the confirmation message is displayed, select <Yes> and press [OK].
The paper is ejected.

Inspect the discharged paper. If dust or dirt can be seen on the paper, repeat the cleaning process.

Note

If the discharged paper still appears dirty after you have run this Cleaning process, the inside of your machine is probably extremely dirty.

Clean the inside of the machine in accordance with the following directions.

See "Cleaning The Protrusions Inside The Machine" on page 96.

■ Cleaning The Protrusions Inside The Machine

If the protrusions inside the machine are stained, wipe ink off the protrusions using a swab or something similar.

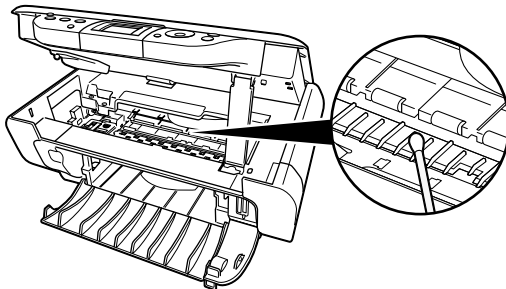

 **Important** Before cleaning, be sure to turn OFF the machine.

 **Caution** Do not touch the transparent film (A), film cable (B), ink absorber (sponge part) (C), or any metal parts.

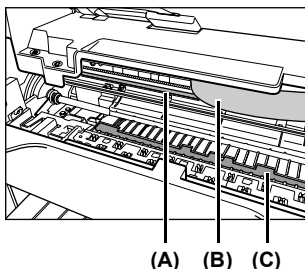

Chapter 11

Troubleshooting

This chapter provides troubleshooting tips for problems you may encounter when using the machine.

Note

This section provides troubleshooting tips for the most common printing problems. If you cannot find appropriate tips for your problem, refer to the on-screen manuals.

An Error Message Is Displayed On The LCD (See page 98)

Cannot See The Display Properly On The LCD/Cannot See The Display On The LCD (See page 99)

Ink Does Not Come Out/ Printing Is Blurred/Colors Are Wrong/White Streaks/Straight Lines Are Misaligned/Cannot Print To End Of Job (See page 99)

Back Of Paper Is Smudged/Paper Does Not Feed Properly/Printed Surface Is Scratched (See page 103)

Paper Jams (See page 106)

Cannot Print Properly From A Photo Index Sheet (See page 107)

An Unintended Language is Displayed on the LCD (See page 107)

Cannot Print Properly From The Digital Camera (See page 108)

Cannot Print Properly Through Wireless Communication (See page 110)

Cannot Install The MP Driver (See page 111)

Cannot Connect To PC Properly (See page 112)

Problems With Scanning (See page 113)

An Error Message Appears On The Screen (See page 117)

Windows

For Windows Users (See page 119)

If You Cannot Solve The Problem (See page 120)

Windows

● If an error occurs when the machine is connected to a computer

When an error occurs in printing such as the machine is out of paper or paper jams, a troubleshooting message is displayed automatically. Take the appropriate action described in the message.

The message may vary depending on the version of your Windows operating system.

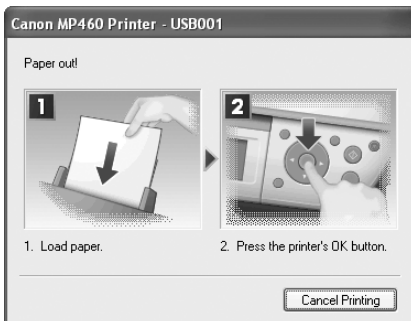

An Error Message Is Displayed On The LCD

If an error message is displayed on the LCD, take the corresponding countermeasure described below.

Message	Action
There are no photos in memory card.	<ul style="list-style-type: none"> ● There are only invalid images on the memory card. ● Photo data edited/processed on a computer should be printed from the computer, not from the camera.
There is no paper.	Reload the paper correctly and press [OK].
The paper is jammed.	If paper has jammed in the machine, clear the jam, reload the paper in the machine correctly and then press [OK].
Ink has run out. U041	<p>Replace the FINE Cartridge, and close the Scanning Unit.</p> <p>If printing is not finished yet, just press [OK] on the machine to continue printing in the “no ink” state.</p> <p>Replace the FINE Cartridge with a new one as soon as possible after printing finishes. The machine may be damaged if printing is continued under the ink out condition.</p>
The following ink cartridge cannot be recognized. U051 U052 U053 U059	The FINE Cartridge may not be installed properly, or the Cartridge may not be the compatible with this machine. Install the appropriate FINE Cartridge. If lines are misaligned or the resulting output is not satisfactory, carry out the FINE Cartridge Alignment.
Some ink cartridges are not installed in place. U075 U076	Confirm that the FINE Cartridges are installed in the appropriate positions. See “Replacing A FINE Cartridge” on page 75.
The ink absorber is almost full. Press [OK] to continue printing. Contact the service center.	The ink absorber is almost full. Printing will no longer be possible once the ink absorber is full. Contact the service center immediately. Press [OK] to continue printing.
Incompatible device detected.	<p>Depending on the model or brand of your device, you may have to select a print mode compliant with PictBridge before connecting the device.</p> <p>You may also have to turn ON the device or select Play mode manually after connecting the device to the machine. Perform the necessary operations according to the instruction manual supplied with your device.</p> <p>If the error is still unresolved, there is a possibility that you are using a digital camera or digital video camcorder that is not supported by this machine. Use a digital cameras or digital video camcorder compatible with this machine.</p>
Auto head align has failed.	<p>Make sure all required boxes on the head alignment sheet are filled in, and that the sheet is set in the correct position and orientation on the Platen Glass.</p> <p>If the machine is connected to the computer, you can align the FINE Cartridge using the MP Driver. Follow the procedures described in the <i>Printer Driver Guide</i>.</p>
The following ink may have run out. U162	This FINE Cartridge may have previously been used, or the ink may have run out. The function for detecting the remaining ink level will be disabled since the remaining ink level cannot be correctly detected. If you want to continue printing without this function, press [OK]. Canon recommends to use new genuine Canon Cartridges in order to obtain optimum qualities.

Message	Action
The following ink cartridge cannot be recognized. U140	The FINE Cartridge may not be compatible with this machine. Install the appropriate FINE Cartridge. If lines are misaligned or the resulting output is not satisfactory, carry out the FINE Cartridge Alignment.
Printer error.	An error requiring servicing might have occurred. Turn OFF the machine, and unplug the power cord of the machine from the power supply. After a while, plug the power cord of the machine back in and turn ON the machine. If the same error occurs, contact a Canon service representative.

 **Note**

If the ON/OFF Lamp (green) and Alarm Lamp (orange) flash alternately, disconnect the USB cable from the machine, and then turn the machine OFF and then unplug the machine from the power supply for a while. Plug the machine back in and turn the machine back ON.

If the problem remains, contact a Canon service representative.

Cannot See The Display Properly On The LCD/ Cannot See The Display On The LCD



Cause	Action
Cannot see the display properly on the LCD./The display on the LCD is illegible.	Adjust the contrast of the LCD in the <Adjust contrast> menu in the <Maintenance/settings>. See “Other Settings” on page 73.
Cannot see the display on the LCD.	<ul style="list-style-type: none"> ● You have not pressed [ON/OFF]. The machine will power ON and the LCD will display a message when you connect the power cord and press [ON/OFF]. ● The LCD may be in power saver mode. Press any button on the Operation Panel except for [ON/OFF] to restore the display.

Ink Does Not Come Out/Printing Is Blurred/Colors Are Wrong/White Streaks/Straight Lines Are Misaligned/Cannot Print To End Of Job

Cause	Action
FINE Cartridge is empty.	Replace the FINE Cartridge, and close the Scanning Unit. If printing is not finished yet, just press [OK] on the machine to continue printing in the “no ink” state. Replace the FINE Cartridge with a new one as soon as possible after printing has finished. The machine may be damaged if printing is continued under the ink out condition. See “Replacing A FINE Cartridge” on page 75.
FINE Cartridge is not installed correctly.	Open the Scanning Unit and make sure that the correct FINE Cartridge is inserted in each position. See “Replacing A FINE Cartridge” on page 75.

Cause	Action
Incorrect paper type.	<p>When printing directly from a digital camera, on the Operation Panel, confirm that the <Media Type> selected matches the paper loaded.</p> <p>When printing from a computer, check the following.</p> <p>Windows</p> <p>On the [Main] tab of the printer driver, ensure that the [Media Type] selected matches the paper loaded.</p> <p>Macintosh</p> <p>In the [Print] dialog box of the printer driver, select [Quality & Media] from the pop-up menu, and then ensure that the [Media Type] selected matches the paper loaded.</p>
FINE Cartridge nozzles clogged or shifted.	<p>Print the nozzle check pattern to check for uneven ink output.</p> <p>See “Printing The Nozzle Check Pattern” on page 85.</p> <ul style="list-style-type: none"> ● Ink supply is uneven. <p>See “FINE Cartridge Cleaning” on page 89.</p> <p>See “FINE Cartridge Deep Cleaning” on page 90.</p> <ul style="list-style-type: none"> ● If straight lines are shifted. <p>See “Aligning The FINE Cartridge” on page 91.</p>
Print Quality is not set properly.	<p>Be sure to set the [Print Quality] setting to [High] in Windows, or [Fine] in Macintosh.</p> <p>Windows</p> <ol style="list-style-type: none"> 1. Open the printer properties dialog box. 2. On the [Main] tab, click [High] for the [Print Quality] setting. <p>When you cannot choose the [High] setting or when the print quality does not improve, select [Custom], click [Set] and then adjust the Quality bar for higher print quality.</p> <p>Macintosh</p> <ol style="list-style-type: none"> 1. Open the [Print] dialog box. 2. Select [Quality & Media] from the pop-up menu and then click [Detailed Setting]. 3. Drag the [Print Quality] slide bar to the [Fine] end.
Media not loaded printside up.	Check that your paper is loaded with the correct print side facing up.
The paper stack exceeds the capacity of the Auto Sheet Feeder.	If the paper stack exceeds the Load Limit Mark, or exceeds the capacity of the Auto Sheet Feeder, reduce the amount of paper. See “Recommended Paper” on page 17.
There is some foreign matter in the Auto Sheet Feeder.	Check and remove any foreign matter.
The Paper Output Tray is closed.	Open the Paper Output Tray.

Cause	Action
<p>Unnecessary print jobs are queued./ Computer problems.</p>	<p>Restart your computer. It may solve the problem.</p> <p>Delete an undesired print job, if there is any. Use the Canon IJ Status Monitor in Windows or [Printer Setup Utility] (or [Print Center]) in Macintosh for the deletion.</p> <p>Windows</p> <ol style="list-style-type: none"> 1. Open the printer properties dialog box. 2. Click the [Maintenance] tab and then click [View Printer Status]. 3. Click [Display Print Queue]. 4. Select [Cancel All Documents] in the [Printer] menu. <p>Note</p> <p>In Windows XP or Windows 2000, the print jobs may not be selected.</p> <ol style="list-style-type: none"> 5. When the confirmation message is displayed, click [Yes]. <p>The print job is deleted.</p> <p>Note</p> <p>In Windows Me or Windows 98, click to select undesired documents and select [Purge Print Documents] in the [Printer] menu.</p> <p>Macintosh</p> <ol style="list-style-type: none"> 1. Select [Utilities] from the [Go] menu. 2. Double-click the [Printer Setup Utility] icon. When using Mac OS X v.10.2.8, double-click the Print Center icon. 3. Double-click the name of your machine displayed under [Name] in the [Printer List]. 4. Click to select undesired documents and click  . The print job is deleted.
<p>Memory is insufficient.</p>	<p>Increase available memory by closing any other applications currently running.</p> <p>If you still cannot print, restart Windows and try printing again.</p>
<p>The machine has been printing continuously over a long period.</p>	<p>If so, the FINE Cartridge will overheat. To protect the FINE Cartridge, printing will stop temporarily and resume after a period of time. Interrupt printing when appropriate, turn OFF the machine, and wait at least 15 minutes.</p> <p>Caution</p> <p>The area around the FINE Cartridge nozzles may become extremely hot. Do not under any circumstances touch it.</p>
<p>You are printing high-resolution documents such as photographs or illustrations.</p>	<p>If you are printing high-resolution documents, processing the data will take time, and printing will appear to have stopped. Wait until data is processed. If you are printing a document with a large printing area (with small margins) or are printing multiple sets, printing may stop to allow the ink time to dry.</p>
<p>Incorrect page size is selected.</p>	<p>Ensure that the page size setting matches the size of the paper loaded in the machine:</p> <ul style="list-style-type: none"> ● Check the paper size setting from within your application to ensure that it matches the size of the paper loaded. ● Check [Page Size] on the [Page Setup] tab in the printer properties dialog box of the printer driver (Windows) or [Paper Size] in the [Page Setup] dialog box of the printer driver (Macintosh) to ensure that it matches the size of the paper loaded.

Cause	Action
 The size of the print data is too large.	Check the size of the print data. For Windows XP and Windows 2000, if the size of the data is too large, part of it may be lost. When the spool format is EMF, follow the procedure below. <ol style="list-style-type: none"> 1. Open the printer properties dialog box. 2. On the [Page Setup] tab, click [Print Options]. 3. Select the [Reduce spool data size] check box, and click [OK]. <p> Note</p> When Reduce spool data size is set, the print quality may be degraded.
The hard disk does not have enough available space.	You may need to increase the amount of free space on the disk by deleting any unnecessary files.

■ When Copying

Cause	Action
The document is not loaded correctly.	Check that the document is loaded correctly on the Platen Glass. See "Loading Documents" on page 15.
The quality (image quality) displayed on the LCD is not suitable for the document.	Set the image quality suitable for the document. See "Print Setting Items" on page 28.
The document is not loaded with the side to be copied face down.	When loading the document on the Platen Glass, the side to be copied should be face down.
The document or photograph set on the Platen Glass was printed from your machine.	Image quality may be poor if you copy a printed document or photograph. Instead, reprint the photograph directly from the digital camera, or the document from your computer.
The Platen Glass or inner side of the Document Cover is dirty.	Clean the Platen Glass or inner side of the Document Cover. See "Cleaning The Platen Glass And Document Cover" on page 93.

Back Of Paper Is Smudged/Paper Does Not Feed Properly/Printed Surface Is Scratched

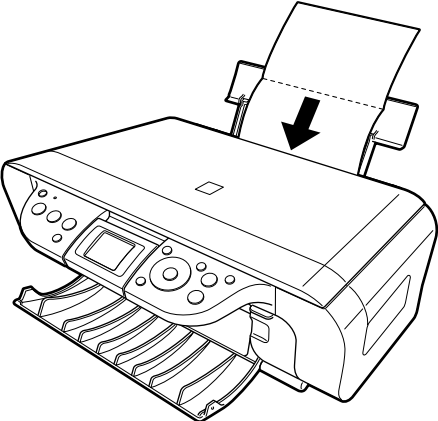
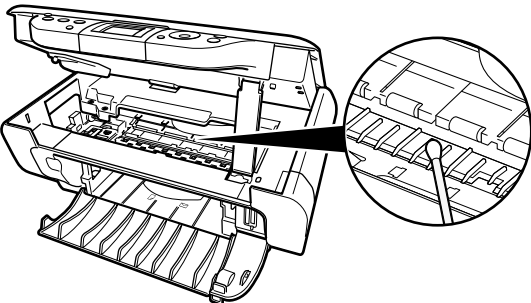
Cause	Action
Inside of the machine is dirty.	<p>If the inside of the machine is dirty, the printed paper may be smudged. Follow the steps described below to clean the inside of the machine.</p> <ol style="list-style-type: none">1. Ensure that the machine is turned on and there is no paper loaded in the Auto Sheet Feeder.2. Place A4/Letter-sized plain paper in landscape orientation, horizontally fold it in half.3. Unfold the paper, and load the paper in the Auto Sheet Feeder with the inverted-V edge down.  <ol style="list-style-type: none">4. Select <Bottom plate cleaning> from <Maintenance>.5. Select <Yes> on the Bottom plate cleaning confirmation screen and then press [OK]. <p>Paper will be ejected.</p> <p>If protrusions inside the machine are stained, wipe ink off the protrusions using a swab or such like.</p>  <p>⚠ Important Before cleaning, be sure to turn OFF the machine.</p>

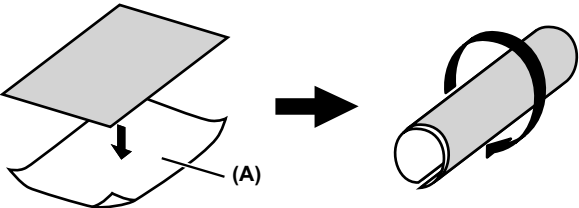
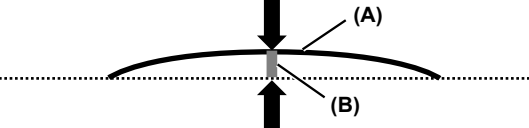
Cause	Action
Paper feed roller is dirty.	<p>Follow the steps described below to clean the paper feed rollers.</p> <ol style="list-style-type: none"> 1. Ensure that the machine is turned ON and there is no paper loaded in the machine. 2. Select <Roller cleaning> from <Maintenance>. 3. Select <Yes> on the Roller cleaning confirmation screen and then press [OK]. <p>The paper feed roller will rotate as it cleans.</p> <ol style="list-style-type: none"> 4. Repeat this operation twice. 5. Load three or more sheets of A4/Letter-sized plain paper lengthways in the Auto Sheet Feeder. 6. Select <Roller cleaning> from <Maintenance>. 7. Select <Yes> on the Roller cleaning confirmation screen and then press [OK]. <p>The paper that is loaded in the machine will feed through the machine and be ejected.</p> <ol style="list-style-type: none"> 8. Repeat Steps 5 to 7 three times.
Inappropriate paper type is used.	<ul style="list-style-type: none"> ● Check to see if the paper you are printing on is too thick. See “Paper Types You Cannot Use” on page 16. ● Note that smudging may occur at the top and bottom edges of the paper when using Borderless Printing. Ensure that the paper you are using is compatible with Borderless Printing.
Thick paper is used.	<p>When printing on thick paper, set the Paper Thickness Lever to the right. This widens the gap between the FINE Cartridge and the paper. Try this maneuver if the printed surface is scratched.</p>
Media is curled.	<p>If all four corners or the printing surface of the paper is curled, the paper may become dirty or may not feed properly. Use the paper after correcting paper curl as follows.</p> <ol style="list-style-type: none"> 1. Place the printing surface face up (A), and cover it with a sheet of non-printing regular paper to avoid damaging the surface. 2. Roll up the paper in the direction opposite to the paper curl as per the figure below.  <ol style="list-style-type: none"> 3. Check the printing paper to confirm if the paper curl is eliminated to within approximately 2 to 5mm / 0.08 to 0.2 in (B).  <p>It is recommended to print on curl-corrected paper one sheet at a time.</p>

Cause	Action
The media type is not selected correctly in the printer driver.	<p>Windows</p> <p>On the [Main] tab of the printer driver, ensure that the [Media Type] selected matches the paper loaded.</p> <p>Macintosh</p> <p>In the [Print] dialog box of the printer driver, select [Quality & Media] from the pop-up menu, and then ensure that the [Media Type] selected matches the paper loaded.</p>
Paper is loaded incorrectly.	<p>Load in the portrait orientation regardless of the print direction of the Auto Sheet Feeder.</p> <p>Ensure that paper is loaded correctly. Slide the paper guides against the paper stack.</p>

■ Paper Curls/Ink Blots

Cause	Action
Paper being used is too thin.	Use Photo Paper Pro or other Canon genuine media to print images that have a high color saturation. See “Paper Types You Cannot Use” on page 16.
The media type is not selected correctly on the Operation Panel.	Ensure that the media type selected on the Operation Panel matches that of the paper loaded.

Paper Jams

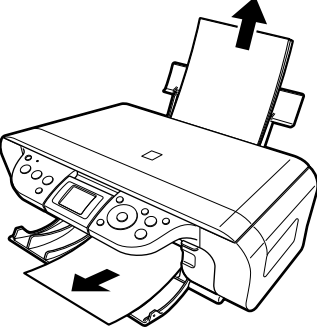
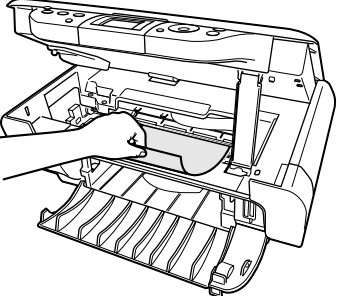
Cause	Action
<p>Paper jams in the paper output slot/ Auto Sheet Feeder. Landscape Credit Card-sized paper jams inside the machine.</p>	<p>Remove the paper according to the following procedure.</p> <ol style="list-style-type: none">1. Slowly pull the paper out, either from the Auto Sheet Feeder or from the paper output slot, whichever is easier.  <ul style="list-style-type: none">● If the paper tears and a piece remains inside the machine, open the Scanning Unit and remove it. Be careful not to touch the components inside the machine at this time. After removing all paper, close the Scanning Unit, turn the machine OFF and turn it back ON.  <ol style="list-style-type: none">2. Reload the paper into the machine and press [OK]. <ul style="list-style-type: none">● If you cannot pull the paper out, turn the machine OFF and turn it back ON. The paper will be ejected automatically.● If you have turned OFF the machine in step 1, you will need to retry printing, because this operation cancels any print jobs in progress. <p>If you cannot remove the paper or the paper tears inside the machine, or if the paper jam error persists after removing the paper, contact a Canon service representative.</p> <p>⚠ Important You cannot load Credit Card-sized paper in the landscape orientation.</p>

Cannot Print Properly From A Photo Index Sheet

Cause	Action
<Failed to scan Photo Index Sheet.> is displayed.	Make sure all required boxes on the Photo Index Sheet are filled in, and that the sheet is set in the correct position and orientation on the Platen Glass. See "Printing By Using The Photo Index Sheet" on page 42.

An Unintended Language Is Displayed On The LCD.

Cause	Action
The language you want to be displayed is not selected.	Select the language you want to be displayed following the procedure below. 1. Press [Copy] to enter the copy mode. 2. Press [Menu]. 3. Press [▶], then press [OK]. 4. Press [▶], then press [OK]. 5. Press [▼] three times, then press [OK] to display Language Selection screen. If the Bluetooth unit is connected to the machine, press [▼] four times, and then press [OK]. 6. Press [▲] or [▼] to select the language you want to be displayed, then press [OK].

Cannot Print Properly From The Digital Camera

The following are possible errors that may occur when printing directly from a digital still camera or digital video camcorder*, and the countermeasures to eliminate them.

*Hereafter, digital still cameras and digital video camcorders are collectively called a digital camera or camera.

Note

- PictBridge-compatible digital cameras can be connected to your machine for direct printing.
- This section describes errors that may be indicated on Canon-brand PictBridge-compatible cameras. The error messages and operations may vary depending on the camera you are using. If you are using a non-Canon PictBridge-compatible camera and not sure how to clear the printer error from the camera, confirm the message displayed on the LCD of the machine and clear the error. For clearing errors from the machine, see “An Error Message Is Displayed On The LCD” on page 98.
- A communication time out occurs if printing takes a long time or if it takes too long to send the data. This may stop the printing. In such cases, disconnect the cable between the machine and the camera, and reconnect the cable between the machine and the camera. Then, turn the camera on, if it has not automatically turned itself on. If the problem is still unresolved, select some other photo and check if it can be printed or not.
- Your PictBridge-compatible device may need to be switched to printing mode before it is connected to the machine, depending on the model of the device. Also, it may need to be turned on manually or switched to replay mode after being connected to the machine. Refer to the instruction manuals supplied with your camera and take the necessary steps before connection.
- The FINE Cartridge nozzles may be clogged if printing becomes faint or the colors are incorrect. See “When Printing Becomes Faint Or Color Is Incorrect” on page 84.
- If the paper is curled or its surface is scratched during printing, make sure that you are using the correct type of paper.
- For errors indicated on the camera and their solutions, also refer to the user’s manual of the camera. For other problems associated with a digital camera, contact the manufacturer of the camera.

Error message on camera	Action
Printer in use/Printer warming up	Photos are being printed from the computer. Wait until printing ends. If the machine is warming up, wait until warm-up ends.
No paper/Paper error	Load paper in the Auto Sheet Feeder and press [OK] on the machine. If the Paper Output Tray is closed, open it. Printing is resumed.
Paper jam	Remove the jammed paper, load new paper, and press [OK] on the machine and retry printing.
Printer cover open	Close the Scanning Unit on the machine.
No print head	The FINE Cartridge may not be installed properly, or the Cartridge may not be the compatible with this machine. Install the appropriate FINE Cartridge. If lines are misaligned or the resulting output is not satisfactory, carry out the FINE Cartridge Alignment.

Error message on camera	Action
<p>Waste tank (ink absorber) full / Ink absorber full</p>	<p>This error message indicates that the ink absorber is nearly full. The machine has a built-in ink absorber to hold the ink used during FINE Cartridge cleaning, for example. You can continue printing by selecting Continue**1 on the display on your camera. However, because printing is disabled once the ink absorber becomes completely full and until the ink absorber is replaced, you are recommended to contact a Canon service representative as soon as possible.</p>
<p>No ink</p>	<ul style="list-style-type: none"> ● Prepare a new FINE Cartridge. Select Continue**1 in the display on your camera to resume printing. ● Replace the FINE Cartridge and close the Scanning Unit. If printing is in progress and you want to continue printing, press [OK] with the FINE Cartridge installed. Then printing can continue under the ink out condition by selecting Continue**1 on the display on your camera. Replace the empty FINE Cartridge immediately after this printout. The machine may be damaged if printing is continued under the ink out condition. ● The FINE Cartridge may not be the compatible with this machine. Install the appropriate FINE Cartridge.
<p>Printer error</p>	<p>An error requiring servicing might have occurred. Disconnect the cable between the machine and the camera, turn OFF the machine, and unplug the power cord of the machine from the power supply. After a while, plug the power cord of the machine back in, turn ON the machine, and then reconnect the camera to the machine. If the same error occurs, contact a Canon service representative.</p>

**1 To resume printing, you can press [OK] on the machine instead of selecting Continue.

Cannot Print Properly Through Wireless Communication

The following are some causes of problems that may occur when printing via infrared communication.

For problems when printing via Bluetooth communication, refer to the *Bluetooth User's Guide*.

Cause	Action
The installation place, distance, and/or angle is improper.	When printing via infrared communication, confirm that the infrared communication ports on both the machine and the mobile phone are facing each other at the proper angle and distance, and that there is nothing to block the communication between them, and then try printing again. The proper distance and angle for communication vary depending on the specifications of your mobile phone and computer and on the external environment. Place the mobile phone within 20 cm (7.87 in.) of the machine for proper communication.
During infrared communication, infrared rays were interrupted or another infrared communication device is operating nearby.	If infrared communication between the infrared ports of the machine and the mobile phone is interrupted by any obstacle for about ten seconds or longer during printing, the paper on which the data is being printed is ejected and the machine is reset. Remove the obstacle and retry printing. If an infrared communication device is operating nearby, interference can occur and the document may fail to print to the end. While printing a document through infrared communication, do not operate another infrared communication devices, such as the remote controller for a TV, nearby.
The version of the infrared communication port being used is not compatible with IrDA.	The infrared communication function of this machine is only compatible with mobile phones with IrDA-compliant infrared communication ports. Printing through infrared communication cannot be performed by any other types of mobile phones.

Cannot Install The MP Driver

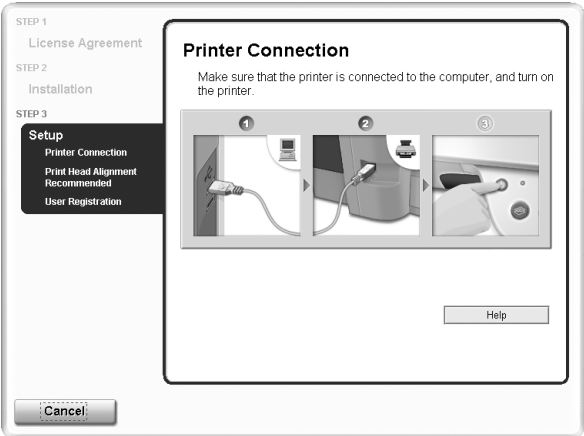
Cause	Action
<p>Windows Unable to proceed beyond the Printer Connection screen.</p>	<p>Reinstall the MP driver.</p>  <p>1. Click [Cancel] on the [Printer Connection] screen. 2. Click [Start Over] on the [Installation Failure] screen. 3. Click [Back] on the screen that appears next. 4. Click [Exit] on the [Welcome] screen, then remove the CD-ROM. 5. Turn the machine and the computer OFF. 6. Restart the computer. 7. Carefully follow the procedures described in the <i>Easy Setup Instructions</i> and reinstall the driver.</p>
<p>Other applications (including anti-virus software) are running in the background.</p>	<p>Other applications opened on your computer can interfere with the installation routine. Close all open software applications before reinstalling the MP driver.</p>
<p>Installation does not start automatically when the Setup CD-ROM is inserted into the drive.</p>	<p>Windows Click [Start], select [My Computer] and then double-click the CD-ROM icon. For non-Windows XP users, open the [My Computer] window and then double-click the CD-ROM icon.</p> <p>Macintosh Double-click the CD-ROM icon on your desktop to start installation. If the CD-ROM icon is not displayed on the desktop, there is a problem with the CD-ROM. Contact a Canon service representative.</p>
<p>You have a defective Setup CD-ROM.</p>	<p>If you have a defective Setup CD-ROM, please consult your sales or service representative.</p> <p>Windows Make sure the CD-ROM is readable from Windows Explorer.</p> <p>Macintosh Reconfirm that the CD-ROM icon is displayed when you insert the CD-ROM.</p>

Cause	Action
Installation procedure not followed correctly.	<p>Follow the <i>Easy Setup Instructions</i> packaged with your machine for proper MP driver installation.</p> <p>If the MP driver was not installed correctly, uninstall the MP driver, and restart your computer. Try to reinstall the MP driver.</p> <p>Windows</p> <p>If the installer was forcibly terminated due to an error, Windows may be unstable. Remove the CD-ROM from the CD-ROM drive and restart your computer.</p> <p>Reinstall the MP driver.</p>

Cannot Connect To PC Properly

■ Printing Speed Is Slow/USB 2.0 Hi-Speed Connection Does Not Work

Cause	Action
Your environment is not fully compatible with USB 2.0.	<p>If your environment is not fully compatible with USB 2.0, the machine will operate at the lower speed provided under USB 1.1. In this case, the machine operates properly but printing speed may be slower due to the communication speed.</p> <p>Check the following to ensure that your Computer environment supports USB 2.0 Hi-Speed connections.</p> <ul style="list-style-type: none"> ● The USB port on your Computer supports USB 2.0 Hi-Speed connection. ● Both the USB cable and USB hub support USB 2.0 Hi-Speed connection. <p>Be sure to use a certified USB 2.0 Hi-Speed cable. You are recommended to use a cable no longer than 3 meters.</p> <ul style="list-style-type: none"> ● Your Computer supports the USB 2.0 Hi-Speed connection. <p>Obtain the latest version of the USB 2.0 Hi-Speed driver and install it on your Computer.</p> <ul style="list-style-type: none"> ● The USB 2.0 Hi-Speed driver operates properly. <p>Obtain the latest version of the USB 2.0 Hi-Speed driver and install it on your Computer.</p>

Windows

■ When You Connect To A Computer Running Windows XP, The Screen Shows The Warning Message “High-Speed USB Device Plugged Into Non-High-Speed USB Hub”

Cause	Action
You connect to a computer that does not support USB 2.0 Hi-Speed.	<p>Your environment is not fully compatible with USB 2.0.</p> <p>See “Printing Speed Is Slow/USB 2.0 Hi-Speed Connection Does Not Work” on page 112.</p>

Problems With Scanning

■ Scanner Won't Work

Cause	Action
Machine is not identified.	Restart the computer. It may solve the problem. Then confirm that the machine is identified.

■ ScanGear Won't Start

Cause	Action
Scanner driver (ScanGear) is not installed.	Set the "Setup CD-ROM" in your computer and install ScanGear.
Machine may not be selected.	Select your machine following the directions in Scanning with ScanGear in Initiating a Scan.
The application program used does not support calling up ScanGear.	Start ScanGear from within a TWAIN-compatible program.
An error message appears and the ScanGear window fails to appear.	<ul style="list-style-type: none"> ● Reattach the USB cable. Only use a certified USB 2.0 Hi-Speed cable. ● Attach the USB cable to a different USB port on the computer itself (not a hub). ● If a USB hub is used for the connection, do not use it. Attach the cable directly to a USB port on the computer itself (not the hub). ● The machine may not be selected. Select your machine following the directions in Scanning with ScanGear in Initiating a Scan. ● Be sure to start ScanGear from within a TWAIN-compatible program.

■ Computer Stops Operating During Scanning

Cause	Action
Output Resolution set too high.	Reboot the computer, lower the Output Resolution and rescan. (See the <i>Scanning Guide</i>)
Insufficient hard disk space.	<ul style="list-style-type: none"> ● When scanning large originals at a high resolution, an error may occur if there is insufficient hard disk space. Check that the hard disk has sufficient free space, and rescan. ● When scanning large originals at a high resolution, the progress bar may stay at 0% depending on your computer. Set a smaller scanning area or a lower resolution, and rescan.
Multiple devices connected to the USB port.	Disconnect all other devices but the machine from the port.

■ Scan Quality Is Poor (Poor Image Displayed On The Monitor)

Cause	Action
Incorrect scan settings.	Rescan with adjusted settings. (See the <i>Scanning Guide</i>)
Specification of the application program.	Some application programs do not display the image clearly if the image is too small. Set the view mode to 100%.
Moiré appears.	Select [Magazine (Color)] for Select Source in the Simple Mode or turn on the [Descreen] option in the Advanced Mode of ScanGear. Turn off the [Unsharp Mask] function if the moiré effect is still too strong even when the Descreen option is on. (See the <i>Scanning Guide</i>)
Inappropriate display settings.	<p>Windows</p> <p>Set the display settings on your computer to Medium (16 bit) or higher.</p> <p>Macintosh</p> <p>In the [System Preferences] dialog, click the [Displays] icon and select the [Display] tab. Set the [Colors] list box to [Thousands] or a higher setting.</p>
Dirty Platen Glass or Document Cover.	Clean the Platen Glass or the Document Cover of the machine, taking special care not to press strongly on the Platen Glass.
The status of the original is poor.	<p>Scan with certain functions such as [Reduce Dust and Scratches], [Fading Correction] or [Grain Correction] in the Image Settings section of the Advanced Mode of ScanGear.</p> <p>Note</p> <p>If the printout of an image does not appear satisfactory or the same as what you see on the monitor, you may need to change the machine's settings, or the machine itself may have some problems.</p>
The color of a preview image or a scanned image is different from the original when scanning an image with a plain background like the blue sky.	<p>Set [Auto Tone] to [OFF] in ScanGear, and rescan.</p> <p>For details, refer to the <i>Scanning Guide</i>.</p>

■ Parts Of Image Missing Or Surrounded By Extra White Areas

Cause	Action
Scan area was specified larger than the original.	<p>Specify the scan area appropriately.</p> <p>If you click the Auto crop button of the ScanGear, the scan area is adjusted automatically to match the size of the original. When scanning an original surrounded by white borders such as a photo print, or if you otherwise want to specify a custom scan area, specify the scan area manually. Refer to the <i>Scanning Guide</i> for details on manual scan area specification.</p>

■ Trouble scanning with Multi-Scan or Multi-Crop function

Cause	Action
The original is positioned outside the supported area.	<p>Check the position of the original on the Platen Glass. Observe the following when using the Multi-Scan or Multi-crop function.</p> <ul style="list-style-type: none"> ● Up to 10 originals can be set at once. ● There should be a gap of at least 0.4" / 10 mm between the edge of the Platen Glass and originals. ● Leave at least 0.4" / 10 mm between the originals. ● If an original is slightly crooked on the Platen Glass within 10 degrees of true-the image will be automatically straightened. ● Originals that are irregularly shaped, close-cropped photos or smaller than 1.2" / 30 mm cannot be detected correctly.
Error arising from application software specifications.	Some application softwares do not support multiple image scanning. Scan each item individually without using the Multi-Scan or Multi-Crop function.

■ Slow Scanning Speed

Cause	Action
Resolution is set higher than necessary.	To view the image on a monitor, set the Output resolution to 75 dpi. To print, set the Output resolution to a value such as 300 dpi.
The descreen function is on.	Turn the [Descreen] function off. (See the <i>Scanning Guide</i>)

■ “There is not enough memory.” Message Is Displayed

Cause	Action
There is not enough memory to continue scanning.	Exit any applications that are running, and try to run this program again.

■ Scanned Image Is Not Displayed Properly

Cause	Action
Scanned image prints out enlarged (reduced).	Set the printing size in the application program. Example: ArcSoft PhotoStudio 1. With the image in the selected state, click the [File] menu and select [Print]. 2. Move the print size slider left or right in the Print dialog to adjust the printing size. The preview image to the left will change size accordingly.
Scanned image enlarged (reduced) on the computer monitor.	<ul style="list-style-type: none"> ● Change the display setting in the application software.  <ul style="list-style-type: none"> ● It may not be possible to reduce the size of images opened in the Paint or Imaging programs. Open the image in an application program supplied with the machine instead. See the on-screen manuals for each application program for the detailed procedures. ● Change the resolution setting in the scanner driver and rescan. The higher the resolution, the larger the resulting image will be. ● Some application programs do not display clear images at small image display settings. Set the scale to 100%.
Scanned image won't open.	The file name extension is not supported by the application program. Rescan the image using an application program, such as ArcSoft PhotoStudio, and change the file name extension when saving the image. See the on-screen manuals for each application program for the detailed procedures.

■ Trouble scanning with MP Navigator

Cause	Action
The original may not be scanned correctly when [Document Size] is set to [Auto Detect].	Set the [Document Size] to the actual size of the original, and scan it again. If the size you need cannot be set, scan to a larger size and trim it. For more information, refer to the <i>Scanning Guide</i> .

■ Image position and size incorrect when scanning from the machine's operation panel

Cause	Action
MP Navigator settings do not match the originals.	Set the MP Navigator [Document Type] and [Document Size] to match those of the originals being scanned. For more information, refer to the <i>Scanning Guide</i> .

An Error Message Appears On The Screen

■ Service Error 5100 is Displayed

Cause	Action
Movement of the FINE Cartridge Holder is blocked.	Clear the paper jam or foreign object that is preventing the FINE Cartridge Holder from moving, cancel printing from your computer, then turn OFF the machine and turn it back ON again.

Windows

■ Writing Error/Output Error/Communication Error

Cause	Action
Machine is not ready.	Ensure that the ON/OFF lamp on the Operation Panel is on. If the lamp on the Operation Panel is off, turn the machine ON. If the Alarm lamp is on, an error may have occurred in the machine. For details on how to resolve the error, refer to "An Error Message Is Displayed On The LCD" on page 98.
Paper is not loaded.	Load paper and press [OK]. If this error (Paper is not loaded) is ignored for a certain period of time, an additional message may be displayed.
Printer port setting does not match the interface connected to the machine.	Check the printer port settings. 1. Click [Start] and select [Control Panel], [Printers and Other Hardware], and then [Printers and Faxes]. For non-Windows XP, click [Start], select [Settings], and then [Printers]. 2. Select the icon of your machine. 3. Open the [File] menu and select [Properties]. 4. Click the [Ports] tab (or the [Details] tab) to confirm the port settings. A USB port is selected if either USBn (Canon MP460) or MPUSBPRNn (Canon MP460) (where n is a number) is indicated. If the port setting is not correct, change the port setting according to the interface you are using on the [Ports] tab (or the [Details] tab), or reinstall the MP driver.
Machine is not properly connected.	Ensure that the USB cable is securely connected to the computer. ● Disconnect the machine and reconnect it directly to the computer and try printing again. If successful, the problem may have been with the device. ● There could also be a problem with the cable(s). Replace the cable(s) and try printing again.
MP driver is not installed properly.	Uninstall then reinstall the MP driver. 1. Click [Start], and select [All Programs] (or [Programs]), the name of your machine, and [Uninstall]. 2. Follow the on-screen instructions to uninstall the driver. 3. Follow the procedures described in the <i>Easy Setup Instructions</i> and reinstall the MP driver.

■ Error No.: 300 Is Displayed

Cause	Action
The machine is not ready.	Ensure that the ON/OFF lamp on the Operation Panel is on. If the lamp on the Operation Panel is off, turn the machine ON. If the Alarm lamp is on, an error may have occurred in the machine. For details on how to resolve the error, refer to "An Error Message Is Displayed On The LCD" on page 98.
Machine is not properly connected.	Ensure that the USB cable is securely connected to the computer. <ul style="list-style-type: none"> ● If using a switching hub or other device, disconnect the machine and reconnect it directly to the computer and try printing again. If successful, the problem may have been with the device. ● There could also be a problem with the cable(s). Replace the cable(s) and try printing again.
Machine you want to use is not selected on the [Printer] pop-up menu on the [Print] dialog box.	Select your machine on the [Printer] pop-up menu on the [Print] dialog box. If your machine does not appear on the [Printer] pop-up menu, add the machine following the procedures described in the <i>Easy Setup Instructions</i> .

■ Error No.: 1700/1710 Is Displayed

Cause	Action
The ink absorber is almost full.	Ink used for cleaning is absorbed in a ink absorber inside the machine. Press [OK] to cancel the error so that you can continue printing. Once the ink absorber becomes completely full, printing cannot be done until the ink absorber is replaced. Canon recommends that you contact a Canon service representative as soon as possible.

■ Error No.: 2001 Is Displayed

Cause	Action
A specified period of time has elapsed without receiving a response from the digital camera. / The digital camera or digital video camcorder connected is not compatible with this machine.	Disconnect the camera cable and reconnect the cable. Depending on the model or brand of your device, you may have to select a print mode compliant with PictBridge before connecting the device. You may also have to turn ON the device or select Play mode manually after connecting the device to the machine. Perform the necessary operations according to the instruction manual supplied with your device. If the error is still unresolved, there is a possibility that you are using a digital camera or digital video camcorder that is not supported by this machine. Use a digital camera or digital video camcorder compatible with this machine.

For Windows Users

Cause	Action
The [Instructions] button is not displayed on the printer driver screen.	The [Instructions] button on the printer driver screen is not displayed if the on-screen manuals (instruction manuals) are not installed. Insert the Setup CD-ROM into your computer and install the on-screen manuals (instruction manuals). The [Instructions] button is displayed only on [Main] and [Maintenance] tabs.
The Scanning Guide cannot be displayed.	The [?] button for displaying the scanner driver operating instruction is grayed out when the on-screen manuals (instruction manuals) are not installed. Insert the Setup CD-ROM into your computer and install the <i>On-screen Manual</i> .

If You Cannot Solve The Problem

If you cannot solve the problem with any of the workarounds in this chapter, please contact the seller of the machine or a Canon service representative.

Canon support staff are trained to be able to provide technical support to satisfy customers.

 **Caution** Attempts by customers to repair or take apart the machine will invalidate any warranty regardless of whether the warranty has expired.

Before contacting a Canon service representative, confirm the following:

- Product name: PIXMA MP460
- Serial number: written on label at rear of machine
- Details of the problem
- What you tried to solve the problem, and what happened

 **Note** If the machine emits any unusual sound, smoke, or odor, turn it OFF immediately. Unplug the power cord from the outlet and contact the seller or a Canon service representative. Never attempt to repair or disassemble the machine yourself.



Chapter 12

Appendix

Printing Area

To ensure the best print quality, the printer has been set to allow for a margin along each edge of the media. However, the actual printable area is the entire area of the media without these margins. By selecting Borderless Printing*, printing with no margins is possible.

* This is available in A4/Letter, 4" x 6" /101.6 x 152.4 mm, 4" x 8" /101.6 x 203.2 mm, and 5" x 7" /127.0 x 177.8 mm and Credit Card paper sizes.

Recommended printing area:	Canon recommends that you print within this area. ()
Printable area:	The area where it is possible to print. However, printing in this area can adversely affect the print quality or the paper feed precision. ()

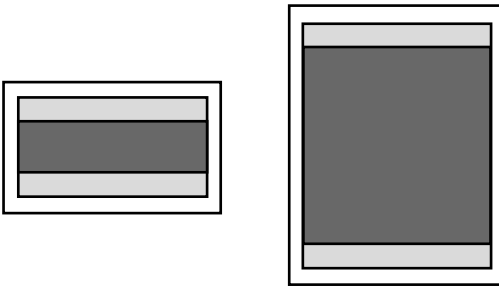

See "A4, B5, A5, 4" x 6", 4" x 8", 5" x 7", Credit Card" on page 122.

See "Letter, Legal" on page 123.

See "Envelopes" on page 123.

■ **A4, B5, A5, 4" x 6", 4" x 8", 5" x 7", Credit Card**

Size	Printable Area (width x height)
A4	203.2 x 289.0 mm/8.0 x 11.4 in
B5	175.2 x 249.0 mm/6.9 x 9.8 in
A5	141.2 x 202.0 mm/5.6 x 7.9 in
4" x 6"/101.6 x 152.4 mm	94.8 x 144.4 mm/3.7 x 5.7 in
4" x 8"/101.6 x 203.2 mm	94.8 x 195.2 mm/3.73 x 7.69 in
5" x 7"/127.0 x 177.8 mm	120.2 x 169.8 mm/4.7 x 6.7 in
Credit Card	47.2 x 78.0 mm/1.86 x 3.07 in

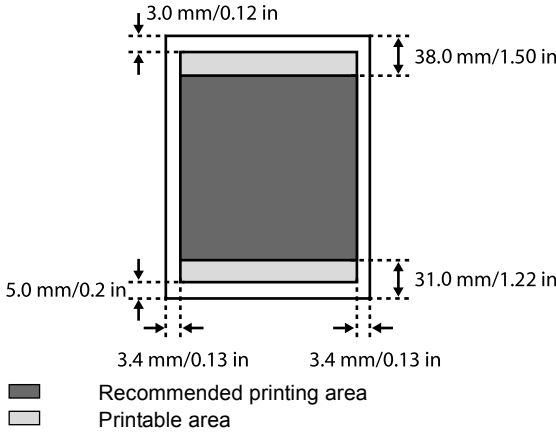

Note

When Printing on Glossy Photo Paper GP-401/GP-501/Matte Photo Paper MP-101/Photo Paper Plus Double Sided PP-101D/Photo Paper Plus Glossy PP-101/Photo Paper Plus Semi-gloss SG-101/SG-201 and Photo Paper Pro PR-101, selection of "Borderless Printing" enables you to make prints with no margins.

However, Borderless Printing may reduce the print quality on the top and bottom edges of the paper or cause smudging on the paper.

■ Letter, Legal

Size	Printable Area (width x height)
Letter	203.2 x 271.4 mm/8.0 x 10.7 in
Legal	203.2 x 347.6 mm/8.0 x 13.7 in

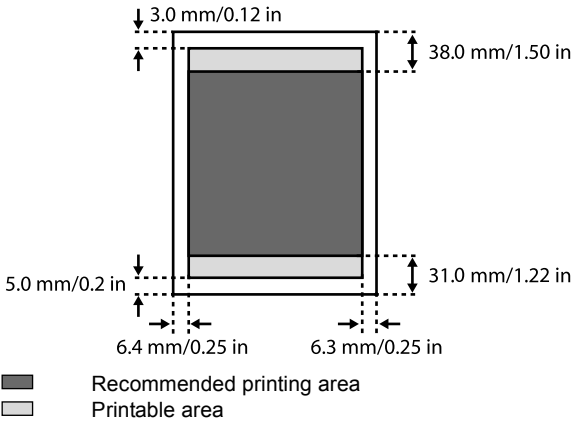

📖 Note

When Printing on Glossy Photo Paper GP-401/GP-501/Matte Photo Paper MP-101/Photo Paper Plus Double Sided PP-101D/Photo Paper Plus Glossy PP-101/Photo Paper Plus Semi-gloss SG-101/SG-201 and Photo Paper Pro PR-101, selection of "Borderless Printing" enables you to make prints with no margins.

However, Borderless Printing may reduce the print quality on the top and bottom edges of the paper or cause smudging on the paper.

■ Envelopes

Size	Printable Area (width x height)
European DL	180.8 x 103.2 mm / 7.12 x 4.06 in
US Com. #10	202.1 x 97.97 mm / 7.96 x 3.86 in

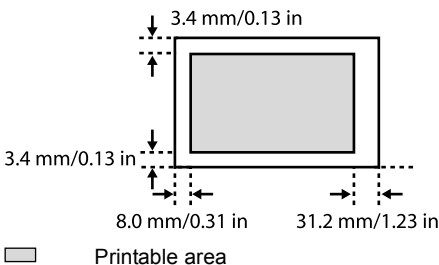

Uninstalling The On-screen Manual

Follow the steps described below to uninstall the installed on-screen manuals from your computer.

Windows

Note that this uninstall procedure will uninstall all guides.

- 1 Click [Start], select [All Programs] (or [Programs]), [Canon MP460 Manual] and [Uninstall].
- 2 When the uninstall message appears, click [OK].
When the message prompting you to restart your computer is displayed, click [OK] to restart your computer.

Macintosh

- **Uninstall the Printer Driver Guide and Scanning Guide.**

Delete the MP driver and scanner driver to uninstall the *Printer Driver Guide* and *Scanning Guide*.

- **Uninstall the User's Guide and Photo Application Guide.**

- 1 Select [Applications] from the [Go] menu.
- 2 Double-click the [Canon Utilities] folder, then [IJ Manual] folder.
- 3 Drag the [MP460] folder into the Trash.
- 4 Drag the [MP460 On-screen Manual] icon on the desktop into the Trash.

Transporting The Machine

When relocating the machine or storing the machine for prolonged periods, pack the machine using the original packing materials.

If you do not have the original packing materials, pack the machine carefully using protective material and a sturdy box.

- 1 Turn the machine OFF and unplug the machine.

 **Important** To protect the machine from damage, do not unplug the machine while the Alarm lamp is on.

- 2 Close the Paper Support and Paper Support Extension.

- 3 Disconnect the USB cable from the computer and from the machine and then disconnect the power cord from the machine.

- 4 To prevent the Scanning Unit or the Paper Support from opening, secure them with tape.

- 5 Cover the machine with protective materials attached on both sides and put it in a box.

 **Note** If using a transport company, clearly label the box as fragile.

Specifications

General Specifications	
Printing resolution	4800 dpi x 1200 dpi (Ink droplets can be positioned at a minimum pitch of 1/4800 inch.)
Print speed* *Based on Canon standard pattern. Print speed may vary depending on system configuration, software, document complexity, print mode and page coverage.	Black printing (text pattern) Max Speed (Custom Setting 5): 22 ppm Standard: 13.4 ppm Color printing Max Speed (Custom Setting 5): 17 ppm Standard: 7.8 ppm
Print width	203.2 mm max. (8.0 in) (for Borderless Printing: 216.0 mm/8.5 in)
Resident print control mode	Canon extended mode
Receive buffer	43 KB
Interface	USB 2.0 Hi-Speed / Direct Print Port / IrDA / Bluetooth1.2 (Option)
Acoustic noise level	Approx. 45 dB (A) (when printing in the highest print quality mode on Photo Paper Pro)
Operating environment	Temperature: 5 to 35°C (41 to 95°F) Humidity: 10 to 90%RH (no condensation)
Storage environment	Temperature: 0 to 40°C (32 to 104°F) Humidity: 5 to 95% RH (no condensation)
Power supply	AC 100-240 V, 50/60 Hz
Power consumption	Standby (minimum): Approx. 2 W Printing (Copy): Approx. 13 W OFF: Approx. 0.7 W
Dimensions (with Paper Support retracted)	443 (W) x 417 (D) x 185 (H) mm 17.44 (W) x 16.42 (D) x 7.28 (H) in
Weight	Approx. 7.1 kg (15.7 lb)
Ink Cartridges	Standard Canon FINE Cartridges Black: Canon FINE Cartridge PG-40 Color: Canon FINE Cartridge CL-41 High Yield Canon FINE Cartridges (Option) Black: Canon FINE Cartridge PG-50 Color: Canon FINE Cartridge CL-51 Nozzles Black: 320 nozzles (600 dpi) Cyan, Magenta, Yellow: 384 x 3 nozzles (600 dpi)

Copy Specifications

Copy speed* *Based on Canon standard pattern. Copy speed may vary depending on document complexity, copy mode, page coverage and the number of copies.	Black & white: <Fast> mode approx. 22 ppm (Letter size) Color: <Fast> mode approx. 17 ppm (Letter size)
No. of copies	Maximum 99 copies
Density adjustment	9 levels
Zoom	25% to 400%

Camera Direct Print (PictBridge)

Page size	Default (Photo Paper Plus Glossy 10 x 15 cm/4" x 6") 10 x 15 cm/4" x 6" (Photo Paper Plus Glossy, Photo Paper Pro, Photo Paper Plus Semi-gloss, Glossy Photo Paper, Photo Stickers ^{*1}) 13 x 18 cm/5" x 7" (Photo Paper Plus Glossy) ^{*2} A4/8.5" x 11" (Photo Paper Plus Glossy A4/Letter, Photo Paper Pro A4/Letter, Photo Paper Plus Semi-gloss A4/Letter, Glossy Photo Paper A4/Letter, Plain Paper A4/Letter) 5.4 x 8.6 cm/Credit Card (Glossy Photo Paper Card Size) ^{*1} Canon-brand sticker. Printing on this paper is available only when the Layout function on your camera has a 16-up option. See "Recommended Paper" on page 17. ^{*2} If using a Canon PictBridge-compatible camera, you can select it.
Media type	Default (Photo Paper Plus Glossy), Photo (Photo Paper Plus, Photo Paper Plus Semi-gloss, Glossy Photo Paper, Photo Stickers), Fast Photo (Photo Paper Pro), Plain Paper (Only A4/Letter)
Layout	Default (Borderless), Borderless, Bordered, N-up (2, 4, 9, 16)* * Layout compatible with Canon-brand sticker above. See "Recommended Paper" on page 17.
Trimming	Default (Off: No trimming), On (follow camera's setting), Off
Enhance image	Default (ExifPrint), On, Off, "VIVID" ^{**} , "NR" (Noise Reduction) [*] , "VIVID+NR" ^{**} , "FACE" ^{**} [*] If using a Canon PictBridge-compatible camera, you can select it.

Scan Specifications

Compatibility	TWAIN / WIA (Windows XP)
Effective scanning width	216 mm / 8.5 inches
Scanning resolution	Optical resolution: 1200 dpi x 2400 dpi optical Interpolated resolution: 19200 dpi x 19200 dpi enhanced
Gradation (Input / Output)	Gray: 16 bit / 8 bit Color: 48 bit / 24 bit (RGB each 16 bit / 8 bit)

Systems Requirements

Windows

- Use a computer on which Windows XP, Windows 2000, Windows Me or Windows 98 can operate.
(Pentium®, Celeron® 566MHz / 128MB RAM: 256MB recommended)
- USB 2.0 Hi-Speed interface
USB 2.0 Hi-Speed¹ operation can only be guaranteed under the environments below.
OS: Windows XP (SP1 or later)/Windows 2000 (SP4 or later)
USB 2.0 Hi-Speed driver: USB 2.0 driver for Windows²
USB 2.0 Hi-Speed interface: a PC and a USB cable that comply with USB 2.0 Hi-Speed standard³
¹ Since the USB 2.0 Hi-Speed interface is fully upwardly compatible with USB Full-Speed (USB 1.1), it can be used at USB Full-Speed (USB 1.1).
² Microsoft's authorized drivers are available through Windows Update or Service Pack installation. Any non-Microsoft USB 2.0 drivers are not guaranteed.
³ All operations are not guaranteed for computers standard-equipped with a USB 2.0 Hi-Speed interface.
- USB interface
USB operation can only be guaranteed on a PC with preinstalled Windows XP, Windows 2000, Windows Me, or Windows 98 or a PC preinstalled with Windows 98 or later and upgraded to Windows XP, Windows 2000, or Windows Me.
- The CD-ROM drive, or the CD-ROM drive that is shared online.
- Available hard-disk space for printer driver installation.
Windows XP/Windows 2000/Windows Me/Windows 98: Approx. 550 MB
- Canon IJ Status Monitor cannot be used under the following conditions:
 - When sharing this machine on a network (Windows Me, Windows 98)

Macintosh

- Use a Macintosh series computer equipped with USB interface on which Mac OS X v.10.2.8 or later can operate.
- USB 2.0 Hi-Speed interface
USB 2.0 Hi-Speed^{*} operation can only be guaranteed under the environments below.
OS: Mac OS X v.10.2.8 or later
An internal USB 2.0 Hi-Speed port and a USB cable that comply with the USB 2.0 Hi-Speed standard (USB 2.0 Hi-Speed operation on the expansion board is not guaranteed.)
^{*} Since the USB 2.0 Hi-Speed interface is fully upwardly compatible with USB Full-Speed (USB 1.1), it can be used at USB Full-Speed (USB 1.1).
- USB interface
- CD-ROM drive
- Available hard-disk space for printer driver installation.
Mac OS X v.10.2.8 or later: Approx. 450 MB
- The following functions are not supported:
 - Duplex Printing
 - Photo Optimizer PRO
 - Poster Printing
 - Fit-to-Page Printing
 - Booklet Printing
 - Reverse Order Printing (supported with Mac OS X v.10.3.x or later)

Additional Systems Requirements for On-screen Manuals

Windows

Browser: Windows HTML Help Viewer

Note

Microsoft Internet Explorer 5.0 or later must be installed.

The on-screen manuals may not be displayed properly depending on your operating system or Internet Explorer version. We recommend that you keep your system up to date with Windows Update.

Macintosh

Browser: Help Viewer

Note

The on-screen manuals may not be displayed properly depending on your operating system. We recommend that you keep your system up to date.

Regulatory Information

FCC Notice (U.S.A. Only)

For 120V, 60Hz model

Model Number: K10283

This device complies with Part 15 of the FCC Rules. Operation is subject to the following two conditions:

- (1) This device may not cause harmful interference, and
- (2) This device must accept any interference received, including interference that may cause undesired operation.

This equipment has been tested and found to comply with the limits for a class B digital device, pursuant to Part 15 of the FCC Rules. These limits are designed to provide reasonable protection against harmful interference in a residential installation. This equipment generates, uses and can radiate radio frequency energy and, if not installed and used in accordance with the instructions, may cause harmful interference to radio communications. However, there is no guarantee that interference will not occur in a particular installation. If this equipment does cause harmful interference to radio or television reception, which can be determined by turning the equipment off and on, the user is encouraged to try to correct the interference by one or more of the following measures:

- Reorient or relocate the receiving antenna.
- Increase the separation between the equipment and receiver.
- Connect the equipment into an outlet on a circuit different from that to which the receiver is connected.
- Consult the dealer or an experienced radio/TV technician for help.

Use of shielded cable is required to comply with class B limits in Subpart B of Part 15 of the FCC Rules.



Warning

Do not make any changes or modifications to the equipment unless otherwise specified in this guide. If such changes or modifications should be made, you could be required to stop operation of the equipment.

Canon U.S.A., Inc.
One Canon Plaza, Lake Success, NY 11042, U.S.A.
TEL No. 1-516-328-5600

Canon U.S.A., INC. LIMITED WARRANTY (USA Only)

The limited warranty set forth below is given by Canon U.S.A., Inc. ("Canon USA") with respect to the new or refurbished Canon-brand product ("Product") packaged with this limited warranty, when purchased and used in the United States only.

The Product is warranted against defects in materials and workmanship under normal use and service (a) for a period of one (1) year from the date of original purchase when delivered to you in new condition in its original container or (b) for 90 days from the date of original purchase for refurbished Products. Defective parts or a defective Product returned to a Canon USA repair facility or a Canon USA Authorized Service Facility ("ASF"), and proven to be defective upon inspection will be (a) repaired; (b) exchanged for new or comparable rebuilt, recovered, remanufactured, repaired and/or recycled parts or; (c) exchanged for a refurbished Product, as determined by the Canon USA repair facility or the ASF. Warranty repair or replacement shall not extend the original warranty period of the Product. A dated proof of purchase is required at the time of warranty service. A copy of your dated bill of sale will satisfy this requirement. This warranty does not cover any accessories, or any consumables, such as paper or ink cartridges, as to which there shall be no warranty or replacement.

This limited warranty shall only apply if the Product is used in conjunction with compatible computers, peripheral equipment and software. Canon USA shall have no responsibility for such items except for compatible Canon brand peripheral equipment covered by a separate warranty ("Separate Warranty"). Repairs of such Canon brand peripheral equipment shall be governed by the terms of the Separate Warranty. Non-Canon brand equipment and software that may be distributed with the Product are sold "as is" and without warranty of any kind by Canon USA, including any implied warranty regarding merchantability or fitness for a particular purpose, and all such warranties are disclaimed. The sole warranty, if any, with respect to such non-Canon brand items is given by the manufacturer or producer thereof.

This limited warranty covers all defects encountered in normal use of the Product and does not apply in the following cases:

- (a) Loss of or damage to the Product due to abuse, neglect, mishandling, improper packaging by you, alteration, accident, electrical current fluctuations, improper use, failure to follow operating or maintenance instructions in, or environmental conditions prescribed in, Canon USA's user's manual or other documentation, or services performed by someone other than a Canon USA repair facility or ASF. Without limiting the foregoing, dropping the Product, scratches, and abrasions will be presumed to have resulted from misuse, abuse or failure to operate the Product as set forth in the user's manual or other documentation for the Product.
- (b) Use of parts, media, software or supplies (other than those sold by Canon USA), including non-Canon ink cartridges or refilled ink cartridges, that cause damage to the Product or cause abnormally frequent service calls or service problems.
- (c) If the Product has had its serial number or dating defaced, altered or removed.

ANY SYSTEM SOFTWARE (WHETHER FACTORY LOADED ON THE PRODUCT OR CONTAINED ON THE SOFTWARE DISKETTES OR CD-ROMS ENCLOSED WITH, OR ACCOMPANYING, THE PRODUCT), AND ANY UTILITY SOFTWARE, DISTRIBUTED WITH OR FOR THE PRODUCT, IS SOLD "AS IS" AND WITHOUT WARRANTY BY CANON USA. THE SOLE WARRANTY WITH RESPECT TO SUCH SOFTWARE IS CONTAINED IN THE SOFTWARE MANUFACTURER'S LICENSE AGREEMENT DISTRIBUTED THEREWITH, INCLUDING ANY LIMITATIONS AND DISCLAIMERS THEREON. PLEASE CONTACT CANON USA IMMEDIATELY IF YOU HAVE NOT RECEIVED A COPY OF THE SOFTWARE MANUFACTURER'S LICENSE AGREEMENT.

NO IMPLIED WARRANTY, INCLUDING ANY IMPLIED WARRANTY OF MERCHANTABILITY OR FITNESS FOR A PARTICULAR PURPOSE, APPLIES TO THE PRODUCT AFTER THE APPLICABLE PERIOD OF THE EXPRESS LIMITED WARRANTY STATED ABOVE, AND NO OTHER EXPRESS WARRANTY OR GUARANTY, EXCEPT AS MENTIONED ABOVE, GIVEN BY ANY PERSON OR ENTITY WITH RESPECT TO THE PRODUCT SHALL BIND CANON USA, OR ITS ASF. (SOME STATES DO NOT ALLOW LIMITATIONS ON HOW LONG AN IMPLIED WARRANTY LASTS, SO THE ABOVE LIMITATION MAY NOT APPLY TO YOU.) CANON USA SHALL NOT BE LIABLE FOR LOSS OF REVENUES OR PROFITS, INCONVENIENCE, EXPENSE FOR SUBSTITUTE EQUIPMENT OR SERVICE, STORAGE CHARGES, LOSS OR CORRUPTION OF DATA, OR ANY OTHER SPECIAL, INCIDENTAL OR CONSEQUENTIAL DAMAGES CAUSED BY THE USE, MISUSE, OR INABILITY TO USE THE PRODUCT REGARDLESS OF THE LEGAL THEORY ON WHICH THE CLAIM IS BASED, AND EVEN IF CANON USA OR ITS ASF HAS BEEN ADVISED OF THE POSSIBILITY OF SUCH DAMAGES. NOR SHALL RECOVERY OF ANY KIND AGAINST CANON USA OR ITS ASF BE GREATER IN AMOUNT THAN THE PURCHASE PRICE OF THE PRODUCT CAUSING THE ALLEGED DAMAGE. WITHOUT LIMITING THE FOREGOING, YOU ASSUME ALL RISK AND LIABILITY FOR LOSS, DAMAGE OR INJURY TO YOU AND YOUR PROPERTY AND TO OTHERS AND THEIR PROPERTY ARISING OUT OF THE POSSESSION, USE, MISUSE, OR INABILITY TO USE THE PRODUCT SOLD BY CANON USA NOT CAUSED SOLELY AND DIRECTLY BY THE NEGLIGENCE OF CANON USA, OR ITS ASF. (SOME STATES DO NOT ALLOW THE EXCLUSION OR LIMITATION OF INCIDENTAL OR CONSEQUENTIAL DAMAGES, SO THE ABOVE EXCLUSION OR LIMITATION MAY NOT APPLY TO YOU.) THIS LIMITED WARRANTY SHALL NOT EXTEND TO ANYONE OTHER THAN THE ORIGINAL PURCHASER OF THE PRODUCT OR THE PERSON FOR WHOM IT WAS PURCHASED AS A GIFT, AND STATES YOUR EXCLUSIVE REMEDY.

Canon USA offers a range of customer technical support* options:

- Interactive troubleshooting, e-mail technical support, the latest driver downloads and answers to frequently asked questions (www.canontechsupport.com)
- Toll-free live technical support Monday-Saturday (excluding holidays) at 1-800-828-4040
- Telephone Device for the Deaf (TDD-1-866-251-3752)
- Repair or Exchange Service Options:
In the event service is required for the Product during the limited warranty period, Canon USA offers two hardware support options:

Authorized Service Facility Carry-In / Mail-In Service

Canon USA's Carry-In/Mail-In Service provides repair or exchange, at Canon USA's option, through Canon USA's Authorized Service Facility (ASF) network. The name and telephone number of the ASF(s) near you may be obtained from Canon USA's Web site at www.canontechsupport.com or by calling the Canon USA Customer Care Center at 1-800-828-4040, or any time while speaking to a technical support person. A Product covered by this limited warranty will be repaired or exchanged, as determined by Canon USA, and returned without charge by the ASF.

InstantExchange Service **

A Canon Customer Care Center or ASF technician will attempt to diagnose the nature of the problem and, if possible, correct it over the telephone. If the problem cannot be corrected over the telephone, and you elect the InstantExchange option, a reference number will be issued to you. You will be asked for the Product serial number and other information pertaining to your defective Product and for a ship-to location for the replacement Product (must include street address).

The Canon USA repair facility will ship out the replacement Product, via 2nd day Air freight service, prepaid by Canon USA. After receipt of the replacement Product (with instructions and a prepaid waybill), follow the enclosed instructions on how to ship the defective Product to the Canon USA repair facility. The defective Product must be returned in the shipping carton in which the replacement Product was packed and include the reference number, A COPY OF YOUR DATED PROOF OF PURCHASE (BILL OF SALE), and a complete explanation of the problem. DO NOT INCLUDE ANY OTHER ITEMS WITH THE DEFECTIVE PRODUCT IN THE RETURN SHIPPING CARTON, AND BE SURE TO RETAIN YOUR PRINTHEAD AND INK CARTRIDGE(S) AND TANK(S).

InstantExchange Service expedites, usually by the second business day, the exchange of a defective Product with a replacement Product, which will normally be shipped the same day if your request for this service is by 3 p.m. E.T. Monday through Friday, except holidays (three (3) business day InstantExchange Service for Alaska and Hawaii). Canon USA does not guarantee expedited shipping service in the event of the occurrence of factors beyond its reasonable control.

The replacement Product you receive may be a refurbished or reconditioned unit and will be covered for the balance of the period remaining on your original limited warranty. NOTE THAT BY USING THIS SERVICE YOU WILL KEEP THE REPLACEMENT PRODUCT THAT IS SENT TO YOU. CANON USA WILL RETAIN THE DEFECTIVE PRODUCT THAT YOU ORIGINALLY PURCHASED, WHICH SHALL BECOME THE PROPERTY OF CANON USA. InstantExchange warranty program service is available only during the express limited-warranty period for your Product and only in the continental United States, Alaska and Hawaii during such period.

This limited warranty gives you specific legal rights, and you may also have other rights, which vary from state to state.

* Support program specifics are subject to change without notice.

** InstantExchange warranty service is subject to the availability of refurbished or new replacement units.

**Canon U.S.A., Inc.
One Canon Plaza
Lake Success, NY 11042
USA**

Canon is a registered trademark of Canon Inc.

Users In Canada

Caution

- This Class B digital apparatus meets all requirements of the Canadian Interference-Causing Equipment Regulations.
- Cet appareil numérique de la classe B respecte toutes les exigences du Règlement sur le matériel brouilleur du Canada.

Customer Technical Supports

Canon Canada Inc., offers a full range of customer technical support* options:

- For interactive troubleshooting, e-mail technical support, the latest driver downloads and answers to frequently asked questions (www.canon.ca)
- Automated interactive telephone support on most current products 24 hours, 7 days a week (1-800-OK-CANON)
- Free live technical support Mon - Fri 9am-8pm EST (excluding holidays) for products still under warranty (1-800-OK-CANON)
- The location of the authorized service facility nearest you (1-800-OK-CANON) If the problem cannot be corrected by using one of the above technical support options, repair options are available at the time of your call to the Free live technical support number above or via the website at www.canon.ca

* Support program specifics are subject to change without notice.

CANON CANADA INC.

1-800-OK-CANON (1-800-652-2666)

24 HOURS A DAY, SEVEN DAYS A WEEK

<http://www.canon.ca>

Index

▲▼◀▶ Buttons 12

A

Access Lamp 11
Alarm Lamp 12
Auto Sheet Feeder 10

B

Back Button 12
Black Button 12

C

Card Slot Cover 10
Card Slots 11
Changing Copy Settings 33
Changing The Print Settings 26
 Copy mode 28
 Memory card mode 29
Cleaning 93
 Bottom Plate 95
 Exterior 93
 Platen Glass And Document Cover 93
 Protrusions Inside The Machine 96
 Roller 94
Color Button 12
COPY Button 13
Copying 31

D

Device Settings 71
 Bluetooth Settings 73
 Language Selection 74
 Load Settings 74
 Other Settings 73
 Print Settings 72
 Reset Setting 74
 Save Settings 74
 Wireless Print Settings 72
Direct Print Port 10
Document Cover 10

F

FINE Cartridge Holder 11
FINE Cartridges 11
 CL-41 Color (Standard) 75
 CL-51 Color (High Yield) 75
 Low Ink Warning 81
 PG-40 Black (Standard) 75
 PG-50 Black (High Yield) 75
 Replacing A FINE Cartridge 75
 When To Replace A FINE Cartridge 79

G

General Paper Guidelines 16

I

IrDA Port 10

L

LCD (Liquid Crystal Display) 12
Loading Paper 23
 Loading Envelopes 24

M

Machine Parts 10
Memory Card 37
 Inserting 38
 Reading From/Writing To 50
 Removing 39
 Write Protection 50
MEMORY CARD Button 12
Menu Button 12

N

Nozzle Check Pattern 85
 Examining 87
 Printing 86

O

OK Button 12
ON/OFF Button 12
Operation Panel 12

P

Paper Guide 10
Paper Output Tray 10
Paper Support 10
Paper Support Extension 10
Paper Thickness Lever 11
Photo Index Sheet Button 13
Platen Glass 10
Power Connector 11
Printing Becomes Faint Or Color Is Incorrect 84
Printing From Your Computer 52
 Printing With Macintosh 55
 Printing With Windows 52
Printing Photographs From A Digital Camera 61
 From A PictBridge-Compliant Device 61
Printing Photographs From A Memory Card 37
 Multi-photo Print 41
 Other Useful Functions 46
 Photo Index Sheet 42
 Single-photo Print 40
Printing Photographs From A Wireless
 Communication Device 65
 Bluetooth Communication 69
 Infrared Communication 67
 Wireless Print Settings 65

R

- Recommended Paper 17
- Regulatory Information 129
- Routine Maintenance 75
 - Aligning The FINE Cartridge 91
 - FINE Cartridge Cleaning 89
 - FINE Cartridge Deep Cleaning 90
 - Replacing A FINE Cartridge 75

S

- Safety Precautions 4
- SCAN Button 12
- Scanning Images 58
 - From An Application Software 60
 - Using The MP Navigator 58
 - Using The SCAN Button 59
- Scanning Unit 11
- Scanning Unit Support 11
- Setting Documents 15
 - Document Requirements 15
 - Loading Documents 15
- Settings Button 12
- Specifications 126
- Stop/Reset Button 12

T

- Troubleshooting 97
 - Paper Jams 106

U

- USB Port 11
- Useful Copy Functions 34
 - Borderless Copy 35
 - Image Repeat 36
 - Sticker Copy 34
- Users In Canada 133

This product uses the following copyrighted software:

exit.c Copyright © 1990 The Regents of the University of California.
All rights reserved.

Redistribution and use in source and binary forms are permitted provided that the above copyright notice and this paragraph are duplicated in all such forms and that any documentation, advertising materials, and other materials related to such distribution and use acknowledge that the software was developed by the University of California, Berkeley. The name of the University may not be used to endorse or promote products derived from this software without specific prior written permission.

THIS SOFTWARE IS PROVIDED "AS IS" AND WITHOUT ANY EXPRESS OR IMPLIED WARRANTIES, INCLUDING, WITHOUT LIMITATION, THE IMPLIED WARRANTIES OF MERCHANTABILITY AND FITNESS FOR A PARTICULAR PURPOSE.

environ.c Copyright © 1995, 1996 Cygnus Support.
All rights reserved.

Redistribution and use in source and binary forms are permitted provided that the above copyright notice and this paragraph are duplicated in all such forms and that any documentation, advertising materials, and other materials related to such distribution and use acknowledge that the software was developed at Cygnus Support, Inc. Cygnus Support, Inc. may not be used to endorse or promote products derived from this software without specific prior written permission.

THIS SOFTWARE IS PROVIDED "AS IS" AND WITHOUT ANY EXPRESS OR IMPLIED WARRANTIES, INCLUDING, WITHOUT LIMITATION, THE IMPLIED WARRANTIES OF MERCHANTABILITY AND FITNESS FOR A PARTICULAR PURPOSE.

impure.c Copyright © 1994, 1997 Cygnus Solutions.
string.h All rights reserved.
_ansi.h

Redistribution and use in source and binary forms are permitted provided that the above copyright notice and this paragraph are duplicated in all such forms and that any documentation, advertising materials, and other materials related to such distribution and use acknowledge that the software was developed at Cygnus Solutions. Cygnus Solutions may not be used to endorse or promote products derived from this software without specific prior written permission.

THIS SOFTWARE IS PROVIDED "AS IS" AND WITHOUT ANY EXPRESS OR IMPLIED WARRANTIES, INCLUDING, WITHOUT LIMITATION, THE IMPLIED WARRANTIES OF MERCHANTABILITY AND FITNESS FOR A PARTICULAR PURPOSE.

Ordering Information

For additional supplies, use the following descriptions and order numbers.

Description	Order #
FINE Cartridges	
PG-40 Black	0615B002
CL-41 Color	0617B002
PG-50 Black High Yield	0616B002
CL-51 Color High Yield	0618B002
Canon Specialty Papers	
Photo Paper Plus Glossy (4" x 6"/20 sheets)	7980A007
Photo Paper Plus Glossy (4" x 6"/50 sheets)	7980A012
Photo Paper Plus Glossy (4" x 6"/120 sheets)	7980A022
Photo Paper Plus Glossy (5" x 7"/20 sheets)	7980A019
Photo Paper Plus Glossy (8.5" x 11"/20 sheets)	7980A006
Photo Paper Plus Double Sided (5" x 7"/10 sheets)	9981A006
Photo Paper Plus Double Sided (8.5" x 11"/10 sheets)	9981A005
Photo Paper Plus Double Sided Album Kit (5" x 7")	0041B005
Photo Paper Plus Double Sided Album Kit (8.5" x 11")	0041B006
Photo Paper Plus Semi-Gloss (4" x 6"/50 sheets)	8386A010
Photo Paper Plus Semi-Gloss (8.5" x 11"/20 sheets)	8386A007
Photo Paper Pro for Borderless Printing (4" x 6"/20 sheets)	1029A014
Photo Paper Pro for Borderless Printing (4" x 6"/75 sheets)	1029A027
Photo Paper Pro All Occasion Photo Cards (4" x 8"/50 sheets)	1029A055
Photo Paper Pro (8.5" x 11"/15 sheets)	1029A004
Photo Paper Pro (8.5" x 11"/30 sheets)	1029A028
Matte Photo Paper (8.5" x 11"/50 sheets)	7981A004
Photo Paper Glossy (4" x 6"/50 sheets)	0755B021
Photo Paper Glossy (4" x 6"/100 sheets)	0775B022
Photo Paper Glossy (8.5" x 11"/50 sheets)	0775B023
Photo Paper Glossy (8.5" x 11"/100 sheets)	0775B024
Glossy Photo Paper Credit Card Size	9157A023
Photo Stickers	0001C001
Transparencies (8.5" x 11"/50 sheets)	1043A004
High Resolution Paper (8.5" x 11"/100 sheets)	1033A011

Call 1-800-OK-CANON to locate a dealer near you, or visit the Canon eStore at www.estimate.usa.canon.com.



© 2006 Canon U.S.A., Inc. Canon is a registered trademark of Canon Inc. in the United States and may be a registered trademark or trademarks in other countries. All other product and brand names are trademarks of their respective owners. As an ENERGY STAR® partner, Canon U.S.A., Inc. has determined that this product meets the ENERGY STAR® guidelines for energy efficiency.

The following FINE Cartridges (Standard) are compatible with this machine.



The following FINE Cartridges (High Yield) are also compatible with this machine.

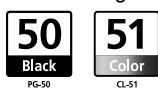

For details on FINE Cartridge replacement, refer to "Replacing A FINE Cartridge" in this guide.

Free Manuals Download Website

<http://myh66.com>

<http://usermanuals.us>

<http://www.somanuals.com>

<http://www.4manuals.cc>

<http://www.manual-lib.com>

<http://www.404manual.com>

<http://www.luxmanual.com>

<http://aubethermostatmanual.com>

Golf course search by state

<http://golfingnear.com>

Email search by domain

<http://emailbydomain.com>

Auto manuals search

<http://auto.somanuals.com>

TV manuals search

<http://tv.somanuals.com>