



Impressa Z5

Fully Automatic
Coffee & Espresso Center
with Clearyl Water Care System

Operating Instructions
and Warranty

Customer Service 1-800-220-5701

65349R

IMPORTANT SAFEGUARDS

When using electrical appliances, basic safety precautions should always be followed, including the following:

1. Read all instructions.
2. Do not touch hot surfaces. Use handles or knobs.
3. To protect against fire, electric shock and personal injury, do not immerse cord, plugs or appliance in water or other liquids.
4. Close supervision is necessary when any appliance is used by or near children.
5. Unplug from outlet when not in use and before cleaning. Allow it to cool before putting on or taking off parts, and before cleaning the appliance.
6. Do not operate any appliance with a damaged cord or plug or after the appliance malfunctions, or has been damaged in any manner. Return appliance to the nearest authorized service facility for examination, repair or adjustment.
7. The use of accessory attachments not recommended by the appliance manufacturer may result in fire, electric shock, or personal injury.
8. Do not use outdoors.
9. Do not let the cord hang over the edge of a table or counter, or touch hot surfaces.
10. Do not place on or near a hot gas or electric burner, or in a heated oven.
11. Always attach plug to appliance first, then plug cord into

wall outlet. To disconnect, turn any control to "off" then remove plug from wall outlet.

12. Do not use appliance for other than intended use.
13. Use extreme caution when disposing hot steam.
14. For household use only.

SAVE THESE INSTRUCTIONS SPECIAL CORD SET INSTRUCTIONS

Regarding your cord set:

- A. A short power-supply cord (or detachable power-supply cord) is to be provided to reduce risks resulting from becoming entangled in or tripping over a longer cord.
- B. Longer detachable power-supply or extension cords are available and may be used if care is exercised in their use.
- C. If a long detachable power-supply cord or extension cord is used,
 - 1) The marked electrical rating of the detachable power-supply cord or extension cord should be at least as great as the electrical rating of the appliance,
 - 2) If the appliance is of the grounded type, the extension cord should be a rounding type 3-wire cord, and
 - 3) The longer cord should be arranged so that it will not drape over the counter-top or table-top where it can be pulled on by children or tripped over.

2.

Notice: Your Impressa Z5 has a 3-prong grounded plug. To reduce the risk of electrical shock this plug will fit in an outlet only one way. If the plug does not fit in the outlet contact a qualified electrician. DO NOT modify the plug in any way.

CAUTION

This appliance is for household and commercial use. Any servicing other than cleaning and user maintenance should be performed by an authorized service representative.

- Do not immerse base in water or try to disassemble.
- To reduce the risk of fire or electric shock, do not remove the base. No user serviceable parts inside. Repair should be done by authorized service personnel only.
- Check voltage to be sure that the voltage indicated on the name plate agrees with your voltage.
- Never use warm or hot water to fill the water container! Use cold water only!
- Keep your hands and the cord away from hot parts of the appliance during operation.
- Never clean with scouring powders or hard implements.

JURA-CAPRESSO

Jura was founded in 1931 in Switzerland. Capresso was founded in 1994 in the USA. Both companies have joined forces in the US to bring you the finest Fully Automatic Coffee Centers available anywhere. With innovative and user-friendly features, high quality materials, clear instructions and superb customer service, we are sure you will experience the best coffee, espresso, cappuccino or latte you have ever had. We hope you will enjoy your new Fully Automatic Coffee Center and will recommend it to your friends. For more information about our products visit our website www.capresso.com.

Michael Kramm, President

Customer Service

1-800-220-5701

Mon-Thu 9AM – 9PM • Fri 9AM – 8PM • Sat 9AM – 5PM
Eastern Standard Time.
email: contact@capresso.com

Jura-Capresso LLC.

81 Ruckman Road, Closter, NJ 07624

201-767-3999 • Fax: 201-767-9684

Website: www.capresso.com

3.

Fig. 1

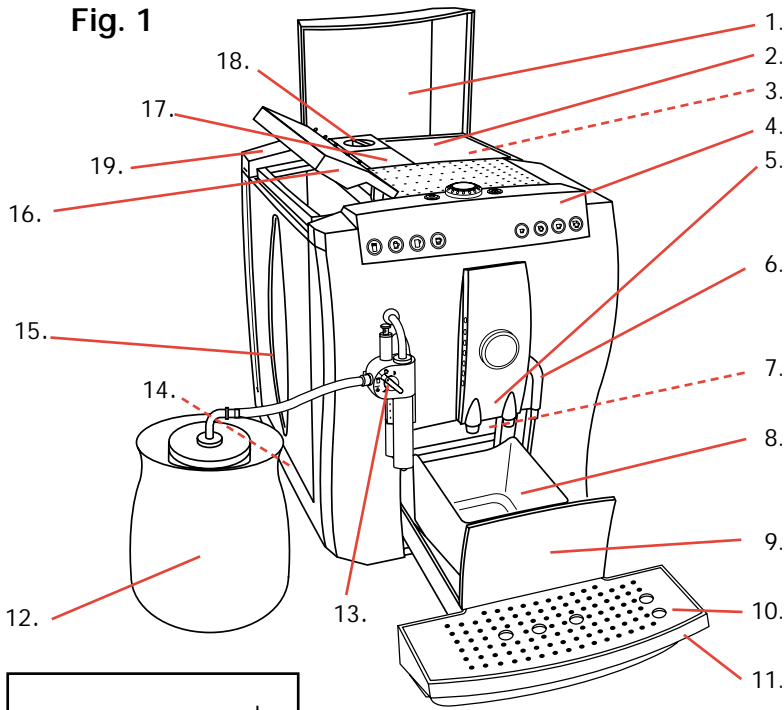

1. Cover lid (spring loaded)
2. Bean container safety lid (Fig. 4)
3. Bean container
4. Operating panel (Fig. 3)
5. Dual coffee spout (adjustable height)
6. Hot water spout
7. Cup illumination (behind coffee spouts)
8. Used coffee container
9. Removable tray
10. Stainless steel grid
11. Removable drawer
12. Thermal milk container
13. Auto cappuccino system
14. Main power switch (Fig. 3a)
15. Water tank
16. Water tank lid
17. Lid for ground coffee (Fig. 4)
18. Grind fineness selector (Fig. 4)
19. Lid for service connector

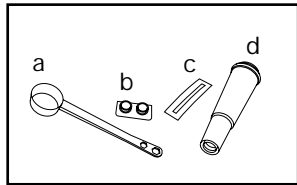

- a. Measuring scoop
- b. Cleaning tablets
- c. Water hardness indicator strip
- d. Clearyl Water cartridge* (unpacked)

Fig. 2

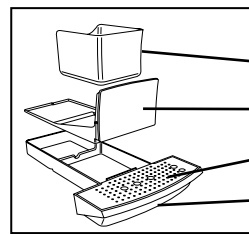

8. Used Coffee Container
9. Tray
10. Grid
11. Drawer

* Attention: The Water Filter Cartridge should be in a pouch.
If your machine comes with the cartridge installed, it is not a new machine!
Call customer service 1-800-220-5701.

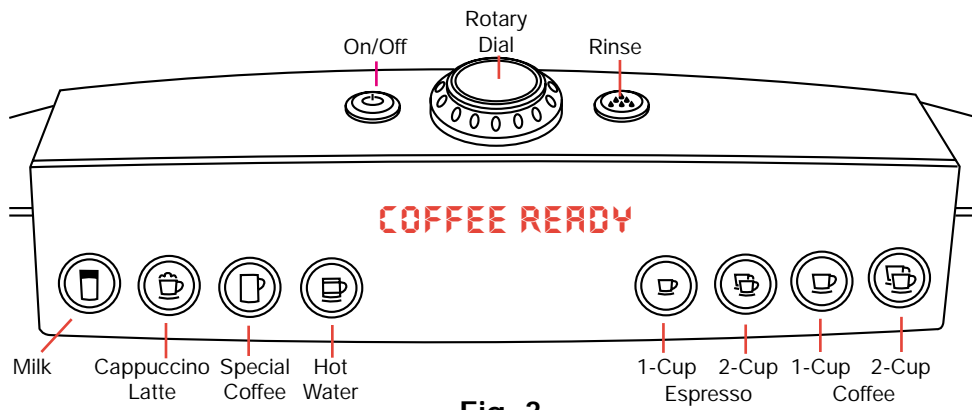

Fig. 3

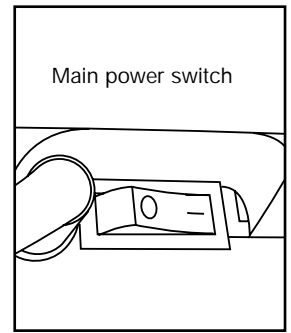

Fig. 3a

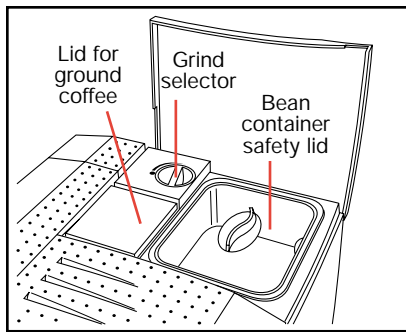

Fig. 4

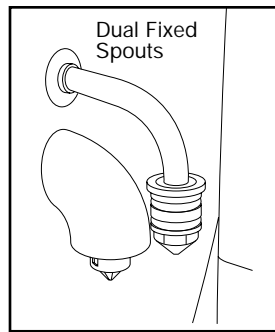

Fig. 5

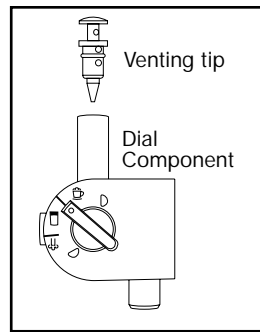

Fig. 5a

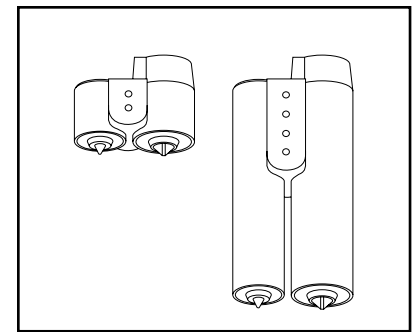

Fig. 5b

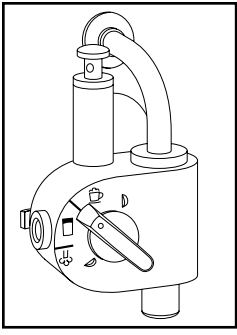

Fig. 5c

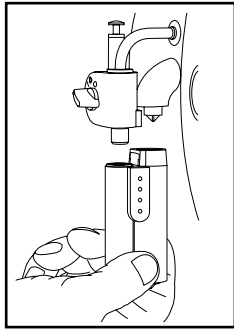

Fig. 5d

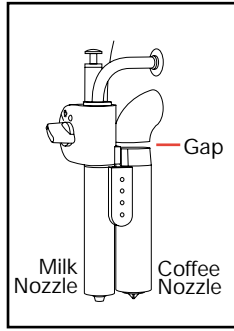

Fig. 5e

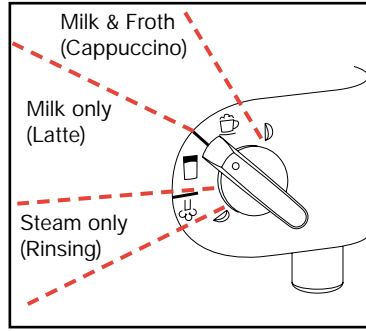

Fig. 5f

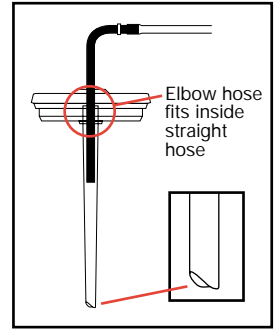

Fig. 6

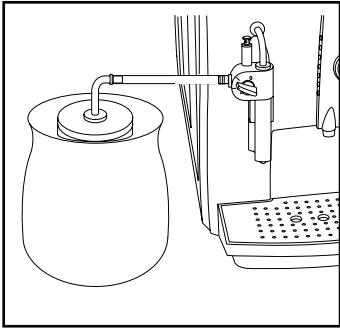

Fig. 6a

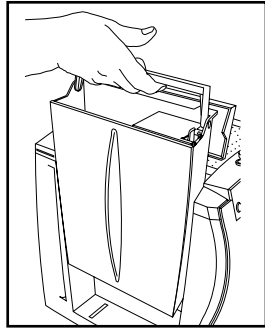

Fig. 7

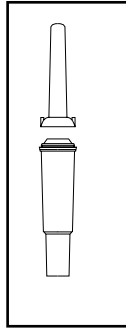

Fig. 8

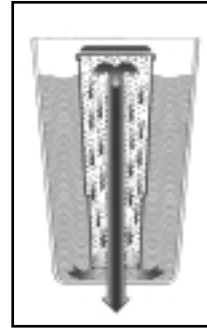

Fig. 9

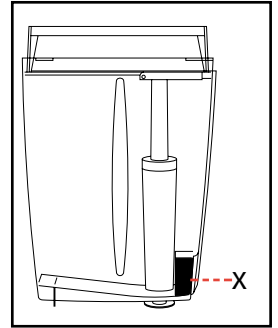

Fig. 10

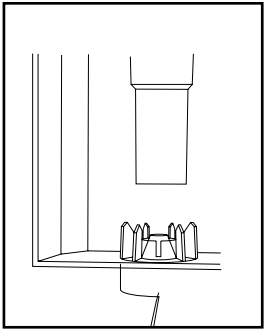

Fig. 11

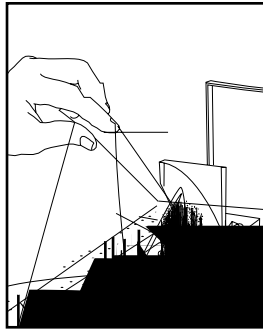

Fig. 12

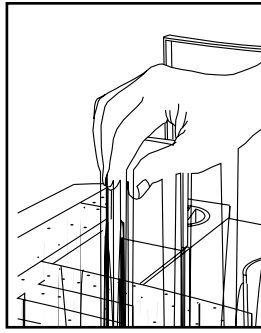

Fig. 13

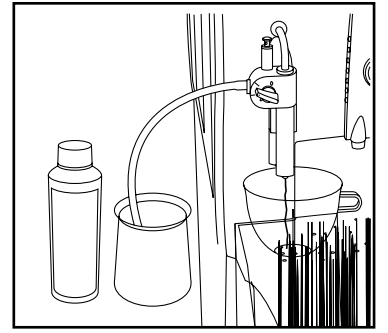

Fig. 14

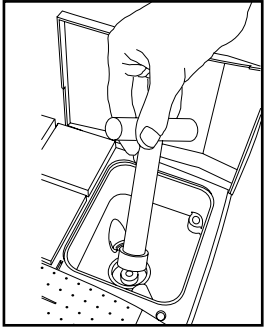

Fig. 15

Table of Contents

Chapter	Page	Chapter	Page
Important Safeguards.....	2	9. One-Touch Beverage Buttons.....	14
Jura-Capresso / Address Information.....	3	10. Brewing Coffee and Espresso	14
Illustrations.....	4-7	11. Overriding Strength and Cup Size during Brewing....	15
1. Product Warranty Registration.....	10	12. Auto Cappuccino System.....	15
2. Operating Instructions / Customer Service.....	10	13. Cappuccino and Latte	16
3. WELCOME TO THE IMPRESSA Z5	10	14. Overriding the Cappuccino Settings.....	16
a. "Crema Coffee" and Pressure Brewing.....	10	15. Hot Milk and Hot Chocolate	17
b. Different Coffee Drinks.....	11	16. Special Coffee Button.....	17
c. Coffee Facts.....	11	17. Cappuccino Rinsing Cycle.....	17
4. Please Don't / Please Do	11	18. Cappuccino Cleaning Cycle.....	18
5. Factory Settings.....	12	19. Cleaning the Dial Component.....	18
6. PREPARING MACHINE FOR THE FIRST TIME	12	20. Using Pre-Ground Coffee	19
a. Filling the Water Tank.....	12	21. Using Hot Water	19
b. Filling the Bean Container.....	12	22. Water Care.....	19
c. Turning the Machine On.....	13	23. Clearyl Water Filter Cartridge	20
7. Adjusting the Grinder.....	14	a Installing and Activating the Clearyl Cartridge ..	20
8. DAILY PREPARATION	14	b. Replacing the Clearyl Cartridge.....	20

8.

24.	Water Hardness Monitor	21
	a. Changing the Water Hardness Monitor	22
25.	Changing Pre-Set Cup Sizes.....	22
	25.1 1- and 2-Cup Buttons: Special Cup Button	22
	25.2 Cappuccino Button.....	22
	25.3 Milk Button.....	23
	25.4 Hot Water Button.....	23
26.	Programming / Maintenance	23

1. PRODUCT WARRANTY REGISTRATION

Please read the enclosed product registration form now. Fill it out and mail or fax it to us within two weeks after purchasing your machine or register online through our website: www.capresso.com.

Important: This registration is part of your warranty (chapter 35).

2. OPERATING INSTRUCTIONS / CUSTOMER SERVICE

Thank you for choosing this Jura-Capresso product.

- Please study these Operating Instructions carefully before using your new machine. We highly recommend viewing the enclosed DVD. Select Z5.
- Also included is a Quick Reference Guide. Keep it next to your machine until you are familiar with all functions.
- For further information please call our TOLL FREE number: 1-800-220-5701, Mon-Fri 9AM – 9PM & Sat 9AM – 5PM Eastern Standard Time. If you call at any other time please leave a message including your telephone number and a time you can be reached. You can send us a FAX at: 201-767-9684 or EMAIL us at contact@capresso.com.

Please note: if you lose your Operating Instructions or the Quick Reference Guide, you can download a printable copy from our website www.capresso.com.

3. WELCOME TO THE IMPRESSA Z5

This fully automatic coffee/espresso/cappuccino center is completely programmable and extremely user friendly. Your Impressa Z5 prepares a cup of cappuccino or latte at a push of a button without moving your cup, it brews one or two cups of crema coffee or espressos at a time, it produces unlimited amounts of

hot frothed and hot steamed milk and delivers up to 16 oz. hot water – all with a push of a button.

The two-step pressure brewing system – well known in commercial applications – was adapted and refined by Jura coffee specialists and is the trademark of each Jura-Capresso coffee center. This Pre-Brew Aroma-System ensures optimal coffee extraction and will finish every cup with a rich layer of "crema" – proof for perfectly pressure brewed coffee and espresso. Your Z5 grinds, tamps and brews completely automatically. The integrated solid steel conical burr grinder grinds beans to the preferred fineness. A separate funnel lets you use pre-ground coffee. All coffee, water and steam functions are programmable to your own personal taste. Make any size cup between 1 and 16 oz.

With two stainless steel lined Thermo-Block heating systems the Z5 is always ready to produce any kind of coffee drink with no downtime. The hot water function lets you prepare tea and other beverages in seconds.

All important functions such as water level, bean container, used coffee container and water filter are monitored automatically. You can program the machine to turn itself on and off, change the language and check how many cups of coffee you made. You can create your own names for any of the beverage buttons.

The beautiful, functional heavy duty die-cast metal front with its stainless steel appointments, cup illumination and informative LED display make the Z5 the most sophisticated and versatile Super Automatic Coffee Center available today. Enjoy your Impressa Z5!

3a. "CREMA COFFEE" AND PRESSURE BREWING

According to the majority of coffee experts, grinding, tamping

and brewing under high pressure is the ideal extracting process for maximum flavor and aroma. Your Jura-Capresso automatic coffee center will always produce espresso and coffee with a thick, foamy layer called "crema." The crema traps the fine aromatics and the light gaseous flavors that register on the palate. The high pressure and the short brewing time prevent the extraction of bitter oils and release less caffeine than any other brewing method. You will always make the absolute freshest and most aromatic cup of coffee. This is the reason why many European restaurants and hotels serve only fresh pressured brewed coffee. Experiment with your new machine and prepare yourself the best and most enjoyable cup of coffee!

3b. DIFFERENT COFFEE DRINKS

Here are some guidelines for the most popular coffee drinks:

- Ristretto: 1/2 to 1 oz. of coffee. Sweeten to taste.
- Espresso: 1 to 2 oz. coffee. Sweeten to taste.
- Double Shot: 3 to 4 oz. of coffee. Sweeten to taste.
- Crema Coffee: 5 to 8 oz. of coffee.
- Cappuccino: Espresso plus 3 to 4 oz. of hot frothed milk.
- Latte: Espresso plus 3-5 oz. steamed milk with little or no froth.
- Café Mocha: Make Espresso then add chocolate syrup to the milk before frothing/steaming.

TIP: Experiment with the size of your milk based drinks. For stronger coffee taste add more coffee, for more milk taste add more frothed milk.

3c. COFFEE FACTS

- **Caffeine** is tasteless. A "strong" coffee or espresso is mostly

the result of the amount of coffee in relation to the amount of water. The longer a bean is roasted, the less caffeine it has.

- **Arabica and Robusta** are two genetically different kinds of beans. "Arabica" beans have more flavor and a little less caffeine than "Robusta" beans which are mostly used in lower priced coffees and instant coffees.
- **Espresso** is not a bean, it's the way the coffee is roasted and prepared. Typical US espresso roasts result in darker beans with an oily surface. European espresso roasts are medium brown with no or very little oils on the surface.

All Display Messages Are Shown in **RED**

4. PLEASE, DON'T... (or you void your warranty protection):

- Never pull out the drawer during the brewing process. Only pull the drawer when the display instructs you or when the display shows **COFFEE READY**.
- Never fill instant coffee into the bean container or ground coffee funnel; it can damage the brewing chamber.
- Never fill sugar coated coffee beans into the bean container.
- Never fill frozen beans into the bean container. If you store beans in the freezer, let them thaw 3 to 4 hours before filling them into the bean container.
- Never fill anything other than coffee beans into the bean container (no chocolate, rice, nuts, spices, etc.)
- Never fill anything but fresh, cold clean water into the water container, except when decalcifying (chapter 29).
- Never use mineral or carbonated water. You can use tap water, bottled water, spring water, distilled water and reverse osmosis water.

- Never repair or open the machine yourself. All repairs should be performed only by an authorized service center.

PLEASE, DO...

- Fill water tank with fresh, cold water only.
- Remove any foreign particles (small stones) from coffee beans.
- Let frozen beans thaw 3 to 4 hours before pouring them into the bean container.

5. FACTORY SETTINGS

Each machine leaves the factory with the following settings:

- Milk Button 20 seconds
- Cappuccino Button 15 seconds milk, 3 oz. coffee, strength NORMAL, temperature HIGH:
- Special Coffee Button 3 oz., XSTRONG, HIGH
- Hot Water Button 6 oz.
- 1 Espresso Button..... 1.5 oz., STRONG, HIGH
- 2 Espresso Button..... 3.0 oz., STRONG, HIGH
- 1 Coffee Button 5.0 oz., NORMAL, HIGH
- 2 Coffee Button 10.0 oz., NORMAL, HIGH

Please note: You can change all above presets (chapter 26). You can also override the strength and the cup size before/during actual brewing. Overriding will not change the preset values.

- Filter No (not installed) (chapter 23)
- Hardness Level..... 10° (chapter 24)
- Auto-Off..... 2 Hours (chapter 26.9)
- Grinder Fineness Middle position (chapter 7)
- Economy NO SAVE (chapter 26.6)

- Time format AM/PM (chapter 26.13)
- Volume ml/oz..... in ounces (chapter 26.13)
- Language English (chapter 26.12)
- Time Not set (chapter 26.7)
- Unit On (Auto-On) Not set (chapter 26.8)

CUP ILLUMINATION (Fig. 1,7)

The cup illumination adds a dramatic touch to brewing coffee. Providing the main power switch is on, you can activate the cup illumination for 1 minute by pressing any button.

6. PREPARING THE MACHINE FOR THE FIRST TIME

- Make sure all accessories, literature and any other items are removed from the bean container and the water tank.
- DO NOT install the Clearyl water filter now. (chapter 23)
- Make sure the machine sits on an even, flat surface and the drawer, tray and used coffee container are inserted (Fig.1, Fig. 2).
- Plug-in machine.

6a. FILLING THE WATER TANK

Please note: Only use fresh, cold water. Never fill water tank with carbonated water, milk or any other liquid.

- Open the Water Tank Lid, remove the water tank, rinse and fill with fresh, cold water (Fig. 7).
- Replace water tank and make sure that the two slots are engaged over the two hooks to secure the tank properly.
- Close lid.

6b. FILLING THE BEAN CONTAINER

Please note: To insure that your conical burr grinder will work for a long time, do not use it with any kind of coated or flavored

beans (all coating and flavors contain sugar or sugar substances). Such coating can damage the burrs. Using such beans voids the warranty. Have your coffee store grind the sugar coated beans and use as described in the ground coffee funnel (chapter 20). **Please note:** If you like flavored coffees we recommend to add flavors to your coffee after brewing. This way you can use your regular coffee beans in the bean container. Adding the flavors after brewing lets you control the intensity much better than with pre-flavored coffee. Your local coffee store typically carries a variety of flavors.

- Open the Cover Lid (Fig.1,1).

Please note: The cover lid is spring activated. Push slightly upwards on the right side finger indent and the lid will automatically open.

- Remove the see-through Bean Container Safety Lid (Fig. 4). Make sure the bean container is empty and clean. Fill beans into the bean container. Replace the Safety Lid.

Attention: the machine will not work without the Safety Lid in place. Close the Cover Lid.

Frozen Beans: Thaw 3 to 4 hours before adding to bean container. This prevents moisture from seeping into the grinder.

Oily Beans: Beans with an oily surface tend to stick together. This may prevent a continuous flow of beans from the bean container into the burrs. As a result the grinder does not grind enough coffee and you might get weak or no coffee at all. Stir the beans in the bean container just before grinding. Alternatively, you can also pour the beans in an open bowl and let them sit for about 5 hours. The oils will evaporate (this will

not change the taste of your coffee). Then fill the beans into the bean grinder. Now beans will feed into the burrs more easily.

6c. TURNING THE MACHINE ON

- Press the Main Power Switch at the bottom left in front of the power cord (Fig. 3a). The On/Off button on top of the machine illuminates (Fig. 3).
- Push the On/Off button on top of the machine. The display will illuminate. **PRESS RINSE**. The Rinse Button (Fig. 3) illuminates in blue.
- Place one cup underneath the Hot Water Spout (Fig. 1,6) and one cup underneath the Auto Cappuccino System (Fig. 1,13).
- Push the Rinse Button. **SYSTEM FILLS**. The machine starts pumping water into the system, until some water will come through the cappuccino nozzle and the hot water spout. During this operation the Rinse Button flashes.

**WELCOME TO JURA
UNIT IS HEATING
PRESS RINSE**

- Place a cup underneath the Dual Coffee Spouts (Fig. 1,5) and push the Rinse Button. The machine will pump a bit of hot water through the coffee spouts and will stop automatically. **COFFEE READY**
- Place a cup underneath the Dual Coffee Spout and push the 1-cup Espresso Button (Fig. 3). The machine starts grinding and brewing. The display might show **FILL BEANS**.
- Push the 1-cup Espresso Button again. Discard the first two cups of coffee. Your next cup will be perfect.

Important: After the initial set up we recommend to leave the Main Power Switch on for the next 24 hours. This will give the

Z5 enough time to completely charge its internal back-up battery. When fully charged, the internal battery will back up the clock for up to eight weeks.

7. ADJUSTING THE GRINDER

You can adjust the grinder to the roast of your coffee.

We recommend the following:

Light roast: use a finer adjustment.

Dark roast: use a coarser adjustment.

- Open the Cover Lid (Fig. 1,1)
- While the grinder is running, turn the Grind Selector to the desired position (Fig. 4).

Coarser: Turn the dial towards the bean symbol.

Finer: Turn the dial away from the bean symbol.

Important: The grinding grade can only be adjusted while the grinder is actually grinding.

8. DAILY PREPARATION

We recommend filling the water container every morning with fresh, cold water. This will enhance the taste of your coffee.

- Make sure the Main Power Switch is on (Fig. 3a). In this case the On/Off button on top is illuminated.
- Push the On/Off button on top of the machine. The display shows **MACHINE IS HEATING**. After approx. 2 minutes the display shows **RINSE**.
- Push the Rinse Button (Fig. 3). Hot water will warm up all internal parts and pump through the coffee spouts. The water will be caught in the drawer underneath. The rinse cycle stops by itself and the display reads: **COFFEE READY**. You are now ready to make coffee.

9. ONE-TOUCH BEVERAGE BUTTONS (Fig. 3)

The Z5 has eight beverage buttons. The first three buttons on the left side produce beverages coming out of the Auto-Cappuccino-System on the left side of the machine. The fourth button on the left side produces hot water through the hot water spout (Fig.1,6).

The four buttons on the right side produce different kinds of coffee beverages through the Dual Coffee Spout in the middle. All beverage buttons are pre-set to certain volumes and strengths (chapter 5).

10. BREWING COFFEE AND ESPRESSO

(1 Espresso, 2 Espressos, 1 Coffee, 2 Coffees)

The four buttons on the right side of the Operating Panel (Fig. 3) deliver coffee through the Dual Coffee Spouts (Fig. 1,5).

- Place one or two cups underneath Dual Coffee Spouts and push the desired button.

The Impressa Z5 will grind, tamp and then brew the coffee. It uses a 2-step brewing process (Pre-Brew Aroma System). First, it moistens the ground coffee (pre-brew phase), pauses for a few seconds, and then starts the brewing process. The display will show the name of the button you pushed, e.g.

1 ESPRESSO and then the strength which was programmed for this button, e.g. **STRONG**. The brewing process stops automatically as soon as the programmed volume of coffee is produced. When the display shows **COFFEE READY** you can brew the next cup of coffee.

Very Important: After the brewing stops the Z5 will discard the used coffee. **Please do not try to pull out the drawer (Fig. 2) during this time. It can seriously damage the machine.** There

is no need to pull out the drawer unless you see the message **EMPTY GROUNDS** (chapter 27.4).

Please note: You can always stop the brewing process by pressing the Rotary Dial or any of the eight beverage buttons. This will not affect the pre-set values.

11. OVERRIDING STRENGTH AND CUP SIZE DURING BREWING.

With the Z5's override feature you are always able to change certain settings just before brewing without affecting the pre-set values. This is a great feature if you are in the mood for a different kind of coffee which is not programmed. (For changing pre-set values see chapter 25 and 26).

For the four coffee buttons on the right side, you can override the strength and the coffee volume.

COFFEE READY

- First turn the Rotary Dial. It will display five different strength settings **XMILD, MILD, NORMAL, STRONG, XSTRONG**.
- Select the one you like and then push one of the four coffee buttons. Once you pushed the coffee button, the display will again show the strength setting you just selected.
- You can now change the coffee volume.
- Turn the Rotary Dial and the display will show the coffee volume in oz. Turn the dial until the desired volume is set.

Please note: When you select a different strength you must push one of the coffee buttons within the next 3 seconds, otherwise the Z5 reverts back to **COFFEE READY**.

Please note: When you push one of the double cup buttons and you change the volume, the display will always show the volume

per cup, e.g. if you choose 7 oz. the Z5 will actually brew a total of 14 oz.

Example: The 1-cup Espresso button is programmed to **STRONG** and approx. **1.5 OZ.**

Assume you want to use this button to make a MILD 4 oz. cup. **COFFEE READY**

- Turn the Rotary Dial until the display shows **MILD**, push the 1-cup Espresso button. The Z5 starts grinding and displays **MILD**.
- When it starts brewing, turn the Rotary Dial until the display shows **4.0 OZ.**

The next time you use the 1-cup Espresso button it will produce the pre-set value **STRONG, 1.5 oz..**

12. AUTO CAPPUCCINO SYSTEM

The three buttons on the left side of the operating panel produce beverages which are brewed through the Auto Cappuccino System (Fig. 1,13). We recommend watching the DVD.

The Auto Cappuccino System has the following components:

- Dual fixed spouts coming out of the machine, (Fig. 5).
- Dial Component with the small removable venting tip (Fig. 5a).
- The removable Dual Nozzle system. The long system is already attached to the machine. If you use tall cups or glasses you can replace the long Dual Nozzle System with a shorter one (Fig. 5b). It is included in the Welcome Pack.

The nozzle that is positioned closer to the machine will deliver coffee, this is called the Coffee Nozzle (Fig. 5e). The nozzle in the front will deliver hot steamed and frothed milk, this is called the Milk Nozzle (Fig. 5e).

Please note: There is a gap between the Coffee Nozzle and the fixed coffee spout. (Fig. 5e) This is necessary to assure proper coffee flow.

Please note: The Milk Nozzle should always be tightly connected to the Dial Component (Fig. 5e) and the venting tip needs to be clean and inserted to assure proper frothing action (Fig. 5a).

- A Thermal Milk Container with lid (Fig. 6a).
- Two stainless steel rods and two flexible hoses (Welcome Pack).

13. CAPPUCCINO AND LATTE

Make sure the Auto-Cappuccino-System is installed properly (Fig. 5a – 5e).

- Fill cold milk into the Thermal Milk Container and assemble the two stainless steel rods with the lid as shown in Fig. 6 .
- Attach the short flexible hose to the rod and insert the connector into the Dial Component (Fig. 6a).

Cappuccino: The Dial points to the cup with saucer. Hot milk and milk froth will be created (Fig. 5f).

Latte: The Dial points to the tall glass. Hot steamed milk with no or very little froth will be created.

COFFEE READY

- Place a cappuccino cup underneath the Dual Nozzle System. The cup should have at least a 8 oz. capacity. Make sure the dial points to the cappuccino setting (Fig. 5f).
- Push the Cappuccino Button (Fig. 3).

CAPPUCCINO

The Z5 begins grinding the coffee and at the same time starts siphoning the cold milk.

MILK 15 SEC.

Hot frothed milk is automatically delivered into your cup. Frothing stops automatically.

3 OZ. NORMAL. Now the Z5 automatically adds high pressure brewed coffee and then stops automatically.

COFFEE READY

Tip: If you use a glass cup you can actually see how much froth is created and how the coffee goes through the froth and sits underneath the layer of milk froth. Slightly stir to distribute the coffee evenly into the hot milk.

14. OVERRIDING THE CAPPUCCINO SETTINGS

As with the other buttons you can always override the pre-sets of the cappuccino button.

Example: Let's override

- the coffee strength from NORMAL to XSTRONG,
- the milk frothing time from 15 seconds to 10 seconds,
- the coffee volume from 3 OZ to 2 OZ.

COFFEE READY

- Place a cup underneath the Dual Nozzle System.
- Turn the Rotary Dial until the display shows **XSTRONG**.
- Push the Cappuccino button.
- When the display shows **MILK 15 SEC**, turn the Rotary Dial until the display shows **10 SEC**.
- When the coffee starts brewing turn the Rotary Dial again until the display shows **2 OZ**.

Please note: You can stop frothing by pushing any of the beverage buttons or the Rotary Dial. The Z5 will stop frothing and will start brewing the coffee. You can stop the coffee brewing in the same way.

Please note: Cold milk will stay fresh up to 8 hours in the thermal milk container. Do not leave the milk sitting outside the refrigerator over night.

Please note: If there is not enough milk in the milk container, the frother nozzle will dispense steam only. Stop the frothing action and refill the milk container.

Please note: If the Dial points to the cappuccino position and you do not get froth on your milk, check the following items:

- a. Make sure all connections are tight.
- b. Remove the venting tip (Fig. 5a) and squeeze the bottom part. Milk might have closed the venting lip. Replace venting tip.
- c. Skim milk will create considerably more froth than regular milk. Soy milk will produce very little froth.

15. HOT MILK AND HOT CHOCOLATE

The Milk Button (Fig. 3) lets you produce hot milk or hot chocolate.

- Connect the long hose to the Dial system and insert the other end into the container with cold milk or cold chocolate milk.
- Set the Dial to the cappuccino or the latte setting.
- Place a cup underneath the Auto Cappuccino System.

COFFEE READY

- Push the Milk Button

The display shows **MILK 20 SEC**. The Z5 will produce hot milk for 20 seconds and then stop automatically.

You can always change the duration by turning the Rotary Dial. You can stop the milk flow by pushing the Rotary Dial or any beverage button.

Tip: Without moving the cup you can now add coffee using the Special Coffee Button. .

16. SPECIAL COFFEE BUTTON

COFFEE READY

- Place a cup under the Auto Cappuccino System. Make sure the long or the short nozzle system is installed.
- Push the SPECIAL COFFEE button (Fig. 3). The Z5 will brew a cup coffee from the back nozzle and will stop automatically. This button is useful if you want to create special milk drinks that are not pre-set with any of the other buttons.
- As explained in chapter 11, you can change the strength and the volume for this button, just before brewing.

17. CAPPUCCINO RINSING CYCLE CAPPU RINSE

Ten minutes after using the milk or the cappuccino buttons, the display will show the messages **CAPPU RINSE, COFFEE READY, CAPPU RINSE** and so on. At the same time the Rinse Button will illuminate.

- Place a cup underneath the Auto Cappuccino System.
- Turn the Dial all the way down to the steam position (Fig. 5f).
- Push the rinse button. **CAPPUCCINO RINSING**. For a few seconds the Z5 will push hot water through the Dual Nozzle System to remove any milk deposits.

COFFEE READY

- Turn the selector switch back to the Cappuccino or Latte position.
- Please note:** If the **CAPPU RINSE** message appears and you do not plan to use the milk or cappuccino button within the next few minutes, we highly recommend to run this rinse cycle without delay. Warm milk inside the dual nozzle will deteriorate within a short period of time and milk fats can create foul smells.

Please note: You can also perform a cappuccino rinsing cycle manually using maintenance menu (chapter 26.1).

Please note: When you are finished using the cappuccino feature for the day please proceed as follows:

- a. Remove the Thermal Milk container and place in the refrigerator.
- b. Remove the flexible hose on both ends and clean with hot water.
- c. Pull off the Dial component and the Dual Nozzle and rinse under warm water.

18. CAPPUCCINO CLEANING CYCLE

Milk contains fatty acids. Hot water alone may not always remove milk fats completely. If you use the cappuccino feature frequently or if you use the Z5 for commercial purposes we highly recommend to perform this cleaning cycle daily. It will take less than two minutes.

Please note: the Z5 will not prompt you to run this special cycle.

T theisd py shlls.

20. USING PRE-GROUND COFFEE

You can also use pre-ground coffee, bypassing the grinder. This comes in handy if someone requests decaf coffee or a decaf cappuccino. You can also use the pre-ground funnel for ground flavored coffee.

Please note: Never fill the funnel with instant coffee. Do not fill the funnel with more than two scoops. The funnel is not a storage container. If coffee is ground too fine it might be processed very slowly or the Z5 will interrupt the process altogether.

COFFEE READY

- Place one or two cups under the Dual Coffee Spouts or the Auto Cappuccino System. Open the Cover Lid and then open the Lid for Ground Coffee (Fig. 4). Opening this lid automatically disengages the grinder. The display shows **PRE-GROUND FILL POWDER**.
- Add one or two level scoops of pre-ground coffee into the funnel and close the lid (Fig. 12). The display shows **PRE-GROUND SELECT PRODUCT**.
- Push any of the six coffee producing buttons. The Z5 will brew the selected beverage. During brewing you can still change the coffee volume by turning the Rotary Dial.

COFFEE READY

Please note: If you inadvertently opened the lid for the coffee funnel, just close it. The Z5 will detect that there is no coffee in the funnel. The display will show **PRE-GROUND NOT ENOUGH** and will return to **COFFEE READY**.

Please note: After use of sugar coated or flavored coffee through the pre-ground coffee funnel you may experience some flavor transfer when switching back to your regular coffee. Select

the program **RINSE UNIT** in the maintenance section to run some hot water through the coffee spouts (chapter 26.1)

21. USING HOT WATER

The Z5 can produce up to 16 oz. of hot water. This is great if you want to produce a hot cup of tea or instant soup or if you want to add some hot water to your coffee.

COFFEE READY

- Place a cup underneath the Hot Water Spout (Fig. 1,6)
- Push the Hot Water Button (Fig.3). The display shows **HOT WATER PORTION**.

The pre-set is 6 oz. You can change the hot water volume during brewing by turning the Rotary Dial. You can always stop the hot water output by pushing any of the beverage buttons.

22. WATER CARE

Water is heated inside the Z5. With use, this leads to calcium deposits forming inside the machine. With the Z5 you have the following options to take care of the water:

Most convenient: Clearyl Water Filter Cartridge (chapter 23).

Least expensive: Decalcifying System (chapter 24 and 29).

Your Z5 is pre-set in the factory to automatically remind you to decalcify based on a water hardness of **10° DH** = 13 grains. You can change the water hardness setting to comply with the water you are using (chapter 24).

Please note: The Z5 will automatically remind you when it is necessary to run certain water maintenance programs. It is important that you follow those instructions. Otherwise your Z5 might break down.

23. CLEARYL WATER FILTER CARTRIDGE

The machine comes with one Clearyl Water Filter Cartridge. The Clearyl cartridge

- Reduces the water hardness up to 75%.
- Removes (if present) up to 85% chlorine, up to 90% lead, up to 95% copper and up to 67% aluminum.
- Cleans the water through an upward current principle (Fig. 9) just before the brewing cycle starts, ensuring freshly filtered water every time you make coffee.
- Eliminates decalcifying except when using very hard water (25 grains or higher), see chapter 24. In this case we recommended to decalcify the Z5 once or twice a year.
- To reorder cartridges, see chapter 34.

23a. INSTALLING & ACTIVATING THE CLEARYL WATER CARTRIDGE

Installing:

Important: Never install the cartridge before or during

"Preparing Machine For The First Time" (chapter 6).

- Remove cartridge from its bag and rinse cartridge under water.
- Add the extension rod to the cartridge (Fig.8).
- Remove the water tank, make sure it is empty.
- Pull up the cartridge holder and insert the cartridge with its tapered end down (Fig. 10). Make sure it fits securely over the white mesh piece inside the water container. Push down gently (Fig. 11).
- Close the cartridge holder. Make sure the holder snaps into place.
- Fill the water tank with fresh cold water and replace.

Activating:

You must activate the cartridge otherwise the Z5 cannot monitor it properly and assumes that the machine is still in decalcifying mode.

COFFEE READY

- Push the Rotary Dial until you hear a beep.
- **FILTER NO**
- Push the Rotary Dial again, to enter the **FILTER** program.
- Turn the Rotary Dial until the display shows **FILTER YES** and push the Rotary Dial to confirm. The display shows **INSERT FILTER PRESS BUTTON** and the Rinse Button illuminates.
- Place a 20 oz. container under the Auto Cappuccino System.
- Push and hold the Rinse Button until the display shows **FILTER RINS**. For the next 90 seconds the Z5 will push water through the cartridge and out through the milk nozzle. Initially, the water may have a slight discoloration. The program will stop automatically. The display shows **UNIT IS HEATING** and then **COFFEE READY**.

Please note: If your container is not large enough, you can interrupt the activation cycle by simply pressing any beverage button. The display shows **PRESS BUTTON** and the Rinse Button is still illuminated. Replace the empty container and continue the filter activation by pressing the Rinse Button.

Please note: As long as the filter is activated, the water hardness setting is automatically turned off.

23b. REPLACING THE CLEARYL WATER CARTRIDGE

The filter is monitored automatically. After approx. 75 liters of water (~2,500 oz.) the display shows **COFFEE READY** and **FILTER-CHANGE**. The Rinse Button will light up.

Please note: We recommend to set the time (chapter 26.7). If you have not used 75 liters of water in three months, the filter monitor will indicate that a filter change is necessary.

Important: Once the filter has lost its calcium suppressing abilities, calcium will build up inside the machine. Since the Water Hardness Selector is off, the machine will not remind you when to decalcify. This could clog and ruin your machine.

- Push the Rinse Button. **INSERT FILTER PRESS BUTTON.**
- Remove the old filter and set the extension rod aside. The used filter cartridge is environmentally friendly and can be disposed with your regular household trash.

Important: Keep the Extension Rod

- Make sure the water tank is empty.
- Remove the new cartridge from its bag and rinse under running water. Now install as explained in chapter 23A.
- Place a 20 oz. container under the Auto Cappuccino System.
- Push and hold the Rinse Button until the display shows **FILTER RINS.** For the next 90 seconds the Z5 will push water through the cartridge and out through the milk nozzle. Initially, the water may have a slight discoloration. The program will stop automatically. The display shows **UNIT IS HEATING** and then **COFFEE READY.**

24. WATER HARDNESS MONITOR

If you do not use the Clearyl Filter Cartridge (chapters 23 – 23B.) the Z5 will remind you when it is time to perform a decalcifying cycle. The machine is set to medium hard water. If you have harder water you need to set it to a higher level. If you have softer water you can set it to a lower level. If you are not sure about the hardness of your water, ask your local water company for the

"Water Hardness in Grains." The Z5 will show you the water hardness in the German hardness scale (which is a bit different from the American "Grain" scale (see chart below).

You can also use the enclosed water hardness indicator strip to determine the water hardness:

- Insert the stick for one second into the water you want to use. Shake off any excess water and wait for one minute.
- If all five fields of the test stick turn reddish, set the hardness level to 5 squares. If four fields turn reddish, set the hardness level to 4 squares and so on.

Please note: If you use Spring Water or Bottled Water you can set the hardness level to 1, "extremely soft water".

The Z5 will give you the following options:

Level	Display	Display German Degree	Equivalent American Grains	Indicator Strip number of "reddish" fields
Not Active*	Not Active	—	—	—
1. extremely soft water	☐	1-4	1-5	None
2. soft water	■	5-9	6-11	1 to 2
3. medium water	■ ■	10-14	13-18	2 to 3
4. hard water	■ ■ ■	15-19	19-24	3 to 4
5. very hard water	■ ■ ■ ■	20-24	25-30	4 to 5
6. extremely hard water	■ ■ ■ ■ ■	25 +	32 +	All 5

*Not Active: You can only use this setting for distilled water.

Level 5 and Level 6: If your tap water is very hard and falls into these two categories, decalcifying will be frequent. In this case bottled water is recommended.

Please note: If your water has a high calcium content (level 5 or 6) and you use the Clearyl Filter Cartridge we recommend to decalcify the Z5 once or twice a year (chapter 26.1).

24a. CHANGING THE WATER HARDNESS MONITOR

COFFEE READY

- Push the Rotary Dial until you hear a beep.
- FILTER**
- Turn the Rotary Dial until the display shows **HARDNESS 10° DH**
 - Push the Rotary Dial to enter the program.
 - Turn the Rotary Dial until desired hardness level is displayed.
 - Push the Rotary Dial to confirm the setting.
 - Turn the Rotary Dial until the display shows **EXIT**.
 - Push the Rotary Dial.

COFFEE READY

The Z5 will automatically remind you when it is time to decalcify (chapter 29).

25. CHANGING PRE-SET CUP SIZES

Each beverage button has been set to certain values (pre-sets). See chapter 5. You can change all pre-set values and enter ones.

25.1 1-AND 2-CUP BUTTONS; SPECIAL CUP BUTTON

This procedure is the same for all five coffee buttons (Fig. 3).

COFFEE READY

EXAMPLE: Changing the 1-cup Coffee Button. (Fig.3).

- Place a cup underneath the coffee spouts.
- Push and hold the 1-cup Coffee Button until the display shows **ENOUGH? PRESS BUTTON**.

- When the coffee volume in your cup is at the new desired level, push the 1-cup Coffee Button again. The display shows **CONFIRMED ✓**
COFFEE READY

From now on, this will be the amount of coffee the Z5 will produce when you push this button.

Please note: the 1-cup and 2-cup buttons are independent of each other. This means if you pre-set the 1-cup coffee button to 4 oz. the 2-cup button does not automatically produce 8 oz. You can pre-set the 2-cup button completely independent.

Please note: when changing the volume for the special cup button, place a cup under the auto cappuccino system.

25.2 CAPPUCCINO BUTTON

You can change the pre-set volumes for milk and coffee. This allows you to adjust the volume exactly to your cup size. Place a cup underneath the auto cappuccino system.

COFFEE READY

- Push and hold the Cappuccino Button until the display reads **ENOUGH MILK PRESS BUTTON**.
- Once you have enough frothed milk in your cup, push the Cappuccino Button again. Now the Z5 starts brewing the coffee and the display shows **ENOUGH? PRESS BUTTON**.
- Once enough coffee has been added to your cappuccino, press the Cappuccino Button again. The display shows **CONFIRMED ✓**
COFFEE READY

Please note: You can also change the pre-set parameters for the cappuccino button in programming (chapter 26.4)

25.3 MILK BUTTON

You can change the pre-set milk volume.

- Place a cup underneath the Auto Cappuccino System.
COFFEE READY
- Push and hold the Milk Button until the display reads **ENOUGH MILK PRESS BUTTON**.
- Once you have enough frothed milk in your cup push the Milk Button again. The display shows **CONFIRMED ✓**.
COFFEE READY

Please note: You can also change the pre-set parameters for the milk button in programming (chapter 26.5)

25.4 HOT WATER BUTTON

You can change the pre-set hot water amount.

- Place a cup underneath the hot water spout.
COFFEE READY.
- Push and hold the Hot Water Button until the display reads **ENOUGH WATER PRESS BUTTON**.
- Once you have enough hot water in your cup push the Hot Water Button again. The display shows **CONFIRMED ✓**.
COFFEE READY

26. PROGRAMMING / MAINTENANCE

The Z5 provides programming, maintenance and look-up functions. With the display at **COFFEE READY** you can access these functions as follows:

- Push and hold the Rotary Dial until you hear a beep and the display shows **FILTER**.

The Z5 offers the following Functions (see adjacent chart)

Turn the dial clockwise slowly to scroll through Functions.

Please note: to get back to **COFFEE READY**, turn the Rotary Dial until the display shows **EXIT**, then push the Rotary Dial.

Function	Display	Comment	Chapter
Clearlyl Water Filter	FILTER NO or FILTER YES	Install and activate the Clearlyl Filter	23A
Water Hardness (if FILTER is set to YES, this function is suppressed)	HARDNESS	Change water hardness (when not using the Clearlyl Filter)	24A
e/(a)0mpera, (pr)1	.the1fasbutctio	upprsor milbacimeall acZ5 of	

Function	Display	Comment	Chapter
Time	TIME	Set actual time	26.7
Auto-On	UNIT ON	Choose an auto-on time	26.8
Auto-Off	OFF AFTER	Choose an auto-off time after last use	26.9
Information	INFORMATION	Check performance and a variety of settings	26.10
Renaming display message	RENAME	Rename the beverage buttons, the "on" and "off" messages	26.11
Language	LANGUAGE	Change the display to another language	26.12
Display	DISPLAY	Choose cup size info. in OZ. to ML. Choose time display in 24HRS or AM/PM mode	26.13
Exit programming	EXIT	The only way to get back to COFFEE READY	

26.1 MAINTENANCE PROGRAMS

COFFEE READY

- Push and hold the Rotary Dial until you hear a beep and the display shows **FILTER**.
- Turn the dial until the display shows: **MAINTENANCE**

- Push and turn the Rotary Dial to select from the following Maintenance Programs:
RINSE UNIT
CAPPUCCINO CLEANING
CHANGE FILTER (this program will only show up if **FILTER** is set to **YES**)
CLEAN UNIT
CAPPUCCINO RINSING
DECALCIFY UNIT.

To activate one of the above programs, push the Rotary Dial and follow the instructions on the display.

Please note: If you do not select any of the Maintenance Programs, the display will return to **COFFEE READY**.

26.2 TEMPERATURE

You can set the coffee temperature for the Cappuccino Button, the Special Coffee Button and the four coffee buttons on the right side to LOW, NORMAL or HIGH. The factory setting for these buttons is HIGH. The temperature difference between LOW and HIGH is approx. 7° F.

Please note: the temperature also depends somewhat on the fineness setting of the grinder (chapter 7). The finer the grind the slower the water will pass through the coffee causing it to get somewhat hotter.

Changing the temperature:

COFFEE READY

- Push and hold the Rotary Dial until you hear a beep and the display shows **FILTER**.
- Turn the dial until the display shows: **TEMPERATURE**

- a. Push the Rotary Dial. **SELECT PRODUCT**.
- b. Push the beverage button for which you want to change the temperature, e.g. the 1-cup Espresso Button. The display shows **1 ESPRESSO HIGH**.
- c. Turn the Rotary Dial and select **NORMAL** (example).
- d. Push the Rotary Dial to confirm. **CONFIRMED ✓**
- e. **TEMPERATURE**. To change another beverage button start with a. again.

26.3 COFFEE STRENGTH / AROMA

You can set the coffee strength for the Cappuccino Button, the Special Coffee Button and the four coffee buttons on the right side to **XMILD, MILD, NORMAL, STRONG, XSTRONG**. For factory settings see chapter 5. In **XMILD** the 1-cup buttons grind for about 4 seconds, in **XSTRONG** for about 8 seconds. The 2-cup buttons grind between 7 and 10 seconds respectively. The minimum amount of coffee to be ground is approx. 5 grams, the maximum approx. 16 grams.

Please note: the amount of ground coffee also depends on the fineness settings of the burr grinder. The coarser the setting the more coffee is ground through the burrs.

COFFEE READY

- Push and hold the Rotary Dial until you hear a beep and the display shows **FILTER**.
 - Turn the dial until the display shows: **AROMA**
- a. Push the Rotary Dial. **SELECT PRODUCT**.
 - b. Push the beverage button for which you want to change the coffee strength, e.g. the 2-cup Coffee Button. The display shows **2 COFFEE NORMAL**.
 - c. Turn the Rotary Dial and select **XSTRONG**.

- d. Push the Rotary Dial to confirm. **CONFIRMED ✓**
- e. **AROMA**. To change another beverage button start with a.

26.4 CAPPUCCINO PROGRAMMING

Chapter 25.2 explains how to change the pre-sets for milk and the coffee volume while the Z5 is brewing. In programming you can simply change the pre-sets by changing the values shown in the display without making the beverage.

COFFEE READY

- Push and hold the Rotary Dial until you hear a beep and the display shows **FILTER**.
 - Turn the dial until the display shows: **CAPPUCCINO**
- a. Push the Rotary Dial. The display shows **MILK 15 SEC**
 - b. Turn the Rotary Dial until the desired duration is displayed, e.g. **MILK 20 SEC**.
 - c. Push the Rotary Dial to confirm. **CONFIRMED ✓**.
Now the display shows **COFFEE 3 OZ**.
 - d. Turn the Rotary Dial until the desired coffee volume is displayed, e.g. to **COFFEE 5 OZ**.
 - e. Push the Rotary Dial to confirm. **CONFIRMED ✓**
Now the display shows **CAPPUCCINO MILK 20 SEC**.
 - f. Turn the Rotary Dial until the display shows **EXIT** and push the Rotary Dial.
COFFEE READY

26.5 MILK PROGRAMMING

Chapter 25.3 explains how to change the pre-sets for milk volume while the Z5 is brewing. In programming you can simply change the pre-set by changing the duration shown in the

display without using any milk

COFFEE READY

- Push and hold the Rotary Dial until you hear a beep and the display shows **FILTER**.
 - Turn the dial until the display shows: **MILK**
 - a. Push the Rotary Dial. The display shows **MILK 20 SEC**
 - b. Turn the Rotary Dial until the desired duration is displayed, e.g. **MILK 30 SEC**.
 - c. Push the Rotary Dial to confirm. **CONFIRMED ✓**
Now the display shows **MILK 30 SEC**.
 - d. Turn the Rotary Dial until the display shows **EXIT** and push the Rotary Dial.
- COFFEE READY**

26.6 ENERGY SAVING SETTINGS

The factory setting is **SAVE NO**.

Two other settings are possible: **SAVE LEVEL 1** and **SAVE LEVEL 2**.

SAVE NO:

The Z5 is always in immediate stand-by mode. You can make coffee and steam and froth milk without delay as long as the machine is on.

SAVE LEVEL 1:

The Z5 is in constant stand-by mode for coffee and in energy saving mode for steam.

If the Z5 is mostly used for coffee this setting will consume less energy. When using the cappuccino or milk button, the Z5 will first heat up for about 30 seconds and then prompt you again.

SAVE LEVEL 2:

Five minutes after last use, the Z5 will lower the stand-by temperature to economy. When making coffee at a later time, the machine will first heat up for up to 30 seconds.

This setting will save energy if you prepare only a few coffees or cappuccinos in large intervals. It is still much faster than turning the machine on every time you want to make coffee.

COFFEE READY

- Push and hold the Rotary Dial until you hear a beep and the display shows **FILTER**.
 - Turn the dial until the display shows: **ENERGY SAVE NO**.
 - a. Push the Rotary Dial.
 - b. Turn the Rotary Dial until the desired setting shows up, e.g. **SAVE LEVEL 1**.
 - c. Push the Rotary Dial to confirm. **CONFIRMED ✓**
Now the display shows **ENERGY SAVE LEVEL 1**.
 - d. Turn the Rotary Dial until the display shows **EXIT** and push the Rotary Dial.
- COFFEE READY**

26.7 ACTUAL TIME

Setting the time allows you to program an auto-on time. Also, when using the Clearyl Filter, the Z5 will indicate a filter change after approx. 3 months if you do not use 75 liters of water within that period.

COFFEE READY

- Push and hold the Rotary Dial until you hear a beep and the display shows **FILTER**.
- Turn the dial until the display shows: **TIME**
- a. Push the Rotary Dial. The display shows **TIME HOURS**

- b. Turn the Rotary Dial until the hours are set.
- c. Push the Rotary Dial to confirm. The display shows **TIME MINUTES**.
- d. Turn the Rotary Dial until the minutes are set.
- e. Push the Rotary Dial to confirm. Display shows **CONFIRMED ✓** and shows the actual time.
- f. Turn the Rotary Dial until the display shows **EXIT** and push the Rotary Dial.
COFFEE READY.

Please note: For Daylight Saving you have to re-set the time.
Please note: When fully charged, the built-in back up battery will keep the clock running for up to eight weeks in case the Z5 is unplugged or the main power switch on the left side is turned off.

26.8 AUTO-ON

You can set a time at which the Z5 turns itself on. This way you don't have to wait for the machine to warm up. Just run one 10 second rinse cycle and you are ready for your first cup of coffee. First you need to set the actual time (chapter 26.7).

COFFEE READY

- Push and hold the Rotary Dial until you hear a beep and the display shows **FILTER**.
- Turn the dial until the display shows: **UNIT ON**
- a. Push the Rotary Dial. The display shows **HOURS**
- b. Turn the Rotary Dial until the hours are set.
- c. Push the Rotary Dial to confirm. The display shows **MINUTES**
- d. Turn the Rotary Dial until the minutes are set.
- e. Push the Rotary Dial to confirm. Display shows and

- CONFIRMED ✓** and displays **UNIT ON** and the selected time.
- f. Turn the Rotary Dial until the display shows **EXIT** and push the Rotary Dial.
COFFEE READY

26.9 AUTO-OFF

Your Z5 is pre-set to turn itself off 2 hours after last use. You can change the auto-off interval between 1/2 hour and 14 hours or you can set the Z5 not to turn itself off at all.

Recommendations: If you use the machine only in the morning, leave the auto-off as is.

If you use the machine all day long set the auto-off between 3 and 5 hours. This way the machine is always ready and you don't have to turn it on and wait for it to warm up again.

COFFEE READY

- Push and hold the Rotary Dial until you hear a beep and the display shows **FILTER**.
- Turn the dial until the display shows: **OFF AFTER**
- a. Push the Rotary Dial. The display shows **OFF AFTER 2 HRS**
- b. Turn the Rotary Dial until the desired setting appears in the display, e.g. **5 HRS**.
- c. Push the Rotary Dial to confirm. Display shows **CONFIRMED ✓** and shows **OFF AFTER 5 HRS**.
- d. Turn the Rotary Dial until the display shows **EXIT** and push the Rotary Dial.
COFFEE READY

26.10 INFORMATION

COFFEE READY

- Push and hold the Rotary Dial until you hear a beep and the display shows **FILTER**.
- Turn the dial until the display shows: **INFORMATION**.
- a. Push the Rotary Dial **1 ESPRESSO 15 COUNT** (example). It shows how often coffee was prepared with this button.
- b. Turning the Rotary Dial slowly clockwise, the display will show the following additional information:
 - How many cups made with the other buttons: 2 Espresso, 1 Coffee, 2 Coffee, Cappuccino, Special Cup, Milk, Hot Water, Pre-ground.
 - Then it will show the pre-sets for these buttons (volumes in oz. and milk in seconds)
 - Finally it will show how often the programs for decalcifying, cleaning and filter change were used.
- c. Push the Rotary Dial to return to **INFORMATION**.
- d. Turn the Rotary Dial until the display shows **EXIT** and push the Rotary Dial.
COFFEE READY

26.11 RENAMING

This nifty feature lets you rename all eight beverage buttons, the welcome message and the end message. The original pre-sets are stored in the Z5 and you can always restore them.

Let's change the **1 ESPRESSO** name to **CUP OF JOE**.

COFFEE READY

- Push and hold the Rotary Dial until you hear a beep and the display shows **FILTER**.
- Turn the dial until the display shows: **RENAME**

- a. Push the Rotary Dial. **RENAME PRODUCT NAME**. If you turn the dial you can select from **PRODUCT NAME**, **WELCOME MESSAGE**, **END MESSAGE**, **EXIT**.
- b. Select **PRODUCT NAME** and push the dial. **PRODUCT NAME CHANGE**. If you turn the dial you can select from **CHANGE**, **RESET**, **RESET ALL**. Select **CHANGE** and push the dial. **SELECT PRODUCT**.
- c. Push the 1-cup Espresso Button. The alphabet will show in the display. Turn the dial to "**C**" and push the dial, then select the letter "**U**" and push the dial and so on.
Please note: The "blank" space is located after the letter "**Ü**".
- d. When you are finished with the new name select the ✓ symbol and push the Rotary Dial.
- e. The machine will display **CONFIRMED ✓** and returns to **RENAME**. Turn the dial until the display shows **EXIT** and push the dial.
COFFEE READY.

The next time you make coffee and push the 1-cup Espresso Button, the display will show **CUP OF JOE**.

Please note: the maximum length of message is 12 characters including spaces.

Please note: you can reset a single beverage button or you can reset all beverage buttons.

26.12 LANGUAGE SELECTION

You can change the display from English to Spanish, German, French or Dutch

COFFEE READY

- Push and hold the Rotary Dial until you hear a beep and the display shows **FILTER**.

- Turn the dial until the display shows: **LANGUAGE**
- a. Push the Rotary Dial **ENGLISH**.
- b. Turn the Rotary Dial until the desired language is displayed.
- c. Push the Rotary Dial to confirm.
- d. Turn the Rotary Dial until the display shows **EXIT** and push to confirm. The display will show the equivalent of Coffee Ready in the language you selected.

26.13 DISPLAY SETTINGS

This function lets you select the time format: AM / PM or Military Time (24HR Format) and volume: OZ (ounces) or ML (milliliters).

COFFEE READY

- Push and hold the Rotary Dial until you hear a beep and the display shows **FILTER**.
- Turn the dial until the display shows: **SETTINGS**
- a. Push the Rotary Dial. **UNIT**. Turn the dial and select from **UNIT** or **TIME FORMAT**.
- b. Push the Rotary Dial and select the display you like.
- c. Push the Rotary Dial to confirm.
- d. Turn the dial until the display shows **EXIT** and push the dial.
COFFEE READY

27. CARE AND MAINTENANCE MESSAGES

To make sure that your machine is always in the best possible condition the Z5 automatically monitors a series of functions, such as water tank level, used coffee container content, bean container etc. When certain conditions are not met, the Z5 will not let you prepare any beverages.

27.1 FILL WATER TANK

The display shows **WATER TANK FILL** when the water level is low. This prevents the pump from running dry. You cannot brew coffee. Add water and the display will show **COFFEE READY**.

27.2 FILL BEANS

COFFEE READY FILL BEANS.

This message will appear with a few beans left in the bean container. This feature makes sure that you will never produce a cup of coffee with not enough beans. You cannot brew coffee before adding beans (chapter 6.b).

27.3 BEAN COVER MISSING

When the display shows **BEANCOVER MISSING** the Z5 will not brew coffee. For safety reasons the cover must be in place. Make sure the bean cover is in place correctly.

Please note: If you lose or break the bean cover the Z5 cannot be used at all. Contact our customer service department.

27.4 EMPTY COFFEE GROUNDS

Used coffee grounds are collected in the used coffee container (Fig. 2,8). After approx. 16 coffee portions, the display shows **GROUNDS EMPTY** and the Z5 will no longer make any beverages. Lift and pull out the complete drawer assembly carefully, since there is water in it (Fig. 2) **TRAY MISSING**.

Important: Do not turn off or unplug the machine while you are emptying the coffee grounds. Empty the used coffee container and the drawer. Make sure that the grid, tray and use coffee container are all assembled correctly and re-insert.

COFFEE READY

Important: If you pull out the drawer in between, you must empty the used coffee container. The Z5 assumes that the used coffee container will be emptied. If you do not empty the container, used coffee will overflow inside the machine and can cause serious damage to the coffee release mechanism. If the display shows **COFFEE BIN MISSING**, the tray is not attached to the drawer (Fig. 2,9).

Please note: The Z5 does not sense whether or not the used coffee container is inserted (Fig. 2,8). If you forget to insert the used coffee container, ground coffee will be discharged onto the tray inside the machine.

28. TABLET CLEANING PROCESS

When brewing coffee inside the Z5, coffee oils start to accumulate in the brewing chamber and around the internal sieves. The Z5 automatically reminds you after approx. 200 cups of coffee to run a tablet cleaning cycle. This 15 minute procedure is highly effective and will insure proper performance. The display will show **COFFEE READY CLEAN** and the rinse button illuminates.

Please note: You can continue making coffee, however we highly recommend that you clean the machine as described below within the next few days. Please use one white cleaning tablet (enclosed). The machine comes with a pack of 2 tablets.

To re-order cleaning tablets see chapter 34.

Important: Once the cleaning program has started do not interrupt the procedure.

COFFEE READY CLEAN

- Push and hold the rinse button until the display shows **TRAY GROUNDS EMPTY**.

a. Remove and empty the drawer and used coffee container,

TRAY MISSING and replace complete assembly (Fig. 2) .

Important: Even if the drawer and the used coffee container are empty, you still need to remove the drawer for approx. 20 seconds and then replace it. The display shows **PRESS BUTTON**.

b. Place a 12 oz. container under the coffee spouts and an 8 oz. container under the nozzles of the auto-cappuccino system.

c. Push the Rinse Button. The display shows **MACHINE IS CLEANING**. You will hear a beep and after a moment the display shows **ADD TABLET**.

d. Open the Cover Lid then the Ground Coffee Lid and drop in one white cleaning tablet, then close lid (Fig. 13).

e. **PRESS BUTTON**. Push the Rinse Button. The display shows **MACHINE IS CLEANING**. The cleaning program will dispense hot foamy water in intervals through the spouts. After a few minutes the machine beeps and the display shows **TRAY GROUNDS EMPTY**.

f. Lift and remove the drawer. Empty the used coffee container and drawer and replace. The display shows **COFFEE READY**.

Please note: After this cleaning process, remove the powder funnel insert and clean under running water and replace.

Tip: You can run a tablet cleaning cycle at anytime even if the machine does not prompt you. It is possible that very oily coffee beans deposit more oils slowing down the brewing process. An extra tablet cleaning cycle will remove the oil build up.

COFFEE READY

- Push and hold the Rotary Dial until the display shows **FILTER**.
- Turn the dial until the display shows: **MAINTENANCE**
- Push the dial and select **CLEAN UNIT**.
- Push the dial again. **TRAY GROUNDS EMPTY**.
- Continue with steps a. through f. above.

29. DECALCIFYING PROCESS

The machine has an integrated decalcifying program.

This program takes about 50 minutes.

When the display shows **COFFEE READY DESCALE** it is time to decalcify the machine. You can still make coffee. However, it is highly recommended that you decalcify the machine within the next 3 to 4 days.

Please note: If you use the Clearyl water cartridge and the display shows **COFFEE READY DESCALE** then your cartridge function is not activated. Follow the instructions in chapter 23a to program the Clearyl Cartridge function. If the cartridge is in use for several weeks install a new cartridge.

Important: The decalcifying program must not be interrupted.

DECALCIFYING AGENT: Only use our special decalcifying tablets Model # 61848, see chapter 34.

CAUTION: Never use vinegar or any other decalcifying agent. This might damage internal parts of the machine.

CAUTION: Immediately remove any splashes or drops of the decalcifying solution from sensitive surfaces, such as natural stone or wood.

Always wait until the decalcifying solution in the water tank has been used up. Do not fill additional decalcifying solution into the water tank.

- a. Push and hold the rinse button until the display shows **TRAY / GROUNDS EMPTY**.
- b. Remove and empty the drawer and used coffee container **TRAY MISSING** and replace complete assembly (Fig. 2).

Important: Even if the drawer and the used coffee container are empty, you still need to remove the drawer for approx. 20 seconds

and then replace it. The display shows **SOLVENT IN TANK**.

- c. Remove and empty the water tank.
- d. Dissolve 3 of the large square decalcifying tablets in a container with 20 oz. of water (0.6 liters) and pour the solution into the water tank. Replace water tank.
- e. **SOLVENT IN TANK PRESS BUTTON.** Remove the Dual Nozzle System and the Dial Component (Fig. 5a, 5b) and place one container underneath the milk spout. Place another container underneath the Hot Water Spout. Each container should have at least an 8 oz. capacity.
- f. Push the Rinse Button. **MACHINE IS DECALCIFYING.** For approx. 35 minutes the Z5 will pump the decalcifying solution in intervals through the Milk Nozzle, then internally into the drawer, then through the Hot Water Spout and again into the drawer. When the water container is empty the display will show **TRAY / GROUNDS EMPTY**.
- g. Remove the containers. Then remove and empty the drawer and used coffee container and replace complete assembly (Fig. 2).
- h. **WATER TANK FILL.** Remove the water tank, thoroughly rinse it and fill with fresh cold water.
- i. Replace the water tank.
- j. **PRESS BUTTON.** Place one container underneath the Milk Nozzle and one container underneath the Dual Coffee Spouts and the Hot Water Spout. Each container should have at least an 8 oz. capacity.
- k. Push the Rinse Button. **MACHINE IS DECALCIFYING.** For the next few minutes the Z5 will pump the fresh water through the Milk Nozzle, then internally into the drawer and finally through the Hot Water Spout to remove all decalcifying traces.

- l. At the end of the decalcifying cycle the display shows **MACHINE IS HEATING**. After a few seconds the Z5 will automatically run a rinse cycle through the Dual Coffee Spouts. **RINSING**.
- m. **TRAY / GROUNDS EMPTY** Remove the containers and remove and empty the drawer and used coffee container and replace complete assembly (Fig. 2).
COFFEE READY.

Tip: You can run a decalcifying cycle at anytime even if the machine does not prompt you.

COFFEE READY

- Push and hold the Rotary Dial until the display shows **FILTER**.
- Turn the dial until the display shows: **MAINTENANCE**
- Push the dial and select **DECALCIFYING UNIT**.
- Push the dial again. **TRAY GROUNDS EMPTY**.
Continue with step b. through l. above.

30. EMPTYING SYSTEM BEFORE TRANSPORT

This procedure is necessary to prevent water and frost damage in case you intend to transport the machine.

- Turn the machine off with the on/off button on top of the machine. The main power switch is still on.
- Remove the water tank.
- Place a cup underneath the Hot Water Spout and place a cup underneath the Auto Cappuccino System.
- Push and hold the Rinse button until the display shows **SYS EMPTY**. The Z5 will release a bit of water and steam and will turn off automatically.
- Before transport make sure the Water Container and the Bean Container are empty.

Please note: Use the original inside and outside carton for transport, or you can order a custom molded, special service shipping container through our customer service department (\$40).

31. TIPS FOR BETTER COFFEE

Pre-warm cups.

If your cup is pre-warmed, your coffee will stay warm longer, especially when you prepare small cups. Use the hot water spout to pre-warm your cups.

Height adjustable coffee-spout

The closer the coffee spouts are to your cups, the less heat is lost in the air. The crema is more durable if the coffee flows down the inside of the cup, rather than hitting the bottom of the cup.

Old beans

Beans will lose aroma when sitting too long in the bean container. We recommend to fill just enough coffee beans into the bean container for up to three or four days.

32. TROUBLE SHOOTING

A. NO COFFEE COMES OUT OF THE COFFEE SPOUT

Reason: Beans in bean container are not properly feeding into the grinder because they are stuck together.

Solution: Stir beans before grinding. While grinding turn the grinding selector to the coarsest setting (chapter 7).

Reason: You used ground coffee in the Ground Coffee Funnel. The ground coffee was too fine.

Solution: Use ground coffee that is ground somewhat coarser.

Reason: No water is transported through the system.

Solution: Remove water container and make sure that the connecting valve is free of any particles (like a coffee bean etc).

Reason: The ground coffee funnel or the internal brewing chamber is clogged.

Solution: Place a cup underneath the Dual Coffee Spout and run an extra rinse cycle.

COFFEE READY

- Push and hold the Rotary Dial until display shows **FILTER**.
- Turn the dial until the display shows: **MAINTENANCE**
- Push the dial and select **RINSE UNIT**.
- Push the Rotary Dial again. Place a cup underneath the Dual Coffee Spouts and push the Rinse Button.

COFFEE READY

B. THE DISPLAY READS FILL WATER BUT THERE IS ENOUGH WATER IN THE WATER TANK.

Reason: The low water floatation device (Fig. 10 "x") is missing.

Solution: Within the water tank is a small compartment. Inside is a small black floatation device. On top is a small clear plastic cover. This small plastic cover is missing and the floatation device is outside of the small compartment. Check if you can locate both pieces and reassemble. If you cannot find them, call 1-800-220-5701. We will send the pieces to you FREE OF CHARGE.

C. INSUFFICIENT FROTHED MILK PRODUCTION

Make sure

- the dial of the Auto Cappuccino System points the frothing position (Fig. 5f).
- the venting tip (Fig. 5a) is clean (check if the flexible lip is free of any old milk residue).
- the Auto Cappuccino System is assembled tightly (chapter 12)
- all parts of the Auto Cappuccino System are clean and not clogged with old milk residue

The milk you are using is "too heavy". "Half and Half" or liquid coffee creamers like "coffemate" are too heavy to be siphoned fast enough through the system.

Skim milk will always produce more froth than whole milk.

D. GRINDER MAKES AN EXTREMELY LOUD NOISE; NO BEANS ARE GROUND

Reason: A stone is blocking the burr grinder.

- Turn the machine off. Unplug the machine.
- Open the Cover Lid and remove the Bean Container Safety Lid (Fig. 4).
- Remove any beans with a vacuum hose.
- Attach the burr grinder release tool (Welcome Pack) to the upper burr (Fig. 15).
- If you cannot find the tool, call customer service 1-800-220-5701 and we will send the tool free of charge.
- Turn the tool slowly counter-clock wise until the stone is released.
- Fill with a few beans.
- Turn the machine on and test the grinder.
- Discard the first two cups of coffee.

33. ERROR MESSAGES

If the Z5 displays any of the following error messages, please proceed as described.

ERROR 1, ERROR 3, ERROR 4, ERROR 5

Call our customer service hot line 1-800-220-5701.

Your machine needs to be returned for service.

ERROR 2

Your machine is too cold. The heating sensor does not react.

- Turn the machine off.
- Keep the machine at normal room temperature (65° F or higher) for 2 hours .
- Then turn it on again.

If display still shows **ERROR 2**, call customer service.

ERROR 6, ERROR 7, ERROR 8

- Turn machine off, turn the main power switch off and unplug machine for a minute.
- Turn machine on again. If the error message comes up again, try one more time.
- If the message persists, call customer service.

34. MAINTENANCE SUPPLIES

The following supplies are necessary to keep your machine in good working order:

- **Clearyl Water Filter Cartridge** (one included)
Model #64553; the machine will remind you automatically.
Tip: If you brew 10 cups a day you need about one Clearyl cartridge per month. Always keep extra cartridges available.
- **Special Cleaning Tablets** (two included) Model #62205
Tip: If you brew 10 cups a day you need about one tablet every 3 weeks. Always keep extra tablets available.
- **Auto-Cappuccino Cleaner** (one bottle included)
Model #63801
Tip: If you use the auto cappuccino cleaner once a day you need a new bottle every 2 1/2 weeks. Always keep extra bottles available.

- **Decalcifying tablets** (large square tablets) - Model #61848
Please note: You must use decalcifying tablets if you do not use the Clearyl cartridge.

You can order these supplies:

- with the enclosed mail order form or
- through our website www.cappresso.com or
- by calling our customer service center at 1-800-220-5701.

35. LIMITED WARRANTY

Please note: This warranty will be void if the Warranty / Product Registration has not been received two weeks after the purchase date (you can fax or mail the registration or you can register through our website www.cappresso.com)

This limited warranty covers your new IMPRESSA Z Series. For Home and Commercial Use: One Year or 6,000 coffee brewings, whichever comes first.

This warranty is in effect for the period and usage described above from the date of the first purchase and is limited to the United States of America. This warranty covers all defects in materials or workmanship (parts and labor) including free UPS ground transportation for both ways within the continental United States. For Hawaii and Alaska freight is not covered by this warranty.

TRANSPORT: When sending the Z5, use the original packing materials, the inner and outer cartons or you can order a special custom molded service shipping container through our customer service department (\$40). If you ship the machine in other packaging any damage in transit is NOT covered by this warranty.

This warranty does not cover:

- Any machine NOT distributed by JURA-CAPRESSO within the United States.
- Any machine not purchased from an Authorized Dealer.
- Damage caused by accident, abuse, negligence, misuse, improper operation or failure to follow instructions contained in this manual.
- Any service or alteration performed by an unauthorized person, company or association.
- Damage caused by neglecting and omitting maintenance, cleaning and decalcifying cycles.
- Damage caused by use of instant coffee or any other ingredients not allowed in this product.

Other limitations and exclusions:

Any implied warranties including fitness for use and merchantability are limited in duration to the period of the express warranty set forth above and no person is authorized to assume for JURA-CAPRESSO any other liability in connection with the sale of the machine. JURA-CAPRESSO expressly disclaims liability for incidental and consequential damages caused by the machine. The terms "incidental damages" refer to the loss of the original purchaser's time, loss of the use of the machine or other costs relating to the care and custody of the machine. The terms "consequential damages" refer to the cost of repairing or replacing other property which is damaged when this machine does not work properly. Any loss of income is excluded. The remedies provided under this warranty are exclusive and in lieu of all others. This warranty gives you specific legal rights, and you may also have other rights which vary from state to state.

Jura-Capresso, LLC

81 Ruckman Road, Closter, NJ 07624

201-767-3999 • Fax: 201-767-9684

Customer Service: 1-800-220-5701

Email: contact@capresso.com • Website: www.capresso.com

Free Manuals Download Website

<http://myh66.com>

<http://usermanuals.us>

<http://www.somanuals.com>

<http://www.4manuals.cc>

<http://www.manual-lib.com>

<http://www.404manual.com>

<http://www.luxmanual.com>

<http://aubethermostatmanual.com>

Golf course search by state

<http://golfingnear.com>

Email search by domain

<http://emailbydomain.com>

Auto manuals search

<http://auto.somanuals.com>

TV manuals search

<http://tv.somanuals.com>