



Models 58PAP and 58RAP Induced-Combustion Furnaces

NOTE TO INSTALLER:

This manual must be left with the equipment user.

WARNING: If the information in this manual is not followed exactly, a fire or explosion may result causing property damage, personal injury or loss of life.

- Do not store or use gasoline or other flammable vapors and liquids in the vicinity of this or any other appliance.
- **WHAT TO DO IF YOU SMELL GAS:**
 - Do not try to light any appliance.
 - Do not touch any electrical switch; do not use any phone in your building.
 - Immediately call your gas supplier from a neighbor's phone. Follow the gas supplier's instructions.
 - If you cannot reach your gas supplier, call the fire department.
- Installation and service must be performed by a qualified installer, service agency or the gas supplier.

USER'S INFORMATION MANUAL FOR THE OPERATION AND MAINTENANCE OF YOUR NEW GAS-FIRED FURNACE

GAS FURNACES

WELCOME TO A NEW GENERATION OF COMFORT

Congratulations! Your new, 78% efficient gas furnace is a sound investment which will reward you and your family with years of warm memories winter after winter.

Not only is your new furnace energy efficient, it is also extremely reliable. Spend just a few minutes with this booklet to learn about the operation of your new furnace—and the small amount of maintenance it takes to keep it operating at peak efficiency. Years went into the development of your new furnace. Take a little time now to assure its most efficient operation for years to come.

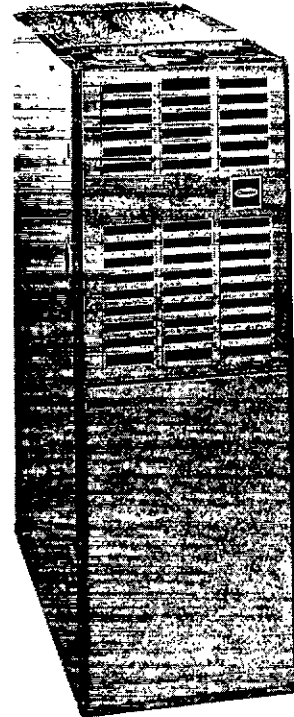

1

A90110

MODEL 58PAP UPFLOW FURNACE

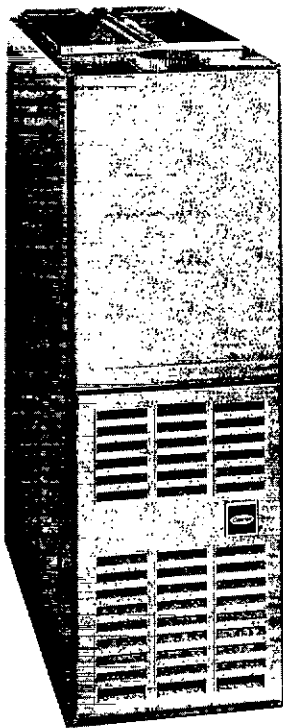

A90109

2

MODEL 58RAP DOWNFLOW FURNACE

FURNACE IDENTIFICATION

For your convenience, record the product and serial numbers of your new furnace on the form below. Should you ever require service, you will have ready access to the information needed by the service representative.

Product No. _____

Serial No. _____

Date Installed _____

Dealer Name _____

Address _____

City _____

State _____ Zip _____

Telephone _____

IMPORTANT! IMPORTANT!

Please Fill Out And Return Within The Next 10 Days.

1. Mr. 2. Mrs. 3. Ms. 4. Miss
 First Name _____ Initial _____ Last Name _____
 Street _____ Apt. No. _____
 City _____ State _____ ZIP Code _____

④ Date of Installation: _____
 Month _____ Day _____ Year _____

④ Date of birth of person whose name appears above: _____
 Month _____ Year _____

⑤ Important! For proper registration, please fill in the model number, and serial number of this product:

A. Model Number: _____

B. Serial Number: _____

⑥ What type of product is this?

- 1. Central Air Conditioner
- 2. Gas Furnace
- 3. Oil Furnace
- 4. Electric Furnace
- 5. Heat Pump

⑥ Excluding yourself, what is the SEX and AGE (in years) of children and other adults living in your household?

1. No one else in household

Male	Female	Age	Male	Female	Age
1. <input type="checkbox"/>	2. <input type="checkbox"/>	_____ years	1. <input type="checkbox"/>	2. <input type="checkbox"/>	_____ years
1. <input type="checkbox"/>	2. <input type="checkbox"/>	_____ years	1. <input type="checkbox"/>	2. <input type="checkbox"/>	_____ years

⑦ A. Price paid for this product (excluding installation charges and sales tax):

\$ _____ .00

B. Price paid for installation:

\$ _____ .00

⑥ Marital Status:

- 1. Married
- 2. Divorced/Separated
- 3. Widowed
- 4. Never Married (Single)

⑥ Occupation:

	You	Spouse
Homemaker	<input type="checkbox"/>	1. <input type="checkbox"/>
Professional/Technical	<input type="checkbox"/>	2. <input type="checkbox"/>
Upper Management/Executive	<input type="checkbox"/>	3. <input type="checkbox"/>
Middle Management	<input type="checkbox"/>	4. <input type="checkbox"/>
Sales/Marketing	<input type="checkbox"/>	5. <input type="checkbox"/>
Clerical or Service Worker	<input type="checkbox"/>	6. <input type="checkbox"/>
Tradesman/Machine Oper./Laborer	<input type="checkbox"/>	7. <input type="checkbox"/>
Retired	<input type="checkbox"/>	8. <input type="checkbox"/>
Student	<input type="checkbox"/>	9. <input type="checkbox"/>
Self Employed/Business Owner	<input type="checkbox"/>	10. <input type="checkbox"/>

⑥ Name of company that sold you this product:

⑥ When did you acquire your product?

- 1. Upon purchase of a new dwelling.
- 2. To replace an older system of the same brand.
- 3. To replace an older system of another brand.
- 4. Within a year after purchasing a dwelling with no central air.
- 5. 2-4 years after buying a dwelling with no central air system.
- 6. Over 4 years after buying a dwelling with no central air system.

⑥ Which group describes your annual family income?

- 1. Under \$15,000
- 2. \$15,000-\$19,999
- 3. \$20,000-\$24,999
- 4. \$25,000-\$29,999
- 5. \$30,000-\$34,999
- 6. \$35,000-\$39,999
- 7. \$40,000-\$44,999
- 8. \$45,000-\$49,999
- 9. \$50,000-\$59,999
- 10. \$60,000-\$74,999
- 11. \$75,000-\$99,999
- 12. \$100,000 & over

⑥ If you replaced an older system, approximately how old was that system?

- 1. Don't know
- 2. 1-5 years
- 3. 6-8 years
- 4. 9-11 years
- 5. 12-14 years
- 6. 15-17 years
- 7. 18-20 years
- 8. 21-24 years
- 9. Over 24 years

⑥ Education: (please check those which apply)

	You	Spouse
Some High School or Less	<input type="checkbox"/>	1. <input type="checkbox"/>
Completed High School	<input type="checkbox"/>	2. <input type="checkbox"/>
Vocational/Technical School	<input type="checkbox"/>	3. <input type="checkbox"/>
Some College	<input type="checkbox"/>	4. <input type="checkbox"/>
Completed College	<input type="checkbox"/>	5. <input type="checkbox"/>
Some Graduate School	<input type="checkbox"/>	6. <input type="checkbox"/>
Completed Graduate School	<input type="checkbox"/>	7. <input type="checkbox"/>

⑥ If this is a replacement, what brand did you previously own?

- 1. Amana
- 2. Bryant
- 3. Carrier
- 4. Day & Night
- 5. Heil
- 6. Janitrol
- 7. Lennox
- 8. Payne
- 9. Rheem
- 10. Ruud
- 11. Snyder
- 12. Tempstar
- 13. Trane
- 14. York
- 15. Other _____

⑥ Which credit cards do you use regularly?

- 1. American Express, Diners Club
- 2. MasterCard, Visa, Discover
- 3. Department Store, Oil Company, etc.
- 4. Do not use credit cards

⑥ What factors most influenced your selection of this product? (Check a maximum of two.)

- 1. Brand reputation
- 2. Dealer reputation
- 3. Previous experience with products of this brand
- 4. Previous experience with this dealer
- 5. Price
- 6. Energy efficiency
- 7. Location of dealer
- 8. Dealer's installation policy
- 9. Friend's/relative's recommendation
- 10. Contractor's/dealer's recommendation
- 11. Other _____

⑥ For your primary residence, do you:

- 1. Own a House?
- 2. Own a Townhouse or Condominium?
- 3. Rent a House?
- 4. Rent an Apartment, Townhouse or Condominium?

⑥ To help us understand our customers' lifestyles, please indicate the interests and activities in which you or your spouse enjoy participating on a regular basis:

- | | | |
|--|---|---|
| <input type="checkbox"/> 01. Bicycling Frequently | <input type="checkbox"/> 14. Needlework/Knitting | <input type="checkbox"/> 27. Health/Natural Foods |
| <input type="checkbox"/> 02. Golf | <input type="checkbox"/> 15. Vegetable Gardening | <input type="checkbox"/> 28. Photography |
| <input type="checkbox"/> 03. Physical Fitness/Exercise | <input type="checkbox"/> 16. Flower Gardening | <input type="checkbox"/> 29. Home Furnishing/Decorating |
| <input type="checkbox"/> 04. Running/Jogging | <input type="checkbox"/> 17. Sewing | <input type="checkbox"/> 30. Attending Cultural/Arts Events |
| <input type="checkbox"/> 05. Snow Skiing Frequently | <input type="checkbox"/> 18. Crafts | <input type="checkbox"/> 31. Fashion Clothing |
| <input type="checkbox"/> 06. Tennis Frequently | <input type="checkbox"/> 19. Automotive Work | <input type="checkbox"/> 32. Fine Art/Antiques |
| <input type="checkbox"/> 07. Camping/Hiking | <input type="checkbox"/> 20. Electronics | <input type="checkbox"/> 33. Foreign Travel |
| <input type="checkbox"/> 08. Fishing Frequently | <input type="checkbox"/> 21. Home Workshop/Do It Yourself | <input type="checkbox"/> 34. Travel in the USA |
| <input type="checkbox"/> 09. Hunting/Shooting | <input type="checkbox"/> 22. Recreational Vehicles | <input type="checkbox"/> 35. Gourmet Cooking |
| <input type="checkbox"/> 10. Power Boating | <input type="checkbox"/> 23. Stereo, Records/Tapes/CDs | <input type="checkbox"/> 36. Wines |
| <input type="checkbox"/> 11. Sailing | <input type="checkbox"/> 24. Buy Pre-Recorded Videos | <input type="checkbox"/> 37. Coin/Stamp Collecting |
| <input type="checkbox"/> 12. House Plants | <input type="checkbox"/> 25. Avid Book Reading | <input type="checkbox"/> 38. Collectibles/Collections |
| <input type="checkbox"/> 13. Grandchildren | <input type="checkbox"/> 26. Bible/Devotional Reading | <input type="checkbox"/> 39. Our Nation's Heritage |
| | | <input type="checkbox"/> 40. Real Estate Investments |
| | | <input type="checkbox"/> 41. Stock/Bond Investments |
| | | <input type="checkbox"/> 42. Entering Sweepstakes |
| | | <input type="checkbox"/> 43. Casino Gambling |
| | | <input type="checkbox"/> 44. Science Fiction |
| | | <input type="checkbox"/> 45. Wildlife/Environmental Issues |
| | | <input type="checkbox"/> 46. Dieting/Weight Control |
| | | <input type="checkbox"/> 47. Science/New Technology |
| | | <input type="checkbox"/> 48. Self Improvement |
| | | <input type="checkbox"/> 49. Walking for Health |
| | | <input type="checkbox"/> 50. Watching Sports on TV |

⑥ Using the numbers in the above list, please indicate the 3 most important activities for:

You _____

Spouse _____

⑥ Please check all that apply to your household:

- 1. Regularly Purchase Items Through the Mail
- 2. Military Veteran in Household
- 3. Member of Frequent Flyer Program
- 4. Support Health Charities
- 5. Subscribe to Cable TV
- 6. Have a Microwave Oven
- 7. Have a CD Player
- 8. Have a VCR
- 9. Use a Personal Computer
- 10. Have a Dog
- 11. Have a Cat

Thanks for taking the time to fill out this questionnaire. Your answers will be used for market research studies and reports — and will help us better serve you in the future. They will also allow you to receive important mailings and special offers from a number of fine companies whose products and services relate directly to the specific interests, hobbies, and other information indicated above. Through this selective program, you will be able to obtain more information about activities in which you are involved and less about those in which you are not. Please check here if, for some reason, you would prefer not to participate in this opportunity.

If you have comments or suggestions about our product please write to:

Carrier
 Consumer Relations Department
 P.O. Box 4808
 Syracuse, NY 13221
 or call 1-800-C-A-R-R-I-E-R

STAPLE OR TAPE HERE

FOLD HERE

Please send products and other correspondence to:

Carrier
Consumer Relations Department
P.O. Box 4808
Syracuse, NY 13221

PLACE
FIRST-CLASS
STAMP
HERE



**P O BOX 173244
DENVER CO 80217-3244**

UPFLOW FURNACE COMPONENTS

- 1 Relief Box
- 2 Gas Valve Control Knob (On, Pilot, Off)
- 3 Gas Valve
- 4 Gas Burner
- 5 Pilot Burner and Thermocouple
- 6 Blower Door Safety Switch
- 7 Blower and Blower Motor
- 8 Draft Safeguard Tube and Switch
- 9 Rating Plate (Behind Junction Box)
- 10 Gas Manifold
- 11 Filter Retainer
- 12 Air Filter

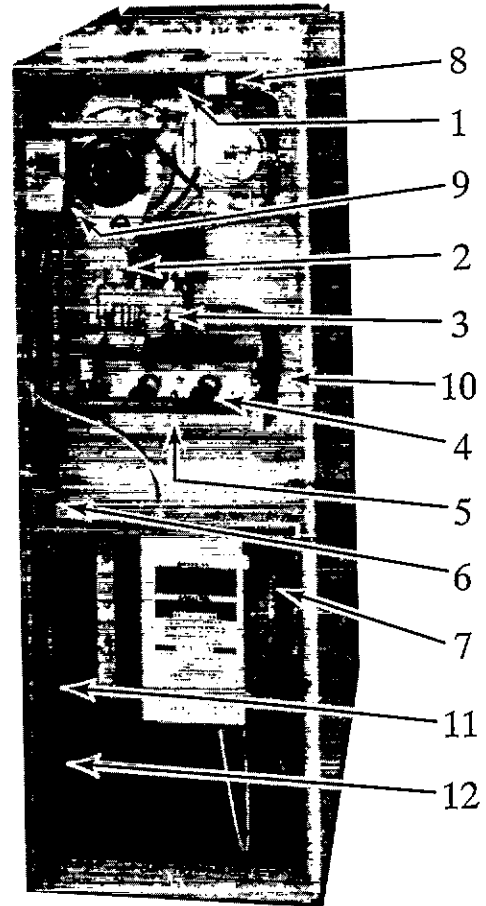

A92180

3

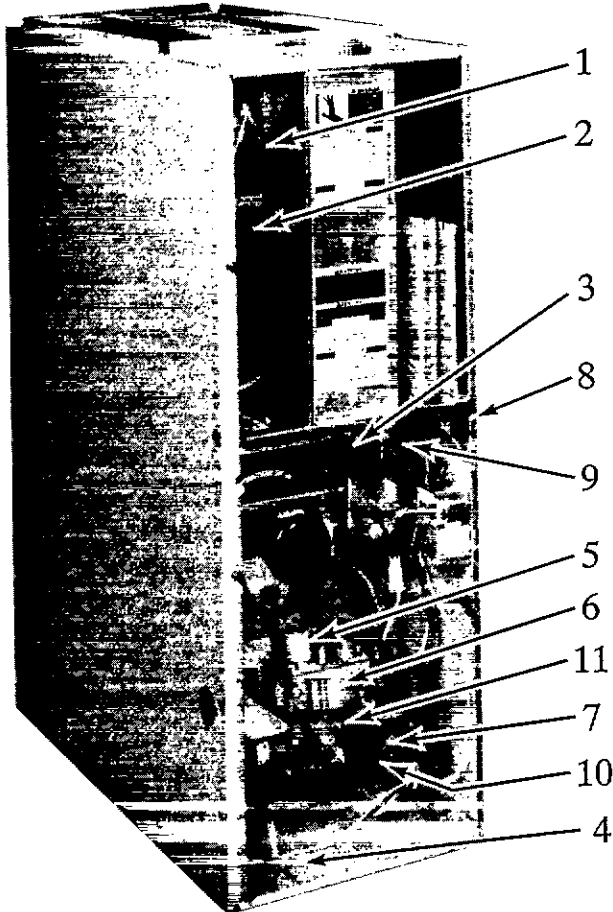

DOWNFLOW FURNACE COMPONENTS

- 1 Manual-Reset Auxiliary Limit Switch (Behind Enclosure)
- 2 Blower and Blower Motor
- 3 Relief Box
- 4 Rating Plate
- 5 Gas Valve Control Knob (On, Pilot, Off)
- 6 Gas Valve
- 7 Gas Burner
- 8 Blower Door Safety Switch
- 9 Draft Safeguard Tube and Switch
- 10 Gas Manifold
- 11 Pilot Burner and Thermocouple

A92181

4

3

IMPORTANT FACTS

Your furnace must have adequate airflow for efficient combustion and safe ventilation. Do not enclose it in an airtight room or "seal" it behind solid doors. To minimize the possibility of serious personal injury, fire, damage to your furnace, or improper operation, **carefully follow these safety rules:**

- Keep the area around your furnace free of combustible materials, gasoline, and other flammable liquids and vapors.
- Do not cover the furnace, store trash or debris near it, or in any way block the flow of fresh air to the unit.
- Combustion air must be clean and uncontaminated with chlorine or fluorine. These compounds are present in many products around the home, such as: water softener salts, laundry bleaches, detergents, adhesives, paints, varnishes, paint strippers, waxes, and plastics.

Make sure the combustion air for your furnace does not contain any of these compounds. During remodeling be sure the combustion air is fresh and uncontaminated. If these compounds are burned in your furnace, the heat exchangers and metal vent system may deteriorate.

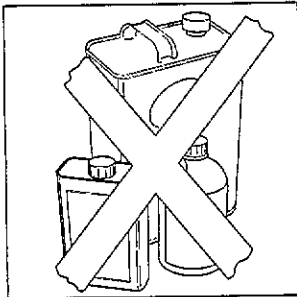

A92182

5

- A furnace installed in the attic or other insulated space must be kept free and clear of the insulating material. Examine the furnace area when installing the furnace or adding more insulation. Some materials may be combustible.

NOTE: Do not use this furnace if any part has been under water. Immediately call a qualified service technician to inspect the furnace and to replace any part of the control system and any gas control which has been under water.

NOTE: The qualified installer or agency must use only factory-authorized replacement parts, kits, and accessories when modifying or repairing this product.

This furnace contains SAFETY DEVICES which must be closed. If the furnace is left unattended for an extended period of time, have it checked periodically for proper operation. This precaution will prevent problems associated with NO HEAT, such as frozen water pipes, etc. See "Before You Request a Service Call" section in this manual.

SAFETY CONSIDERATIONS

Installing and servicing heating equipment can be hazardous due to gas and electrical components. Only trained and qualified personnel should install, repair, or service heating equipment.

Untrained personnel can perform basic maintenance functions such as cleaning and replacing air filters. All other operations must be performed by trained service personnel. Observe safety precautions in this manual, on tags, and labels attached to the furnace and other safety precautions that may apply.

Recognize safety information: This is the safety-alert symbol \triangle . When you see this symbol on the furnace and in instructions or manuals, be alert to the potential for personal injury.

Understand the signal word—DANGER, WARNING, or CAUTION. These words are used with the safety-alert symbol. DANGER identifies the most serious hazards which **will** result in severe personal injury or death. WARNING signifies hazards that **could** result in personal injury or death. CAUTION is used to identify unsafe practices, which **would** result in minor personal injury or product and property damage.

STARTING YOUR FURNACE

Your furnace is equipped with a continuously burning pilot flame.

- This manual ignition system requires the pilot to be match-lit by hand.
- Read and follow the operating instructions on the furnace, especially the item that reads as follows:
Wait 5 minutes to clear out any gas. Then smell for gas, including near the floor. If you smell gas, **STOP!** Follow "B" in the safety information above on this label. If you don't smell gas, go to the next step.
- If a suspected malfunction occurs with your gas control system, such as the pilot not lighting when it should, refer to the shutdown procedures on the furnace or in the next section to turn off your system, then call your service dealer as soon as possible.

\triangle WARNING

Should overheating occur, or the gas valve fail to shut off the gas supply, turn off the external manual gas valve to the furnace **BEFORE** turning off the electrical supply. (See Fig. 7.) A failure to follow this warning could result in a fire or explosion, and personal injury or death.

- **CHECK AIR FILTER:** Before attempting to start your furnace, be sure the furnace filter is clean and in place. (See the maintenance section of this manual.) Then proceed as follows:

STEPS FOR STARTING YOUR FURNACE

Refer to the lighting instruction label affixed to the furnace blower access door.

1. Set your room thermostat to the lowest temperature setting. (See Fig. 6.)
2. Close the external manual gas valve. (See Fig. 7.)
3. Turn **OFF** the electrical supply to your furnace. (See Fig. 8.)

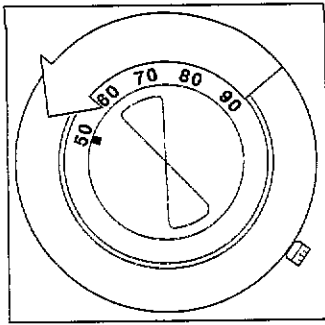

A92184

6

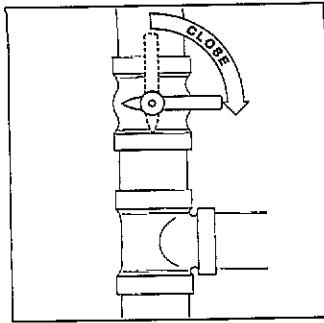

A92183

7

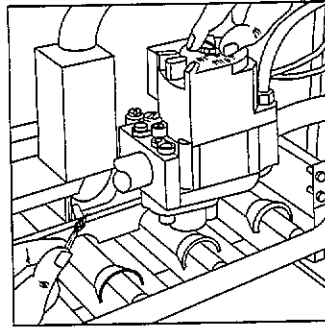

A91403

13

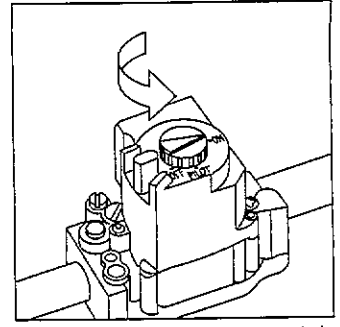

A91404

14

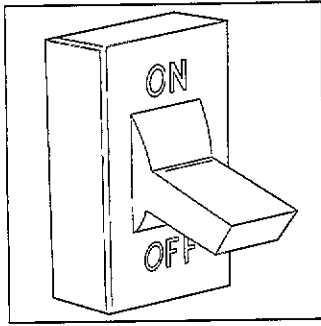

A92185

8

4. Remove the furnace access door(s).

- a. Upflow—remove control door. (See Fig. 9.)
- b. Downflow—remove blower door after removing 2 screws first, then remove the control door. (See Fig. 10.) Reinstall the blower door.

NOTE: The blower door must be installed to permit furnace operation.

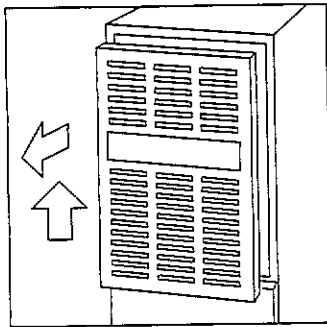

A91400

9

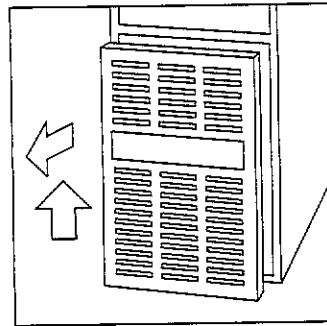

A91401

10

5. Turn the control knob on the internal gas valve clockwise to the indicated OFF position. Wait 5 minutes for any expelled gas to dissipate. (See Fig. 11.)
6. After waiting 5 minutes, open the external manual gas valve. (See Fig. 12.)

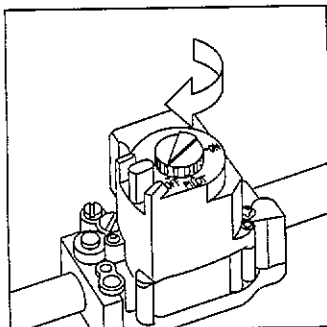

A91402

11

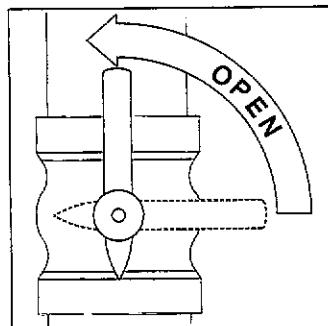

A92186

12

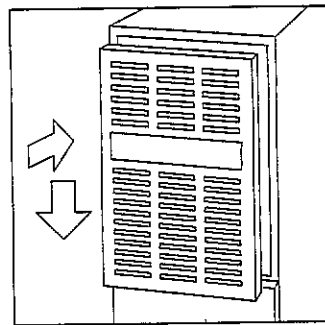

A91405

15

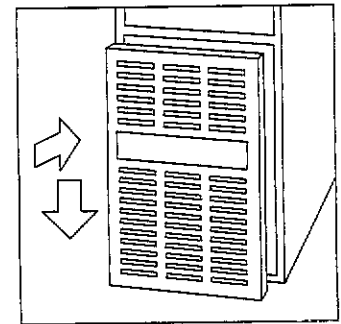

A91406

16

7. Turn the control knob on the internal gas valve to the PILOT position.
 8. Place a lighted match or other suitable source of flame near the top of the pilot. (See Fig. 13.)
 9. Depress the button or knob and hold it down. The pilot will light. Remove and extinguish the match while continuing to hold the button or knob down for at least 60 sec, then release. The pilot will remain lit.
- NOTE:** If pilot does not stay lit, repeat steps 5 through 9; however, hold the button down for a longer period of time (at least 90 sec). If the pilot flame is extinguished after this second attempt, the thermocouple should be checked for a possible malfunction. Call your dealer for service.
10. After the pilot flame is established, turn the control knob on the gas valve to the ON position.
 11. Replace the access door. (See Fig. 15 or 16.) For downflow furnaces, remove the blower access door, install the control access door, then reinstall the blower access door and secure with 2 screws.
 12. Turn on the electrical supply to the furnace.
 13. Adjust the room thermostat to a setting slightly above room temperature. This will automatically signal the furnace to start.
 14. Furnace main burners should light shortly after you set the thermostat. After you verify that the burners are lit, you may adjust the room thermostat to your own personal comfort setting. If the burners fail to light, shut down your furnace and call your dealer for service. Refer to the lighting instruction label affixed to your furnace blower access door or page 8 for shutdown procedures.

NOTE: To conserve energy when the heating season has ended, you should shut down your manually ignited pilot. Follow the procedures in the "Shutting Down Your Furnace" section of this manual.

SUGGESTION: Setting the thermostat back a few degrees—and compensating for the difference with warmer clothing—can make a big difference in your fuel consumption on extremely cold days. The few degrees at the top of your thermostat "comfort level" are the most costly degrees to obtain.

When the room temperature drops below the temperature selected on the thermostat, the furnace will be switched on automatically. When the room temperature reaches the degree selected on the thermostat, the furnace will be automatically switched off.

Some thermostats have a "fan" switch with 2 selections: AUTO or ON. When set on AUTO, the furnace blower cycles on and off, controlled by the thermostat. In the ON position, the furnace blower runs continuously except for a 45-sec delay at the "call for heat." This keeps the temperature level in your home more evenly balanced. It also continuously filters the indoor air.

SHUTTING DOWN YOUR FURNACE

Once the heating season has ended, or if you ever suspect a malfunction, you'll want to turn your furnace off. The following procedures and the procedures on the lighting/operating instructions label on your furnace must be followed:

1. Set your room thermostat to the lowest temperature setting. (See Fig. 17.)
2. Turn OFF the electrical supply to your furnace. (See Fig. 18.)

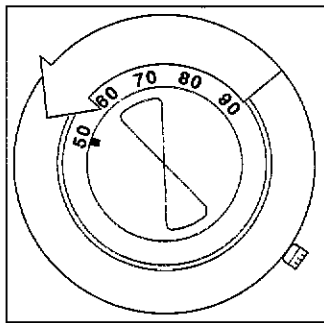

A92184

17

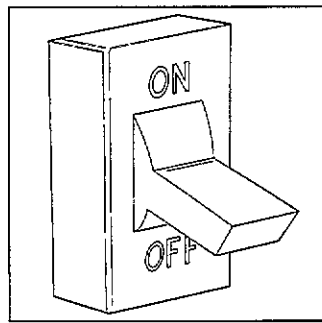

A92185

18

3. Remove the access door(s) from your furnace. Lift up and out at the bottom. (See Fig. 9 for upflow and Fig. 10 for downflow furnaces.)

NOTE: The blower access door must be installed to permit furnace operation.

4. To shut off the burners but keep the pilot light burning, turn the control knob of the internal gas valve to the PILOT position.
5. To shut off the complete gas control system (pilot and burners), turn (and depress if required) the control knob on the internal gas valve clockwise to the indicated OFF position.
6. Close the external manual gas valve. (See Fig. 7.)
7. Replace the access door. (See Fig. 15 or 16.) On downflow furnaces, remove the blower access door, install the control access door, then reinstall the blower access door and secure with 2 screws.
8. If the furnace is being shut down because a malfunction is suspected, call your service dealer as soon as possible.

NOTE: To conserve energy when the heating season has ended, you should shut down your manually ignited pilot.

If the furnace blower is to be used during the cooling season, turn the control knob on the internal gas valve to OFF. Leave the electrical supply to the furnace turned ON.

PERFORMING ROUTINE MAINTENANCE

With the proper maintenance and care, your furnace will operate economically and dependably. Basic maintenance, which can easily be accomplished by following the directions, is found

on this and the following pages. However, before beginning maintenance, follow these safety precautions:

▲ WARNING

TURN OFF ELECTRICAL POWER SUPPLY TO YOUR FURNACE BEFORE REMOVING THE ACCESS DOORS TO SERVICE OR PERFORM MAINTENANCE. A FAILURE TO FOLLOW THIS WARNING COULD RESULT IN PERSONAL INJURY OR DEATH.

▲ CAUTION

ALTHOUGH SPECIAL CARE HAS BEEN TAKEN TO MINIMIZE SHARP EDGES, BE EXTREMELY CAREFUL WHEN HANDLING PARTS OR REACHING INTO THE FURNACE.

FILTERING OUT TROUBLE

A dirty filter will cause excessive stress on the furnace blower motor and can cause it to overheat and automatically shut down. The furnace filter should be checked every 3 or 4 weeks and cleaned if necessary.

If your furnace filter needs replacing, be sure to use the same size and type of filter that was originally supplied. Use the furnace filter table (see page 7) and compare your furnace size with the proper filter size.

▲ CAUTION

NEVER OPERATE YOUR FURNACE WITHOUT A FILTER IN PLACE.

Doing so may damage the furnace blower motor. An accumulation of dust and lint on internal parts of your furnace can cause a loss of efficiency.

The air filter for upflow furnaces is normally located in the blower compartment. Filters for the downflow furnaces are normally located in the return-air plenum above the blower. If the filters have been installed in another location, contact your dealer for instructions. To inspect, clean and/or replace the air filter(s), follow these steps:

● UPFLOW FURNACES ONLY:

1. Turn OFF the electrical supply to the furnace. (See Fig. 18.)
2. Remove control and blower access doors.
3. Push filter retainer toward the bracket opening to release the filter. (See Fig. 19.)
4. Gently remove the filter and carefully turn the dirty side up (if dirty) to avoid "spilling" dirt from the filter. (See Fig. 20.)

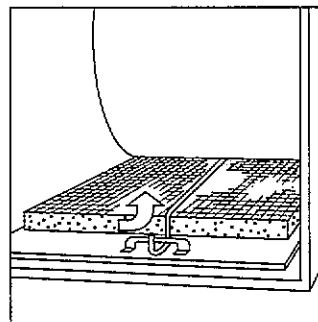

A91407

19

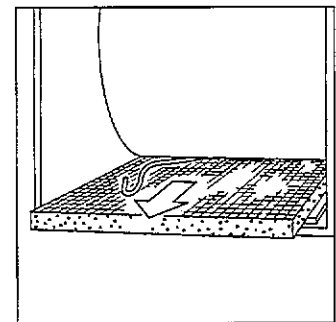

A91408

20

5. Inspect the filter. If torn, replace the filter.
6. Wash the filter (if dirty) in a sink, bathtub, or outside with a garden hose. Always use cold tap water. A mild liquid detergent may be used if necessary. Spray water through the filter in the opposite direction of airflow (through the cross-mesh binding side). Allow filter to dry.
7. Reinstall the clean filter with its cross-mesh binding side facing the furnace blower.
8. Put filter retainer back in the bracket opening and lock it in place.
9. Replace the blower and control access doors and turn ON electrical power to your furnace. (See Fig. 15, 16, and 21.)

NOTE: If side return ducts are used, two filters may be required in some models. The procedure listed above may be used to remove side filters.

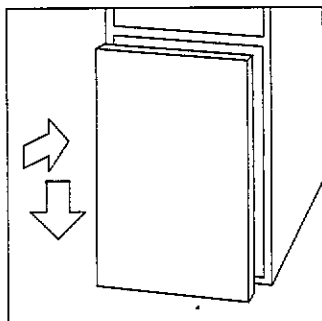

A91409

21

• **DOWNFLOW FURNACES ONLY:**

Two filters are located in the return-air plenum above the blower (above line-of-sight) resting in the V-shaped channel on top of the furnace. (See Fig. 22.)

1. Turn OFF electrical supply to the furnace. (See Fig. 18.)
2. Remove blower access door after removing 2 screws.
3. Remove left side filter by tipping the filter top toward the center—raise it from the V-shaped channel in which it rests. (See Fig. 22 and 23.)

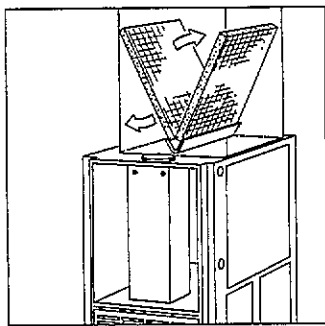

A91410

22

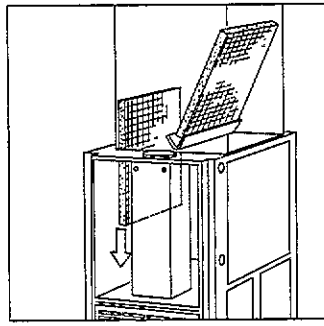

A91411

23

4. Lower filter down along side of the blower and remove from the furnace.
5. To remove the second filter, lift from V-shaped channel and remove the same way as left side filter.
6. Inspect the filters. If torn, replace the filter.
7. Wash the filters (if dirty) in a sink, bathtub, or outside with a garden hose. Always use cold tap water. A mild liquid detergent may be used if necessary. Spray water through the filter in the opposite direction of airflow through the cross-mesh binding side. Allow filter to dry.
8. Reinstall clean filters with the cross-mesh binding side facing the furnace blower.

9. Replace blower door (secure with 2 screws) and turn ON electrical power to your furnace.

UPFLOW FURNACE FILTER TABLE

FURNACE CASING WIDTH	FILTER SIZE		FILTER TYPE
	Side Return	Bottom Return	
14-3/16	(1) 16 x 25 x 1*	(1) 14 x 25 x 1	Cleanable
17-1/2	(1) 16 x 25 x 1*	(1) 16 x 25 x 1	Cleanable
21	(1) 16 x 25 x 1	(1) 20 x 25 x 1*	Cleanable
24-1/2	(2) 16 x 25 x 1	(1) 24 x 25 x 1*	Cleanable

DOWNFLOW FURNACE FILTER TABLE

FURNACE CASING WIDTH	FILTER SIZE	FILTER TYPE
14-3/16	(2) 16 x 20 x 1*	Cleanable
17-1/2	(2) 16 x 20 x 1*	Cleanable
21	(2) 16 x 20 x 1*	Cleanable
24-1/2	(2) 16 x 20 x 1*	Cleanable

*Factory provided with the furnace. Filter may be field modified by cutting as required. Alternate sizes and additional filters may be ordered from your dealer.

COMBUSTION AREA AND VENT SYSTEM

Inspect the combustion area and vent system before each heating season. An accumulation of dirt, soot, or rust can mean a loss of efficiency and improper performance. Buildups on the main burners or pilot assembly can cause faulty firing. This "delayed ignition" is characterized by an alarmingly loud sound. If your furnace makes a loud noise when the main burners are ignited by the pilot, shut down the furnace—call your servicing dealer. Refer to the lighting instructions label on the blower door for shutdown procedures.

Use your flashlight and follow these steps for inspecting the combustion area and vent system of your furnace:

1. Turn off the electrical supply to the furnace and remove the access doors. (See Fig. 8 and 9, or 10.)
2. Carefully inspect the gas burner (see Fig. 24) for dirt, rust, or scale. Then, inspect the relief box, flue connection area, and the vent pipe for rust.

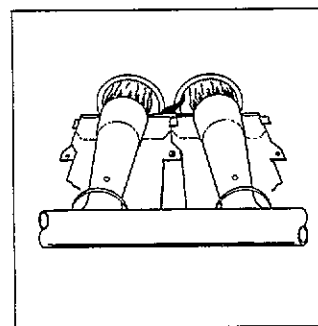

A91412

24

NOTE: If dirt, rust, soot, or scale accumulations are found, call your servicing dealer. **DO NOT OPERATE THE FURNACE.**

3. Inspect the vent pipe for a sag, holes, or a disconnection. A horizontal vent pipe must slope upward. If rusty joints or seams, or signs of water leakages are found call your dealer for service.

▲ WARNING

If holes are found—or if the vent pipe is obstructed or is not connected—toxic fumes can escape into your home. **DO NOT OPERATE YOUR FURNACE.** Call your dealer for service. A failure to follow this warning could result in personal injury or death.

4. Replace the access doors and restore electrical power to the furnace. Be sure bottom door flange is inside of the furnace casing. (See Fig. 15, 16, and 21.)
5. Start the furnace and observe its operation. If possible, watch the burner flames. Are they burning bright blue? If not (or if you suspect some other malfunction), call your servicing dealer.

BEFORE YOU REQUEST A SERVICE CALL

BEFORE YOU CALL FOR SERVICE, CHECK FOR SEVERAL EASILY SOLVED PROBLEMS:

Check for sufficient airflow. Check the air filter for dirt. Check for blocked return-air or supply-air grilles. Be sure they are open and unobstructed. If this isn't the cause, call your servicing dealer.

If your furnace isn't operating at all, check the following list for easily solved problems:

- Is your thermostat set above room temperature? Is the switch in the **HEAT** position?
- Is the electrical power supply switch **ON**? Is the blower access door firmly in place? Are any fuses blown—has a circuit breaker tripped? (There is a fuse on the furnace control board.)
- Is the manual shut-off valve in the gas supply pipe leading to the furnace open? Does the lever point in the same direction that the pipe runs (open)? Or is it at right angles (closed)?

NOTE: Before proceeding with the next checks, turn **OFF** the electrical power supply to the furnace. Remove the control access door. The blower access door must be installed to permit furnace operation. On downflow furnaces, the blower access door must be removed before the control access door is removed, then reinstalled.

- Is the control knob on the gas valve turned to the **ON** position? If this or the preceding check shows an interruption in the gas supply, make sure the gas has not been shut off for safety reasons.
- Check for pilot flame. If there is no pilot flame, follow the manual start-up procedures or the furnace lighting instruction label. If the pilot flame exists, check the control knob on the gas valve. If the knob is in the **PILOT** position, turn it to **ON** and complete the start-up procedures.
- If for some reason the vent is blocked, the draft safeguard switch will shut off the furnace. Reset the switch by pushing the button located on top of the switch (see page 3 for switch location).

If the switch trips a second time, turn off the furnace and call for service.

DOWNFLOW FURNACE ONLY—Check the manual-reset auxiliary limit switch located on the blower housing. If the blower motor fails, this switch will shut off the furnace. Reset it by pushing the button on the switch. If it trips again, turn off the furnace and call for service.

If your furnace still fails to operate, call your servicing dealer for troubleshooting and repairs. Tell them the model and serial numbers for your furnace. (You should have them recorded on page 2 of this booklet.) If the dealer knows exactly which furnace you have, they may be able to offer suggestions over the phone, or save valuable time through knowledgeable preparation for the service call.

REGULAR DEALER MAINTENANCE

In addition to the type of routine maintenance you might be willing to do, your furnace should be inspected regularly by a properly trained service technician. An annual inspection (or every other year, at least) should include the following:

1. Inspection of all flue product passages—including the burners, pilot and pilot tube, heat exchanger, relief box, and vent pipe.
2. Inspection of all combustion and ventilation air passages and openings.
3. Close check of all gas pipes leading to (and inside of) your furnace for leaks and/or deterioration.
4. Inspection, cleaning, and lubrication (when required) of the blower motor and wheel.

NOTE: Refer to the unit service procedures for blower motor oiling information. When required, the motor must be oiled by a qualified service technician.

5. Routine inspection and cleaning/replacement of the air filter.
6. Inspection of all supply- and return-air ducts for obstructions, air leaks, and insulation. Any problems found should be resolved at this time.
7. A check for loose connections attaching individual components. Inspection of all electrical wiring and their connections.
8. Operational check of the furnace itself to determine working condition. Repair or adjustment should be made at this time.
9. Check the physical support around the furnace base for cracks, gaps, sagging etc. Ensure there is a good air seal between the furnace and support.
10. Check burner and pilot flames. Compare flames to Fig. 24 for proper operation.

Your servicing dealer offers an economical service contract that covers seasonal inspections. Ask him for further details.

CARRIER CORPORATION



IF YOUR UNIT DOES NOT WORK, FOLLOW THESE STEPS IN ORDER:

- FIRST:** Contact the installer. You may find his name on the product or in your Homeowner's Packet. If his name is not known, call your builder if yours is a new residence.
- SECOND:** Contact the nearest CARRIER distributor. (See telephone yellow pages.)
- THIRD:** Contact:
CARRIER CORPORATION
Consumer Relations Department
P.O. Box 4808
Syracuse, NY 13221
1-800-CARRIER (227-7437)

Unit Model No. _____ Unit Serial No. _____
Date of Installation _____ Installed by _____
Name of Owner _____ Address of Installation _____

Carrier Corporation Indoor Gas-Fired Furnace Limited Warranty

LIMITED ONE-YEAR WARRANTY—This CARRIER CORPORATION product is warranted to be free from defects in material and workmanship under normal use and maintenance for a period of one year from the date of original installation, whether or not actual use begins on that date. A new or remanufactured part to replace any defective part will be provided at CARRIER CORPORATION'S sole option without charge for the part itself, PROVIDED the defective part is returned to our distributor. This warranty applies only to the product in its original installation location and is voided if the product is reinstalled elsewhere.

THIS WARRANTY DOES NOT INCLUDE LABOR OR OTHER COSTS incurred for diagnosing, repairing, removing, installing, shipping, servicing or handling of either defective parts or replacement parts. SUCH COSTS MAY BE COVERED by a separate warranty or service agreement provided by the installer which is separate and distinct from this factory warranty.

EXTENDED NINE-YEAR LIMITED WARRANTY ON HEAT EXCHANGER ONLY—During the second through tenth years after the date of original installation, CARRIER CORPORATION further warrants the heat exchanger against defects in material and workmanship under normal use and maintenance.

LIMITATION OF WARRANTIES—ALL IMPLIED WARRANTIES (INCLUDING IMPLIED WARRANTIES OF MERCHANTABILITY AND FITNESS FOR A PARTICULAR PURPOSE) ARE HEREBY LIMITED IN DURATION TO THE PERIOD FOR WHICH EACH LIMITED WARRANTY IS GIVEN AND APPLIES. SOME STATES DO NOT ALLOW LIMITATIONS ON HOW LONG AN IMPLIED WARRANTY LASTS, SO THE ABOVE LIMITATIONS MAY NOT APPLY TO YOU. THE EXPRESSED WARRANTIES MADE IN THIS WARRANTY ARE EXCLUSIVE AND MAY NOT BE ALTERED, ENLARGED, OR CHANGED BY ANY DISTRIBUTOR, DEALER, OR OTHER PERSON WHATSOEVER. ALL WORK UNDER THE TERMS OF THIS WARRANTY SHALL BE PERFORMED DURING NORMAL WORKING HOURS. ALL REPLACE-

MENT PARTS, WHETHER NEW OR REMANUFACTURED, ASSUME AS THEIR WARRANTY PERIOD ONLY THE REMAINING TIME PERIOD OF THIS WARRANTY.

CARRIER CORPORATION WILL NOT BE RESPONSIBLE FOR:

1. Normal maintenance as outlined in the installation and servicing instructions or owner's manual including filter cleaning and/or replacement and lubrication.
2. Damage or repairs as a consequence of faulty installation or application by others.
3. Failure to start due to voltage conditions, blown fuses, open circuit breakers or other damages due to the inadequacy or interruption of electrical service.
4. Damage or repairs needed as a consequence of misapplication, abuse, improper servicing, unauthorized alteration or improper operation.
5. Damage as a result of floods, winds, fires, lightning, accidents, corrosive environments or other conditions beyond the control of CARRIER CORPORATION.
6. Costs for replacement parts or repair services which are not supplied or designated by CARRIER and which are specifically covered under this Warranty.
7. CARRIER CORPORATION products installed outside the continental U.S.A., Alaska, Hawaii, and Canada.
8. Electricity or fuel costs or increases in electricity or fuel costs for any reason whatsoever, including additional or unusual use of supplemental electric heat.
9. ANY SPECIAL, INDIRECT, OR CONSEQUENTIAL PROPERTY OR COMMERCIAL DAMAGE OF ANY NATURE WHATSOEVER. Some states do not allow the exclusion of incidental or consequential damages, so the above limitation may not apply to you.

This warranty gives you specific legal rights, and you may also have other rights which vary from state to state.

Form No. 530-059 (New 5-90)



TO OBTAIN INFORMATION ON PARTS: Consult your installing dealer or classified section of your local telephone directory under the "Heating Equipment" or "Air Conditioning Contractors & Systems" headings for dealer listing by brand name. Have available the Model No., Series Letter & Serial No. of your equipment to insure correct replacement part.

Carrier Corporation • Syracuse, New York 13221

Manufacturer reserves the right to discontinue, or change at any time, specifications or designs without notice and without incurring obligations.

Free Manuals Download Website

<http://myh66.com>

<http://usermanuals.us>

<http://www.somanuals.com>

<http://www.4manuals.cc>

<http://www.manual-lib.com>

<http://www.404manual.com>

<http://www.luxmanual.com>

<http://aubethermostatmanual.com>

Golf course search by state

<http://golfingnear.com>

Email search by domain

<http://emailbydomain.com>

Auto manuals search

<http://auto.somanuals.com>

TV manuals search

<http://tv.somanuals.com>