

CI521 Freestanding Tumble Dryer
Manual for Installation, Use and Maintenance

CDA





Contents

Page 1	Important information
Page 2	User information
Page 3	How to use
Page 4	Filter Maintenance
Page 5	Installation
Page 6	Technical Data
Page 7	Technical information

Important

This appliance must only be used for the purpose for which it is intended, i.e. domestic use. Any other use could be dangerous and may lead to premature failure of the appliance.

The CDA Group Ltd cannot be held responsible for injuries or losses caused by incorrect use or installation of this product. Please note that CDA reserve the right to invalidate the guarantee supplied with this product following incorrect installation or misuse of the appliance.

This appliance is not designed to be used by people (including children) with reduced physical, sensorial or mental capacity, or who lack experience or knowledge about it, unless they have had supervision or instructions on how to use the appliance by someone who is responsible for their safety.

Under no circumstances should any external covers be removed for servicing or maintenance except by suitably qualified personnel.

Appliance information:

Please enter the details on the appliance rating plate below for reference, to assist CDA Customer Care in the event of a fault with your appliance and to register your appliance for guarantee purposes.

Appliance Model

Serial Number

CE Declarations of Conformity:

This appliance has been designed, constructed and marketed in compliance with safety requirements of EEC Directive 2006/95/EEC (Low voltage) and requirements of EMC Directive 2004/108/EEC.

This product is manufactured to comply with the radio interference requirements of the Council directive 82/336/EEC, 2004/108/EC.

IMPORTANT INFORMATION FOR CORRECT DISPOSAL OF THE PRODUCT IN ACCORDANCE WITH EC DIRECTIVE 2002/96/EC.

At the end of its working life, the product must not be disposed of as urban waste. It must be taken to a special local authority differentiated waste collection centre or to a dealer providing this service.

Disposing of a household appliance separately avoids possible negative consequences for the environment and health deriving from inappropriate disposal and enables the constituent materials to be recovered to obtain significant savings in energy and resources. As a reminder of the need to dispose of household appliances separately, the product is marked with a crossed-out wheeled dustbin. 

User Information

The room must be adequately ventilated to avoid the backflow of gases into the room from appliances burning gas or any other fuels. This includes open fires.

It is important to clean the lint filter after each drying cycle.

Items that have been soiled with substances such as cooking oil, acetone, alcohol, petrol, kerosene, spot removers, turpentine, waxes and wax removers should be washed in hot water with an extra amount of detergent before being dried in the tumble dryer.

Fabric softeners, or similar products, should be used as specified by the fabric softener instructions.

Remove all objects from pockets such as lighters and matches.

We recommend that the appliance is switched off each time after use. It should be disconnected from the electricity supply if it is to be unattended for long periods, (i.e. weekends or holiday etc).

- Do not** Overload the dryer.
- Do not** Dry articles singly as they tend to roll up and so increase drying time.
- Do not** Dry anything other than the recommended articles be placed in the tumble dryer. These can cause fires.
- Do not** Place articles which have been in contact with dry cleaning fluid, petrol, cooking oil, fat, hair laquer or other flammable substances in the tumble dryer.
- Do not** Attempt to dry dripping wet articles.
- Do not** Dry unwashed items in the tumble dryer.
- Do not** Dry wool or wool mixture articles unless the article is labeled as suitable. This should avoid shrinkage.
- Do not** Items such as foam rubber (latex foam), shower caps, waterproof textiles, rubber backed articles and clothes or pillows fitted with foam rubber pads should not be dried in the tumble dryer.
- Do not** Exhaust air must not be discharged into a flue which is used for exhausting fumes from appliances burning gas or other fuels.
- Do not** Allow the vent hose (where applicable) or filter to become blocked.
- Do not** Allow lint to accumulate around the tumble dryer.
- Do not** Use a two-way or multi-way adapter, or extension lead. The dryer must be connected to its own individual socket.
- Do not** Use the tumble dryer if you suspect that it is damaged in any way.

Never switch the dryer off and leave a hot load in the drum – risk of fire.

WARNING: Never stop a tumble dryer before the end of a drying cycle unless all items are quickly removed and spread out so the heat is dissipated.



This label positioned on the rear of your dryer, indicates the surface is hot when in operation – avoid touching this surface.

Use And Controls

A. The timer - turn the timer knob clockwise until the required programme around the timer knob is selected.

B. Heat setting - select gentle ☀ or intensive heat 🔥 as recommended on the control panel

C. Start - press the start button after selecting the required drying time.

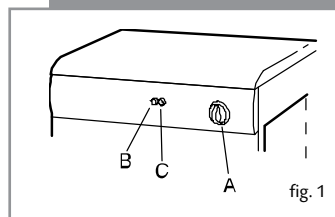

- Sort out the clothes into groups of similar fabrics and colours. Check the care label inside the garment. We suggest that fabric conditioner be used to reduce static electricity. Delicate articles e.g. tights should be placed inside a pillowcase. It is better to dry small and large articles together.
- Open the door.
- Load clothes loosely into the drum.
- Load sheets first starting with one corner.
- Close the door.
- Dry your hands.
- Check the timer is in the '0' position.
- Switch on the machine.
- Select correct heat position (See programme around the timer on fascia panel).
- Set the timer to the correct position (See programme around the timer on fascia panel).
- Press the start button.
- The drum will now begin to rotate and will stop automatically when the timer reaches the '0' position.
- Once the clothes are removed, clean the filter
- Switch off the electricity supply.

Should the clothes become dry before the cycle has finished the thermostat will automatically switch off the heater and prevent over drying and save energy although the drum will still rotate.

When drying large items such as sheets, we suggest you stop the dryer to redistribute the load.

To stop the machine during the middle of a programme, open the door: the drum will stop rotating automatically and reset when you close the door.

To lengthen or shorten the programme, turn the timer knob.

The final part of the drying cycle occurs without heat (cool down cycle) to ensure that the items will not be damaged.

Care labels you may find on your fabrics

<input type="checkbox"/>	'Suitable for tumble drying'
<input checked="" type="checkbox"/>	'Do not tumble dry'
<input type="checkbox"/>	'Dry flat'

Care And Maintenance

Cleaning The Filter

The filter is found, by opening the door (fig.2.) and must always be in position when drying items in the appliance.

To allow the dryer to operate efficiently the filter should be cleaned after each drying cycle.

Do not be alarmed by the amount of lint deposited on the mesh. It is not due to excessive wear caused by the dryer but more an indication of its efficient operation. All fabric loses lint when drying but it goes unnoticed into the air. In a tumble dryer it simply collects in the filter.

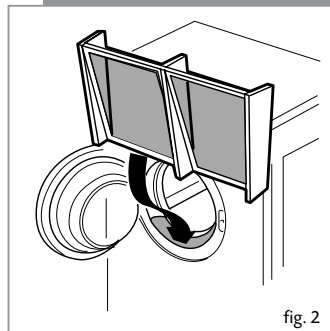

After removing the dried clothes clean the filter as follows:

- Pull the filter upwards.
- Remove any threat of lint by hand or with a soft brush.
- Slide the filter back.
- Wash the filter occasionally in detergent solution and with a soft brush remove small particles.

Troubleshooting

If the clothes are not dry after normal drying time:

- Check that the filter is clean.
- Check that you used the correct heat setting.
- Check that the vent hose is not blocked (sometimes a strong wind may cause a back pressure).
- Check that you have not set the timer within a cool down period.

If your appliance does not work, check the following points before contacting CDA Customer Care

- Check that there is power to the appliance.
- Check that the machine is switched on and the door properly closed.
- This appliance has a resettable cut-out. Check this has not operated. Press the red button on the right hand side at the back of your dryer. If the cut-out has operated the sharp "click" will be heard. This cut-out only operates if the airflow is severely restricted so make sure the filter is clean and that all other restrictions are removed before restarting.
- Check the fuse in the moulded plug.

Installation

Do not block the vent at the front or base of the dryer as this will impair the functioning of the appliance and could cause it to overheat. This appliance must not be installed behind a lockable door, a sliding door or a door with hinges on the opposite side to that of the tumble dryer.

Tumble dryer venting

Your tumble dryer will release warm, damp air in one of three ways.

- 1) **Extendable rear venting** - a long flexible vent hose is built into the dryer and can be extended from the large opening at the rear of the machine
- 2) **Fixed rear venting** - venting is through the large opening at the bottom of the rear panel. A separate extendable vent hose can be attached if desired.
- 3) **Front venting** - this is a special type of dryer which vents through a grille on the plinth. The opening on the rear panel is blanked off during manufacturing.

Rear vented dryers can be used without a vent hose but not in a confined space. Rear vented machines must have a vent hose if they are installed under a work surface. To minimise condensation it is preferable to vent through a vent to outside. This may be through an open door or window. The best solution is to connect the vent hose to a permanent connection through a wall or a single glazed window. This is particularly recommended for small, cool rooms. Front venting machines must be converted to extendable rear venting before a permanent connection can be made to the outside.

When using a vent hose, remember the following points:

The vent hose must be at least 10cm (4 ins) in diameter.

No more than three right-angled bends should be allowed when positioning the vent hose.

Do not distort or constrict the vent hose as this will reduce the airflow.

The vent hose must not be shared with other appliances, for example, a cooker hood outlet.

Reversing The Door

The door on the dryer can be positioned either with the left or right hand hinging, as shown in figure fig.4.

Please note: power tools must not be used when reversing the door.

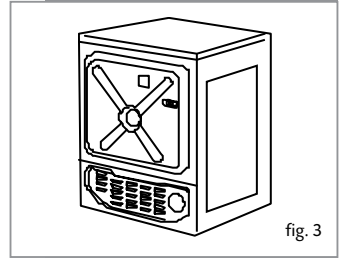

fig. 3

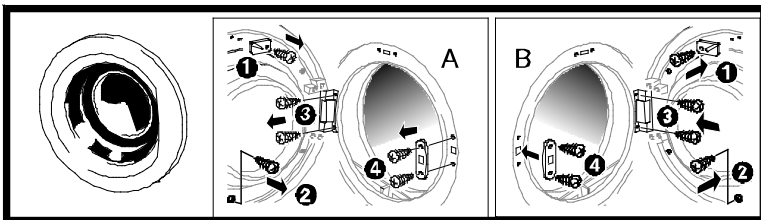
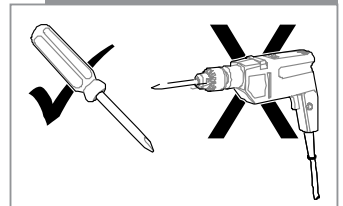
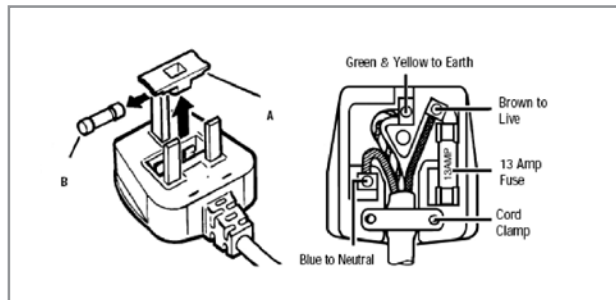

fig. 4

Electrical information

Warning! This appliance must be earthed.



The mains lead of this appliance has been fitted with a BS 1363A 13 amp fused plug. To change a fuse in this type of plug, follow the steps below:

1. Remove the fuse cover and fuse.
2. Fit a replacement 13A fuse, ASTA approved to BS 1362 type, into the fuse cover.
3. Replace fuse cover.

Important: Do not use the appliance without the fuse cover in position.

How to connect an alternative plug

If the fitted plug is not suitable for your socket outlet, then it should be cut off and disposed of safely to avoid possible shock hazard. A suitable alternative plug of at least 13 Amp rating to BS 1363 should be used.

As the colours of the wires in the mains lead of this appliance may not correspond with the coloured markings identifying the terminals in your plug, proceed as follows:-

- The wire which is coloured GREEN and YELLOW must be connected to the terminal which is marked with letter (E) or by the Earth symbol \perp or coloured GREEN and YELLOW.
- The wire which is coloured BLUE must be connected to the terminal which is marked with the letter (N), or coloured BLACK.
- The wire which is coloured BROWN must be connected to the terminal which is marked with the letter (L) or coloured RED.

If in doubt regarding the electrical connection of this appliance, consult a qualified electrician. Do not shorten the supply cable, the appliance may require removing for servicing.

N.B. Ensure that the plug socket is situated in an easily accessible place.

Technical information:

Overall dimensions :	85cm x 59.5cm x 58cm (height x width x depth)
Maximum dry weights:	Cotton or linen 6.0kg.
Maximum dry weights:	Synthetics 2.0kg.
Fuse rating:	13 A

For electrical ratings see plate on rear of machine.





4213 194 03011

|C|D|A|

To contact our Customer Care Department, or for Service,
please contact us on the details below.

Free Manuals Download Website

<http://myh66.com>

<http://usermanuals.us>

<http://www.somanuals.com>

<http://www.4manuals.cc>

<http://www.manual-lib.com>

<http://www.404manual.com>

<http://www.luxmanual.com>

<http://aubethermostatmanual.com>

Golf course search by state

<http://golfingnear.com>

Email search by domain

<http://emailbydomain.com>

Auto manuals search

<http://auto.somanuals.com>

TV manuals search

<http://tv.somanuals.com>