

HCC762 Ceramic Hob

Manual for Installation, Use and Maintenance

|C|D|A|



CE



Important

The CDA Group Ltd cannot be held responsible for injuries or losses caused by incorrect use or installation of this product. Please note that CDA reserve the right to invalidate the guarantee supplied with this product following incorrect installation or misuse of the appliance or use in a commercial environment.

This appliance is not designed to be used by people (including children) with reduced physical, sensorial or mental capacity, or who lack experience or knowledge about it, unless they have had supervision or instructions on how to use the appliance by someone who is responsible for their safety.

Under no circumstances should any external covers be removed for servicing or maintenance except by suitably qualified personnel.

Appliance information:

Please enter the details on the appliance rating plate below for reference, to assist CDA Customer Care in the event of a fault with your appliance and to register your appliance for guarantee purposes.

Appliance Model	
-----------------	--

Serial Number	
---------------	--

CE Declarations of Conformity:

This appliance has been manufactured to the strictest standards and complies with all applicable legislation, including Electrical safety (LVD) 2006/95/EC and Electromagnetic interference compatibility (EMC) 2004/108/EC. Parts intended to come into contact with food conform to 89/109/EC. This appliance also conforms to requirements of directive 93/68/EEC.

IMPORTANT INFORMATION FOR CORRECT DISPOSAL OF THE PRODUCT IN ACCORDANCE WITH EC DIRECTIVE 2002/96/EC.

At the end of its working life, the product must be taken to a special local authority waste collection centre or to a dealer providing appliance recycling services.

Disposing of a household appliance separately avoids possible negative consequences for the environment and health. It also enables the constituent materials to be recovered, saving both energy and resources. As a reminder of the need to dispose of household appliances separately, the product is marked with a crossed-out wheeled dustbin. 

Please note:

Before operating this hob, please read the instructions carefully

After unpacking the appliance, make sure it is not damaged. In case of doubt, do not use the appliance and contact your supplier.

Remove all packaging and do not leave the packing materials in easy reach of children as they may cause serious injury. The packaging materials are recyclable.

Always disconnect the appliance from the power supply before undertaking any cleaning or maintenance.

Ceramic hobs become hot and remain hot during and immediately after use. Do not touch the hob until it has been allowed to cool.

After use, please ensure that all the zones have been switched off.

Keep children away from the appliance when in use.

Pan handles should never stand out beyond the edge of the worktop. This will ensure children cannot reach them.

Do not use pans with rough bases (e.g. cast iron) as these may scratch the hob surface.

Ensure the base of the saucepan is clean and dry before placing it on the zone.

Do not switch on the zones without cookware in place.

Do not lean over the hob when it is in use.

Do not drop heavy or sharp objects on to the hob top.

Do not scratch the hob top with sharp objects.

Follow the cleaning instructions carefully.

Never put cooking foil or plastic materials on the hob top when it is hot. These materials could melt and cause damage to the hob.

Do not leave inflammable materials on the hob top.

Never use the hob top for storage or as a worktop.

Do not leave wet or damp pan lids on the hob.

Important

Do not use the hob if the glass surface is cracked or damaged to prevent risk of electric shock, Disconnect it from the power supply.

Do not use the hob if the electrical cord is damaged.

When correctly installed, this hob meets all the safety requirements laid down for this type of product. However, special care should be taken around the underneath of the appliance as this area is not designed or intended to be touched and may contain sharp or rough edges, that may cause injury.

This hob (Class 3) has been designed for use only as a cooking appliance. Any other use (e.g. heating rooms) should be considered incorrect and therefore dangerous.

This appliance is not intended to be operated by any means of an external timer or separate remote control system.

Make sure that electrical cords connecting other appliance do not come into contact with the hob top.

Before disposing of an unwanted appliance, it is recommended that it is made inoperative and that all potentially hazardous parts are removed.

Using your hob

Zones:

1. Front left 0.7/2.1 kW 120/210 mm dual
2. Rear left 1.2 kW 140 mm
3. Rear right 1.1/2 kW 145 x 270 mm dual
4. Front right 1.2 kW 140 mm
5. Touch control panel

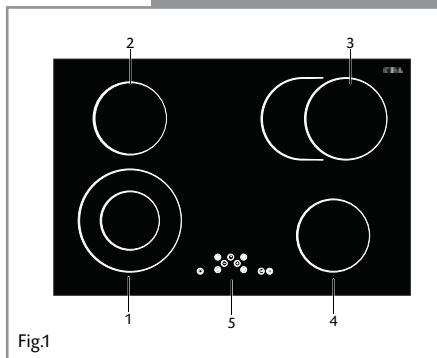

The Touch Control

- 1 Dual zone key
- 2 Minus key (for all zones)
- 3 Timer key
- 4 Plus key (for all zones)
- 5 Zone selection key
- 6 Childlock key
- 7 Power key
- 8 Timer display
- 9 Timer zone indicator
- 10 Zone display
- 11 Dual zone indicator
- 12 Childlock indicator

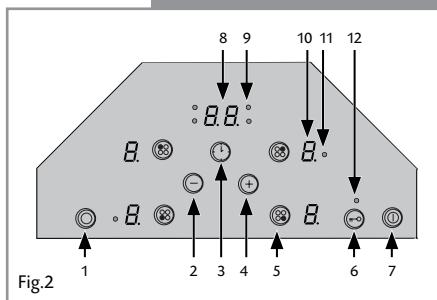

How to use the hob

The ceramic surface of the hob allows fast transmission of heat vertically from the heating elements under the glass to the pans on the hob top.

The heat does not spread horizontally, so the hob top remains relatively cool only a few centimetres from the zone in use.

To switch the hob on

Touch and hold  until the zone displays show **0** or **H** and the zone indicators flash.

Please note:

If a zone is not selected within 10 seconds, the hob will automatically switch off.

To switch on a zone

Once the hob is switched on, touch  for the zone required. The zone indicator will switch on to confirm the zone is active.

Touch and hold  to select the power level from 1 (minimum) to 9 (maximum). The power level selected will show on the zone display.

If required, touch  again to deactivate the touch control for the zone.

To adjust the power level once set

Touch  for the zone required. The zone indicator will switch on to confirm the zone is active.

Touch and hold  or  until the required power level shows on the zone display.



To use the dual zone

The dual zones are formed of two separate coils of resistant material.

Once the zone is switched on, touch  at any time to switch the dual zone on or off. The dual zone indicator will switch on when the dual zone is on.

To switch off a zone

Touch  for the zone required.

EITHER Touch  and  at the same time.

OR Touch  until the zone display shows **0**.

The zone display will show **0** for approximately eight seconds before showing **H** to indicate the residual heat.

To switch the hob off

Touch and hold  at any time.

How to use the hob

Power Level	Type of cooking
0	Switched off
1/2	For melting (butter/chocolate) or keeping food warm
2/3	Keeping food hot or to heat small quantities of liquid
3/4	Heating large quantities of liquid (sauces etc.)
4/5	Slow boiling e.g. spaghetti, soups, stews, potatoes
6/7	Gentle frying
7/8	Browning meats, frying fish. omelettes
9	Fast frying steaks

Booster

The hob is equipped with a booster function, which allows a zone to run at maximum power for a preset period of time before returning to the required power level. These times are shown in the table. To set the booster, follow the steps below.

Once the hob is switched on, touch  for the zone required. The zone indicator will switch on to confirm the zone is active.

Touch  so the zone display shows **9**.

Touch  again to set the required power level. The zone display will alternate between the required power level and **A** until the booster is complete, then it will show the required power level.

Cooking zone power level	1	2	3	4	5	6	7	8	9
Fast heating time	1 min. 22 sec.	2 min. 44 sec.	4 min. 6 sec.	5 min. 28 sec.	6 min. 50 sec.	1 min. 22 sec.	2 min. 44 sec.	2 min. 44 sec.	n/a

How to use the hob

The Timer / Minute Minder

The timer allows you to preset the length of time any of the zones will be on, between a minimum of one minute and a maximum of 99 minutes. The timer can be used on each zone separately and can also be used as a minute minder, to countdown the time without using any of the zones.

To set the minute minder

Switch on the hob

Touch \odot . The timer display will show **00** and a dot will show on the timer display.

EITHER Touch and hold \oplus until the required time shows on the display to set the time from zero.

OR To go straight to 99 minutes, touch \ominus .

Then touch either \oplus or \ominus to adjust the time further. After approximately ten seconds, the hob will beep to confirm.

The timer will start as soon as the time has been set.

At the end of the set time:

The timer display will show **00**.

The hob will beep for approximately 2 minutes. To switch off the beep and turn off the timer display, touch any key.

To set the timer

Switch on the hob, select the zone and set the power level.

Touch \odot . The timer display will show **00** and a dot will show on the timer display. The timer zone indicator will flash to show which zone timer is being set. If more than one zone is in use, touch \odot repeatedly until the required timer zone indicator flashes.

EITHER Touch and hold \oplus until the required time shows on the display to set the time from zero.

OR To go straight to 99 minutes, touch \ominus .

Then touch either \oplus or \ominus to adjust the time further.

Please note:

The timer will start as soon as the time has been set.

If more than one zone timer is set, the timer display will show the countdown with the least time to run.

At the end of the set time:

The zone will switch off

The timer display will show **00**, then will switch off if no other timers have been set

The zone display will show **H** to indicate the residual heat.

The hob will beep for approximately 2 minutes. To switch off the beep, touch any key.

If no other zones are in use, the hob will switch off automatically.

To change the timer once set

Touch \odot for the required zone.

Touch either \oplus or \ominus to adjust the time.

To cancel the timer once set

Touch \odot for the required zone.

EITHER Touch \oplus and \ominus together to cancel the timer.

OR Touch \ominus until the timer display shows 00.

Please note:

If you cancel the timer, the zone will continue at the set power level until it is switched off as described above.

Safety Features

The childlock

The hob is equipped with a childlock to lock all the controls except , for safety reasons. This can be used when the hob is switched off or during cooking.

To switch the childlock on and off

Touch  to switch the hob on.

Touch  for approximately two seconds. The childlock indicator is illuminated when the childlock is set and the hob is on.

Residual Heat Indicators

The hob is equipped with residual heat indicators to warn when any of the zones are still hot to the touch after cooking.

An **H** will show in the relevant zone display after cooking until the zone is at a safe temperature to touch.

Please note:

You should avoid touching the zones when the hob is in use, or when an **H** is showing on the zone display.

In the event of a power cut, the residual heat indicators will flash after the power supply is restored. However, when there is no power supply to the hob the residual heat indicators will not work, so extra care must be taken.

Touch Control Safety

The hob will not operate if an object is left on the touch control for more than ten seconds. The hob will switch off, the zone display will flash **F** and the hob will beep every 30 seconds until the object is removed.

If the object is left on the childlock key, the childlock will switch on automatically and will need to be switched off before the hob can be used.

Auto-stop Protection

The hob is equipped with a sensor that will switch off the zone after a factory set period of time if not keys are touched once the zone is switched on.

Cooking zone power level	1	2	3	4	5	6	7	8	9
Time Limit (hours)	10	5	5	4	3	2	2	2	1

Efficient Use of your Hob

The hob is equipped with zones of different sizes, designed to accommodate most shapes and sizes of pan. For best results, only use pans with flat bottoms and choose an appropriate zone depending on the size of the pan. The most efficient use of the hob is shown below, where the pan and zone are correctly chosen.

Use pan lids where possible to minimize the energy usage of your appliance.

As the zone will remain hot for a period of time after it has been switched off, five to ten minutes before the planned end of cooking time, turn the zone off. The residual heat in the hob will be sufficient to finish the cooking.

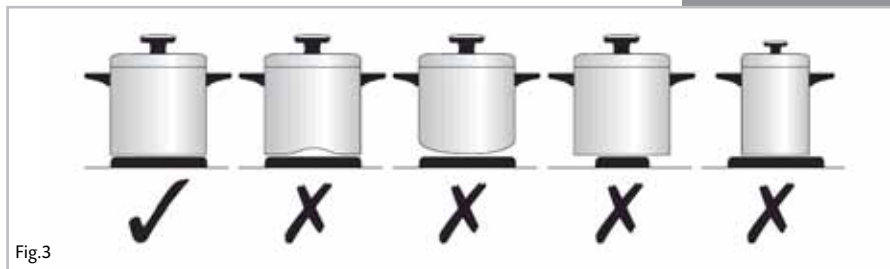

Fig.3

Zone Size	Minimum Pan Size (mm)	Maximum Pan Size (mm)
120 mm	100	150
140 mm	120	160
210 mm	180	239
145 x 270 mm	120	160 (290 with dual zone in use)

It is very important that the pans used on the hob are made of a suitable material and have the correct type of base. The base should be flat and smooth, as any rough part on the pan base could scratch the ceramic hob top.

Choose pans which are between the sizes recommended in the table above, and with bases that are as non-reflective as possible, e.g. dull and dark.

Only pans recommended for use on ceramic hobs should be used.

Pans with aluminium bases may leave silver streaks or spots on the hob. Glassware and pans with rough circular machined bases should not be used.

Care and Maintenance

Always disconnect the appliance from the power supply before undertaking any cleaning or maintenance.

You should use a non-abrasive cleaner to clean the hob top. Any abrasive cleaner (including Cif) will scratch the surface and could erase the control panel markings.

Do not use steel wool, abrasive sponges or sharp utensils such as knives to clean the hob as these could damage the hob. The hob surface and the pans must be clean.

Carefully remove any food remains (especially those containing sugar), dirt etc. as soon as is possible after spillage - using a ceramic hob scraper if necessary whilst the zone is still hot.

Once they have cooled and hardened they become increasingly difficult to remove.

Sugar, syrup and starch mixtures could permanently pit the hob surface if left to burn on and should be removed as quickly as possible after spillage.

The stainless steel trims should be rinsed with water and dried with a soft, clean cloth, a chamois leather or an E-Cloth.

All cleaner residues should be removed with a damp cloth.

Types of residues	Clean with	Cleaning advice
Light	Cleaning sponge and soft cloth	Wipe over the zone to be cleaned with a sponge and hot water, and then wipe off with a soft dry cloth.
Accumulated baked-on stains / dirt, sugar spills or melted plastics	Cleaning sponge or glass scraper and soft cloth	Wipe over the zone to be cleaned with a sponge and hot water, using a ceramic scraper to remove any large marks or stains and then wipe off with a soft dry cloth.
Rings and hard water residues	White vinegar and soft cloth	Pour a small amount of warm white vinegar onto the stain, leave it to stand, and then wipe off with a soft dry cloth.

Important:

- Steam cleaners must not be used when cleaning this appliance.

Mains electrical voltage: 230 – 240Vac

Total rated electrical consumption: 6.5 kW

If your Hob is not working:

1. Check that the required zone is switched on.
2. Check that the mains supply has not been switched off.
3. Check that the fuse in the spur has not blown.

Contact CDA Customer Care

A : Customer Care Department, The CDA Group Ltd, Harby Road, Langar, Nottinghamshire, NG13 9HY

T : 01949 862 012 F : 01949 862 003 E : service@cda.eu W : www.cda.eu

Mains Electricity Connection

Warning! this appliance must be earthed

We recommend that the appliance is connected by a qualified electrician, who is a member of the N.I.C.E.I.C. and who will comply with the I.E.E. and local regulations.

This appliance is intended to be connected to fixed wiring and is not suitable for connection to a 13A plug or 13A supply.

This appliance is intended to be connected to fixed wiring by a double pole switch, having a contact separation of at least 3mm in all poles. The switch must be positioned no further than 2m from the appliance.

Please note:

- The mains cable must only be replaced by a qualified electrician or service engineer and must be of equivalent or better rating (i.e. 2.5mm², HO5RR-F).
- This appliance is intended to be connected to the mains supply with a cable of cross section area 2.5 mm². A larger cable will not fit the terminal connections.
- The marking of the current rating of the fuse or circuit breaker protecting this appliance should be marked on the socket outlet.
- Assembly and electrical connection should be carried out by specialised personnel.
- When installing this product we recommend you seek the help of another individual.
- Ensure that the brass links are securely fitted. Failure to do so will prevent the hob from operating correctly.

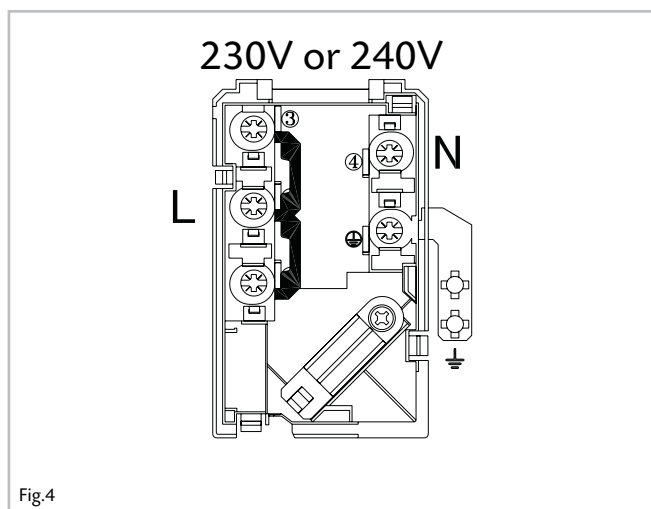

Fitting the Hob

Unpacking the hob:

Take care not to lose or mishandle any parts.

Fitting position of the hob:

This appliance must be installed a minimum of 50mm from any back wall and a minimum of 190mm away from any adjacent vertical surfaces, e.g. a tall cupboard end panel. This may be reduced to 100mm if the adjacent surface is resistant to fire (tiles or steel, for example). These dimensions are shown in Fig.5.

If fitting a cooker hood above the hob:

If a cooker hood is to be installed above the hob, the height of the hood above the hob must be at least 600mm (650mm is recommended) (Fig.6). If the instructions supplied with the hood dictate that the hood must be installed at a height greater than 600mm, then that height is the minimum required.

Wall furniture requirements:

The minimum height of any cabinet immediately above the hob is 900mm. The minimum height of any adjacent units (including light pelmets) is 400mm, unless they are manufactured from a material resistant to fire (steel, for example)

Notes:

- Do not position this appliance above a refrigeration unit. The heat generated may cause the refrigeration unit to fail.
- This appliance is designed to be installed into cabinet units capable of withstanding temperatures of 65°C or greater above ambient temperature.
- If there is no oven to be built in below the hob, an isolation shelf should be fitted to protect the user from high temperatures. If the hob is to be installed above a working drawer, then a partition should be fitted to protect the contents and user from the heat generated during use.
- Never place perishable foods in the cupboard below the appliance.

How to Install the Hob

How to install the hob:

Overall dimensions of the hob: Width: 770mm Depth: 510mm

Worktop cut-out dimensions: Width: 740mm Depth: 480mm

1. Make the required hole in the worktop. Before doing this, you must check the instructions supplied with any cooker hood to ensure that you will have the required clearance. The cut-out (Fig5) shows a 60mm gap from the wall to the cut-out edge. The distance from the hob, when fitted, to the back wall is 50mm. If a splashback/worktop upstand is to be fitted, take this into account when cutting the hole. The minimum distance that the hob should be positioned away from the rear wall or splashback is 50mm.
2. Position the hob seal, as shown in (Fig.7), ensuring that the ends meet without overlapping. Do not use silicone type sealant.
3. Secure the hob to the worktop using the fixing brackets and screws supplied, as shown in (Fig.8). Remove any excess sealant after tightening the brackets. Do not over-tighten the fixing brackets.

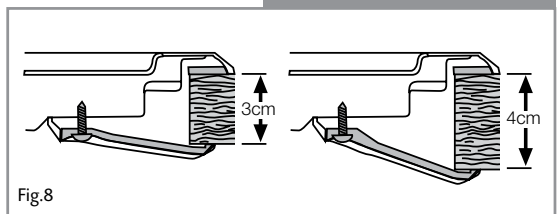
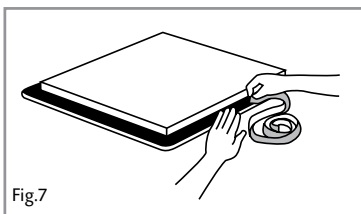
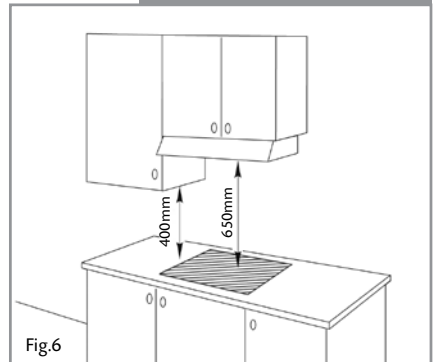
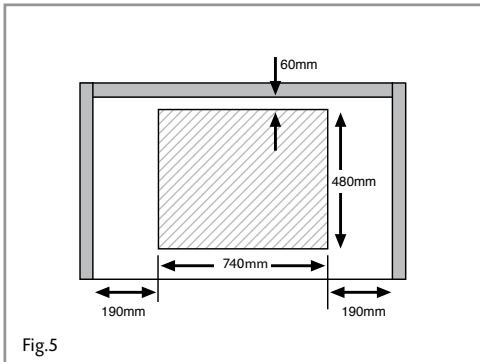







To contact our Customer Care Department, or for Service,
please contact us on the details below.

Free Manuals Download Website

<http://myh66.com>

<http://usermanuals.us>

<http://www.somanuals.com>

<http://www.4manuals.cc>

<http://www.manual-lib.com>

<http://www.404manual.com>

<http://www.luxmanual.com>

<http://aubethermostatmanual.com>

Golf course search by state

<http://golfingnear.com>

Email search by domain

<http://emailbydomain.com>

Auto manuals search

<http://auto.somanuals.com>

TV manuals search

<http://tv.somanuals.com>