

**SC145 Six Function Slimline
electric multi-function oven**
Manual for Installation, Use and Maintenance

CDA



Dear Customer,

Thank you for choosing our product. This appliance is easy to use; read this handbook carefully before installing and using it, however. You will find the correct indications for the best installation, use and maintenance of the product.

- Very important: keep this instruction booklet with the appliance in case you pass it on to someone else.
- **This appliance is designed for non professional use by private individuals at home. It must be used by conscious adults, do not allow children to play with it. The front accessible parts of the equipment could overheat during use.**
- **Supervise children and non self-sufficient people when it is being used so that they do not touch hot surfaces and are not near the appliance while it is in use.**
- **Don't touch the heating elements inside the oven.**
- The product installation must be performed by competent and qualified installers who are aware of the installation regulations in force.
- Before maintenance or cleaning disconnect the appliance from the mains and wait for it to cool down.
- The user must not change the appliance supply cable. For replacement contact only a qualified engineer.
- Never line the oven with aluminium sheets as the slots preset for keeping fast the thermic exchange may clog, thus damaging the enamel.
- **WARNING:** accessible parts may become hot during use. Young children should be kept away.
- For any repairs always contact an authorised Technical Customer Service Centre and ask for original spare parts. Repairs by untrained people can lead to damage.

ELECTRICAL CONNECTION

The appliances are provided with a three-pole feeding cable and work with alternate current and single-phase voltage indicated on the “rating plate of the product “report at the end of the instruction manual and on the product. The grounding conductor of the cable is marked with the colours yellow/green.

CONNECTION OF THE FEEDING CABLE TO THE MAINS

Connect the feeding cable of the oven to a plug suitable for the load indicated on the rating plate of the product. In case of a direct connection to the mains (cable without plug), it is necessary to insert a suitable omnipolar switch before the appliance, with minimum opening between contacts of 3 mm (the grounding wire should not be interrupted by the switch).

Before connecting to the mains, make sure that:

- the electrical counter, the safety valve, the feeding line and the socket are adequate to withstand the maximum load required (see rating plate).
- the supply system is regularly grounded, according to the regulations in force.
- the socket or the omnipolar switch can easily be reached after the installation of the oven
- after carrying out the connection to the mains, check that the supplying cable does not come into contact with parts subject to heating.
- never use reductions, shunts, adaptors which can cause overheating or burning.

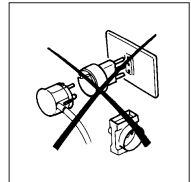

The manufacturer is not liable for any direct or indirect damage caused by faulty installation or connection. It is therefore necessary that all installation and connection operations are carried out by qualified personnel complying with the local and general regulations in force.

This appliance complies with EEC Specification:

- 73/23 + 93/68 (low voltage equipment)
- 89/336 (electromagnetic compability)
- 89/109 (components coming in contact with foodstuffs)
- 2002/96 (WEEE)

INSERTION AND ASSEMBLY

Insert the oven into the opening of the furniture, resting it on the base and pushing it as far as the ledge of the side stanchions against the shoulder of the piece of furniture. For the dimensions of the oven see furniture and technical data.

•Open the door and fix the oven with four wood screws to be screwed up through the holes in the side stanchions of the oven.

Pay attention to fix the oven in an absolutely firm way, as above indicated, and to insulate the electrical elements in order to avoid an eventual contact with metallic parts .

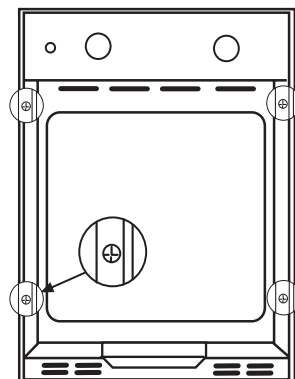

Moreover, the bonding agent joining the rolled sections to the piece of furniture has to stand temperatures no lower than 90°C to avoid deformations and coating disjunction. In case a plane is inserted, the electrical connection of the plane and that of the oven should be carried out separately, both for electrical reasons and to facilitate the frontal extractibility of the oven.

Once the electrical connection has been carried out, apply voltage to the oven only after installing it.

Before using the oven, we suggest to:

- remove the special film covering the oven door glass (when provided)
- heat the empty oven at max. temperature for 45 minutes (to remove unpleasant smell and smoke caused by working residues and by the thermal insulation)
- carefully clean inside the oven with soapy water and rinse it .

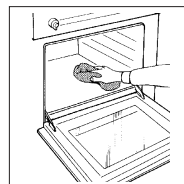

IMPORTANT: When running, the front side of the appliance gets quite hot. See that children do not get near the oven.

The selector A and thermostat B control is used to select the various oven functions and to choose the cooking temperatures best corresponding to the food to be cooked. During oven operation the lamp will always remain on.



The lamp of the oven is on, with no heating elements operated (electrical resistances). During oven operation the lamp will always remain on.

TRADITIONAL COOKINGS



Upper and lower heating elements operated; temperature adjustable from 50°C to MAX on the thermostat.

CONVECTION COOKINGS



Upper and lower heating elements operated and the motor-fan; temperature adjustable from 50°C to MAX on the thermostat.

GRILL COOKINGS



Grill element operated; turn the thermostat to position 200°C.



Cut in the grill element and the motor-fan. Turn the thermostat to position 200°C.

DEFROSTING



The motor-fan is operated; by stirring the cold air inside the oven, it favours a quick defrosting of the freeze-d aliments. No heating elements is operated.

The oven door must be closed for all cooking methods

A

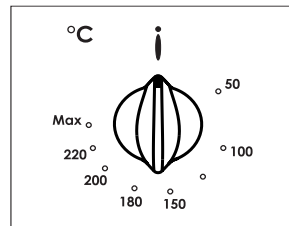
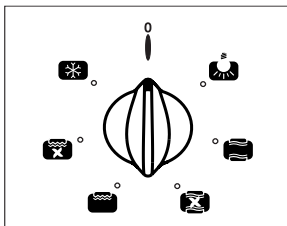

B

PILOT LIGHT OF THE THERMOSTAT (°C)

It comes on any time the thermostat settles the cooking temperature inside the oven and it is switched off when the oven reaches the preset temperature.

SAFETY THERMOSTAT

It cuts out the electric supply for preventing possible overheatings when the appliance is not correctly used. In this case, wait that the oven cools down before using it again. On the other hand, if a fault is present on the appliance's components, we advise calling the Technical Assistance Service.

COOLING MOTOR

The equipment comes with a motor for cooling the inside elements. This motor starts automatically when using the oven.

INSTRUCTIONS FOR COOKING

OVEN COOKINGS

For a perfect cooking it is necessary to pre-heat the oven to the preset cooking temperature. Only vary fat meat can be placed into a cold oven. Never use low-edged containers nor trays as baking-pan for roasts, in order to soil the minimum possible the walls of the oven, thus preventing fat splashes, sauce burning and smoke production. Use instead high-edged containers, preferably terracotta containers, put on the grate at about half the height of the oven. The table shows some examples of how to set the thermostat and the cooking time. The cooking times vary according to the type of food, its homogeneity and volume. We are sure that, after a few endeavours, the experience will suggest possible variations to the values shown on the table.

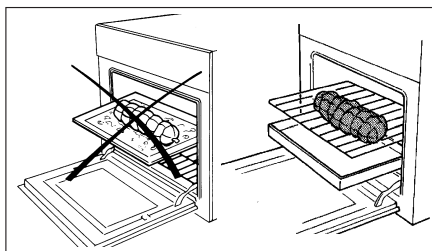

Practical hints to save energy

The oven can be switched off some minutes before cooking end; the residual temperature is enough to complete cooking. Open the oven door only when it is absolutely necessary; to check the cooking phase, look through the glass (the oven lamp is always on).

Pieces of general advice

The oven offers various kinds of heating:

- the traditional heating for the cooking of special roasts
- the ventilated heating for the cooking of cakes, biscuits and similar.

If the ventilated heating is chosen, it is recommended to take advantage of it for cooking of roasts on more shelves or for the preparation of complete menus, with time and energy economy.

Ventilated heating



By this function a continuous circulation of warm air is created, fit for the cooking on more shelves. The temperature are inferior to the traditional ones.

Traditional heating



It is especially suitable for the cooking of furred and feathered game and as well as for the cooking of bread and sponge cakes.

It is advisable to insert the aliments to be cooked into the oven when this is reached the cooking temperature, that is to say when the pilot light of the thermostat estinguishes.

INSTRUCTIONS FOR COOKING

GRILL COOKINGS



To cook on the grill or on the grate, pre-heat the oven for about 5 minutes. During grill operation the heat comes from above; it is based on the infrared radiation and is fit for low thickness meat and for toasts. The meat and the fish to be grilled are to be slightly oiled and always placed on the grate; this is to be arranged on the nearest or on the farthest guide from the grill element, according to the thickness of the meat to be cooked. The table shows some examples of cooking times and food positions. The cooking times vary according to the type of food, its homogeneity and volume.

COOKING OF THE PASTRY

The air circulation of the oven assures an instantaneous and uniform heat distribution. The forewarming of the oven is no longer necessary. However for specially delicate pastry the oven can be forewarmed. More trays can be inserted into the oven together with the pastries, taking care not to use the first grid starting from above. Together with the pastry, also other aliments of different nature can be cooked at the same time (fish, meat, etc.) without any transmission of smells and savours. These multiple cookings can be carried out only provided that, although having different cooking times, the aliments to be cooked have the same cooking temperature.

GRATINATING



By this term is meant the surface alteration of an aliment, often forecooked, when, after being introduced into the oven, it takes a golden-brown and crisp aspect. "Gnocchi alla romana", polenta pasticciata", rice, lasagnas, noodles and vegetables dressed with bechamel are typical preparation for this type of cooking.

DEFROSTING



The defrosting takes place in the same way as at room temperature, but with the advantage that is much more rapid. The ten hours of the refrigerator are reduced to an hour for a kilogram of meat. Put the meat envelope into its packing on a dish. Introduce it into the oven.

COOKING TIMES

The table shows some examples for the adjustment of the thermostat and of the cooking time.

The cooking times can vary according to the type of food, its homogeneity and volume. We are sure that, after a few endeavours, the experience will suggest possible variations to the values shown on the table.

REMARK:

- For the beef, veal, porc and turkey roasts, with bones or rolled, add about 20 minutes to the times shown in the table.
- The indication suggested on the table for the use of the steps is the preferential one in the case of the cooking of several aliments.
- The times indicated in the table refer to the cooking of one aliment only; for more than one aliment, the cooking times should be increased by 5 - 10 minutes.

Table of cooking times

Nature of food	Guide No.	Oven Temp. °C	Time Minutes													
	<table border="1" style="display: inline-table; vertical-align: middle;"> <tr><td style="width: 10px; height: 10px;"></td><td style="width: 10px; height: 10px;"></td><td style="width: 10px; height: 10px;"></td><td style="width: 10px; height: 10px;"></td></tr> <tr><td style="width: 10px; height: 10px;"></td><td style="width: 10px; height: 10px;"></td><td style="width: 10px; height: 10px;"></td><td style="width: 10px; height: 10px;"></td></tr> <tr><td style="width: 10px; height: 10px;"></td><td style="width: 10px; height: 10px;"></td><td style="width: 10px; height: 10px;"></td><td style="width: 10px; height: 10px;"></td></tr> <tr><td style="width: 10px; height: 10px;"></td><td style="width: 10px; height: 10px;"></td><td style="width: 10px; height: 10px;"></td><td style="width: 10px; height: 10px;"></td></tr> </table>															
FOOD																
<i>Long-cooking roast</i>	2	220-230	dep. on qty													
<i>Quick cooking roast</i>	2	225-230	50-60													
<i>Fowl (Guinea hen, duck, etc)</i>	1	210-230	150-180													
<i>Poultry</i>	2	225-230	50-60													
<i>Game</i>	1	200-225	dep. on qty													
<i>Fish</i>	1	180-200	20-25													
PASTRIES																
<i>Christmas cake</i>	Base only	160-200	60-70													
<i>Plum-cake</i>	"	170-180	90-100													
<i>Orange cake</i>	"	170-180	80-100													
<i>Savoy biscuits</i>	2	200	40-45													
<i>Brioche</i>	2	215-230	35-40													
<i>Puff pastry</i>	2	215	30-40													
<i>Sponge cake</i>	2	200-215	30-35													
<i>Meringues</i>	1	140	60-80													
<i>Cream puff pastry</i>	2	215-230	30													
<i>Fruit cake (unleavened pastry)</i>	2	230	30-35													
<i>Fruit cake (leavened pastry)</i>	2	230	20-30													

Table of grill cooking times

Nature of food	Qty.Kg	Guide No.	Temp.°C	Pre-heat time in minutes	Time in min.											
		<table border="1" style="display: inline-table; vertical-align: middle;"> <tr><td style="width: 10px; height: 10px;"></td><td style="width: 10px; height: 10px;"></td><td style="width: 10px; height: 10px;"></td><td style="width: 10px; height: 10px;"></td></tr> <tr><td style="width: 10px; height: 10px;"></td><td style="width: 10px; height: 10px;"></td><td style="width: 10px; height: 10px;"></td><td style="width: 10px; height: 10px;"></td></tr> <tr><td style="width: 10px; height: 10px;"></td><td style="width: 10px; height: 10px;"></td><td style="width: 10px; height: 10px;"></td><td style="width: 10px; height: 10px;"></td></tr> <tr><td style="width: 10px; height: 10px;"></td><td style="width: 10px; height: 10px;"></td><td style="width: 10px; height: 10px;"></td><td style="width: 10px; height: 10px;"></td></tr> </table>														
Veal cutlet	1	3	200	5	8-10											
Lam cutlet	"	"	"	"	12-15											
Liver	"	"	"	"	10-12											
Chopped meat roulades	"	"	"	"	12-15											
Veal heart	"	"	"	"	12-15											
Roast in the net	"	"	"	"	20-25											
Half-chicken	-	"	"	"	20-25											
Fish fillet	-	"	"	"	12-15											
Stuffed tomatoes	-	"	"	"	10-12											

Caution: before any operation, disconnect electrically the oven.

General cleaning

To keep the characteristics of brightness of the enamelled parts for a long time it is necessary to clean the oven after each cooking. Once the oven is cold, you will be able to easily remove the fat deposits by means of a sponge or a cloth damp with warm soapy water and eventually a detergent to be found on the market. Never use abrasive cloths or sponges, that could irreparably damage the enamel. On white ovens even the parts of the dash board such as handgrip and knob have to be cleaned each time because they may become yellow due to the emissions of fat vapours. After the use, rinse thoroughly with water the parts in stainless steel and dry them with a soft cloth or with a bockskin. In case of persistent stain, use the normal non-abrasive cleaning agents or one of the specific products for stainless steel or some warm vinegar. Clean the door glass only with warm water, avoiding the use of rough cloths.

"Do not use jet of steam for cleaning."

Cleaning the oven door

Unhooking the doors.

1. Set the oven's door wide open.
2. Lift the hinge jumpers by your thumb and index fingers, then turn them fully outwards to the end of stroke (Fig.A).
3. Turn the door towards the closure position and lay it on the jumpers: in this way the hinge's spring results as blocked. By fully closing the door the hinges are unhooked from the connection slits which are integral with the oven's muffle (sequence 1,2,3 of fig.B).

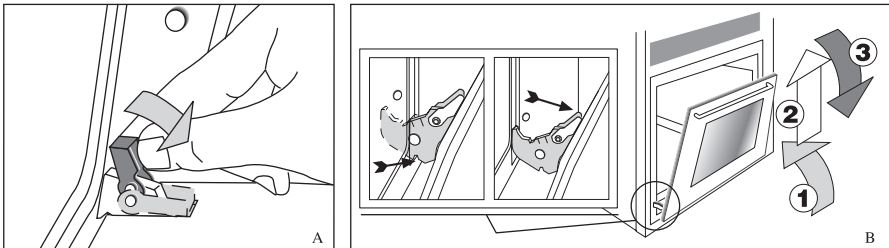

Hooking the doors

1. Insert the door by hooking the hinges to the connection slits set on the muffle front.
2. Fully open the door when inserted, then push and turn the cross connections which fasten the springs full scale in the oven direction.
3. Close the door and check its correct operation.

Replacing the oven bulb

Once the oven has been electrically disconnected, unscrew the glass protection cap and the bulb, replacing it with another one suitable for high temperatures (300°C / E14). Reassemble the glass cap and reconnect the oven.

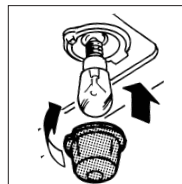

Furniture and technical data

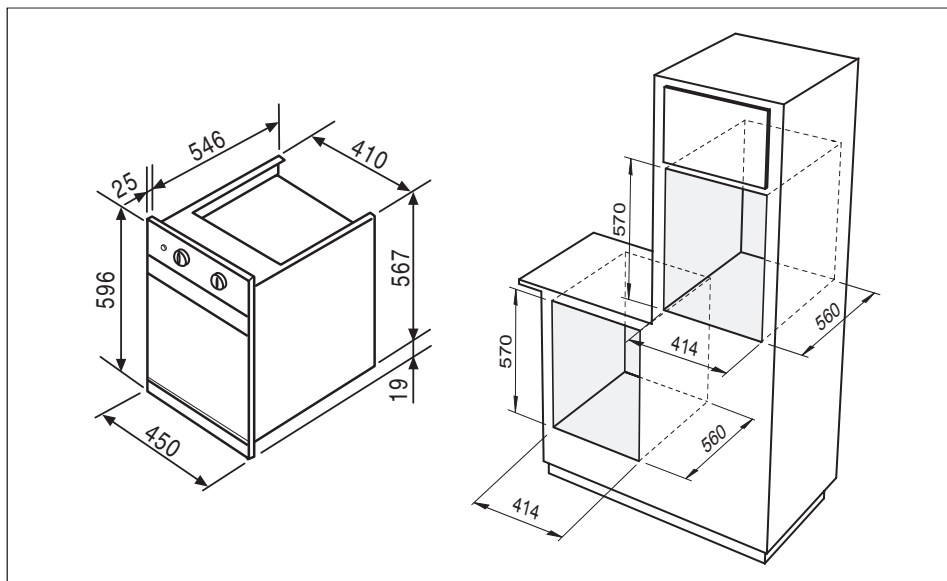

Working volume of the oven

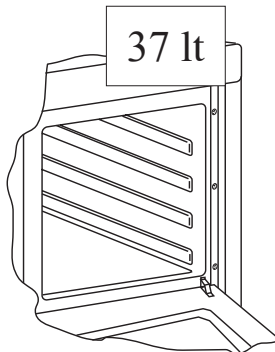

Electrical features	
Lighting bulb	max 25 W
Upper resistance	600 W
Lower resistance	800 W
Grill resistance	1400 W

Free Manuals Download Website

<http://myh66.com>

<http://usermanuals.us>

<http://www.somanuals.com>

<http://www.4manuals.cc>

<http://www.manual-lib.com>

<http://www.404manual.com>

<http://www.luxmanual.com>

<http://aubethermostatmanual.com>

Golf course search by state

<http://golfingnear.com>

Email search by domain

<http://emailbydomain.com>

Auto manuals search

<http://auto.somanuals.com>

TV manuals search

<http://tv.somanuals.com>