

FWV470

Manual for Installation, Use and Maintenance

|C|D|A|



Important

The CDA Group Ltd cannot be held responsible for injuries or losses caused by incorrect use or installation of this product. Please note that CDA reserve the right to invalidate the guarantee supplied with this product following incorrect installation or misuse of the appliance.

Under no circumstances should any external covers be removed for servicing or maintenance except by suitably qualified personnel.

Appliance information:

Please enter the details on the appliance rating plate below for reference, to assist CDA Customer Care in the event of a fault with your appliance and to register your appliance for guarantee purposes.

Appliance Model

Serial Number

CE Declarations of Conformity:

This appliance has been designed, constructed and marketed in compliance with safety requirements of EEC Directive 2006/95/EEC (Low voltage) and requirements of EMC Directive 2004/108/EEC.

This appliance has been manufactured to the strictest standards and complies with all applicable legislation, including Electrical safety (LVD) and Electromagnetic interference compatibility (EMC). Parts intended to come into contact with food conform to EEC/89/109.4

IMPORTANT INFORMATION FOR CORRECT DISPOSAL OF THE PRODUCT IN ACCORDANCE WITH EC DIRECTIVE 2002/96/EC.

At the end of its working life, the product must not be disposed of as urban waste. It must be taken to a special local authority differentiated waste collection centre or to a dealer providing this service.

Disposing of a household appliance separately avoids possible negative consequences for the environment and health deriving from inappropriate disposal and enables the constituent materials to be recovered to obtain significant savings in energy and resources. As a reminder of the need to dispose of household appliances separately, the product is marked with a crossed-out wheeled dust 

Please note:

This appliance is designed solely to produce ice cubes and dispense water. Other types of use are not permitted and may prove dangerous. The CDA Group Ltd will not be held liable for any damage caused by incorrect use of the appliance

- Read all instructions thoroughly before use.
- Before first use, you must allow the icemaker to settle for at least twenty four hours prior to switching the power on.
- To protect against fire, electrical shock and injury to persons do not immerse cord or plugs in water or other liquid.
- The use of accessory attachments not recommended by The CDA Group Ltd may result in fire, electric shock or injury.
- If the appliance is switched off, you should allow five minutes before switching it on again to prevent unnecessary damage to the compressor.
- You should only use cold drinking water in this appliance, with water hardness level less than 7F.

Icemaker

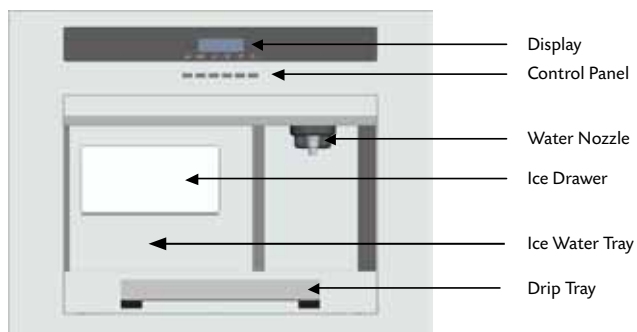

Icemaker control panel



1. On button
2. Off button
3. Water glass button – this button dispenses a small amount of water.
4. Water jug button – this button dispenses a large amount of water.
5. Manual water button – this button dispenses water as long as the button is pressed.
6. Settings button – this button changes the preset amounts of water.

The Icemaker

Before first use:

1. Pull the machine out of its housing by lifting the handle of the machine and pulling it towards you.
2. Turn on the machine at the power switch on the left side of the machine. The machine will automatically start a drain cycle, which will take approximately five minutes. During this process, the display will show **ICE OFF WATER EMPTY**.
3. Push the machine back into the housing.
4. Switch on the machine by pressing the  button.
5. The machine is now ready for use and the display shows **ICE ON WATER READY**.

Please note

You should clean the pipes through before first use to remove any impurities in the system after installation. To do so, place a jug under the water nozzle and press  for approximately two minutes, disposing of the water dispensed.

The Icemaker

To make ice

The icemaker will make ice automatically once it is switched on and will continue to make ice until the ice compartment is full. Whenever ice is removed, the icemaker will make more ice until the compartment is full again.

To dispense water







The amount of water dispensed from the water nozzle is controlled by three different buttons.

 – water glass

 – water jug

 – manual setting – this button dispenses water as long as the button is pressed.

To change the preset buttons

It is possible to adjust the amount of water dispensed by the preset buttons ( or ). To do so, place a glass or jug under the water nozzle and press  until the required amount has been dispensed. Then confirm the setting by pressing buttons  or  for the water glass button or buttons  or  for the water jug button.

Please note:

To stop water dispensing once a preset button has been pressed, simply press the button again.

The ice water tray is located below the ice drawer. In normal use this fills with water, this does not constitute a fault. This water is used in the ice making process and is replaced every 24 hours by the automatic drain cycle. You should use the water from the water nozzle for drinking.

The water nozzle is height adjustable for ease of use. To adjust the height, hold the black outer section of the water nozzle and raise or lower it to the height required. The nozzle will automatically remain at the height set.

To dispense ice

When the ice drawer is full, the display shows **ICE FULL WATER READY**.

Open the drawer fully and use the scoop provided to remove the ice as required.

Please note:

If the ice drawer is not emptied for a long period of time, the appliance will go on standby for approximately ten minutes, and the display shows **ICE OFF WATER READY**. After the standby period has ended, the appliance will begin to make ice again. If you do not want to wait for the standby period to finish, press the  button.

If the ice drawer is not emptied regularly an excessive accumulation of ice cubes could hinder the movement of the upper carriage. You are recommended to open the ice drawer slowly after a long period of time on standby and regularly remove ice cubes from the drawer.

Care and maintenance

Always disconnect the appliance from the power before any cleaning or maintenance.

As the icemaker has a stainless steel or enamel surface, you should use a nonabrasive cleaner. Any abrasive cleaner (including Cif) will scratch the surface and could erase the control panel markings. Stainless steel can be effectively cleaned by simply using a dilute solution of water and mild detergent and drying to a shine with a clean cloth.



Proprietary stainless steel cleaners are available. We recommend the CDA E-Cloth available from the CDA Sales Team for cleaning stainless steel surfaces.

You should remove and clean regularly the ice compartment drawer and both sections of the drip tray.

Once cleaning is complete, reconnect the mains power supply.

If the appliance is not to be used for prolonged periods of time, you should empty, clean thoroughly and turn off both the electricity and water supply.

To empty the icemaker, follow the steps below:

1. Press the **OFF** button
2. Empty the ice drawer
3. Press the **ON**,  and  buttons simultaneously.
4. The display will show **ICE OFF WATER EMPTY** for approximately five minutes until the cycle is complete.

IMPORTANT:

Steam cleaners must not be used when cleaning this appliance.

Ensure that all parts are correctly replaced after cleaning before attempting to use the icemaker.

You should replace the water filter every six months. Replacement filters are available from the CDA Sales Team.

Troubleshooting

Problem	Solution:
WATER MISSING shows in the display	Check the water supply is connected and switched on
ICE FAULT WATER READY shows in the display at first switch on	Turn the icemaker off with OFF , and the main switch on the side, before switching it on again.
The dispensed water has an unpleasant taste	Ensure that only water pipes suitable for drinking water are used
ICE FAULT shows in the display	Turn the icemaker off with OFF remove some ice and turn it on again. We recommend that the unit is not left on permanently.

IMPORTANT:

Do not operate with a damaged cord or plug, after the appliance malfunctions or has been damaged in any way. You should contact CDA Customer Care for inspection, repair or adjustment.

Installation

IMPORTANT: THIS APPLIANCE SHOULD BE FITTED BY SUITABLY QUALIFIED PERSON.

We recommend that you seek the assistance of another individual when installing this appliance.

This appliance requires a mains water supply and a connection to the drain/waste system (drain connection is not supplied)

1. Slide the base unit into the housing ensuring the dimensions are correct as per figure 1.
2. Fix the base unit in place by attaching the 10 screws in to the holes.
3. Push the runners fully closed on the base unit.
4. Connect the plug to the plug socket. This must be accessible after the appliance has been installed.
5. Using an appropriate supply pipe, connect one end of the hose to the threaded inlet of the valve on the dispenser, located at the rear of the appliance as shown in fig 3 and the other end to the mains supply tap outlet. This must be accessible after the appliance has been installed.
6. Install the inline filter

- Locate a convenient position to install the filter (C), remembering that it must be accessible when it is to be changed and functions best when mounted vertically.
- Screw the filter bracket (E) to the cupboard wall using screws (D), if attaching the bracket to an interior wall use rawl plugs also.
- Remove the dust caps from the ends of the filter (C) and write the installation date onto its label. Firmly push the pushfit connectors (B and F) onto each end of the filter.
- Clip the filter (C) into its bracket (E) noting the direction of flow through the filter (C) towards the ice maker.
- Cut the flexible pipe (A) so it is slightly longer than the required lengths to and from the filter unit (C). When cutting the pipe use a sharp Stanley knife, ensuring that the pipe is cut cleanly and square at all ends.
- Firmly push the pipe (A) apx. 12mm into the pushfit connector (B).
- Screw the large pushfit adaptor (G) onto the 3 way tee (H)
- Firmly push the pipe (A) apx. 12mm into the pushfit connector (F) and push fit adaptor (G).

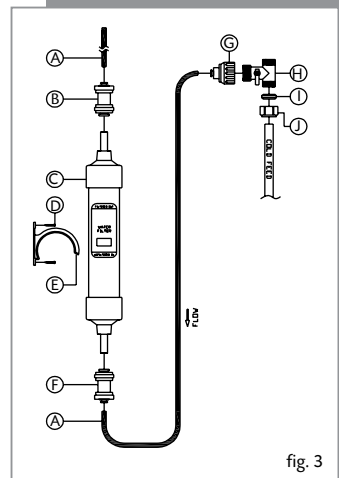
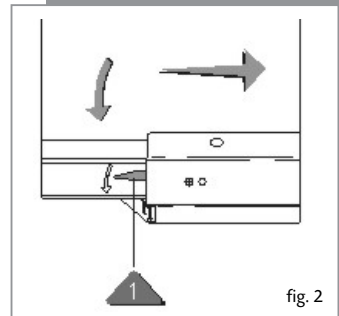
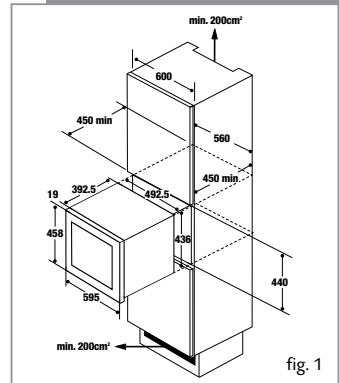

7. Connect the drain pipe as shown in fig 6 and the other end to an appropriate drain, for example a laundry standpipe or under sink spigot . Drain connections to the plumbing side are not supplied.

8. Insert the appliance into the housing, ensuring that the runners on the machine are located in the runners on the base unit. Then slide the appliance fully into the housing.

Please note:

Due to the weight of this appliance, the housing unit must be secured to the wall prior to installation.

You must ensure that all water connections are sound and check there are no leaks and check the drain is in place, before completing installation.

For best performance, the mains water pressure must be between 0.1 - 3 bar.

Do not use outdoors.

Do not locate the drain outdoors.

Do not install near a hob or oven.

To reduce the risk of electric shock, do not mount over a sink.

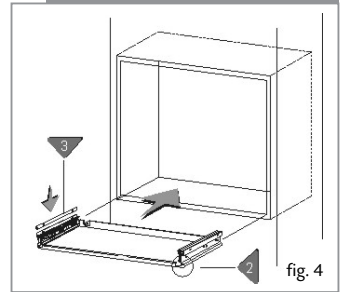

fig. 4

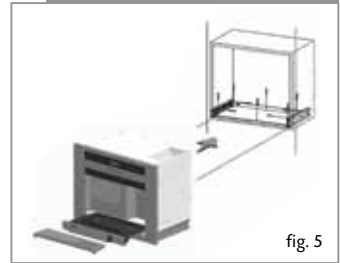

fig. 5

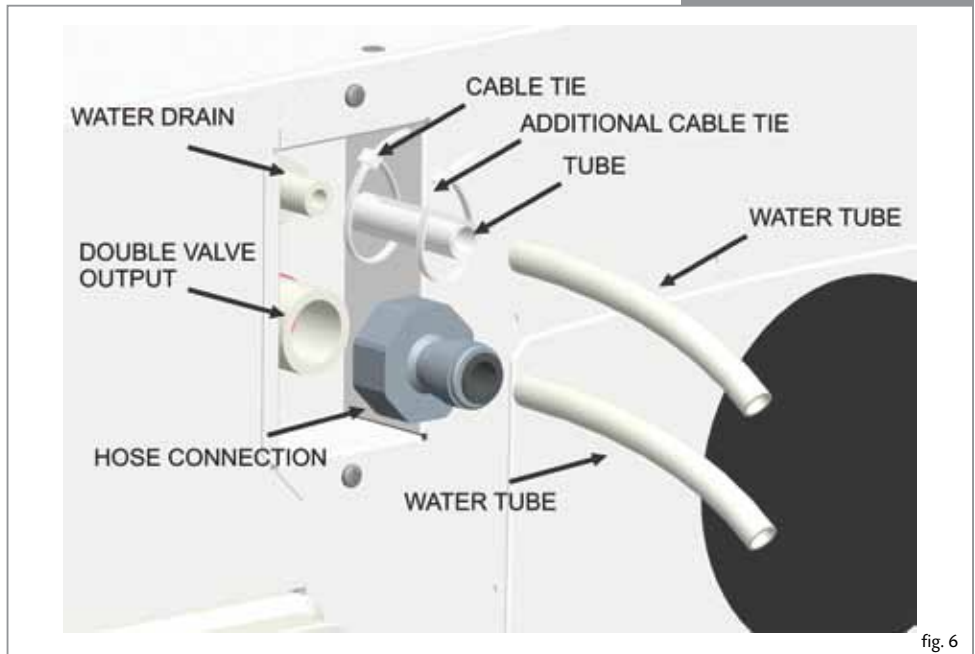
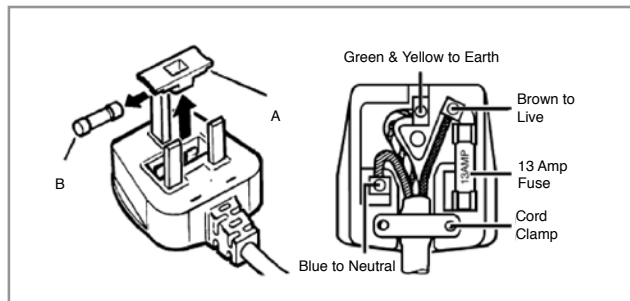

fig. 6

Electrical information

Warning! This appliance must be earthed.



The mains lead of this appliance has been fitted with a BS 1363A 13 amp fused plug. To change a fuse in this type of plug, follow the steps below:

1. Remove the fuse cover and fuse.
2. Fit replacement 13A fuse, ASTA approved to BS 1362 type, into the fuse cover.
3. Replace fuse cover.

Important: Do not use the appliance without the fuse cover in position.

How to connect an alternative plug

If the fitted plug is not suitable for your socket outlet, then it should be cut off and disposed of safely to avoid the risk of electric shock. A suitable alternative plug of at least 13 Amp rating to BS 1363 should be used.

As the colours of the wires in the mains lead of this appliance may not correspond with the coloured markings identifying the terminals in your plug, proceed as follows:-

- The wire which is coloured GREEN and YELLOW must be connected to the terminal which is marked with letter (E) or by the Earth symbol \perp or coloured GREEN and YELLOW.
- The wire which is coloured BLUE must be connected to the terminal which is marked with the letter (N), or coloured BLACK.
- The wire which is coloured BROWN must be connected to the terminal which is marked with the letter (L) or coloured RED or BROWN.

If in doubt regarding the electrical connection of this appliance, consult a qualified electrician. Do not shorten the supply cable, the appliance may require removing for servicing.

N.B. Ensure that the plug socket is situated in an easily accessible place after installation.





To contact our Customer Care Department, or for Service,
please contact us on the details below.

Free Manuals Download Website

<http://myh66.com>

<http://usermanuals.us>

<http://www.somanuals.com>

<http://www.4manuals.cc>

<http://www.manual-lib.com>

<http://www.404manual.com>

<http://www.luxmanual.com>

<http://aubethermostatmanual.com>

Golf course search by state

<http://golfingnear.com>

Email search by domain

<http://emailbydomain.com>

Auto manuals search

<http://auto.somanuals.com>

TV manuals search

<http://tv.somanuals.com>