



INLINE FANS

JACK OF
all TRADES



**MID
MIXED FLOW
FAN**

- High capacity 'MF' mixed flow impellers
- Exceptionally quiet and efficient
- 'AMCA B' spark resistant construction
- Multiple blade settings available
- Exact performance matching
- Custom mounting arrangements available
- Standard NEMA motors
- Capacities to 20,000 cfm

AID MULTILINE

- quiet and efficient **axial flow** impeller
- best for high flows, low to moderate pressures
- adjustable pitch for exact performance matching
- cast aluminum hub, steel taperlock bushing
- choice of 5 or 10 blades in GRP or aluminum
- spark resistant construction

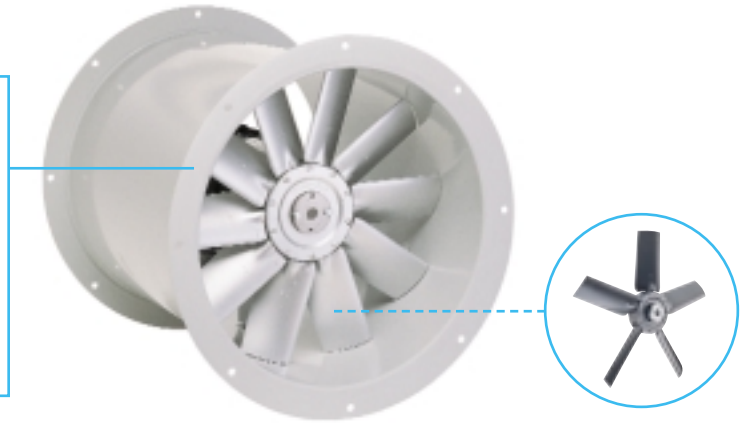

MID MULTILINE

- unique adjustable pitch **mixed flow** impeller
- moderate airflows, medium to high pressures
- quiet performance; stall resistant at high pressures
- more compact than inline centrifugals
- aluminum impeller; steel taperlock bushing
- spark resistant construction

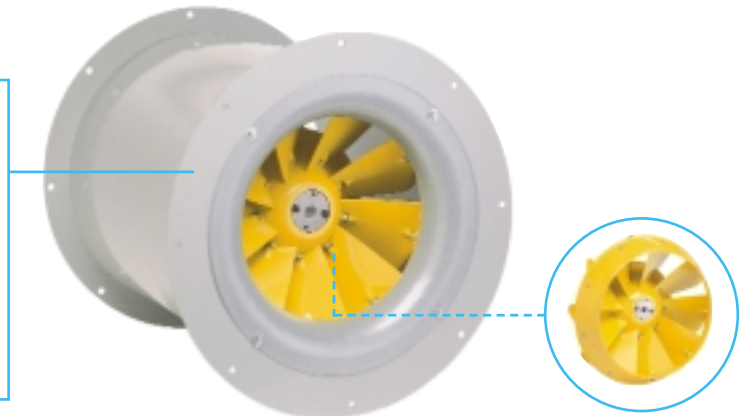

TID MULTILINE

- backward curved airfoil **centrifugal** impeller
- best for lower flows, medium to high pressures
- extremely quiet and efficient
- stall resistant even at shutoff
- rugged glass reinforced polyamide impeller
- spark resistant construction

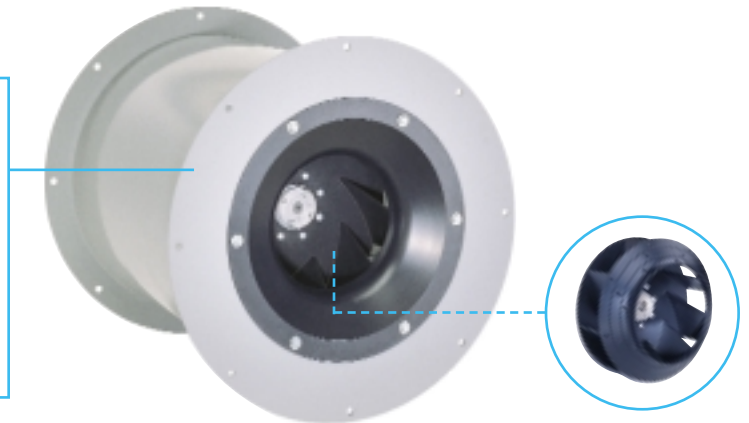

8 HOLES 7/16" DIA.

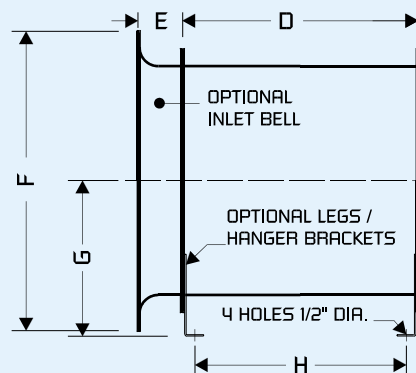
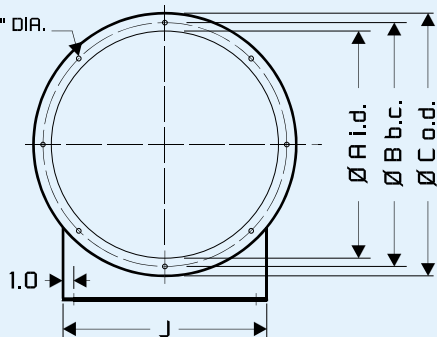

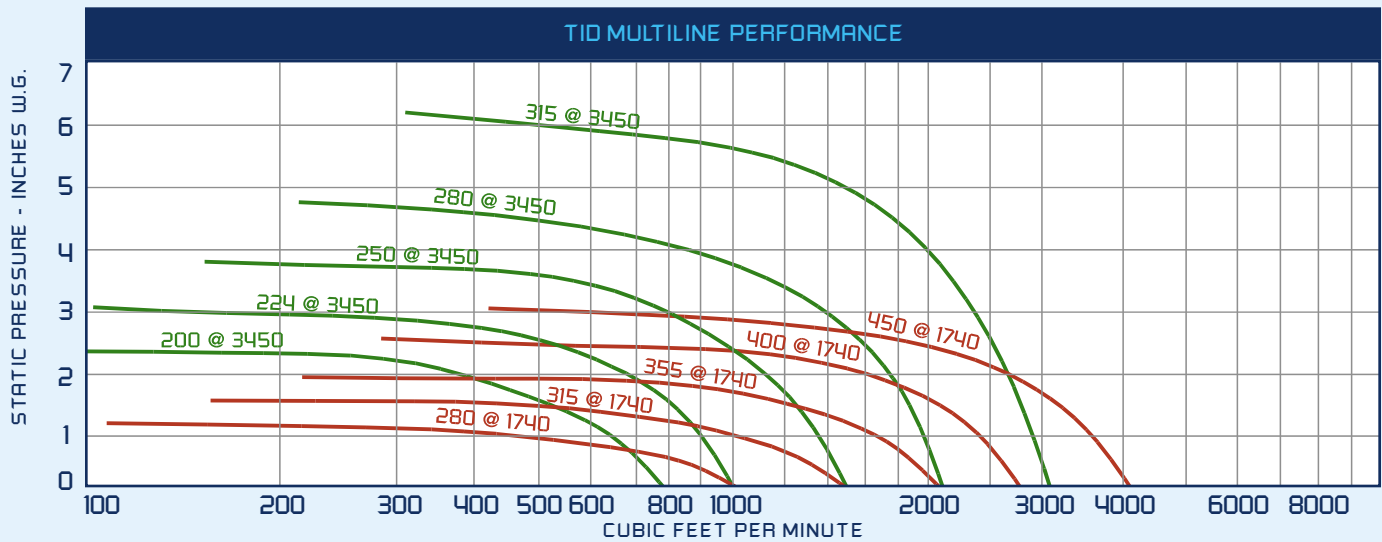
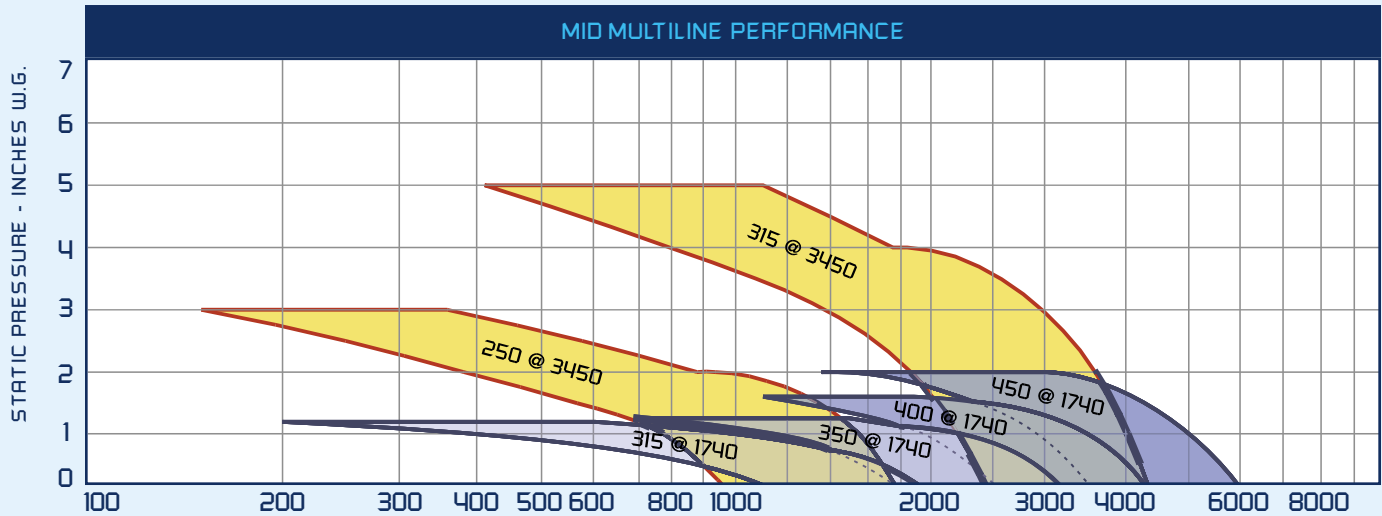
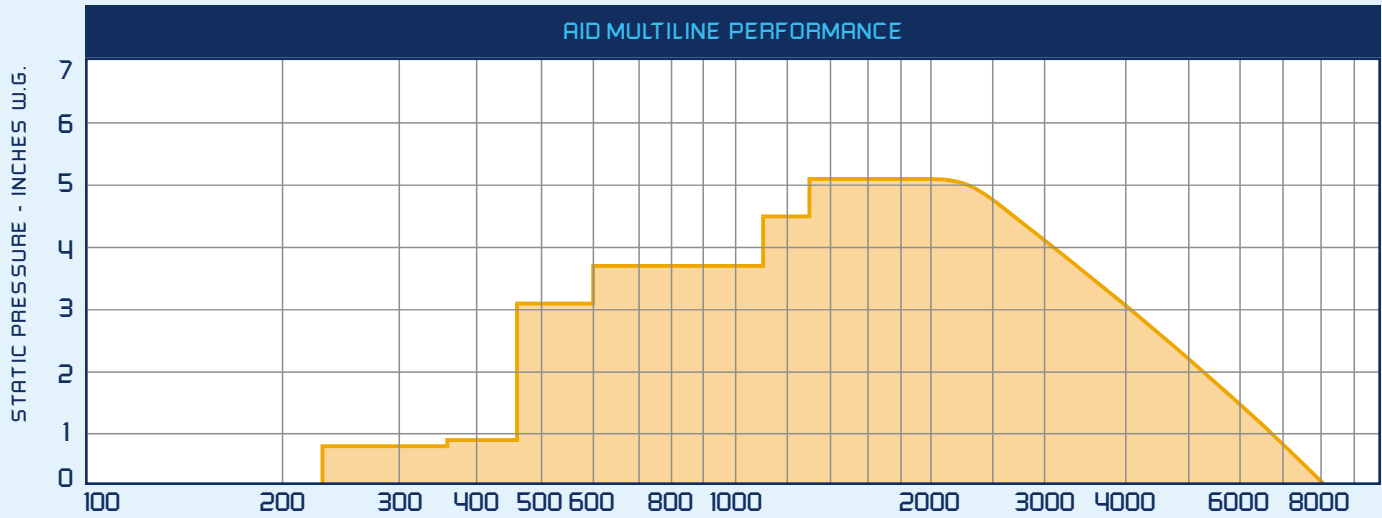

AID MULTILINE	MID MULTILINE	TID MULTILINE	DIMENSION IN INCHES								
			A	B	C	D	E	F	G	H	J
AID120	MID250	TID200	12.19	13.75	15.0	18.0	2.5	18.5	9.5	16.0	12.0
AID140	-	TID224 / TID250	14.19	16.25	17.5	20.0	2.5	19.5	10.0	18.0	14.0
AID160	MID315	TID280	16.19	18.0	19.5	21.0	3.0	22.5	11.5	19.0	16.0
AID180	MID350	TID315	18.19	20.75	22.0	24.0	3.5	24.5	12.5	22.0	17.0
AID210	MID400	TID355	21.19	23.25	24.5	26.0	4.0	28.0	14.5	24.0	19.0
AID240	MID450	TID400 / TID450	24.19	26.25	27.5	29.0	4.0	30.5	15.5	27.0	21.0



MID MULTILINE PERFORMANCE

1740 RPM

SIZE	PEAK HP	MTR. HP	dBA @5ft	CUBIC FEET PER MINUTE										
				0" SP	1/4" SP	1/2" SP	3/4" SP	1" SP	1 1/4"SP	1 1/2"SP	1 3/4"SP	2" SP	2 1/4"SP	2 1/2"SP
315-1	0.20	1/4	61	1190	1050	890	650	360						
315-2	0.23	1/4	62	1390	1260	1080	840	540						
315-3	0.31	1/3	64	1630	1470	1300	1050	720						
315-4	0.39	1/2	65	1830	1680	1490	1250	870						
315-5	0.49	1/2	65	2020	1870	1680	1400	924						
350-1	0.34	1/2	61	1850	1720	1570	1390	1110	690					
350-2	0.43	1/2	62	2180	2050	1890	1690	1410	980					
350-3	0.53	1/2	65	2540	2390	2190	2010	1700	1290					
350-4	0.67	3/4	66	2930	2770	2580	2350	2050	1500					
350-5	0.86	1	66	3280	3110	2900	2620	2230						
400-1	0.64	3/4	68	2630	2480	2310	2140	1930	1640	1260	700			
400-2	0.82	1	69	3150	3010	2780	2560	2320	2040	1540	960			
400-2	1.02	1	70	3590	3410	3220	3020	2740	2440	1990	1170			
400-4	1.23	1.5	73	4030	3840	3620	3390	3140	2830	2280	1340			
400-5	1.45	1.5	73	4380	4200	4000	3780	3490	3140	2410				
450-1	0.97	1	70	3600	3460	3300	3110	2900	2670	2350	1950	1360	970	
450-2	1.27	1.5	72	4470	4280	4060	3870	3630	3360	3000	2590	1960	1320	
450-3	1.58	1.5	73	5340	5130	4900	4640	4360	4060	3650	3170	2440	1670	
450-4	2.06	2	74	6130	5890	5630	5340	5050	4710	4270	3740	2850		

3450 RPM

SIZE	PEAK HP	MTR. HP	dBA @5ft	CUBIC FEET PER MINUTE										
				0" SP	1/4" SP	1/2" SP	3/4" SP	1" SP	1 1/2"SP	2" SP	2 1/2"SP	3" SP	4" SP	5" SP
250-1	0.46	1/2	72	990	950	900	840	770	570	380	250	150		
250-2	0.49	1/2	71	1260	1220	1160	1090	1010	810	570	390	240		
250-3	0.52	1/2	71	1460	1410	1360	1300	1220	1000	730	500	300		
250-4	0.64	3/4	72	1640	1590	1530	1460	1360	1190	870	580	360		
250-5	0.79	1	72	1800	1750	1700	1630	1550	1300	930				
315-1	1.94	2	80	2470	2410	2340	2270	2200	2060	1860	1630	1330	790	410
315-2	2.21	2	81	2970	2900	2830	2750	2660	2490	2290	2080	1770	1090	570
315-3	2.50	3	82	3460	3390	3310	3230	3150	2980	2770	2530	2230	1440	770
315-4	3.09	3	83	3910	3640	3760	3670	3580	3400	3180	2930	2610	1750	1100



TID MULTILINE PERFORMANCE

1740 RPM

SIZE	PEAK HP	MTR. HP	dBA @5ft	CUBIC FEET PER MINUTE										
				0" SP	1/4" SP	1/2" SP	3/4" SP	1" SP	1 1/4"SP	1 1/2"SP	1 3/4"SP	2" SP	2 1/2"SP	3" SP
280	0.16	1/4	62	1080	990	880	700	450						
315	0.34	1/2	67	1570	1460	1350	1210	1020	790	490				
355	0.65	3/4	72	2160	2050	1940	1820	1670	1480	1240	940			
400	1.23	1 1/2	73	2850	2750	2640	2530	2410	2270	2090	1840	1610	410	
450	1.82	2	74	4220	4070	3920	3760	3590	3400	3190	2900	2660	1900	590

3450 RPM

SIZE	PEAK HP	MTR. HP	dBA @5ft	CUBIC FEET PER MINUTE										
				0" SP	1/2" SP	1" SP	1 1/2"SP	2" SP	2 1/2"SP	3" SP	3 1/2"SP	4" SP	5" SP	6" SP
200	0.24	1/3	68	810	740	650	520	380						
224	0.44	1/2	73	1020	960	900	810	690	520	140				
250	0.66	3/4	75	1530	1450	1360	1260	1120	960	790	510			
280	1.41	1 1/2	77	2140	2060	1980	1870	1750	1590	1390	1140	850		
315	2.58	3	82	3130	3020	2910	2790	2660	2520	2360	2160	1990	1490	500

AEROFANS



- OEM & Industrial Applications
- Compact, Powerful & Quiet
- Optimized for Sound & Efficiency
- 7 Sizes, 12" - 27"

MULTILINE FANS



- Axial, Centrifugal or Mixed Flow
- Epoxy Coated Steel Housings
- Up to 9000 cfm, 6" w.g.
- 6 Sizes, 12" - 24" dia.

TCD BLOWERS



- OEM & Industrial Applications
- Ultra Quiet, Efficient & Compact
- Corrosion & Spark Resistant
- 8 Sizes, 7⁷/₈" - 17³/₄" wheel dia.

TEK IMPELLERS



- OEM Applications
- Quiet & Efficient Airfoil Blades
- Glass Reinforced Polyamide
- 9 Sizes, 7" - 17³/₄" dia.

ELTA IMPELLERS



- OEM & Replacement Applications
- GFR or Aluminum Adjustable Blades
- Optimized for Sound & Efficiency
- all diameters, 12" - 78"

TMK IMPELLERS



- OEM Applications
- Quiet & Efficient Airfoil Blades
- Integral Motor; Space Saving Design
- 5 Sizes, Capacities to 5000 cfm

IRIS DAMPERS



- Control & Measure Airflow
- Simplify & Verify Air Balancing
- Compact, Rugged & Precise
- 10 Sizes, 4" - 32"

MOTORIZED IMPELLERS



- OEM Applications
- Ultra Compact, Quiet & Efficient
- Speed Controllable
- 4 Sizes, Capacities to 1000 cfm

AXG FANS



- Compact & Powerful
- Very Quiet, Efficient & Durable
- Speed Controllable
- 11 Sizes, 4" - 12", 1100 cfm Capacity

USA

www.continentalfan.com

Continental Fan Manufacturing Inc.
203 Eggert Road
Buffalo, New York 14215
Tel: (800) 779 4021 Fax: (716) 842 0611

Canada

www.aeroflo.com

Aeroflo Inc.
205 Matheson Blvd. East, Unit #12
Mississauga, Ontario L4Z 3E3
Tel: (905) 890 6192 Fax: (905) 890 6193

Free Manuals Download Website

<http://myh66.com>

<http://usermanuals.us>

<http://www.somanuals.com>

<http://www.4manuals.cc>

<http://www.manual-lib.com>

<http://www.404manual.com>

<http://www.luxmanual.com>

<http://aubethermostatmanual.com>

Golf course search by state

<http://golfingnear.com>

Email search by domain

<http://emailbydomain.com>

Auto manuals search

<http://auto.somanuals.com>

TV manuals search

<http://tv.somanuals.com>