



AstroMaster Series Telescopes

INSTRUCTION MANUAL

- AstroMaster 70AZ # 21061
- AstroMaster 90AZ # 21063
- AstroMaster 114AZ # 31043

Table of Contents

INTRODUCTION	3
ASSEMBLY	6
Setting up the Tripod	6
Moving the Telescope Manually	7
Attaching the Telescope Tube to the Mount.....	7
Installing the Diagonal & Eyepieces (refractor)	8
Installing the Eyepieces on the Newtonians	8
TELESCOPE BASICS	9
Image Orientation	10
Focusing.....	10
Aligning the Finderscope	10
Calculating Magnification	11
Determining Field of View	12
General Observing Hints.....	12
ASTRONOMY BASICS	13
The Celestial Coordinate System.....	13
Motion of the Stars.....	14
CELESTIAL OBSERVING	15
Observing the Moon	15
Observing the Planets	15
Observing the Sun.....	15
Observing Deep Sky Objects	16
Seeing Conditions	18
ASTROPHOTOGRAPHY	19
Short Exposure Prime Focus Photography	19
Piggyback Photography	19
Planetary & Lunar Photography with Special Imagers.....	19
CCD Imaging for Deep Sky Objects	19
Terrestrial Photography	19
TELESCOPE MAINTENANCE.....	20
Care and Cleaning of the Optics	20
Collimation of a Newtonian.....	20
OPTIONAL ACCESSORIES	23
AstroMaster Specifications.....	24

Introduction

Congratulations on your purchase of an AstroMaster Series telescope. The AstroMaster Series of telescopes come in several different models and this manual covers three models mounted on the Alt-AZ Mount ((an altazimuth is the simplest type of mount with two motions – altitude (up & down) and azimuth (side-to-side)))-- 70mm refractor, 90mm refractor, and 114mm Newtonian. The AstroMaster Series is made of the highest quality materials to ensure stability and durability. All this adds up to a telescope that gives you a lifetime of pleasure with a minimal amount of maintenance.

These telescopes were designed for the First Time Buyer offering exceptional value. The AstroMaster series features a compact and portable design with ample optical performance to excite any newcomer to the world of amateur astronomy. In addition, your AstroMaster telescope is ideal for terrestrial observations which will open your eyes with superb high power viewing.

AstroMaster telescopes carry a **two year limited warranty**. For details see our website at www.celestron.com

Some of the many standard features of the AstroMaster include:

- All coated glass optical elements for clear, crisp images.
- Smooth functioning, rigid alt-azimuth mount with a large pan handle with built-in clutch for easy targeting.
- Preassembled steel leg tripod with 1.25” legs ensures stable platform.
- Quick and easy no-tool set up.
- CD-ROM “The Sky” Level 1 --- astronomy software which provides education about the sky and printable sky maps.
- All models can be used terrestrially as well as astronomically with the standard accessories included.

Take time to read through this manual before embarking on your journey through the Universe. It may take a few observing sessions to become familiar with your telescope, so you should keep this manual handy until you have fully mastered your telescope’s operation. The manual gives detailed information regarding each step as well as needed reference material and helpful hints guaranteed to make your observing experience as simple and pleasurable as possible.

Your telescope is designed to give you years of fun and rewarding observations. However, there are a few things to consider before using your telescope that will ensure your safety and protect your equipment.

Warning



- **Never look directly at the sun with the naked eye or with a telescope (unless you have the proper solar filter). Permanent and irreversible eye damage may result.**
- **Never use your telescope to project an image of the sun onto any surface. Internal heat build-up can damage the telescope and any accessories attached to it.**
- **Never use an eyepiece solar filter or a Herschel wedge. Internal heat build-up inside the telescope can cause these devices to crack or break, allowing unfiltered sunlight to pass through to the eye.**
- **Do not leave the telescope unsupervised, either when children are present or adults who may not be familiar with the correct operating procedures of your telescope.**

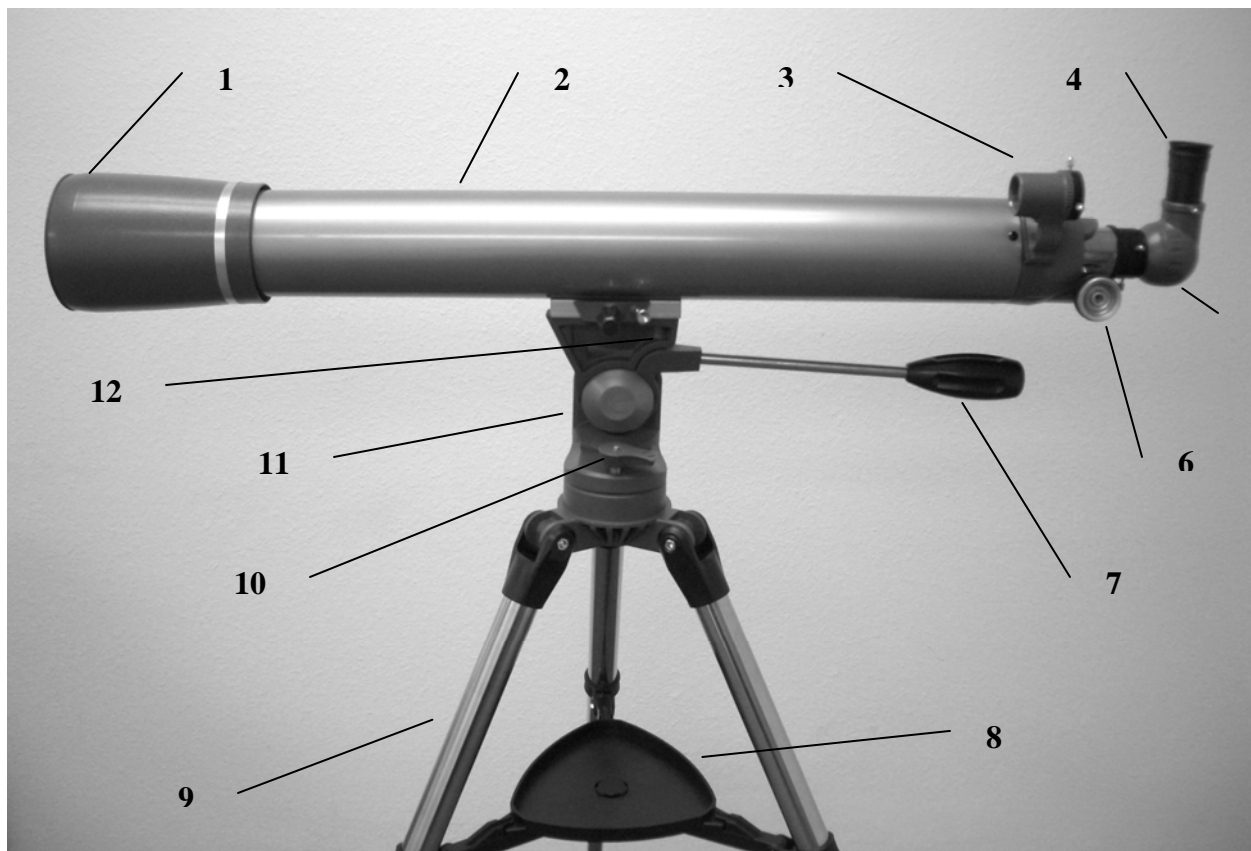

**Figure 1-1 AstroMaster 90AZ Refractor
(AstroMaster 70AZ refractor similar)**

1.	Objective Lens	7.	Pan Handle
2.	Telescope Optical Tube	8.	Accessory Tray
3.	Star Pointer Finderscope	9.	Tripod
4.	Eyepiece	10.	Azimuth Lock
5.	Diagonal	11.	Alt-Az Mount
6.	Focus Knob	12.	Dovetail Mounting Bracket

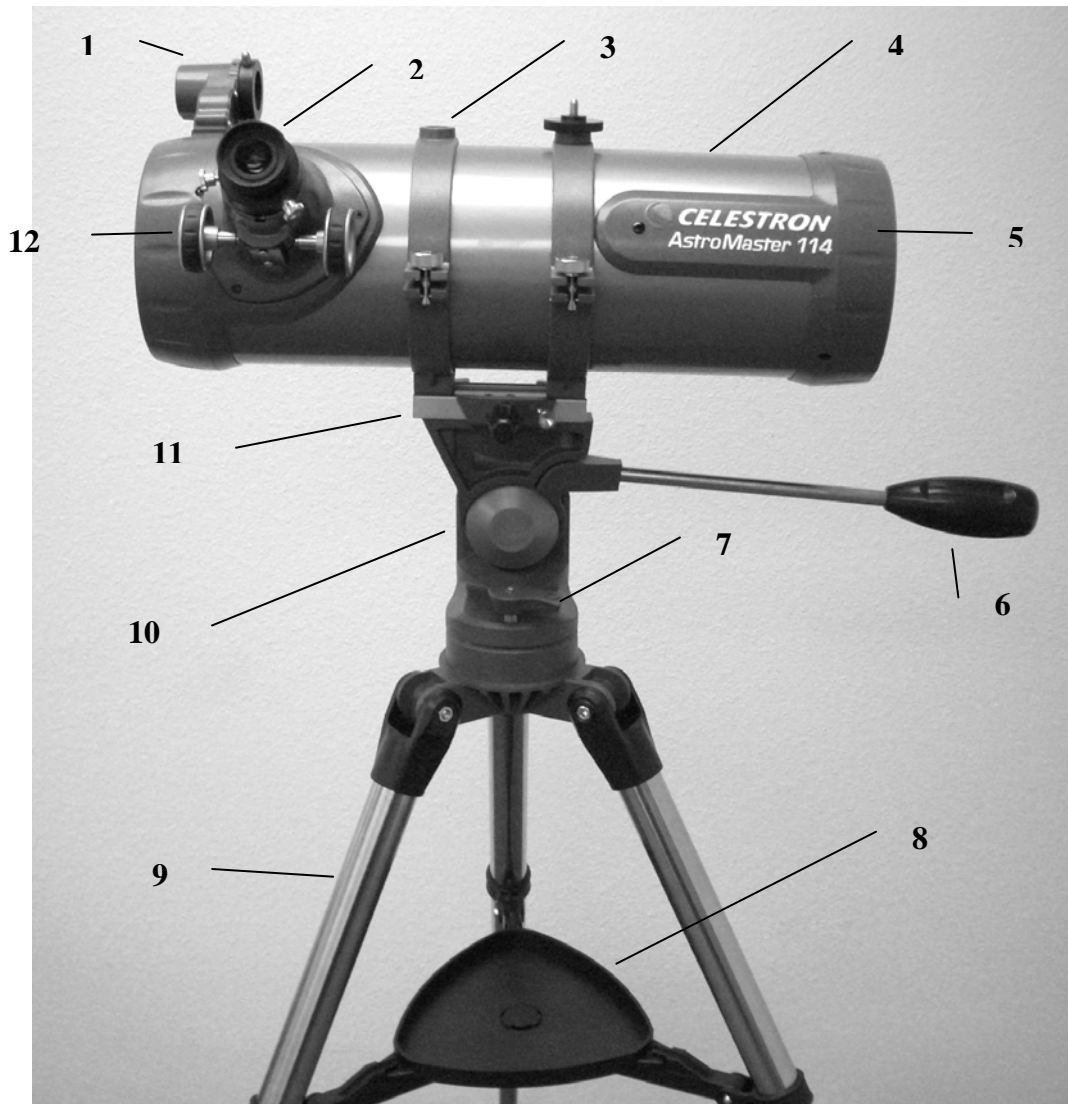

Figure 1-2 AstroMaster 114 AZ Newtonian

1.	Star Pointer Finderscope	7.	Azimuth Lock
2.	Eyepiece	8.	Accessory Tray
3.	Tube Ring	9.	Tripod
4.	Telescope Optical Tube	10.	Alt-Az Mount
5.	Primary Mirror	11.	Dovetail Mounting Bracket
6.	Pan Handle	12.	Focus Knob

Assembly

This section covers the assembly instructions for your AstroMaster telescope. Your telescope should be set up indoor the first time so that it is easy to identify the various parts and familiarize yourself with the correct assembly procedure before attempting it outdoor.

Each AstroMaster comes in one box. The pieces in the box are – optical tube with attached sky pointer and tube rings (114 AZ only), Alt-Az mount with attached pan handle, 10mm eyepiece – 1.25”, 20mm eyepiece – 1.25” (erect image for 114AZ), erect image diagonal 1.25” (for 70AZ and 90 AZ), “The Sky” Level 1 CD-ROM.

Setting up the Tripod

1. Remove the tripod from the box (Figure 2-1). The tripod comes preassembled so that the set up is very easy.
2. Stand the tripod upright and pull the tripod legs apart until each leg is fully extended and then push down slightly on the tripod leg brace (Figure 2-2). The very top of the tripod is called the tripod head.
3. Next, we will install the tripod accessory tray (Figure 2-3) onto the tripod leg brace (center of Figure 2-2).
4. Insert the cut-out in the center of the tray (flat side of the tray facing down) to match the center of the tripod leg brace and push down slightly (Figure 2-4). The ears of the tray should appear as in Figure 2-4



Figure 2-1



Figure 2-2



Figure 2-3



Figure 2-4

5. Rotate the tray until the ears are under the leg brace support of each leg and push slightly and they will lock in place (Figure 2-5). The tripod is now completely assembled (Figure 2-6).
6. You can extend the tripod legs to the height you desire. At the lowest level the height is 24” (61cm) and extends to 41” (104cm). You unlock the tripod leg lock knob at the bottom of each leg (Figure 2-7) and pull the legs out to the height you want & then lock the knob securely. A fully extended the tripod looks like the image in Figure 2-8.
7. The tripod will be the most rigid and stable at the lowest height.



Figure 2-5



Figure 2-6



Figure 2-7



Figure 2-8

Moving the Telescope Manually

The AstroMaster Alt-Az mount is easy to move wherever you want to point it. The up and down (altitude) is controlled by the pan handle (Figure 2-10). The side-to-side (azimuth) is controlled by the azimuth lock (Figure 2-9). The pan handle and the azimuth lock are both loosened by turning the handle and lock counterclockwise. When loose you can find your objects easily and then lock the controls. To lock the controls in place, turn them clockwise.



Figure 2-9



Figure 2-10

Attaching the Telescope Tube to the Mount

The telescope optical tube attaches to the mount via a dovetail slide bar mounting bracket at the top of the mount (Figure 2-11). For the 114 AZ Newtonian, the mounting bar is the bracket which is attached to the tube rings. For the 70AZ and 90AZ refractors the mounting bar is attached along the bottom of the telescope tube. **Before you attach the optical tube, make sure that the pan handle and azimuth lock are fully locked.** Then put the dovetail bracket in the horizontal position as shown in Figure 2-10. This will ensure that the mount does not move suddenly while attaching the telescope optical tube. Also, remove the objective lens cap (refractor) or the front opening cap (Newtonian). To mount the telescope tube:

- 1 Remove the protective paper covering the optical tube. You will have to remove the tube rings on the 114EQ Newtonian before removing the paper.
- 2 Loosen the mounting knob and the mounting safety screw on the side of the dovetail mounting platform so they do not protrude into the mounting platform – see Figure 2-18.
- 3 Slide the dovetail mounting bar into the recess on the top of the mounting platform (figure 2-17).
- 5 Tighten the mounting knob on the dovetail mounting platform to hold the telescope in place.
- 6 Hand tighten the mounting platform safety screw until the tip touches the side of the mounting bracket.

NOTE: Never loosen any of the knobs on the telescope tube or mount other than the R.A. and DEC knobs.



Figure 2-11

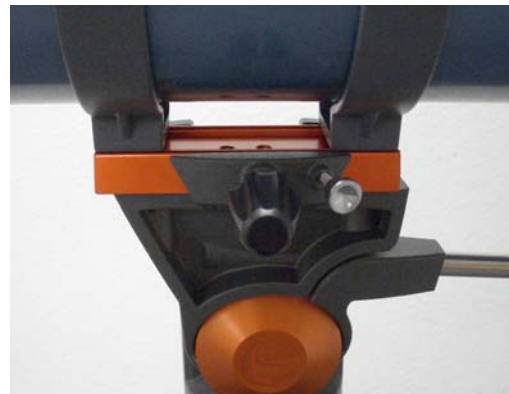

Figure 2-12 Mounting Knob & Safety Screw in the dovetail bracket. Shown is the 90AZ telescope tube

Installing the Diagonal & Eyepieces (refractor)

The diagonal is a prism that diverts the light at a right angle to the light path of the refractor. This allows you to observe in a position that is more comfortable than if you looked straight through. This diagonal is an erect image model that corrects the image to be right side up and oriented correctly left-to-right which is much easier to use for terrestrial observing. Also, the diagonal can be rotated to any position which is most favorable for you. To install the diagonal and eyepieces:

1. Insert the small barrel of the diagonal into the 1.25" eyepiece adapter of the focus tube on the refractor – Figure 2-13. Make sure the two thumbscrews on the eyepiece adapter do not protrude into the focuser tube before installation and the plug up cap is removed from the eyepiece adapter.
2. Put the chrome barrel end of one of the eyepieces into the diagonal and tighten the thumb screw. Again, when doing this make sure the thumb screw is not protruding into the diagonal before inserting the eyepiece.
3. The eyepieces can be changed to other focal lengths by reversing the procedure in step 2 above.



Figure 2-13

Installing the Eyepieces on the Newtonians

The eyepiece (or ocular) is an optical element that magnifies the image focused by the telescope. Without the eyepiece it would be impossible to use the telescope visually. Eyepieces are commonly referred to by focal length and barrel diameter. The longer focal length (i.e., the larger the number) the lower the eyepiece magnification (i.e., power). Generally, you will use low-to-moderate power when viewing. For more information on how to determine power, see the section on "Calculating Magnification". The eyepiece fits directly into the focuser of the Newtonians. To attach the eyepieces:

1. Make sure the thumbscrews are not protruding into the focuser tube. Then, insert the chrome barrel of the eyepieces into the focus tube (remove the plug up cap of the focuser first) and tighten the thumbscrews – see Figure 2-14.
2. The 20mm eyepiece is called an erecting eyepiece since it corrects the image so it is right side up and corrected left to right. This makes the telescope useful for terrestrial viewing.
3. The eyepieces can be changed by reversing the procedure as described above.



Figure 2-14

CELESTRON Telescope Basics

A telescope is an instrument that collects and focuses light. The nature of the optical design determines how the light is focused. Some telescopes, known as refractors, use lenses, and other telescopes, known as reflectors (Newtonians), use mirrors.

Developed in the early 1600s, the **refractor** is the oldest telescope design. It derives its name from the method it uses to focus incoming light rays. The refractor uses a lens to bend or refract incoming light rays, hence the name (see Figure 3-1). Early designs used single element lenses. However, the single lens acts like a prism and breaks light down into the colors of the rainbow, a phenomenon known as chromatic aberration. To get around this problem, a two-element lens, known as an achromat, was introduced. Each element has a different index of refraction allowing two different wavelengths of light to be focused at the same point. Most two-element lenses, usually made of crown and flint glasses, are corrected for red and green light. Blue light may still be focused at a slightly different point.

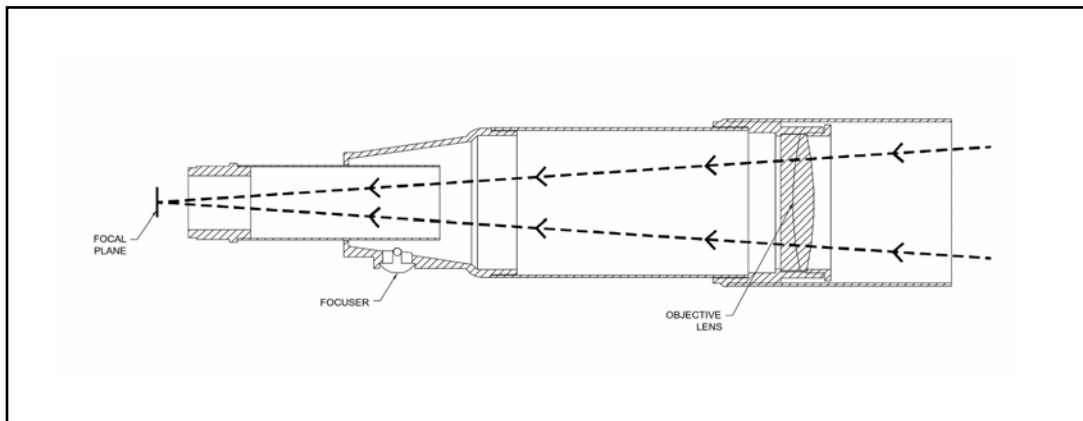

Figure 3-1
A cutaway view of the light path of the Refractor optical design

A **Newtonian** reflector uses a single concave mirror as its primary. Light enters the tube traveling to the mirror at the back end. There light is bent forward in the tube to a single point, its focal point. Since putting your head in front of the telescope to look at the image with an eyepiece would keep the reflector from working, a flat mirror called a *diagonal* intercepts the light and points it out the side of the tube at right angles to the tube. The eyepiece is placed there for easy viewing.

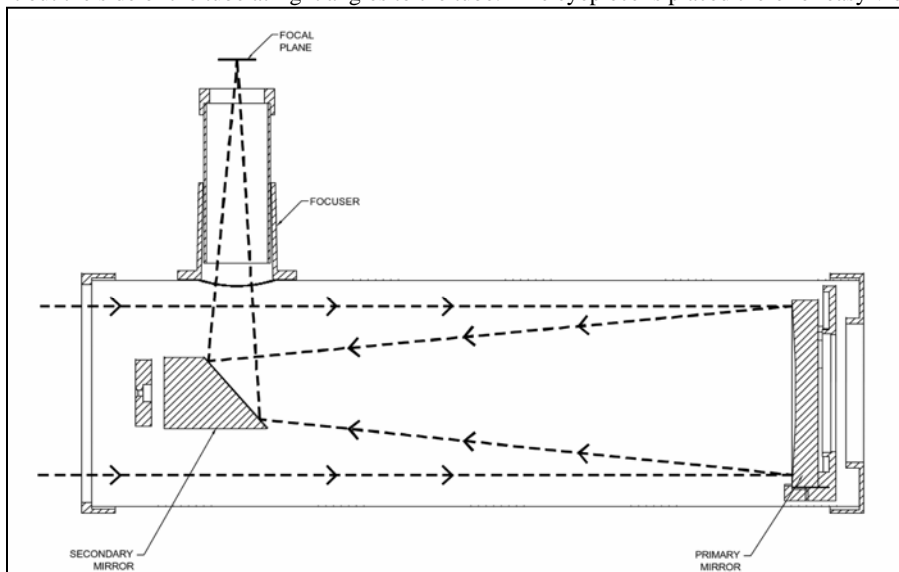

Figure 3-2
Cutaway view of the light path of the Newtonian optical design

Newtonian Reflector telescopes replace heavy lenses with mirrors to collect and focus the light, providing much more light-gathering power for the money spent. Because the light path is intercepted and reflected out to the side, you can have focal lengths up to 1000mm and still enjoy a telescope that is relatively compact and portable. A Newtonian Reflector telescope offers such impressive light-gathering characteristics you can take a serious interest in deep space astronomy even on a modest budget. Newtonian Reflector telescopes do require more care and maintenance because the primary mirror is exposed to air and dust. However, this small drawback does not hamper this type of telescope's popularity with

those who want an economical telescope that can still resolve faint, distant objects.

Image Orientation

The image orientation changes depending on how the eyepiece is inserted into the telescope. When using a star diagonal with refractors, the image is right-side-up, but reversed from left-to-right (i.e., mirror image). If inserting the eyepiece directly into the focuser of a refractor (i.e., without the diagonal), the image is upside-down and reversed from left-to-right (i.e., inverted). However, when using the AstroMaster refractor and the standard erect image diagonal, the images is correctly oriented in every aspect.

Newtonian reflectors produce a right-side-up image but the image will appear rotated based on the location of the eyepiece holder in relation to the ground. However, by using the erect image eyepiece supplied with the AstroMaster Newtonians, the image is correctly oriented.

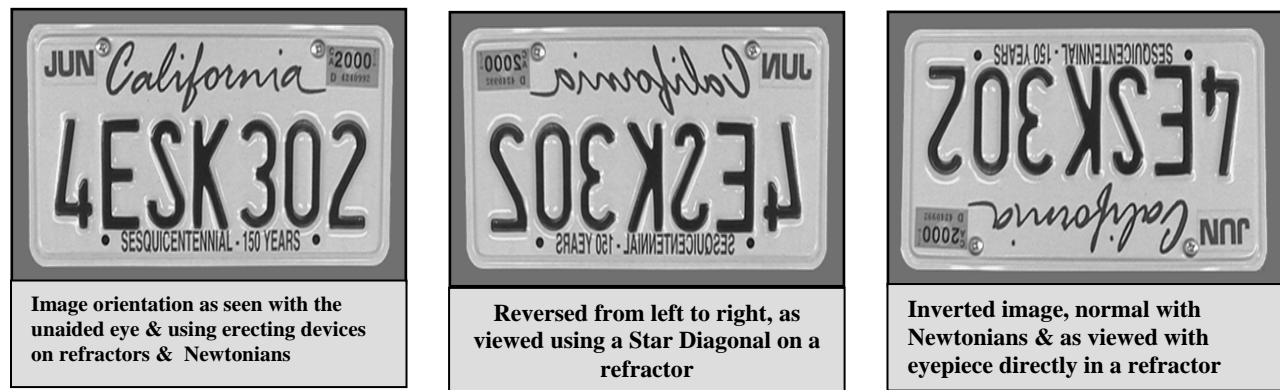

Figure 3-3

Focusing

To focus your refractor or Newtonian telescope, simply turn the focus knob located directly below the eyepiece holder (see Figures 1-1 and 1-2). Turning the knob clockwise allows you to focus on an object that is farther than the one you are currently observing. Turning the knob counterclockwise from you allows you to focus on an object closer than the one you are currently observing.

Note: If you wear corrective lenses (specifically glasses), you may want to remove them when observing with an eyepiece attached to the telescope. However, when using a camera you should always wear corrective lenses to ensure the sharpest possible focus. If you have astigmatism, corrective lenses must be worn at all times.

Aligning the Finderscope

The Star Pointer is the quickest and easiest way to point your telescope exactly at a desired object in the sky. It's like having a laser pointer that you can shine directly onto the night sky. The Star Pointer is a zero magnification pointing tool that uses a coated glass window to superimpose the image of a small red dot onto the night sky. While keeping both eyes open when looking through the Star Pointer, simply move your telescope until the red dot, seen through the Star Pointer, merges with the object as seen with your unaided eye. The red dot is produced by a light-emitting diode (LED); it is not a laser beam and will not damage the glass window or your eye. The star pointer is powered by a long life 3-volt lithium battery (#CR1620) see Figure 3-4. Like all finderscopes, the Star Pointer must be properly aligned with the main telescope before it can be used. The alignment procedure is best done at night since the LED dot will be difficult to see during the day.

Battery Compartment



Figure 3-4

On/Off
Switch



Figure 3-5

To align the Star Pointer finderscope:

1. To turn on the Star Pointer, turn the switch to the “on” position – see Figure 3-4.
2. Locate a bright star or planet and center it in a low power eyepiece in the main telescope.
3. With both eyes open, look through the glass window at the alignment star.
If the Star Pointer is perfectly aligned, you will see the red LED dot overlap the alignment star. If the Star Pointer is not aligned, take notice of where the red dot is relative to the bright star.
4. Without moving the main telescope, turn the Star Pointer's two adjustment screws until the red dot is directly over the alignment star. Experiment as to which way each screw moves the red dot.
5. The Star Pointer is now ready for use. **Always turn the power off after you have found an object. This will extend the life of both the battery and the LED.**

Note: Your battery may be installed already. If not, open the battery compartment – see Figure 3-4 with a thin coin or screwdriver. Put the battery in with the “+” sign facing out. Then put the battery compartment back on. If you ever need to replace the battery, it is a 3-volt lithium type # CR 1620.

Note: The above description applies basically for astronomy. If your finderscope is aligned properly, you can use it for terrestrial applications also. The finderscope acts like a sighting tube. The red dot may be difficult to see in the daytime but the dot will let you align objects before looking through the main telescope optics and can be quite helpful.

Calculating Magnification

You can change the power of your telescope just by changing the eyepiece (ocular). To determine the magnification of your telescope, simply divide the focal length of the telescope by the focal length of the eyepiece used. In equation format, the formula looks like this:

$$\text{Magnification} = \frac{\text{Focal Length of Telescope (mm)}}{\text{Focal Length of Eyepiece (mm)}}$$

Let's say, for example, you are using the 20mm eyepiece that came with your telescope. To determine the magnification you simply divide the focal length of your telescope (the AstroMaster 70AZ for this example has a focal length of 900mm) by the focal length of the eyepiece, 20mm. Dividing 900 by 20 yields a magnification of 45 power.

Although the power is variable, each instrument under average skies has a limit to the highest useful magnification. The general rule is that 60 power can be used for every inch of aperture. For example, the AstroMaster 70AZ is 2.8” inches in diameter. Multiplying 2.8 by 60 gives a maximum useful magnification of 168 power. Although this is the maximum useful magnification, most observing is done in the range of 20 to 35 power for every inch of aperture which is 56 to 98 times for the AstroMaster 70AZ telescope. You can determine the magnification for your telescope the same way.

Determining Field of View

Determining the field of view is important if you want to get an idea of the angular size of the object you are observing. To calculate the actual field of view, divide the apparent field of the eyepiece (supplied by the eyepiece manufacturer) by the magnification. In equation format, the formula looks like this:

$$\text{True Field} = \frac{\text{Apparent Field of Eyepiece}}{\text{Magnification}}$$

As you can see, before determining the field of view, you must calculate the magnification. Using the example in the previous section, we can determine the field of view using the same 20mm eyepiece that is supplied standard with the AstroMaster 70AZ telescope. The 20mm eyepiece has an apparent field of view of 50°. Divide the 50° by the magnification, which is 45 power. This yields an actual field of 1.1°.

To convert degrees to feet at 1,000 yards, which is more useful for terrestrial observing, simply multiply by 52.5. Continuing with our example, multiply the angular field of 1.1° by 52.5. This produces a linear field width of 58 feet at a distance of one thousand yards.

General Observing Hints

When working with any optical instrument, there are a few things to remember to ensure you get the best possible image.

- Never look through window glass. Glass found in household windows is optically imperfect, and as a result, may vary in thickness from one part of a window to the next. This inconsistency can and will affect the ability to focus your telescope. In most cases you will not be able to achieve a truly sharp image, while in some cases, you may actually see a double image.
- Never look across or over objects that are producing heat waves. This includes asphalt parking lots on hot summer days or building rooftops.
- Hazy skies, fog, and mist can also make it difficult to focus when viewing terrestrially. The amount of detail seen under these conditions is greatly reduced.
- If you wear corrective lenses (specifically glasses), you may want to remove them when observing with an eyepiece attached to the telescope. When using a camera, however, you should always wear corrective lenses to ensure the sharpest possible focus. If you have astigmatism, corrective lenses must be worn at all times.

Astronomy Basics

Up to this point, this manual covered the assembly and basic operation of your telescope. However, to understand your telescope more thoroughly, you need to know a little about the night sky. This section deals with observational astronomy in general and includes information on the night sky and polar alignment.

For telescopes with equatorial mounts, the users have setting circles and polar alignment methods to help them find objects in the sky. With your altazimuth mount, you can use a method called “star hopping” which is described in the “Celestial Observing Section” later in this manual. Good star maps are essential in helping you locate deep sky objects and current monthly astronomy magazines will help you locate where the planets are.

The Celestial Coordinate System

To help find objects in the sky, astronomers use a celestial coordinate system that is similar to our geographical coordinate system here on Earth. The celestial coordinate system has poles, lines of longitude and latitude, and an equator. For the most part, these remain fixed against the background stars.

The celestial equator runs 360 degrees around the Earth and separates the northern celestial hemisphere from the southern. Like the Earth's equator, it bears a reading of zero degrees. On Earth this would be latitude. However, in the sky this is referred to as declination, or DEC for short. Lines of declination are named for their angular distance above and below the celestial equator. The lines are broken down into degrees, minutes of arc, and seconds of arc. Declination readings south of the equator carry a minus sign (-) in front of the coordinate and those north of the celestial equator are either blank (i.e., no designation) or preceded by a plus sign (+).

The celestial equivalent of longitude is called Right Ascension, or R.A. for short. Like the Earth's lines of longitude, they run from pole to pole and are evenly spaced 15 degrees apart. Although the longitude lines are separated by an angular distance, they are also a measure of time. Each line of longitude is one hour apart from the next. Since the Earth rotates once every 24 hours, there are 24 lines total. As a result, the R.A. coordinates are marked off in units of time. It begins with an arbitrary point in the constellation of Pisces designated as 0 hours, 0 minutes, 0 seconds. All other points are designated by how far (i.e., how long) they lag behind this coordinate after it passes overhead moving toward the west.

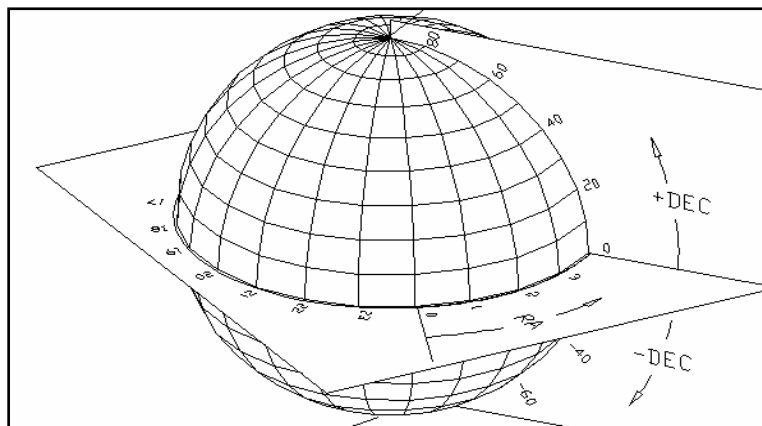
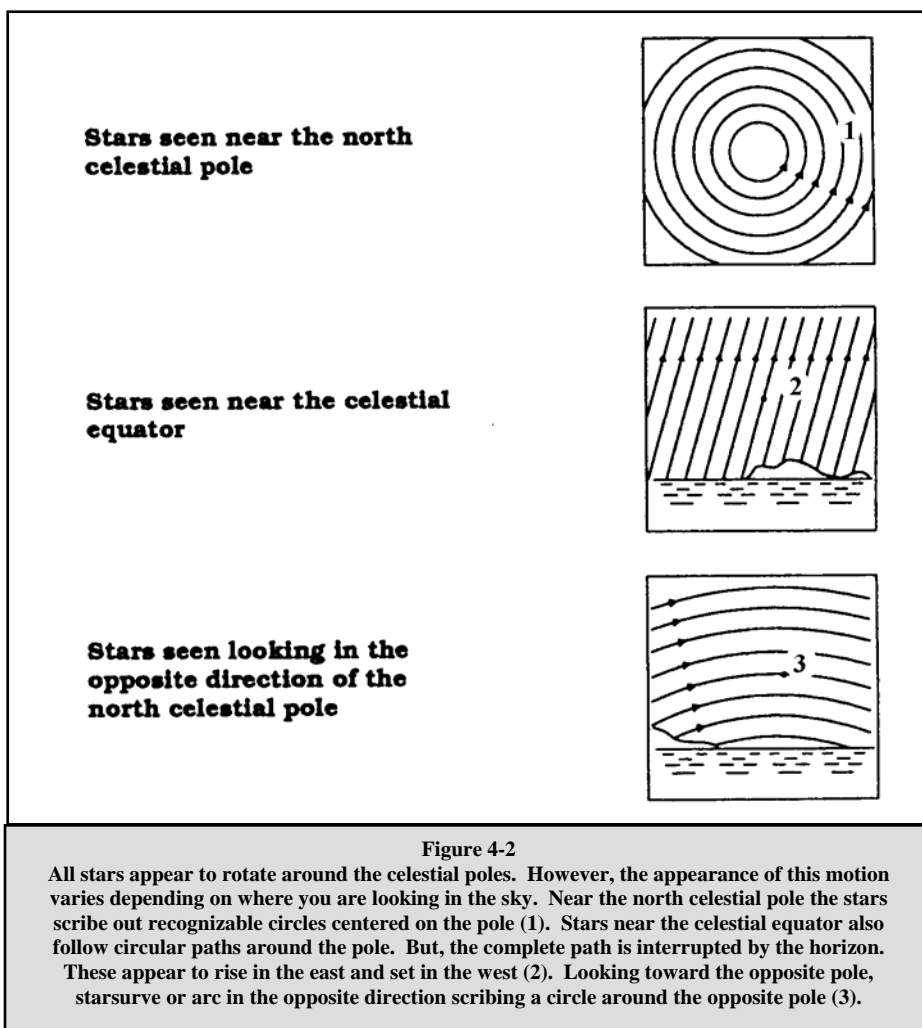

Figure 4-1

The celestial sphere seen from the outside showing R.A. and DEC.

Motion of the Stars

The daily motion of the Sun across the sky is familiar to even the most casual observer. This daily trek is not the Sun moving as early astronomers thought, but the result of the Earth's rotation. The Earth's rotation also causes the stars to do the same, scribing out a large circle as the Earth completes one rotation. The size of the circular path a star follows depends on where it is in the sky. Stars near the celestial equator form the largest circles rising in the east and setting in the west. Moving toward the north celestial pole, the point around which the stars in the northern hemisphere appear to rotate, these circles become smaller. Stars in the mid-celestial latitudes rise in the northeast and set in the northwest. Stars at high celestial latitudes are always above the horizon, and are said to be circumpolar because they never rise and never set. You will never see the stars complete one circle because the sunlight during the day washes out the starlight. However, part of this circular motion of stars in this region of the sky can be seen by setting up a camera on a tripod and opening the shutter for a couple hours. The timed exposure will reveal semicircles that revolve around the pole. (This description of stellar motions also applies to the southern hemisphere except all stars south of the celestial equator move around the south celestial pole.)



Celestial Observing

With your telescope set up, you are ready to use it for observing. This section covers visual observing hints for both solar system and deep sky objects as well as general observing conditions which will affect your ability to observe.

Observing the Moon

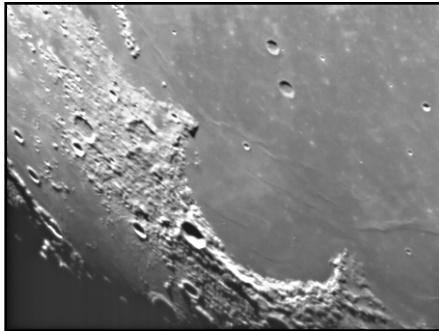

Often, it is tempting to look at the Moon when it is full. At this time, the face we see is fully illuminated and its light can be overpowering. In addition, little or no contrast can be seen during this phase.

One of the best times to observe the Moon is during its partial phases (around the time of first or third quarter). Long shadows reveal a great amount of detail on the lunar surface. At low power you will be able to see most of the lunar disk at one time. Change to optional eyepieces for higher power (magnification) to focus in on a smaller area.

Lunar Observing Hints

To increase contrast and bring out detail on the lunar surface, use optional filters. A yellow filter works well at improving contrast while a neutral density or polarizing filter will reduce overall surface brightness and glare.

Observing the Planets

Other fascinating targets include the five naked eye planets. You can see Venus go through its lunar-like phases. Mars can reveal a host of surface detail and one, if not both, of its polar caps. You will be able to see the cloud belts of Jupiter and the great Red Spot (if it is visible at the time you are observing). In addition, you will also be able to see the moons of Jupiter as they orbit the giant planet. Saturn, with its beautiful rings, is easily visible at moderate power.

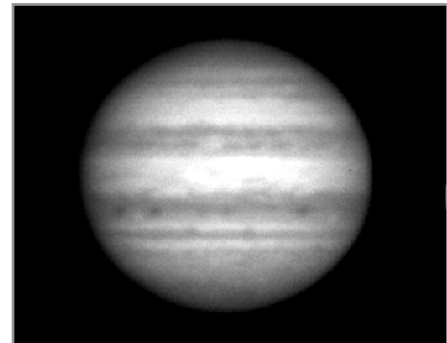

Planetary Observing Hints

- Remember that atmospheric conditions are usually the limiting factor on how much planetary detail will be visible. So, avoid observing the planets when they are low on the horizon or when they are directly over a source of radiating heat, such as a rooftop or chimney. See the "Seeing Conditions" section later in this section.
- To increase contrast and bring out detail on the planetary surface, try using Celestron eyepiece filters.

Observing the Sun

Although overlooked by many amateur astronomers, solar observation is both rewarding and fun. However, because the Sun is so bright, special precautions must be taken when observing our star so as not to damage your eyes or your telescope.

For safe solar viewing, use a solar filter that reduces the intensity of the Sun's light, making it safe to view. With a filter you can see sunspots as they move across the solar disk and faculae, which are bright patches seen near the Sun's edge.

- The best time to observe the Sun is in the early morning or late afternoon when the air is cooler.
- To center the Sun without looking into the eyepiece, watch the shadow of the telescope tube until it forms a circular shadow.

Observing Deep Sky Objects

Deep-sky objects are simply those objects outside the boundaries of our solar system. They include star clusters, planetary nebulae, diffuse nebulae, double stars and other galaxies outside our own Milky Way. Most deep-sky objects have a large angular size. Therefore, low-to-moderate power is all you need to see them. Visually, they are too faint to reveal any of the color seen in long exposure photographs. Instead, they appear black and white. And, because of their low surface brightness, they should be observed from a dark-sky location. Light pollution around large urban areas washes out most nebulae making them difficult, if not impossible, to observe. Light Pollution Reduction filters help reduce the background sky brightness, thus increasing contrast.

Star Hopping

One convenient way to find deep-sky objects is by star hopping. Star hopping is done by using bright stars to "guide" you to an object. For successful star hopping, it is helpful to know the field of view of your telescope. If you're using the standard 20mm eyepiece with the AstroMaster telescope, your field of view is approximately 1°. If you know an object is 3° away from your present location, then you just need to move 3 fields of view. If you're using another eyepiece, then consult the section on determining field of view. Listed below are directions for locating two popular objects.

The Andromeda Galaxy (Figure 5-1), also known as M31, is an easy target. To find M31:

1. Locate the constellation of Pegasus, a large square visible in the fall (in the eastern sky, moving toward the point overhead) and winter months (overhead, moving toward the west).
2. Start at the star in the northeast corner—Alpha (α) Andromedae.
3. Move northeast approximately 7°. There you will find two stars of equal brightness—Delta (δ) and Pi (π) Andromeda—about 3° apart.
4. Continue in the same direction another 8°. There you will find two stars—Beta (β) and Mu (μ) Andromedae—also about 3° apart.
5. Move 3° northwest—the same distance between the two stars—to the Andromeda galaxy.

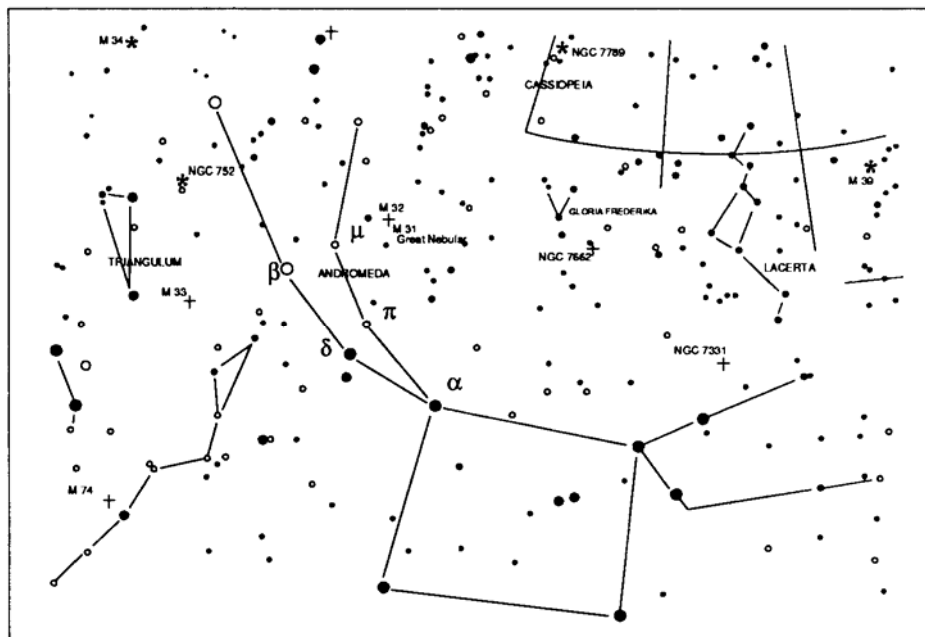

Figure 5-1

Star hopping to the Andromeda Galaxy (M31) is a snap, since all the stars needed to do so are visible to the naked eye.

Star hopping will take some getting used to and objects that don't have stars near them that are visible to the naked eye are challenging. One such object is M57 (Figure 5-2), the famed Ring Nebula. Here's how to find it:

1. Find the constellation of Lyra, a small parallelogram visible in the summer and fall months. Lyra is easy to pick out because it contains the bright star Vega.
2. Start at the star Vega—Alpha (α) Lyrae—and move a few degrees southeast to find the parallelogram. The four stars that make up this geometric shape are all similar in brightness, making them easy to see.
3. Locate the two southernmost stars that make up the parallelogram—Beta (β) and Gamma (γ) Lyra.
4. Point about halfway between these two stars.
5. Move about $\frac{1}{2}^\circ$ toward Beta (β) Lyra, while remaining on a line connecting the two stars.
6. Look through the telescope and the Ring Nebula should be in your field of view. The Ring Nebula's angular size is quite small and difficult to see.
7. Because the Ring Nebula is rather faint, you may need to use "averted vision" to see it. "Averted vision" is a technique of looking slightly away from the object you're observing. So, if you are observing the Ring Nebula, center it in your field of view and then look off toward the side. This causes light from the object viewed to fall on the black and white sensitive rods of your eyes, rather than your eyes color sensitive cones. (Remember that when observing faint objects, it's important to try to observe from a dark location, away from street and city lights. The average eye takes about 20 minutes to fully adapt to the darkness. So always use a red-filtered flashlight to preserve your dark-adapted night vision).

These two examples should give you an idea of how to star hop to deep-sky objects. To use this method on other objects, consult a star atlas, then star hop to the object of your choice using "naked eye" stars.

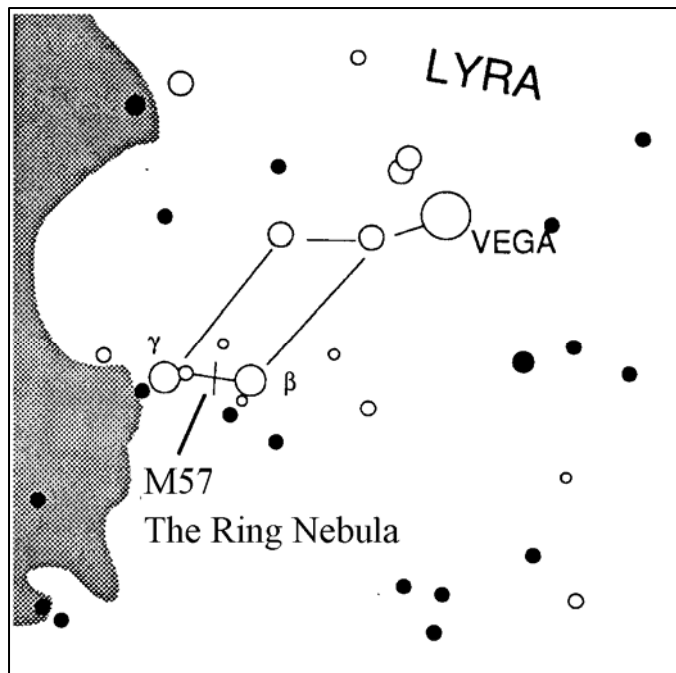

Figure 5-2

Seeing Conditions

Viewing conditions affect what you can see through your telescope during an observing session. Conditions include transparency, sky illumination, and seeing. Understanding viewing conditions and the effect they have on observing will help you get the most out of your telescope.

Transparency

Transparency is the clarity of the atmosphere which is affected by clouds, moisture, and other airborne particles. Thick cumulus clouds are completely opaque while cirrus can be thin, allowing the light from the brightest stars through. Hazy skies absorb more light than clear skies making fainter objects harder to see and reducing contrast on brighter objects. Aerosols ejected into the upper atmosphere from volcanic eruptions also affect transparency. Ideal conditions are when the night sky is inky black.

Sky Illumination

General sky brightening caused by the Moon, aurorae, natural airglow, and light pollution greatly affect transparency. While not a problem for the brighter stars and planets, bright skies reduce the contrast of extended nebulae making them difficult, if not impossible to see. To maximize your observing, limit deep sky viewing to moonless nights far from the light polluted skies found around major urban areas. LPR filters enhance deep sky viewing from light polluted areas by blocking unwanted light while transmitting light from certain deep sky objects. You can, on the other hand, observe planets and stars from light polluted areas or when the Moon is out.

Seeing

Seeing conditions refers to the stability of the atmosphere and directly affects the amount of fine detail seen in extended objects. The air in our atmosphere acts as a lens which bends and distorts incoming light rays. The amount of bending depends on air density. Varying temperature layers have different densities and, therefore, bend light differently. Light rays from the same object arrive slightly displaced creating an imperfect or smeared image. These atmospheric disturbances vary from time-to-time and place-to-place. The size of the air parcels compared to your aperture determines the "seeing" quality. Under good seeing conditions, fine detail is visible on the brighter planets like Jupiter and Mars, and stars are pinpoint images. Under poor seeing conditions, images are blurred and stars appear as blobs.

The conditions described here apply to both visual and photographic observations.



Figure 5-3

Seeing conditions directly affect image quality. These drawings represent a point source (i.e., star) under bad seeing conditions (left) to excellent conditions (right). Most often, seeing conditions produce images that lie somewhere between these two extremes.

Astrophotography

The AstroMaster series of telescopes was designed for visual observing. After looking at the night sky for a while you may want to try your hand at photography of it. There are several forms of photography possible with your telescope for celestial as well as terrestrial pursuits. Below is just a very brief discussion of some of the methods of photography available and suggest you search out various books for detailed information on the subject matter.

As a minimum you will need a digital camera or a 35mm SLR camera. Attach your camera to the telescope with:

- Digital camera – you will need the Universal Digital Camera Adapter (# 93626). The adapter allows the camera to be mounted rigidly for terrestrial as well as prime focus astrophotography.
- 35mm SLR camera – you will need to remove your lens from the camera and attach a T-Ring for your specific camera brand. Then, you will need a T-Adapter (# 93625) to attach on one end to the T-Ring and the other end to the telescope focus tube. Your telescope is now the camera lens.

Short Exposure Prime Focus Photography

Short exposure prime focus photography is the best way to begin imaging celestial objects. It is done by attaching your camera to the telescope as described in the paragraph above. A couple of points to keep in mind:

- Polar align the telescope and start the optional motor drive for tracking.
- You can image the Moon as well as the brighter planets. You will have to experiment with various settings and exposure times. Much information can be obtained from your camera instruction manual which can supplement what you can find in detailed books on the subject matter.
- Do your photography from a dark sky observing site if possible.

Piggyback Photography



Figure 6-1

Only for the 114EQ Newtonian telescope, piggyback photography is done with a camera and its normal lens riding on top of the telescope. Through this method you can capture entire constellations and record large scale nebulae. You attach your camera to the piggyback adapter screw (Figure 6-1) located on the top of the tube mounting ring (your camera will have a threaded hole on the bottom to fit this screw). You will need to polar align the telescope and start the optional motor drive for tracking.

Planetary & Lunar Photography with Special Imagers

During the last few years a new technology has evolved which makes taking superb images of the planets and moon relatively easy and the results are truly amazing. Celestron offers the NexImage (# 93712) which is a special camera and included is software for image processing. You can capture planetary images your first night out which rivals what professionals were doing with large telescopes just a few short years ago.

CCD Imaging for Deep Sky Objects

Special cameras have been developed for taking images of deep sky images. These have evolved over the last several years to become much more economical and amateurs can take fantastic images. Several books have been written on how to get the best images possible. The technology continues to evolve with better and easier to use products on the market.

Terrestrial Photography

Your telescope makes an excellent telephoto lens for terrestrial (land) photography. You can take images of various scenic views, wildlife, nature, and just about anything. You will have to experiment with focusing, speeds, etc. to get the best image desired. You can adapt your camera per the instructions at the top of this page.

Telescope Maintenance

While your telescope requires little maintenance, there are a few things to remember that will ensure your telescope performs at its best.

Care and Cleaning of the Optics

Occasionally, dust and/or moisture may build up on the objective lens or primary mirror depending on which type of telescope you have. Special care should be taken when cleaning any instrument so as not to damage the optics.

If dust has built up on the optics, remove it with a brush (made of camel's hair) or a can of pressurized air. Spray at an angle to the glass surface for approximately two to four seconds. Then, use an optical cleaning solution and white tissue paper to remove any remaining debris. Apply the solution to the tissue and then apply the tissue paper to the optics. Low pressure strokes should go from the center of the lens (or mirror) to the outer portion. **Do NOT rub in circles!**

You can use a commercially made lens cleaner or mix your own. A good cleaning solution is isopropyl alcohol mixed with distilled water. The solution should be 60% isopropyl alcohol and 40% distilled water. Or, liquid dish soap diluted with water (a couple of drops per one quart of water) can be used.

Occasionally, you may experience dew build-up on the optics of your telescope during an observing session. If you want to continue observing, the dew must be removed, either with a hair dryer (on low setting) or by pointing the telescope at the ground until the dew has evaporated.

If moisture condenses on the inside of the optics, remove the accessories from the telescope. Place the telescope in a dust-free environment and point it down. This will remove the moisture from the telescope tube.

To minimize the need to clean your telescope, replace all lens covers once you have finished using it. Since the cells are NOT sealed, the covers should be placed over the openings when not in use. This will prevent contaminants from entering the optical tube.

Internal adjustments and cleaning should be done only by the Celestron repair department. If your telescope is in need of internal cleaning, please call the factory for a return authorization number and price quote.

Collimation of a Newtonian

The optical performance of most Newtonian reflecting telescopes can be optimized by re-collimating (aligning) the telescope's optics, as needed. To collimate the telescope simply means to bring its optical elements into balance. Poor collimation will result in optical aberrations and distortions.

Before collimating your telescope, take time to familiarize yourself with all its components. The primary mirror is the large mirror at the back end of the telescope tube. This mirror is adjusted by loosening and tightening the three screws, placed 120 degrees apart, at the end of the telescope tube. The secondary mirror (the small, elliptical mirror under the focuser, in the front of the tube) also has three adjustment screws (you will need optional tools (described below) to perform collimation. To determine if your telescope needs collimation first point your telescope toward a bright wall or blue sky outside.

Aligning the Secondary Mirror

The following describes the procedure for daytime collimation of your telescope using the optional Newtonian Collimation Tool (#94183) offered by Celestron. To collimate the telescope without the Collimation Tool, read the following section on night time star collimation. For very precise collimation, the optional Collimation Eyepiece 1 1/4" (# 94182) is offered.

If you have an eyepiece in the focuser, remove it. Rack the focuser tube in completely, using the focusing knobs, until its silver tube is no longer visible. You will be looking through the focuser at a reflection of the secondary mirror, projected from the primary mirror. During this step, ignore the silhouetted reflection from the primary mirror. Insert the collimating cap into the focuser and look through it. With the focus pulled in all the way, you should be able to see the entire primary mirror reflected in the secondary mirror. If the primary mirror is not centered in the secondary mirror, adjust the secondary mirror screws by alternately tightening and loosening them until the periphery of the primary mirror is centered in your view. **DO NOT** loosen or tighten the center screw in the secondary mirror support, because it maintains proper mirror position.

Aligning the Primary Mirror

Now adjust the primary mirror screws to re-center the reflection of the small secondary mirror, so it's silhouetted against the view of the primary. As you look into the focuser, silhouettes of the mirrors should look concentric. Repeat steps one and two until you have achieved this.

Remove the collimating cap and look into the focuser, where you should see the reflection of your eye in the secondary mirror.

Newtonian collimation views as seen through the focuser using the collimating cap

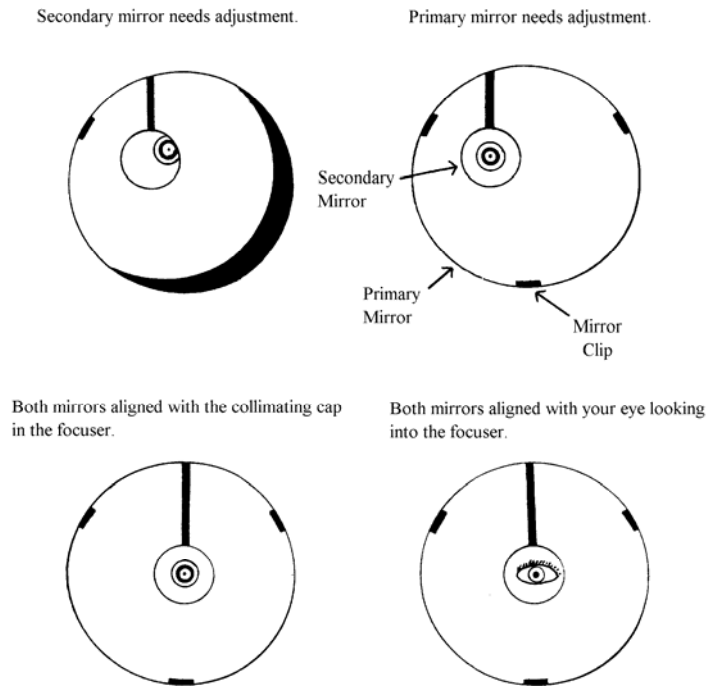

Figure 7-1

Night Time Star Collimating

After successfully completing daytime collimation, night time star collimation can be done by closely adjusting the primary mirror while the telescope tube is on its mount and pointing at a bright star. The telescope should be set up at night and a star's image should be studied at medium to high power (30-60 power per inch of aperture). If a non-symmetrical focus pattern is present, then it may be possible to correct this by re-collimating only the primary mirror.

Procedure (Please read this section completely before beginning):

To star collimate in the Northern Hemisphere, point at a stationary star like the North Star (Polaris). It can be found in the north sky, at a distance above the horizon equal to your latitude. It's also the end star in the handle of the Little Dipper. Polaris is not the brightest star in the sky and may even appear dim, depending upon your sky conditions.

Prior to re-collimating the primary mirror, locate the collimation screws on the rear of the telescope tube. The rear cell (shown in Figure 7-1) has three large thumbscrews which are used for collimation and three small thumbscrews which are used to lock the mirror in place. The collimation screws tilt the primary mirror. You will start by loosening the small locking screws a few turns each. Normally, motions on the order of an $\frac{1}{8}$ turn will make a difference, with approximately a $\frac{1}{2}$ to $\frac{3}{4}$ turn being the maximum required for the large collimation screws. Turn one collimation screw at a time and with a collimation tool or eyepiece see how the collimation is affected (see the following paragraph below). It will take some experimenting but you will eventually get the centering you desire.

It is best to use the optional collimation tool or collimating eyepiece. Look into the focuser and notice if the secondary reflection has moved closer to the center of the primary mirror.

With Polaris or a bright star centered within the field of view, focus with either the standard ocular or your highest power ocular, i.e. the shortest focal length in mm, such as a 6mm or 4mm. Another option is to use a longer focal length ocular with a Barlow lens. When a star is in focus it should look like a sharp pinpoint of light. If, when focusing on the star, it is irregular in shape or appears to have a flare of light at its edge, this means your mirrors aren't in alignment. If you notice the appearance of a flare of light from the star that remains stable in location, just as you go in and out of exact focus, then re-collimation will help sharpen the image.

When satisfied with the collimation, tighten the small locking screws

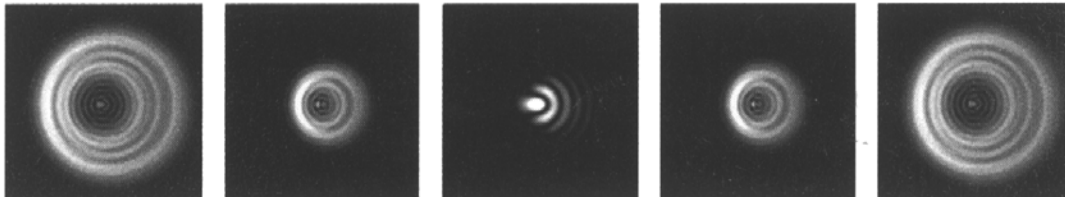

Fig 7-2 Even though the star pattern appears the same on both sides of focus, they are asymmetric. The dark obstruction is skewed off to the left side of the diffraction pattern indicating poor collimation.

Take note of the direction the light appears to flare. For example, if it appears to flare toward the three o'clock position in the field of view, then you must move whichever screw or combination of collimation screws necessary to move the star's image toward the direction of the flaring. In this example, you would want to move the image of the star in your eyepiece, by adjusting the collimation screws, toward the three o'clock position in the field of view. It may only be necessary to adjust a screw enough to move the star's image from the center of the field of view to about halfway, or less, toward the field's edge (when using a high power ocular).

Collimation adjustments are best made while viewing the star's position in the field of view and turning the adjustment screws simultaneously. This way, you can see exactly which way the movement occurs. It may be helpful to have two people working together: one viewing and instructing which screws to turn and by how much, and the other performing the adjustments.

IMPORTANT: After making the first, or each adjustment, it is necessary to re-aim the telescope tube to re-center the star again in the center of the field of view. The star image can then be judged for symmetry by going just inside and outside of exact focus and noting the star's pattern. Improvement should be seen if the proper adjustments are made. Since three screws are present, it may be necessary to move at least two to achieve the necessary mirror movement.

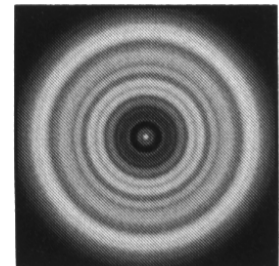
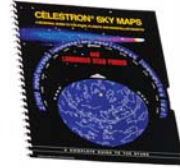

Figure 7-3
A collimated telescope should appear as a symmetrical ring pattern similar to the diffraction disk seen here.

Optional Accessories

You will find that additional accessories for your AstroMaster telescope will enhance your viewing pleasure and expand the usefulness of your telescope. This is just a short listing of various accessories with a brief description. Visit the Celestron website or the Celestron Accessory Catalog for complete descriptions and all accessories available.

Sky Maps (# 93722) – Celestron Sky Maps are the ideal teaching guide for learning the night sky. Even if you already know your way around the major constellations, these maps can help you locate all kinds of fascinating objects.



Omni Plossl Eyepieces – These eyepieces are economically priced and offer razor sharp views across the entire field. They are a 4-element lens design and have the following focal lengths: 4mm, 6mm, 9mm, 12.5mm, 15mm, 20mm, 25mm, 32mm, and 40mm – all in 1.25” barrels.

Omni Barlow Lens (93326)– Used with any eyepiece, it doubles the magnification of that eyepiece. A Barlow lens is a negative lens that increases the focal length of a telescope. The 2x Omni is a 1.25” barrel, is under 3” (76mm) long, and weights only 4oz. (113gr.).

Moon Filter (# 94119-A) – This is an economical 1.25” eyepiece filter for reducing the brightness of the moon and improving contrast, so greater detail can be observed on the lunar surface.



UHC/LPR Filter 1.25” (# 94123) – This filter is designed to enhance your views of deep sky astronomical objects when viewed from urban areas. It selectively reduces the transmission of certain wavelengths of light, specifically those produced by artificial lights.

Flashlight, Night Vision (# 93588) – The Celestron flashlight uses two red LED’s to preserve night vision better than red filters or other devices. Brightness is adjustable. Operates on a single 9-volt included battery.

Collimation Tool (# 94183) – Collimating your Newtonian telescope is easily accomplished with this handy accessory which includes detailed instructions.

Collimation Eyepiece – 1.25” (# 94182) – The collimation eyepiece is ideal for precise collimation of Newtonian telescopes.

Digital Camera Adapter – Universal # 93626) – A universal mounting platform that allows you to do afocal photography (photography through the eyepiece of a telescope) using 1.25” eyepieces with your digital camera.



T-Adapter – Universal 1.25” (# 93625) – This adapter fits the 1.25” focuser of your telescope. It allows you to attach your 35mm SLR camera for terrestrial as well as lunar and planetary photography.

AstroMaster Specifications	21061	21063	31043
	AM 70 AZ	AM 90 AZ	AM 114 AZ
Optical Design	Refractor	Refractor	Newtonian
Aperture	70mm (2.8")	90mm (3.5")	114mm (4.5")
Focal Length	900mm	1000mm	1000mm
Focal Ratio	f/13	f/11	f/9
Secondary Mirror Obstruction -- Dia. - Area	n/a	n/a	31% - 10%
Optical Coatings	Fully coated	Multi-coated	Fully coated
Finderscope	Star Pointer	Star Pointer	Star Pointer
Diagonal 1.25"	Erect Image	Erect Image	n/a
Eyepieces 1.25"	20mm (45x)	20mm (50x)	20mm Erect
Apparent FOV -- 20mm @ 50°			Image (50x)
-- 10mm @ 40°	10mm (90x)	10mm(100x)	10mm (100x)
Angular Field of View w/standard eyepiece	1.1°	1.0°	1.0°
Linear FOV w/standard eyepiece - ft/1000yds	58	53	53
Mount	Altazimuth	Altazimuth	Altazimuth
Pan Handle Control for Altitude	yes	yes	yes
Azimuth Lock	yes	yes	yes
Tripod Leg Diameter 1.25"	yes	yes	yes
CD-ROM "The Sky" Level 1	yes	yes	yes
Highest Useful Magnification	165x	213x	269x
Limiting Stellar Magnitude	11.7	12.3	12.8
Resolution -- Raleigh (arc seconds)	1.98	1.54	1.21
Resolution -- Dawes Limit " "	1.66	1.29	1.02
Light Gathering Power	100x	165x	265x
Optical Tube Length	36" (91cm)	36" (91cm)	20" (51cm)
Telescope Weight	18 # (8.2kg)	20 # (9kg)	17 # (7.7kg)
Note: Specifications are subject to change without notice or obligation			



Celestron
2835 Columbia Street
Torrance, CA 90503 U.S.A.
Tel. (310) 328-9560
Fax. (310) 212-5835
Website www.celestron.com

Copyright 2007 Celestron
All rights reserved.

(Products or instructions may change
without notice or obligation.)

Item # 21061-INST
Printed in China
\$10.00
06-07

Free Manuals Download Website

<http://myh66.com>

<http://usermanuals.us>

<http://www.somanuals.com>

<http://www.4manuals.cc>

<http://www.manual-lib.com>

<http://www.404manual.com>

<http://www.luxmanual.com>

<http://aubethermostatmanual.com>

Golf course search by state

<http://golfingnear.com>

Email search by domain

<http://emailbydomain.com>

Auto manuals search

<http://auto.somanuals.com>

TV manuals search

<http://tv.somanuals.com>