

Overview

The Outdoor Telephone Interface uses a 900 Mhz secure digital radio link that allows secure conversations and gate operator control. The Outdoor Telephone Interface (OTIUEX) is compatible with various Liftmaster Wireless Products.

Carton Inventory

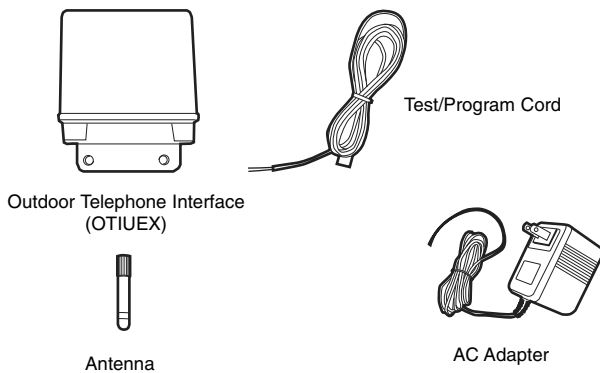

Assembly & Installation

Choose location near the de-mark location.

Step 1

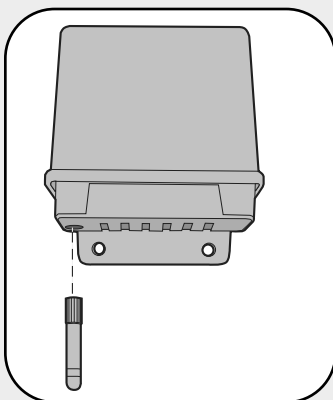

Screw in antenna.

Step 2

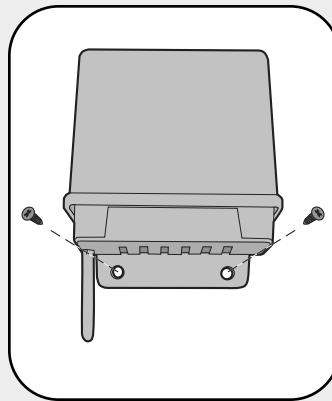

Mount to solid surface.

Wiring to AC Adapter

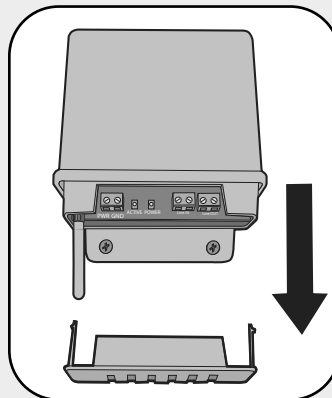

Remove bottom panel of the OTIUEX.

Connect the Solid Black Wire to the GND Terminal (shown below).
Connect the Striped Wire to the +18V Terminal (shown below).

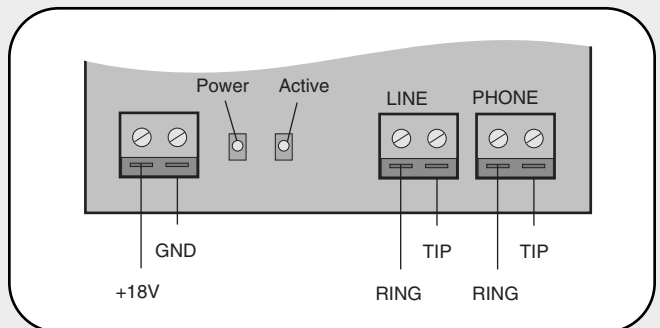

Use the supplied Test/Program Cord for programming and testing before completing connections to phone company's d-mark box.

Program Accessories

NOTE: If programming into an existing network, ensure that the OTIUEX is programmed to the Active unit.

Gate Access Panel (GAPLM)

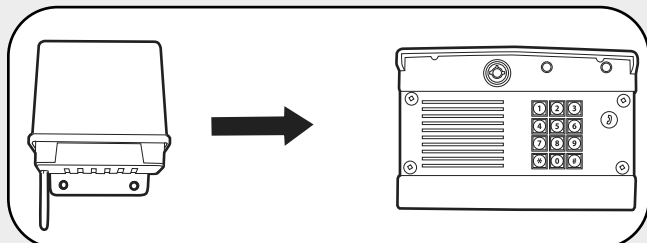

Step 1: On the phone connected to the OTIUEX, press “**07” after hearing the dial tone. Listen for a double beep. Hang up and Learn LED will flash for 15 seconds. If an error tone is heard it means that memory will have to be cleared (see *Troubleshooting*).

Step 2: Within 15 seconds enter Master PIN Number on GAPLM.

Step 3: Press “05” and GAPLM will beep. The OTIUEX will ring the telephone and Caller ID will display “Unit Learned”.

Repeaters

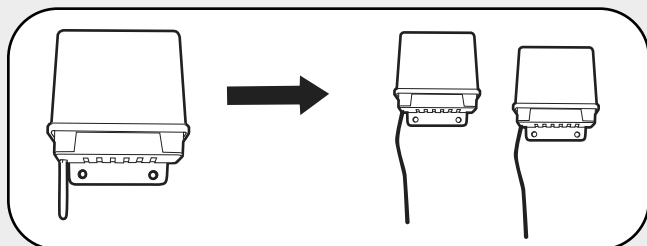

Step 1: On the phone connected to the OTIUEX, press “**07” after hearing the dial tone. Listen for a double beep. Hang up and Learn LED will flash for 15 seconds. If an error tone is heard it means that memory will have to be cleared (see *Troubleshooting*).

Step 2: Within 15 seconds press the Learn button on **ONE** Repeater. LED will light.

Step 3: The OTIUEX will ring the telephone and Caller ID will display “Unit Learned”.

NOTE: If the Repeaters have not been programmed to anything within an existing network, see *Repeater manual for further instructions*.

DAILM

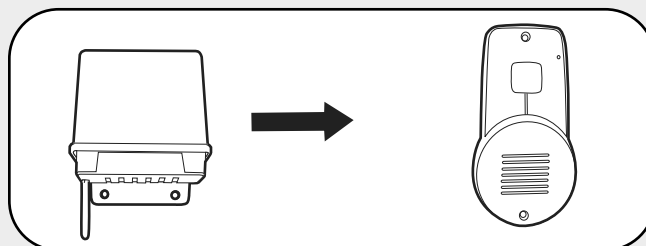

Step 1: Set Dipswitch #1 on the DAILM to the UP position to set the DAILM as a primary device.

Step 2: On the phone connected to the OTIUEX, press “**07” after hearing the dial tone. Listen for a double beep. Hang up and Learn LED will flash for 15 seconds. If an error tone is heard it means that memory will have to be cleared (see *Troubleshooting*).

Step 3: Within 15 seconds, press and release the Learn button on the DAILM.

Step 4: The OTIUEX will ring the telephone and Caller ID will display “Unit Learned”.

Features & Operation

NOTE: Any features of the OTIUEX do NOT require extra service from the Telephone Company.

Answering Calls (Regular Mode)

When visitor presses the Call button on intercom, the telephone connected to the OTIUEX will ring distinctively up to four times. If an expandable OTIUEX system is used all phones within the system will ring. When the phone is answered it will connect to the Intercom at gate or door.

After connecting to the Intercom, the gate can be activated by dialing “*9”.

To activate the primary gate operator dial “*9” on the phone connected to the OTIUEX.

Caller ID

When there is a visitor at the gate the OTIUEX will display “Gate Visitor” on a Caller ID telephone (or Caller ID box) that is directly connected to it.

When there is a visitor at the door, the OTIUEX will display “Front Door” or “Back Door” depending on how you have your door Intercom set up (see Intercom manual).

If someone is tampering with the gate, the OTIUEX will ring the phone and display “!Gate Tamper!”.

Call Waiting

When talking on the phone connected to OTIUEX, a distinctive beep will be heard indicating Call Waiting. Caller ID will alert that there is a visitor. To place call on hold and connect to the Intercom, press the FLASH button.

When talking on phone other than the one connected to the OTIUEX, the telephone connected to the OTIUEX will ring as normal and the call will not be interrupted.

Change Number of Rings

By default the OTIUEX will ring the telephone 4 times. If an answering machine is programmed to pick up after 4 rings, OTIUEX should be changed to ring 3 times. This will prevent the answering machine from picking up if phone is not answered when a visitor calls. If the answering machine does pick up, visitor will hear answering machine message through speaker. Using the telephone connected to OTIUEX, dial :>**102 for 2 rings up through “**105” for 5 rings.

Remote Activation Through Answering Machine

Gate can be remotely activated through the answering machine. Call home and when answering machine picks up, dial “*9”. The OTIUEX will then activate the gate.

Call Forwarding

If user is away from home the OTIUEX can be programmed to call when there is a visitor. When visitor presses Call button the OTIUEX will ring home telephone 1 time. If telephone is not answered, the OTIUEX will dial call-forwarding number that has been programmed. After ringing that number 3 times the OTIUEX will hang up. If visitor presses Call button again the process will repeat.

Answering Calls (Call Forwarding Mode)

When answering call from OTIUEX, a beep will be heard for up to 10 seconds. To accept call, dial “0”.

Hang up to disconnect.

To control the gate dial “*9”.

NOTE: OTIUEX checks if home line is busy prior to dialing forwarding number. If busy, the OTIUEX will wait and try again. Once OTIUEX dials forwarding number, if forwarding number is busy, the OTIUEX will wait and try again.

Programming Call Forwarding Number

On telephone connected to OTIUEX, dial “*#”. A beep will be heard.

Enter the forwarding number (up to 14 digits). To accept new number, press “#”. A beep will be heard.

NOTE: For long distance calls, include proper prefix.

Verifying Call Forwarding Number

On telephone connected to OTIUEX, dial “**06”. A beep will be heard. Hang up the telephone.

The telephone will ring and the call forwarding number that has been programmed will be displayed on Caller ID screen.

Enable/Disable Call Forwarding

To enable call forwarding dial “**01” on telephone connected to OTIUEX. A beep will be heard.

To disable call forwarding dial “**02” on telephone connected to OTIUEX. A beep will be heard.

PIN Number Functions

| Number | Function |
|-------------------|--------------------------------|
| **01 | Enable Call Forwarding |
| **02 | Disable Call Forwarding |
| **07 | Activating the OTIU |
| **06 | Verify Call Forwarding Number |
| **#8 | Clear Memory |
| *9 | Activate Gate |
| **102 - **105 | Change number of rings |
| *#(Phone Number)# | Program call forwarding number |

To enable Canadian Mode press "***13". To disable Canadian Mode press "#*16". The Canadian programming numbers are shown in the table below:

| Number | Function |
|-------------------|--------------------------------|
| #*01 | Enable Call Forwarding |
| #*02 | Disable Call Forwarding |
| #*07 | Activating the OTIU |
| #*06 | Verify Call Forwarding Number |
| #*#8 | Clear Memory |
| #9 | Activate Gate |
| #*102 - #*105 | Change number of rings |
| ##(Phone Number)# | Program call forwarding number |

Troubleshooting

Dial tone is not heard after connecting to the OTIUEX.

Check phone connections. If it is a two-line phone ensure it is on Line 1.

If a dual-tone error tone is heard when trying to open gate, ensure OTIUEX is programmed to the correct GAPLM, DAILM, or Intercom. Check that gate operator has been taught to master unit as well.

If OTIUEX has already been programmed and will need to have memory cleared (see below).

When dialing numbers a dial tone is heard.

All numbers and symbols must be dialed within 3 seconds of each other, otherwise the OTIUEX times out and returns to dial tone.

Memory needs to be cleared.

Clearing OTIUEX memory will not clear any OTIUEX settings or programmed phone numbers. To clear memory, dial "***#8" on the telephone connected to the OTIUEX. A beep will be heard.

To clear DAILM memory, set Dipswitch #1 to the DOWN position, then press the Learn button until a beep is heard (about 15 seconds).

OTIUEX is not getting expected transmission range.

When used in buildings with stucco or cement walls, the range is greatly reduced. The Repeaters can be used close to the building to solve this problem.

Keep OTIUEX away from trees, metal objects, masonry, computers, and any other "Radio Noise Source". Radio devices that run on 900 Mhz also affect range. Turn them off and see if reception has improved.

Keep antenna vertical.

After dialing "9" a beep is heard, then an error tone. Check batteries in GCU.

Will not accept command after dialing "****".

Check the line and telephone connections.

Telephone does not ring when Call button is pressed.

If the Active LED on OTIUEX flashes after Call button is pressed, check telephone connections.

The telephone may not be compatible. Use a 22V adapter instead of the supplied 18V adapter. This changes the REN# from 3 to 5.

If the Active LED on OTIUEX does not flash after the Call button is pressed, see *Programming Accessories* to ensure OTIUEX is programmed correctly.

There is a buzzing or failed connection when call is answered.

Move OTIUEX away from phone and/or computer. Try changing channel of OTIUEX and/or the channel on the GAPLM (see Gate Access Panel manual).

Only first couple of words from caller are heard.

Lower the GAPLM microphone sensitivity (see Gate Access Panel manual).

FOR TECHNICAL SUPPORT DIAL OUR TOLL FREE NUMBER:

1-800-528-2806

www.liftmaster.com

NOTICE: To comply with FCC and or Industry Canada rules (IC), adjustment or modifications of this receiver and/or transmitter are prohibited, except for changing the code setting or replacing the battery. THERE ARE NO OTHER USER SERVICEABLE PARTS.

Tested to Comply with FCC Standards FOR HOME OR OFFICE USE. Operation is subject to the following two conditions: (1) this device may not cause harmful interference, and (2) this device must accept any interference received, including interference that may cause undesired operation.

Free Manuals Download Website

<http://myh66.com>

<http://usermanuals.us>

<http://www.somanuals.com>

<http://www.4manuals.cc>

<http://www.manual-lib.com>

<http://www.404manual.com>

<http://www.luxmanual.com>

<http://aubethermostatmanual.com>

Golf course search by state

<http://golfingnear.com>

Email search by domain

<http://emailbydomain.com>

Auto manuals search

<http://auto.somanuals.com>

TV manuals search

<http://tv.somanuals.com>