



# **DLP™ REAR PROJECTION TELEVISION**

---

## **OPERATION MANUAL**

### **51DLP31A**

Read this manual carefully before operation.



## Features

DLP™ Projection TV adopts DLP™ Digital Light Processing™ technology with DMD micro–display method. With the world’s advanced digital optical display technology, our projection TV is an improved product for better performance. The brightness is more than 450nits, peak contrast is up to 1000:1, picture uniformity is over 80% and the highest resolution is: PC 1024\*768; HDTV 1920\*1080P/1280\*720P, with 16780,000 colors and 24bit true color.

•**Digital HDTV–READY:** Identify and receive 10 kinds of HDTV signal and DVD signal via YPbPr interface automatically: 1920\*1080P @ 60Hz (16:9), 1920\*1080I@50Hz (16:9), 1920\*1080I@60Hz (16:9), 1280\*720P@60Hz (16:9), 720\*480P@60Hz (4:3), 640\*480P@60Hz (VGA), 960\*480P@60Hz (16:9), 720\*480I@60Hz (4:3), 720\*576P@50Hz (4:3), 720\*576I@50Hz (4:3).

•**Computer multi –format adaptive system:** Identify and receive 10 kinds of mainstream computer display signal via PC interface automatically. To realize the XGA, SVGA, VGA input and high definition display: 1024\*768 @ 60/75/85Hz, 800\*600 @ 60/75/85Hz, 640\*480 @ 60/75/85Hz, 720\*400 @ 70Hz.

•**DVI digital video input:** Avoiding conversion from analog to digital, the picture becomes perfect. DVI can receive multi–format digital signal as 480P, 800\*600 @ 60Hz and 576P.

•**3:2 PULL DOWN:** The playing speed of movie film is 24 frame pictures per second. While DVD interval scanning signal is 60 semi–frame pictures per second. 3:2 PULL DOWN movie mode can match these two pictures with a new one between them. The picture quality can be improved to better performance.

## Other features

- 470MHz CATV ready
- Dual–tuner PIP/POP/PBP
- Still picture
- Program compositor
- Digital frequency synthesized tuner
- Super High–contrast fine tint  
black optical screen(0.155mm)
- 236(0~235) programs preset
- Hi–Fi audio system
- No–signal–off
- I<sup>2</sup>C bus control
- Sleep off
- Special digital micro–display surface reflector
- Graphic/semitransparent OSD
- BBE effect treatment
- High–voltage stabilizing circuit
- Puzzle
- HDTV/DVD video component in terminals
- AVC
- MDB

# CONTENTS

PRECAUTIONS .....	1
■ INTRODUCTION	
◆ Control Buttons .....	2
■ INSTALLATION	
◆ To install the Projection TV .....	4
◆ To connect the Antenna .....	5
◆ Replacing the lamp .....	6
◆ To install Remote Batteries .....	7
■ BASIC BUTTONS	
◆ Power .....	8
◆ Numeric buttons .....	8
◆ P-/+, V-/+ .....	8
◆ DISPLAY .....	9
◆ RECALL .....	9
◆ MUTE .....	9
■ TUNING IN	
◆ Power on/off .....	10
◆ Auto Search .....	11
◆ Search .....	12
◆ Frequency Fine Tuning .....	13
◆ Skip .....	13
◆ Other Functions of Search Menu .....	14
■ PICTURE SELECTION	
◆ Picture Mode Selection .....	15
◆ Picture Adjustment .....	15
■ SOUND SELECTION	
◆ Sound Mode Selection .....	16
◆ Sound Adjustment .....	16
■ OTHER OPERATIONS	
◆ STILL, PC, DVI, HD ,SPLIT, EXIT Buttons .....	17
◆ SET Menu .....	18
◆ Channel Sort .....	18
◆ Channel Browsing .....	19
■ PIP OPERATIONS .....	20
■ EXTERNAL EQUIPMENT CONNECTION	
◆ A/V OUTPUT .....	22
◆ A/V INPUT .....	23
◆ Digital HD monitor–receiver .....	25
◆ PC INPUT .....	26
◆ DVI INPUT .....	28
◆ Operation and adjustment .....	29
■ TROUBLESHOOTING .....	30
■ SPECIFICATIONS AND ACCESSORIES .....	30

※ The OSD and figures shown in this manual may be somewhat different from the actual situation.

---

# PRECAUTIONS

## Warning

- ※ High voltage inside ! non-professionals can not open the back cover. If a problem occurs (such as no picture or no sound, or if smoke or an abnormal odor starts to come out from the projection TV), immediately unplug the power cord and contact the service agency as soon as possible
- ※ Allow enough space (at least 10cm) between the projection TV and the other subject for proper ventilation, and do not jam the cooling fans.
- ※ Turn the power off before replacing the lamp.

## Notice

- ※ Do not expose the projection TV to direct sunlight or place it near heat sources, moisture and dust, or where the rain can reach.
- ※ To prevent the projection TV from falling off or tipping over, place the unit on stable and flat surface without vibration. Prevent child from peeling on the unit.
- ※ Set up a lighting arrester when an out door antenna is used. Do not turn on the projection TV during a lighting storm. At lighting intervals, pull out the power cord and antenna cable.
- ※ Please turn off power supply of the projection TV while outgoing, in case the projection TV is not to be used for long period of time, please pull out the power cord and antenna cable.
- ※ Do not place any objects on top of the projection TV, these may cause deformation to the cabinet and screen.
- ※ Avoid hard objects hitting on the projection TV (especially the screen) or excessive shock when moving the projection TV.

## Cleaning and Maintenance

- ※ Please clean the cabinet regularly with a dry soft cloth. Stubborn stains may be removed with a cloth slightly damped with solution of mild soap and warm water. Never use strong solvents for cleaning.

# INTRODUCTION

## Control Buttons

Front panel

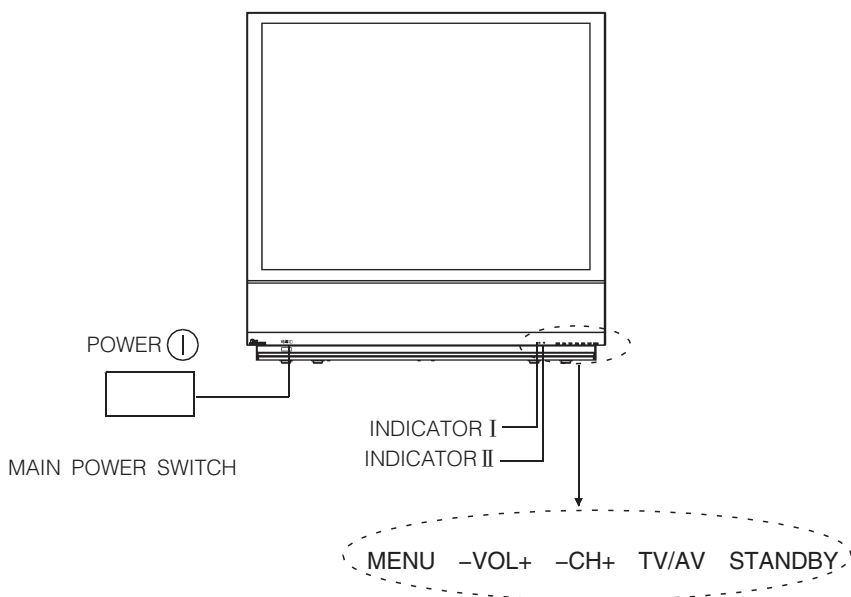

Rear panel

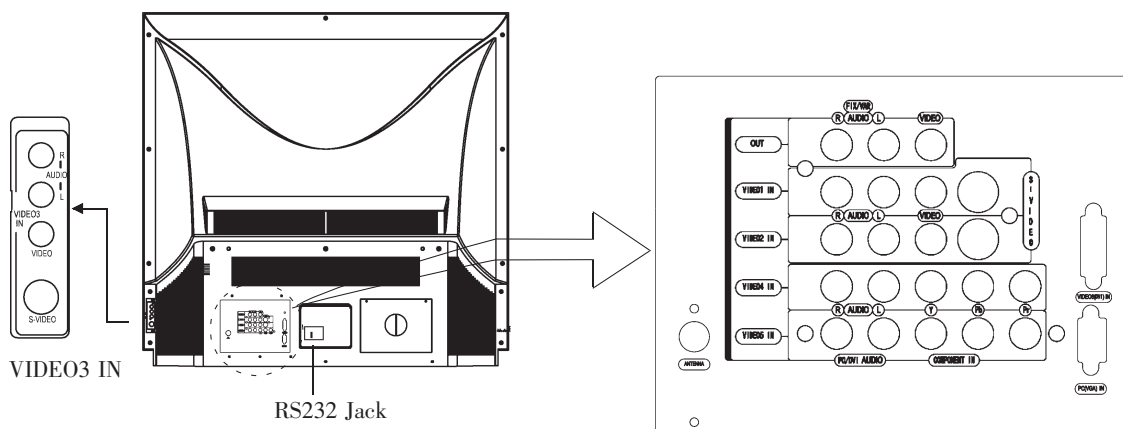

Notes:

- ① The buttons of the same name on the remote control or the projection TV's front panel share the same function. The following section of this manual will focus on operation method of the remote control.
- ② The figures shown in this manual may be somewhat different from the actual situation, please reference to the practicality.

# INTRODUCTION (continued)

## Control Buttons (continued)

remote control

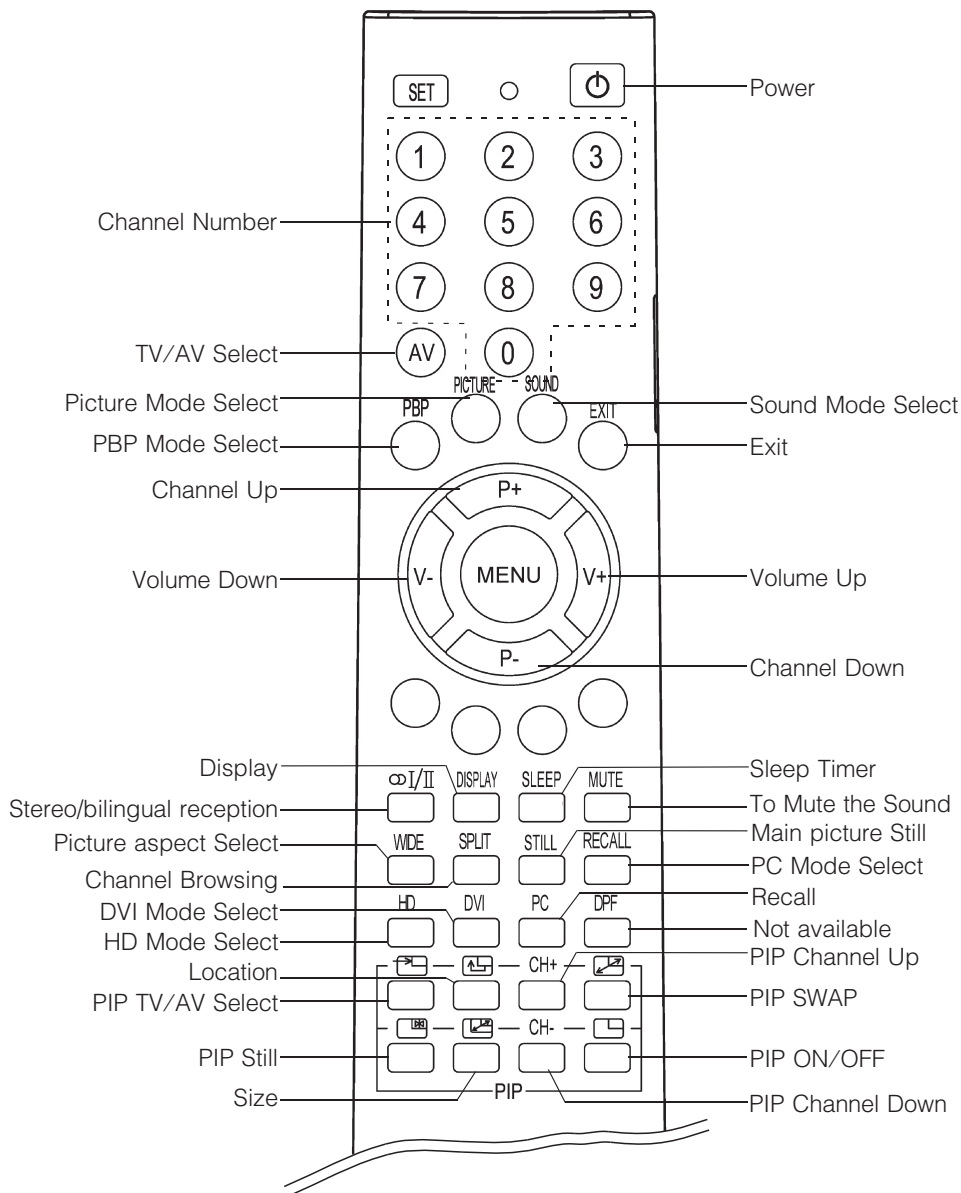

Note:

The button design and specifications of the remote control are subject to change without notice.

---

# INSTALLATION

## To Install the projection TV

- Please read the PRECAUTIONS completely before installation.
- It is recommended to watch projection TV in soft and indirect light and face center of the screen for optimum viewing effect.
- Allow enough space (at least 10cm) between the projection TV and the other subject for proper
- Avoid excessively warm or wet locations to prevent possible damage to the cabinet or components.

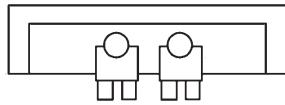

Keep proper watching distance.

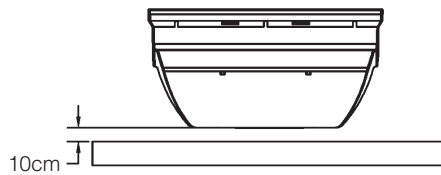

After installation, plug the projection TV in the supply socket.



---

# INSTALLATION

## To Connect the Antenna

An outdoor antenna or CATV is recommended for the best reception. The antenna type and its location differ dependent on local conditions.

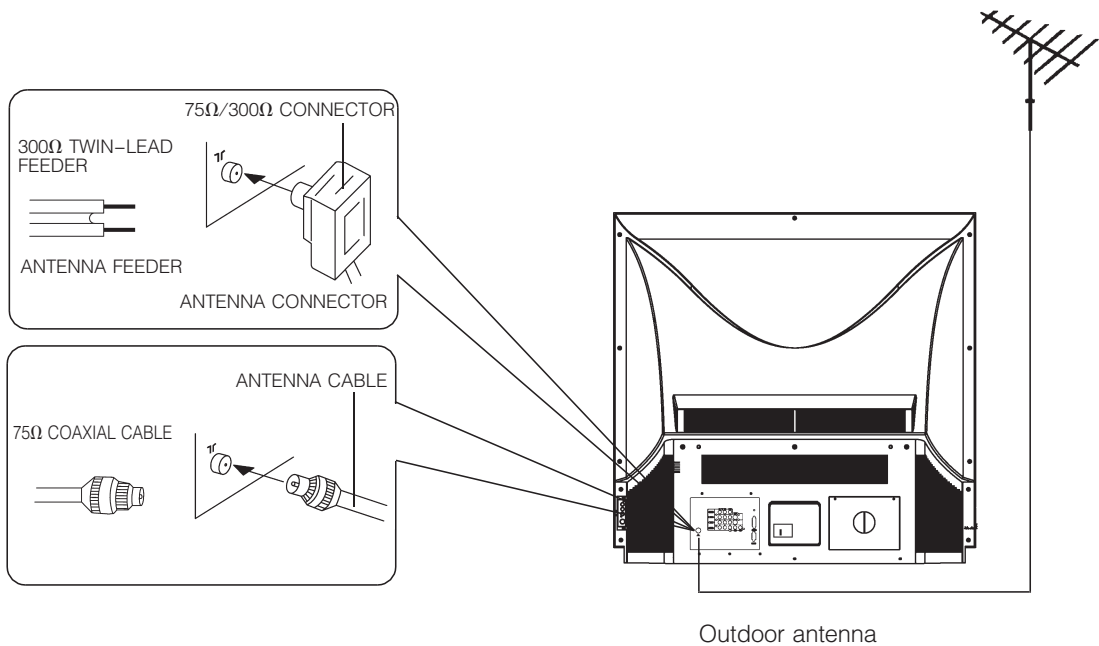

### Notes:

- ① It is recommended that a 75Ω coaxial cable be used in order to eliminate possible interference and noise which may occur due to nearby radio transmissions.
- ② When using a 300Ω twin-lead feeder, connect it to a 300Ω/75Ω converter and insert the converter into the projection TV's ANTENNA IN terminal.
- ③ Connect an outdoor antenna referring to the above figure. Set up a lightning arrester and check it regularly when an outdoor antenna is used.
- ④ The antenna cable should not be tied together with other wiring.

# INSTALLATION

## Replacing the Lamp

The lamp used in a projection TV has a limited lifespan. It should be replaced when the screen becomes darker, less clear, has no effect after image adjusted or the lamp doesn't work. Please replace the lamp with operation manual's guide. (Note: You'd better refer the servicing to qualified service personnel of Dealer.) After replacing the lamp, as the screen quality will be bright and clear as new.

To replace the lamp, please follow these steps:

- ① Unplug TV, then use a screwdriver to remove the lamp cover.

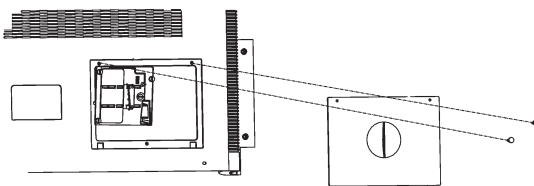

- ② Use a screwdriver to unfasten 3 screws securing the lamp and separate the lamp from the engine. (Unfasten the screws is ok)

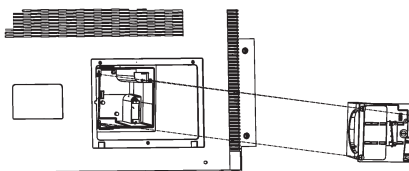

- ③ Put in the new lamp and lock the screws securing the lamp.

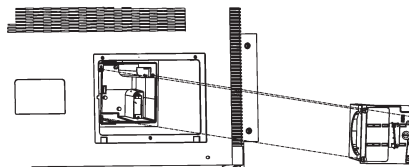

- ④ Fix the lamp cover.

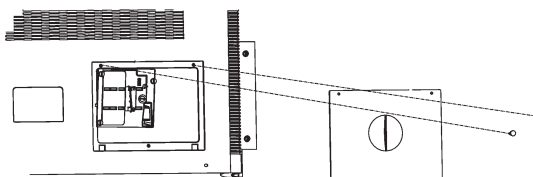

- ※ The lamp must be the same code number and type avoiding damage of TV.
- ※ Turn the power off and wait for 30 minutes before replacement.
- ※ Do not touch the glass part of the lamp to avoid injuring by sudden break; do not place the old lamp within the reach of children.
- ※ Please note that when indicator II turns red, it means the lamp doesn't work well. Specify by a table on page 10.

---

## INSTALLATION (continued)

### To Install Remote Batteries

Remove the back cover to reveal the battery compartment and make sure you insert the batteries the right way round.

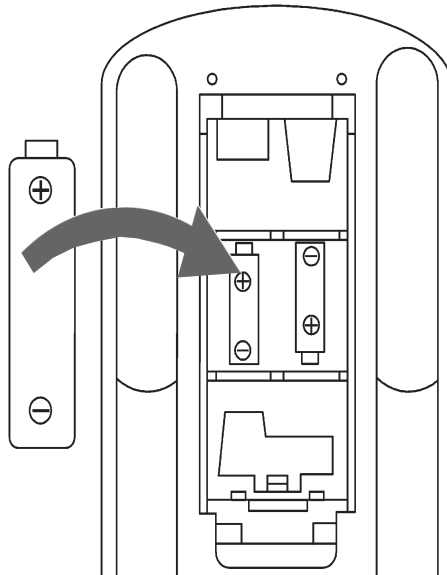

- ※ Suitable battery types for this remote are R03 or AAA.
- ※ Do not combine a used, old battery with a new one or mix battery types.
- ※ To avoid battery leakage, remove batteries from the remote control when it is not to be used for a long period of time or the batteries are exhausted.
- ※ Do not throw your old batteries into a fire, dispose of them in a designated disposal area. Do not expose batteries to fire or disassemble them.

#### •Caring for the remote control

- ※When in operation, please point the remote control directly to the center of the projection TV screen.
- ※Do not repeatedly press the buttons on the remote control too quickly.
- ※Do not expose the remote control to impacts, water or disassemble it.
- ※The performance of the remote control will deteriorate beyond a distance of five metres or outside an angle of 30 degrees from the centre of the TV.

---

# BASIC BUTTONS

## Power



To enter or exit standby mode, press POWER on the remote control. Standby function enables you to reduce power consumption and damaging to the lamp.

※ Don't leave your projection TV in standby mode for a long time, turn the power off when left unattended for a long period of time.

## Numeric buttons



Press the Numeric buttons to enter position number respectively.

※ TV will switch to the channel number you chose without pressing on other numeric buttons in 3 seconds.  
※ The set has 0~235 programs preset.

## P-/+ , V-/+

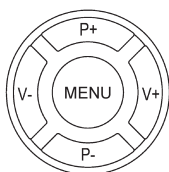

Press P-/+ to select a lower or upper position number.

Press V-/+ to decrease or increase volume.

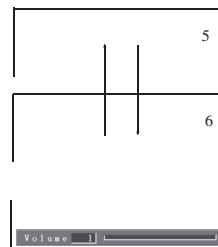

## BASIC BUTTONS (continued)

### DISPLAY



Press DISPLAY to display the current position number and time settings.



※Time display is available only after you adjust the Timer.

### RECALL



Press RECALL repeatedly to switch the projection TV between the current program position and previous program position.

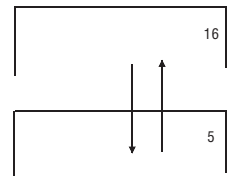

### MUTE



Use the MUTE function to disable the sound.  
Press it again to exit.











※Pressing V+ can also cancel the MUTE function.

※Pressing V- can decrease the volume in the MUTE mode, but can not cancel the MUTE mode.

# TUNING IN

## Power on/off

- 1  Press  on the projection TV. The power indicator will light up and the projection TV enters the STANDBY mode.
- 2  In the STANDBY mode, press the , P-/+ on the remote control or POWER on the panel to turn on the projection TV.
- 3  Press  again on the remote control or on the front panel and the projection TV enters STANDBY mode.
- 4  To turn off the projection TV completely, press .

- ※ The TV is a top grade exact appliance. Do not ON/OFF the power in high frequency to avoid damage the lifespan of lamp.
- ※ Do not unplug TV before yellow indicator is off when presses power off.
- ※ Different status of indicator tells you how's TV going.

Indicator I	Indicator II	TV working status
OFF	OFF	Unplug TV
Blue	OFF	Standby state
OFF	Yellow Flicker	Operating
OFF	Green	Normal working status
Blue Flicker	Green	Receiving the operation order
OFF	Red	Lamp doesn't work well (temperature is too high). Turn off the TV for a while or replace the lamp.
OFF	Red Flicker	Ventilation hole is blocked, Turn off the TV
Blue	Red & Green	The lamp cover doesn't fix well.
Blue Flicker	Green Flicker	Updating

- ※ Screen will display "please check flow system" when the fan doesn't work well or the inner temperature is too high. The red indicator will blinking and TV will automatically be turned off. Please check Ventilation fan and environmental temperature of TV after unplug the set.

### •Auto off without signal reception

When a channel has no signal (e.g. the TV station fails to send signals) and blue background appears, the projection TV will automatically turn off when no button is pressed within 15 min.  
(The function only works in the TV mode.)

### •Sleep auto off

Press  to set auto off after a certain time.

# TUNING IN (continued)

## Auto Search

1



Press MENU repeatedly to call up the CHANNEL menu.

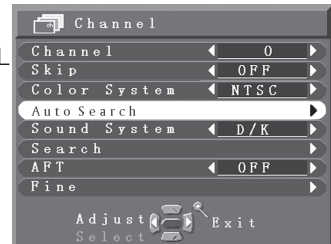

2

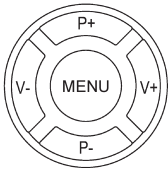

Press P-/+ to highlight "Auto Search".

3

Press V-/+ and auto search memory begins. All received programs can be searched.

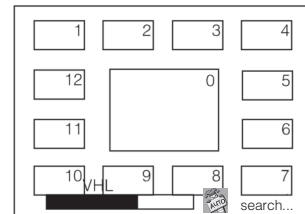

4

It returns to POS 1 after auto search.

- ※ Pressing V-/+ or MENU stops auto-searching and stop in the previous searched program status, and return to SEARCH mode.
- ※ Auto searching begins from POS 1. Users are recommended to use POS "0" for external equipment connections like tape recorder.
- ※ The color system is set to AUTO, sound system to D/K for the searched program. Adjust color, and sound systems if the picture is not in its best position.

## TUNING IN (continued)

### Search

- 1  Press the P-/+ or Numeric buttons to select a program position to be tuned. For example, POS 2.

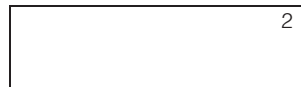

- 2  Press MENU to call up CHANNEL menu.

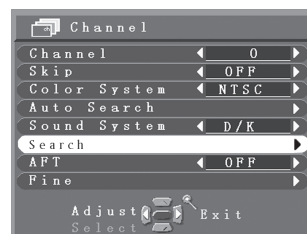

- 3 Press P-/+ to highlight "Search".

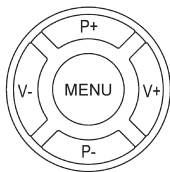

- 4 Press V-/+ to search lower or upper program position until the projection TV searches the desired program.

※The projection TV stops searching when a program search has completed and will then return to the main menu. Continue searching if the searched program is not your desire.  
※Pressing MENU stops searching and returns to the previous status.



# TUNING IN (continued)

## Frequency Fine Tuning

When the picture and sound of a channel are not satisfactory, please use the FREQUENCY FINE TUNING function.

- 1  Select a program position for fine tuning. For example, POS 2.



- 2  Press MENU to call up CHANNEL Menu.

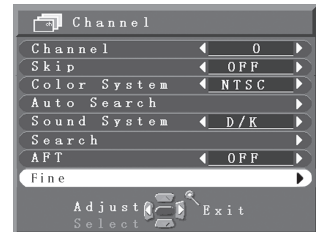

- 3  Press P-/+ to highlight "Fine".

- 4 Press V-/+ repeatedly until you get the best sound and picture effect.

## Skip

Enables you to skip the program you don't want to watch.

- 1  Press Numeric buttons or P-/+ to select the channel you want to adjust.

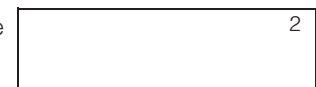

- 2  Press MENU repeatedly to call up CHANNEL menu.



- 3  Press P-/+ to highlight "Skip".

- 4 Select "ON" or "OFF" by pressing V-/+.

※ The position number is black in normal operation becomes red after "SKIP ON" is set. The position number is red after fine-tuning and jump setting.

# TUNING IN (continued)

## Other Functions of Search Menu

Color system, sound system and AFT in CHANNEL menu are available for setting.

1  Press Numeric buttons or P-/+ to select the CHANNEL you want to adjust.



2  Press MENU repeatedly to call up menu.

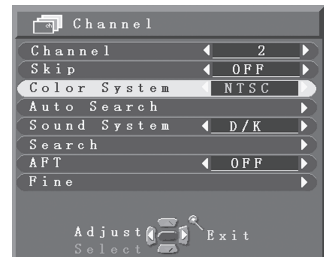

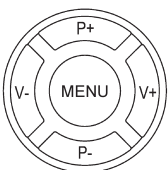
3  Press P-/+ to highlight the item you want to adjust.

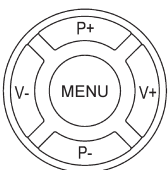
4  Press V-/+ to adjust.

※Channel: Enables you to change position number with menu displays.

※ You may select one of the five color systems.



The color system is generally set to AUTO so that signal system can be automatically identified (not for PAL60 and SECAM).

※You may select one of the four sound systems.

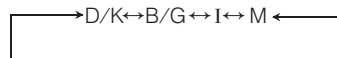

※AFT: Enables you to auto-trace the frequency of signals.

# PICTURE SELECTION

## Picture Mode Selection



The following four modes are available by pressing PICTURE repeatedly.

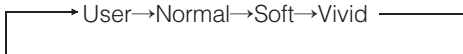

※ Improve picture quality for your projection TV by using VIDEO menu when you aren't satisfied with the above-mentioned modes. See "Picture Adjustment" for details.  
 ※ Press PICTURE to zoom in or zoom out in PC input mode.

## Picture Adjustment



Press MENU repeatedly to call up VIDEO menu.

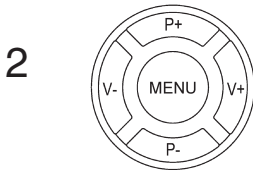

Press P-/+ to select the item you want to adjust.

Press V-/+ to adjust.



Item	Adjustment Effect	
	-	+
Mode	5 Choices	
Brightness	Darker	Brighter
Contrast	Lower	Higher
Sharpness	Lighter	Deeper
Color	Lower	Higher
Tint	More Purple	More Green

※ TINT adjustment is only available for NTSC signal.  
 ※ The adjustable TINT range is -50~+50 while other adjustments are 0~100.  
 ※ TFNR (Dynamic noise decrease) can improve picture quality. You can choose from "strong", "weak" and "off"  
 ※ Advance can enter into sub-menu to adjust the V.center or H.center.  
 ※ Color temperature can choose from "Cold", "Warm" and "Normal".  
 ※ Recommend value of TV/AV signal is 20~40, HD, PC, DVI Signal is 50~100.

# SOUND SELECTION

## Sound Mode Selection



Press SOUND to select one of the four sound modes.

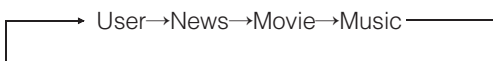

※ Improve sound quality for your projection TV by using the SOUND menu if you aren't satisfied with the above-mentioned modes.

## Sound Adjustment

1



Press MENU to call up the AUDIO menu.

2

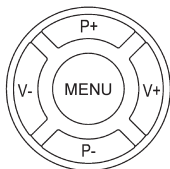

Press P-/+ to select an adjustment. Then press V-/+ to adjust.



※ The range of items:  
BASS and TREBLE: 0-100  
BALANCE: -50- +50

---

## OTHER OPERATION

### STILL button

Press still to make the current picture stillness. There is a prompt on the lower screen. Press it again to exit.

### PC button

Press PC to enter PC mode and display PC input signal. Press it again to return to TV mode.

### DVI button

Press DVI to enter DVI mode and display digital input signal. Press it again to return to TV mode.

### HD button

Press HD to enter YPbPr(HD) mode and display high definition input signal. Press it again to return to TV mode.

### PBP button

Press PBP to enter the PBP mode. Press it again to exit.

※ The picture on the right side is the sub-picture in PBP mode.
---

### EXIT button

Press EXIT to exit operation from the menu and the sound, etc.

### ∞I/II button

Press to receive stereo or bilingual signal.

## OTHER OPERATIONS (continued)

### SET Menu

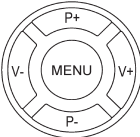
-  Press MENU repeatedly to select the SETUP menu.
-  Press P-/+ to highlight an adjustment, then press V-/+ to adjust.





- ※ With Blue Screen on, the projection TV will display a blue background and mute automatically when no signal received. With Blue Screen off, the projection TV will display noise dots on the screen in the TV mode or the screen becomes dark in the AV mode when no signal is present.
- ※ Only with Blue Screen on, can the screen saver activate. With Screen Protect on, the projection TV will display screen protect letters when no signal is present.
- ※ Movie mode only adjustable in NTSC system and 480I input.

### Channel Sort

In SETUP menu, you can choose the favorite programs using Channel Sort.

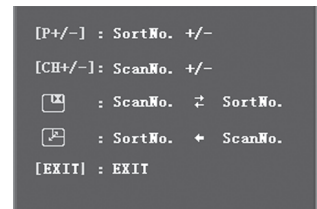
Highlight "Channel Sort" in the SETUP menu. Press V+/- to operate.



- ※ Press  to swap the program between the browsing window and compositor window.
- ※ Press  to set the program in the browsing window after the program in compositor window.

### X-power Demo

- In SETUP menu, you can choose the "X-power Demo".
- Press V-/+ to enter the X-power Demo.

- ※ Press any key can be end the Demo.

## OTHER OPERATIONS (continued)

### Channel Browsing

1



Press to display the right figure on the screen.  
Press it again to return to full screen.

2

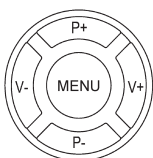

These small pictures are updated in a certain interval.

3

Press P+/- or numeric buttons to choose the content of the main picture.

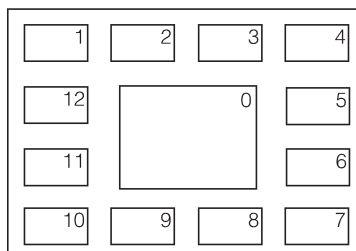

Press ( ) to stop browsing. Press CH+/- to change the program in the browsing window or press to swap program with the main picture; Press ( ) to restart browsing.

# PIP OPERATIONS

## PIP on/off

1



Press repeatedly to scan through the following modes:

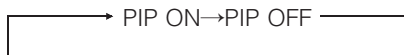

2



When PIP is on, press MENU to turn on PIP menu.

3

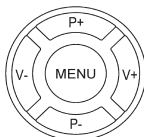

Press P-/+ to select an item you want to adjust and press V-/+ to adjust.



## PIP SWAP



Press to switch between the main and sub-pictures.

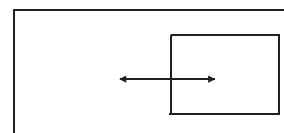

## PIP CH-/+

CH+



CH-



Press to select an upper or lower number for PIP.

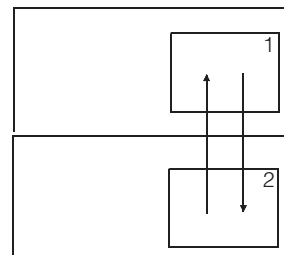

## PIP LOCATION



Press to change the position of a sub-picture.

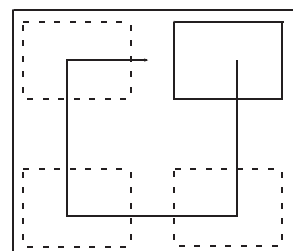



---

## PIP OPERATIONS (continued)

### PIP SIZE



Press to scan through the following modes:  
BIG SIZE→SMALL SIZE

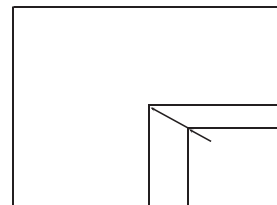
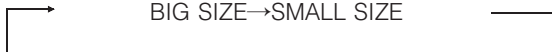

### PIP AV/TV



Press to switch between PIP AV and PIP TV for  
sub-picture.

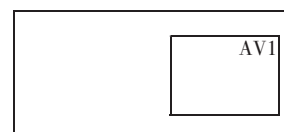

※ Signals from DVD COMPONENT IN and SVGA IN aren't available to be displayed on the sub-picture.

### PIP STILL



Press to make PIP picture still.

# EXTERNAL EQUIPMENT CONNECTION

## A/V OUTPUT

You can connect A/V IN jacks of stereo system, VCR, and other A/V receiver to MONITOR OUT on the rear panel of your projection TV.

### Procedure:

Disconnect all power sources before making any connections, and read the instructions carefully in the manual.

#### ·Connecting stereo system

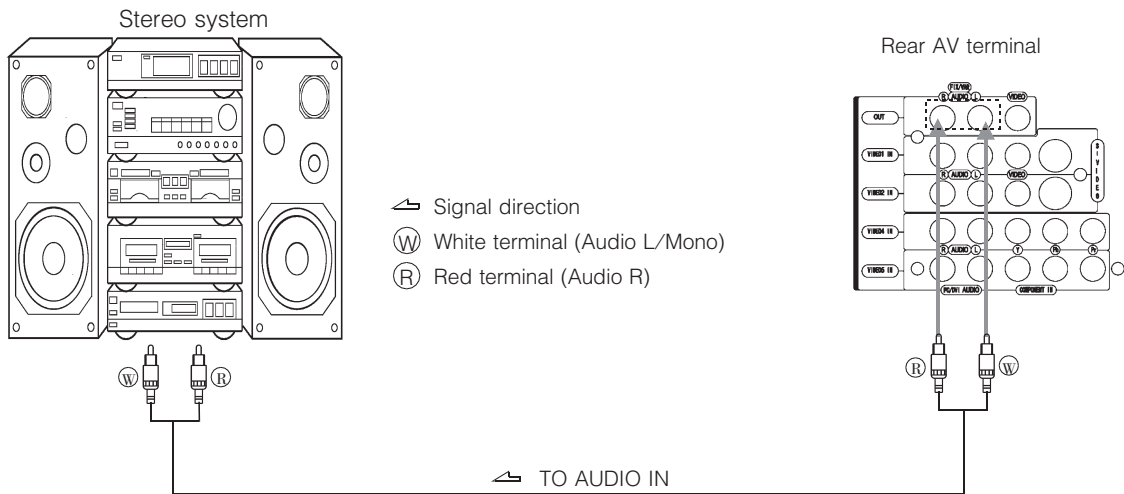

#### ·Connecting VCR

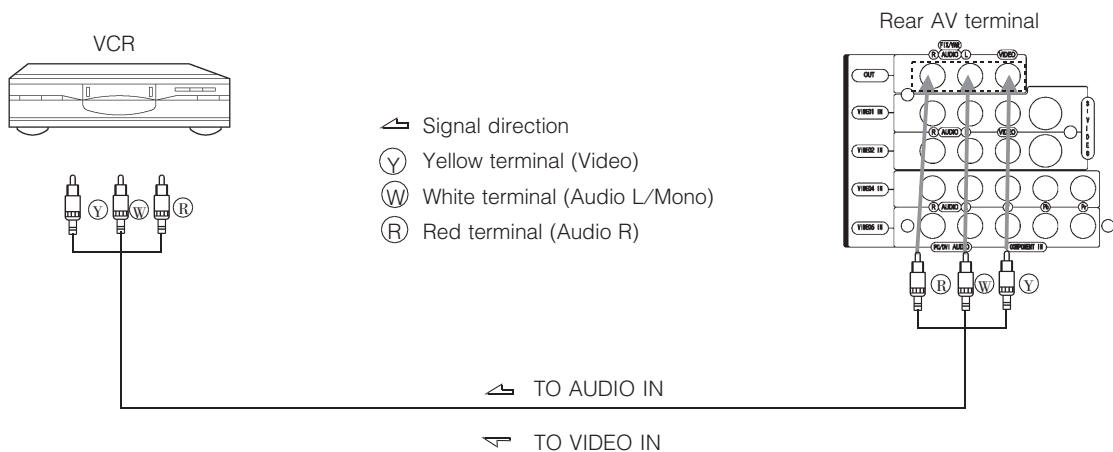

# EXTERNAL EQUIPMENT CONNECTION

## A/V INPUT

You can connect AV OUT of stereo system, VCR and DVD player to AV IN on the side and rear panels of your projection TV.

### Procedure:

Disconnect all power sources before making any connections, and read the instructions carefully in the manual.

※ If use Video Input and S terminal of the same AV at the same time. S terminal is in priority.

• If your VCR does not have S-VIDEO terminal.

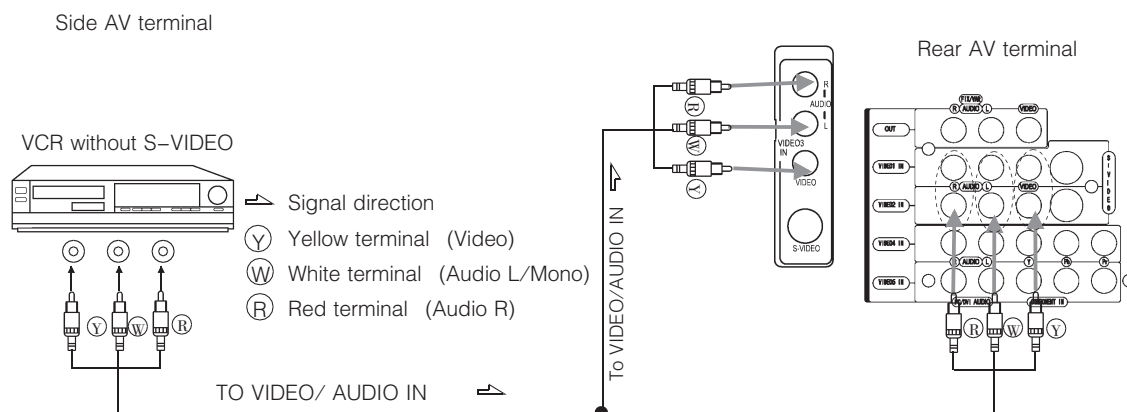

• If your VCR have S-VIDEO terminal.

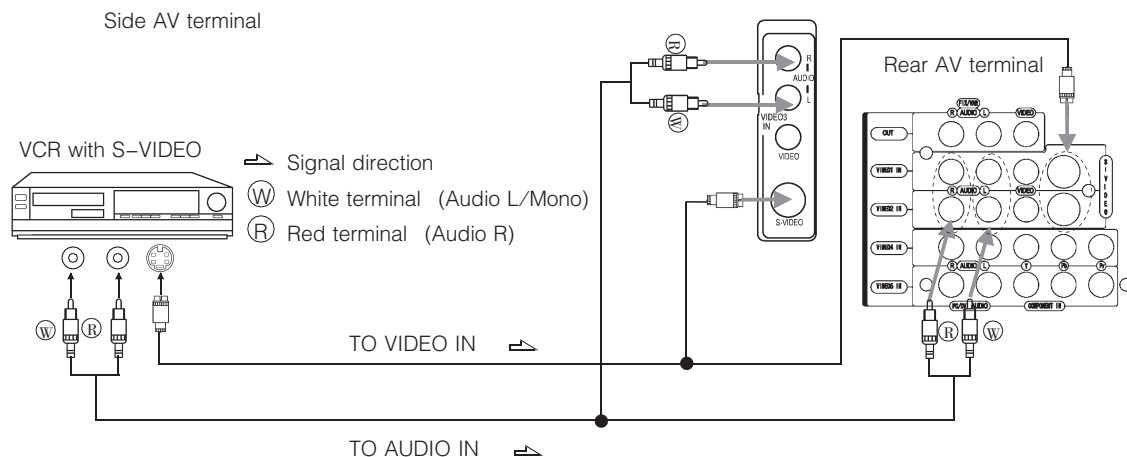

※ The projection TV only receives the signal from VCR when connecting RF OUT of VCR to the antenna terminal of projection TV.

# EXTERNAL EQUIPMENT CONNECTION

## A/V INPUT (continued)

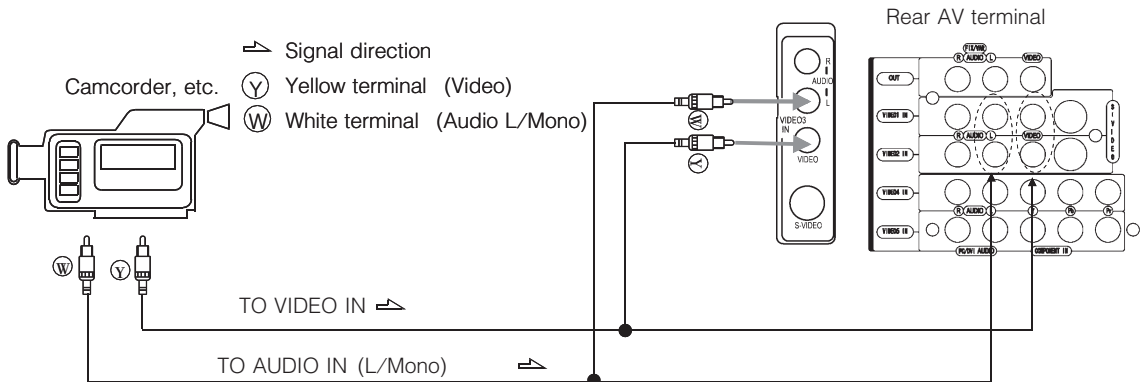

※Connect AUDIO OUT (IN) of external equipment to LEFT/MONO IN (OUT) of your projection TV if that equipment doesn't have STEREO OUT (IN).

### Connecting DVD player

Using three separate component video cables, connect the DVD players' related jacks to Y, C<sub>B</sub> and C<sub>R</sub> jacks on the projection TV.

#### 1. DVD player with COMPONENT SIGNAL OUT terminals

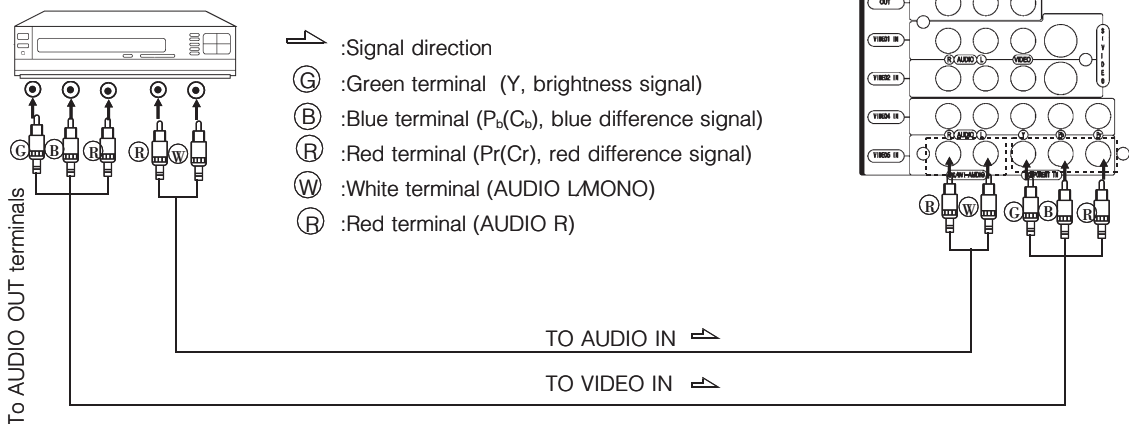

# EXTERNAL EQUIPMENT CONNECTION

## A/V INPUT (continued)

### 2. Connecting a DVD player with A / V Connectors

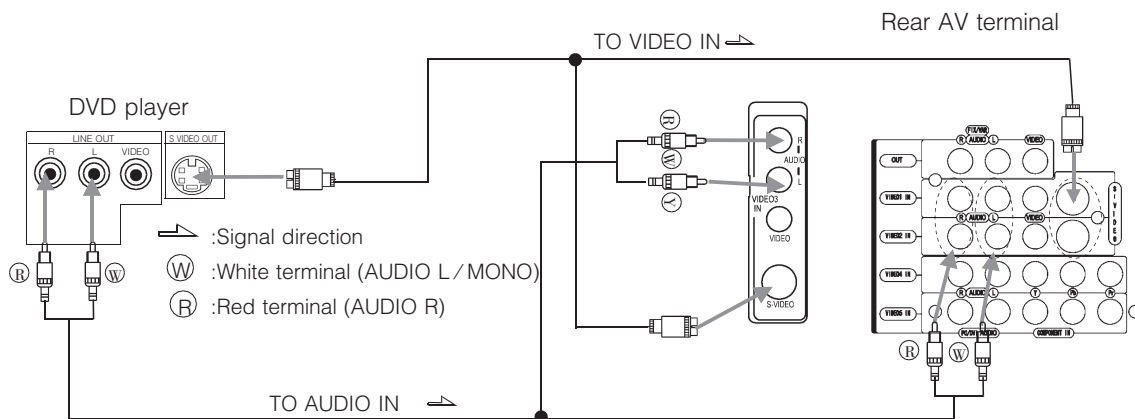

## Digital HD monitor—receiver

The projection TV has Y, Pb, Pr jacks for HD TV signal, and can receive HD signals of 480p, 480i, 720p and 1080i. The picture is sharper and more vivid than that when receiving component signal. Disconnect all power before making any connections.

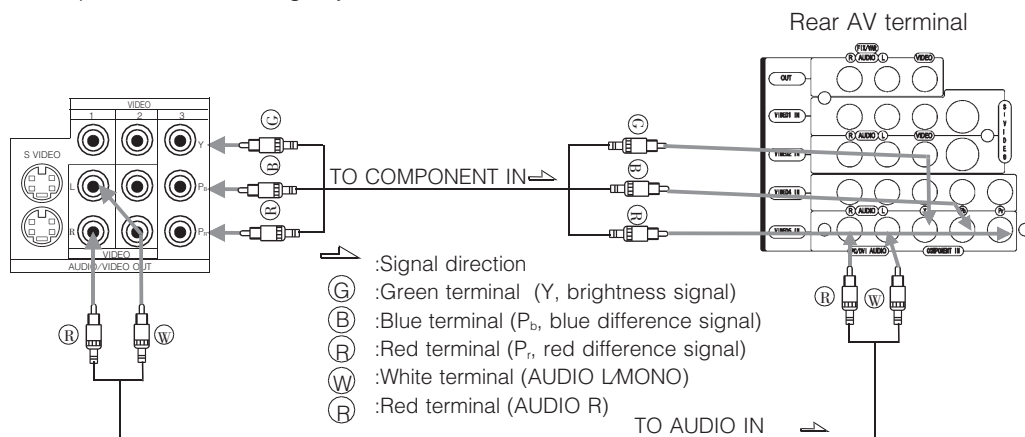

※If your HDTV has both VIDEO OUT and S-VIDEO OUT terminals, you can also connect them to the corresponding IN terminal of the PTV.

# EXTERNAL EQUIPMENT CONNECTION

## PC INPUT

Connect computer's PC OUT to PC IN jack of the projection TV.

### Procedure:

1 Disconnect all power sources before making any connections.



2 Using PC cables and audio jacks, connect computer with the projection TV.

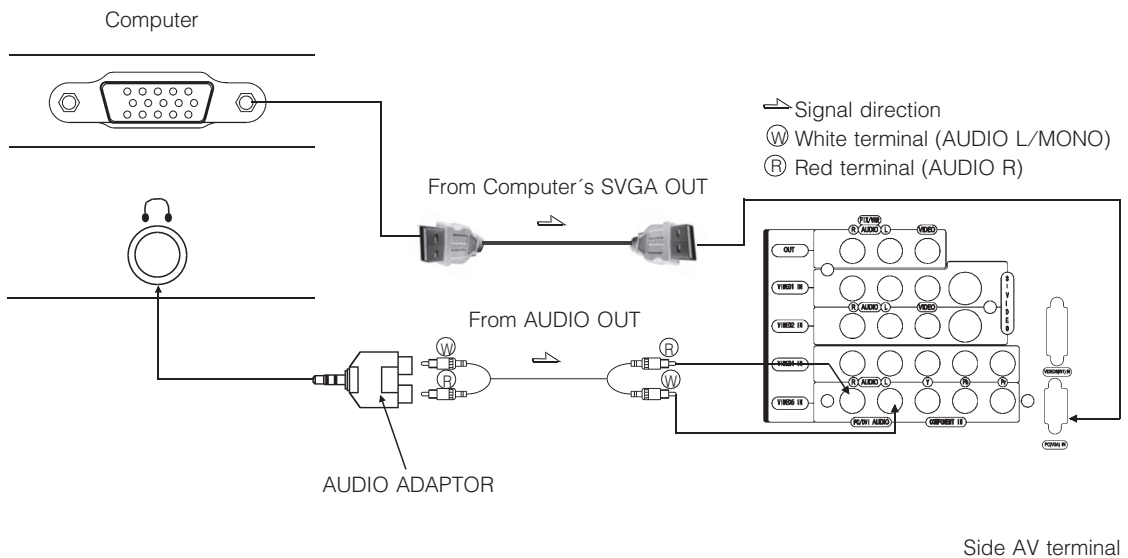

- ※ The connection figure is for reference purpose only due to different computer audio output modes.
- ※ When using audio jacks, insert left/right audio cables into AV2 audio jack or side audio jack.
- ※ Audio adaptor is optional.
- ※ Do not pull out PC cable when the projection TV is in power.

# EXTERNAL EQUIPMENT CONNECTION

## PC INPUT (continued)

1 Identify and receive 10 kinds of signal formats: 640×480@ 60/75/85/Hz, 800×600@ 60/75/85Hz, 1024×768@ 60/75/85/Hz, 720×400@70Hz.

### Operation and adjustment

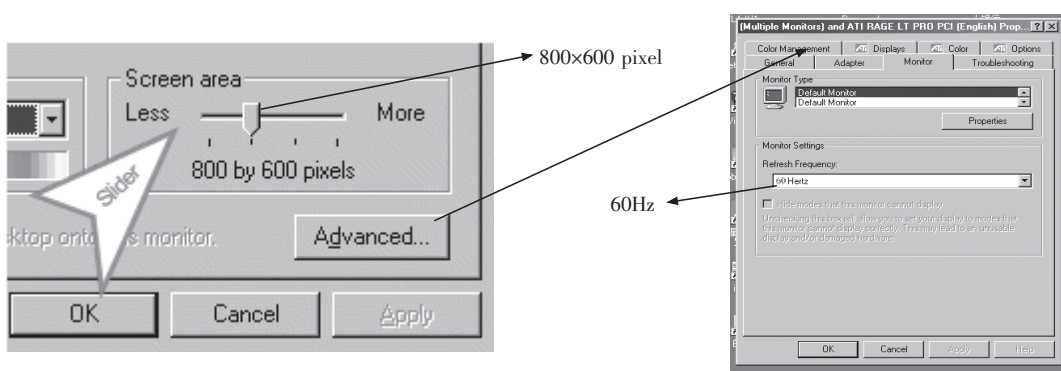

※ Turn the computer on, the recommended display mode is 800X600, and refresh rate to 60Hz.



※ The above figure is for reference purpose only due to different computer.

2 Turn the projection TV on, and press PC or AV to enter the PC mode.

The projection TV identifies the input signals after entering the PC mode. The projection TV will display the following information if the signals are not the signal formats that the TV identified.

3 Press **PICTURE**  to zoom in or zoom out the pictures in PC mode, Press **DISPLAY**  to display the current status of the projection TV. Press "PICTURE" to adjust the picture quality. Press MENU to call up VIDEO menu to adjust picture.



# EXTERNAL EQUIPMENT CONNECTION

## DVI Input

### Connection

- 1、 Cut off all equipments' power supply before connection.
- 2、 Connect DTV and DVI terminal in the set with special cable and audio line separately.

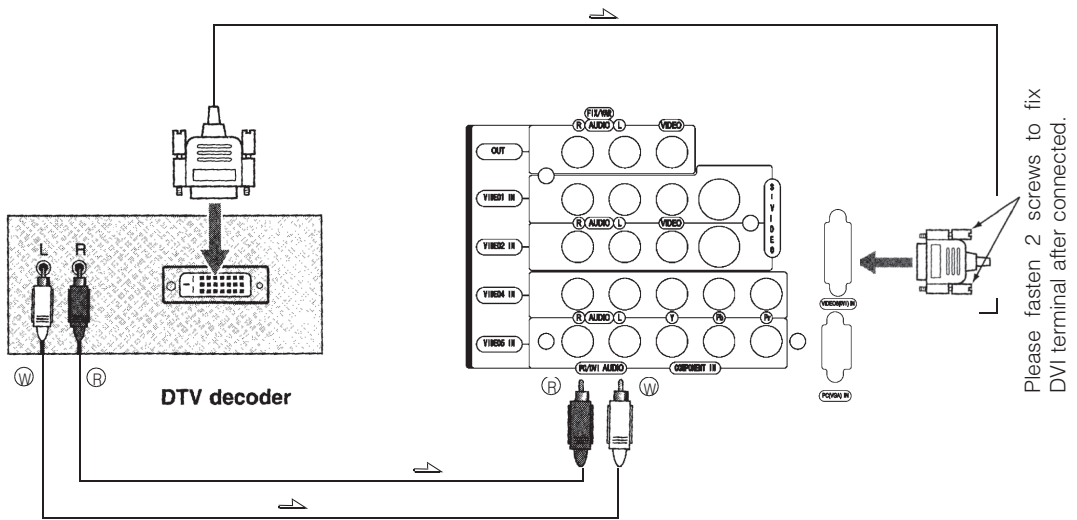

- ※ The audio connection of the picture is for reference only.
- ※ Please inset L/R audio signal lines into rear component audio terminal when using audio terminals.

### Using and adjusting

- 1、 Can receive 480P, 800\*600@60Hz, 576P signals.
- 2、 Press DVI or AV button to enter DVI mode.

- ※ Do not insert or unplug the special cable line in power on status.



---

# EXTERNAL EQUIPMENT CONNECTION

## Operation and adjustment

• Press AV to scroll through the following modes after completion of connections:

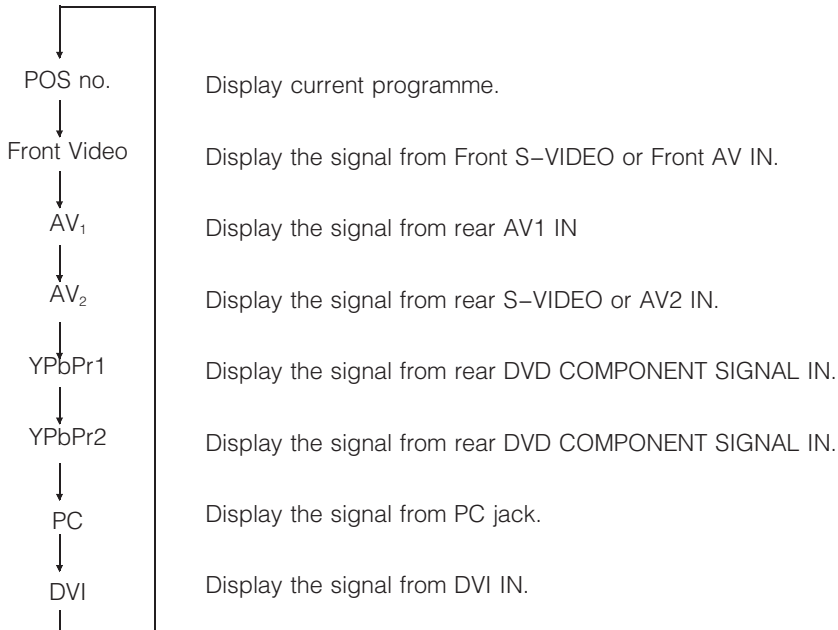

※ If the picture is abnormal, re-select color system or set it to AUTO.

※ If connects S-VIDEO and AV at the same time. The signal from S-VIDEO is in priority.

# TROUBLESHOOTING

• Before calling service personnel, please check the following chart for a possible cause to the trouble you are experiencing.

Symptom	Check these things
No power supply	• Make sure the power cord is plugged in.
Poor color/hue	• May be the misadjustment for contrast, color and hue.
Spots appear on the screen.	• May be jamming from cars, motorcycles, electric trains, high tension lines, neon signs, hair dryers, etc.
Stripes appear on the screen.	• May be jamming from other TV receivers, personal computers, and TV games as well as interference from radio station.
Double or triple images	• May be caused by reflection from nearby mountains or buildings. • Check if the direction of the antenna has changed because of strong wind, etc.
Snowy picture	• Check the antenna/cable connections. • Check if the direction of the antenna has changed.
Abnormal color or no picture	• May be due to improper fast power-on. Power off the projection TV, then power it on again.
The remote control does not work.	• The batteries in the remote control may be exhausted. • Check the orientation of the batteries.

# SPECIFICATIONS AND ACCESSORIES

Rated voltage	100–240V~, 50/60Hz
Rated power consumption	About 250W
Dimensions (W)×(H)×(D) (mm)	1132mm×1094mm×449mm (Approx.)
Weight	40kg (Approx.)
Effective screen size (W)×(H) (mm)	1036mm×777mm (Approx.)
Channel Coverage	VHF:C1~C12 UHF:C13~C57 CATV:Z1~Z37
Color system	PAL, NTSC, PAL60, SECAM
Sound system	D/K, I, M, B/G
Audio output	10W+10W (THD=7%)
Accessories supplied	Operation manual Remote control AAA alkaline batteries (2) Warranty card





JUT6.491.1088



## Free Manuals Download Website

<http://myh66.com>

<http://usermanuals.us>

<http://www.somanuals.com>

<http://www.4manuals.cc>

<http://www.manual-lib.com>

<http://www.404manual.com>

<http://www.luxmanual.com>

<http://aubethermostatmanual.com>

Golf course search by state

<http://golfingnear.com>

Email search by domain

<http://emailbydomain.com>

Auto manuals search

<http://auto.somanuals.com>

TV manuals search

<http://tv.somanuals.com>