

INSTRUCTION MANUAL  
FOR  
DIGITAL BLOOD PRESSURE MONITOR

REF **CH-462E**

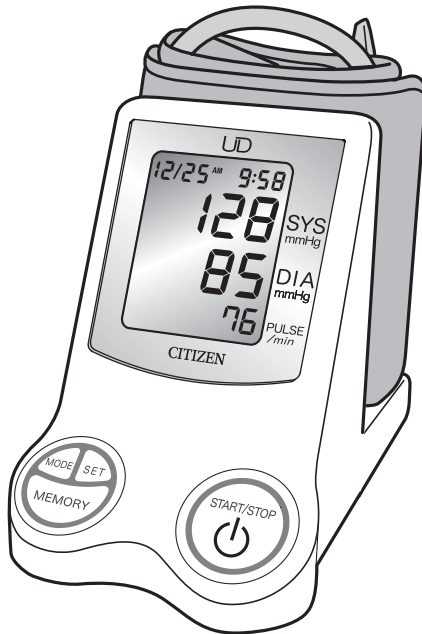

English

## Contents

- 3 - GENERAL REMARKS
- 5 - PRECAUTIONS FOR USE AND MAINTENANCE
- 8 - UNIVERSAL DESIGN
- 9 - IDENTIFICATIONS OF PARTS
- 10 - LOADING THE BATTERIES
- 11 - USING AC ADAPTER (OPTION)
- 12 - REMOVING THE BATTERIES
- 12 - RESETTING OPERATION
- 13 - SETTING THE CLOCK
- 17 - MEASURING YOUR BLOOD PRESSURE
- 19 - TIPS FOR OBTAINING ACCURATE MEASUREMENTS
- 23 - AUTOMATIC CHANGEOVER FEATURE
- 23 - HOW TO CALL UP THE VALUES STORED IN MEMORY TO THE DISPLAY
- 24 - HOW TO CALL UP THE DATA STORED IN MEMORY
- 25 - HOW TO DELETE THE DATA STORED IN MEMORY
- 26 - KEY TO DISPLAY ICONS
- 27 - ABOUT "BLOOD PRESSURE"
- 28 - BLOOD PRESSURE Q&A
- 29 - BEFORE REQUESTING REPAIRS OR TESTING
- 30 - SPECIFICATIONS

**Ensure that you have all the following components**



Blood pressure  
monitor unit

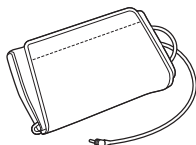

Arm Cuff



(for monitor)  
4 AA-size  
batteries



Instruction  
Manual



Pouch

# GENERAL REMARKS

## General remarks on blood pressure and blood pressure measurement

1. To deflate the cuff quickly, press the "START/STOP" switch.
2. The attached cuff is suitable for arm circumferences of 20-32 cm.
3. When attaching the cuff, the air hose should be placed on the inside of your arm on top of the artery.
4. Self measurement is not therapy! In no event should you change the dosage of your medication prescribed by your physician.
5. As preparation for measuring your blood pressure, you should urinate and then remain relatively still for 10 to 15 minutes prior to measurement.
6. Exercising, eating, drinking, smoking, etc., prior to measurement may affect the results.
7. Your blood pressure varies constantly throughout the day. Measurements should be taken regularly at the same time each day.
8. DO NOT place too much emphasis on the results of one measurement. Keep a continuing record of your blood pressure variations. A complete picture can only be obtained from a large number of readings.
9. Emotional stress tends to cause your blood pressure to rise.

## To obtain correct blood pressure measurements

1. Take five or six deep breaths and then relax before measuring your blood pressure. If you are tense when taking the measurement, you will not get a valid reading.
2. Your blood pressure will be elevated if you are anxious or irritated, suffering from lack of sleep or constipation, or have just taken some exercise or eaten a meal.
3. Wrap the cuff around your arm and tighten it so that one finger can be inserted between the cuff and arm. (  See page 18)
4. DO NOT measure your blood pressure after bathing or drinking.
5. If you feel the need to urinate, do so before measuring your blood pressure.
6. Measure your blood pressure where the room temperature is around 20°C. DO NOT measure your blood pressure when it is too cold (below 10°C) or too hot (above 40°C) in the room.
7. DO NOT try to measure your blood pressure immediately after drinking coffee or tea or after smoking.
8. Measure your blood pressure when you are relaxed and still. Keep the center of the cuff at the level of your heart and DO NOT move your arm or talk.

## GENERAL REMARKS

- DO NOT measure blood pressure when the cuff has been on your arm for a few minutes or more. During this time, your arm will have built up a higher blood pressure and you will not get valid reading.
- The figure below shows the blood pressure classifications under the WHO standards.

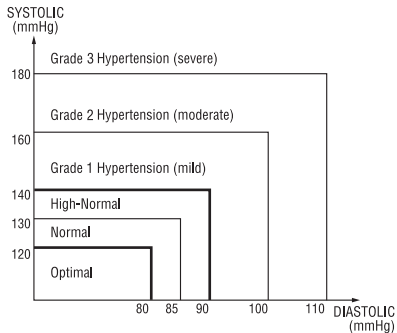

### Remarks:

The graph is not exact, but may be used as a guide in understanding non-invasive blood pressure measurements. The device is only intended for use with adults.

### Definitions and Classifications of Blood Pressure Levels

#### Measure your blood pressure at the same time each day.

- \* Your blood pressure changes all the time. This means that data gathered over a long period has far more significance than data from just one measurement. For this reason, you must measure your blood pressure on a daily basis. Ideally, you should measure your blood pressure at the same time each day wherever possible.

# PRECAUTIONS FOR USE AND MAINTENANCE

## Precautions for use

1. If you suffer from heart disease, high blood pressure or other circulatory disease, consult your physician before using the monitor.
2. If the cuff pressure feels abnormal or you experience any other irregularity while using the cuff, reduce the pressure immediately by pressing the "START/STOP" switch and then consult the sales outlet where you purchased the monitor.
3. If you think the measurement is abnormal or if measurement makes you feel unwell, discontinue use and consult your physician.
4. Blood pressure measurement may not be possible for anyone with a weak pulse or arrhythmia.
5. Repeated blood pressure measurement may cause problems such as congestion or swelling in some people.
6. Frequently repeated blood pressure measurements will not give accurate results. Allow an interval of about 10 minutes between measurements.
7. If you suffer from a severe problem with blood circulation in your arms, consult your physician before using the monitor. Failure to do so could be hazardous to your health.
8. Measurement may not be possible for anyone with insufficient blood flow to the area where measurements will be taken or who suffers from a frequent irregular heartbeat. Consult your physician for advice on whether to use the monitor.
9. DO NOT wrap the cuff around an injured arm.
10. DO NOT wrap the cuff around an arm in which a drip (intravenous infusion) is inserted or which is being used for blood transfusion as part of medical treatment. Doing so could result in an injury or a serious accident.
11. DO NOT use the monitor in the vicinity of flammable gases such as those used for anaesthesia. Doing so could ignite the gases and cause an explosion.
12. DO NOT use the monitor in enriched oxygen environments such as a hospital's hyperbaric chamber or oxygen tent. Doing so could ignite the oxygen and cause a fire.
13. DO NOT use mobile phones near the monitor as this could result in a malfunction.
14. If you use a cardiac pacemaker, consult your physician before using the monitor.

## PRECAUTIONS FOR USE AND MAINTENANCE

15. Be sure to use this unit only for measuring blood pressure. DO NOT use it for any other purpose.
16. DO NOT use this unit on infants.
17. Blood pressure measurement may not be possible for anyone with common arrhythmias such as atrial or ventricular premature beats or atrial fibrillation.

### Maintenance Precautions

1. DO NOT store the blood pressure monitor in locations exposed to direct sunlight, high temperatures (over 60°C), low temperatures (below -20°C), high relative humidity (over 95%) or excessive amounts of dust.
2. DO NOT drop the blood pressure monitor or subject it to other shocks or vibration.
3. Remove the batteries if the monitor will be left unused for a long period.
4. DO NOT attempt to disassemble the monitor.
5. DO NOT deform the cuff or bend the air hose excessively.
6. If the monitor is very dirty, wipe it clean with a cloth moistened with sterilizing alcohol or a neutral detergent. Then wipe it with a dry cloth.
7. NEVER clean the blood pressure monitor with thinners or benzene, as this could damage the monitor.
8. To clean the cuff, wipe it with a moist cloth. Avoid hard rubbing as this will cause air leakages. Take care also not to get water into the air hose.

### Symbols Explanation:

 0086 Device complies with the requirements of the EC Directive 93/42/EEC. Registered with the CE Marking.

 : Type B applied part

 : Attention, consult accompanying documents.

 : Appliance compliance WEEE directive

 : Manufacturer

**LOT** : Batch Code



### Warning

The device has been tested and homologated in accordance with EN60601-1-2 for EMC. This does not guarantee in any way that the device will not be affected by electromagnetic interference. Avoid using the device in high electromagnetic environment.

### Nature and frequency of maintenance:

This product is designed for use over an extended period of time; however, it is generally recommended that it be inspected every two years to ensure proper function and performance.

### Protect the nature environment:

Please help to protect natural environment by respecting national and/or local recycling regulations when disposing of the battery and the product at the end of their useful live.

### WEEE MARK

If you want to dispose this product, do not mix with general household waste. There is a separate collection systems for used electronics products in accordance with legislation under the WEEE Directive (Directive 2002/96/EC) and is effective only within European Union.



### Reference European standard:

The blood pressure measuring device corresponds to regulation EN60601-1-2.

### Calibration:

The blood pressure measuring device is generally recommended to have the monitor inspected every two years to ensure correct functioning and accuracy. Please contact a distributor.



CITIZEN SYSTEMS(H.K.) LIMITED  
 FLAT A-B, 4TH FLOOR, HUNG MOU INDUSTRIAL  
 BUILDING, 62 HUNG TO ROAD, KWUN TONG,  
 KOWLOON, HONG KONG

### European Representative:

Name : WwW elektronische Geräte Vertrieb GmbH  
 Address : Fintelmannstraße, 20/Eingang, Martin-Heydert-Straße,  
 D-14109 Berlin, Germany

\*For technical data, please contact our European Representative.



# UNIVERSAL DESIGN

This product has been developed with the concept of Universal Design to ensure safe and easy use for a broader range of users. The product's shape and color was designed to portray "warmth" and "gentleness" and have functional qualities that compliment the human body, which make it "easy to understand," "safe to use," and "easy to use."

English





# IDENTIFICATION OF PARTS

## Component names

### Main Unit

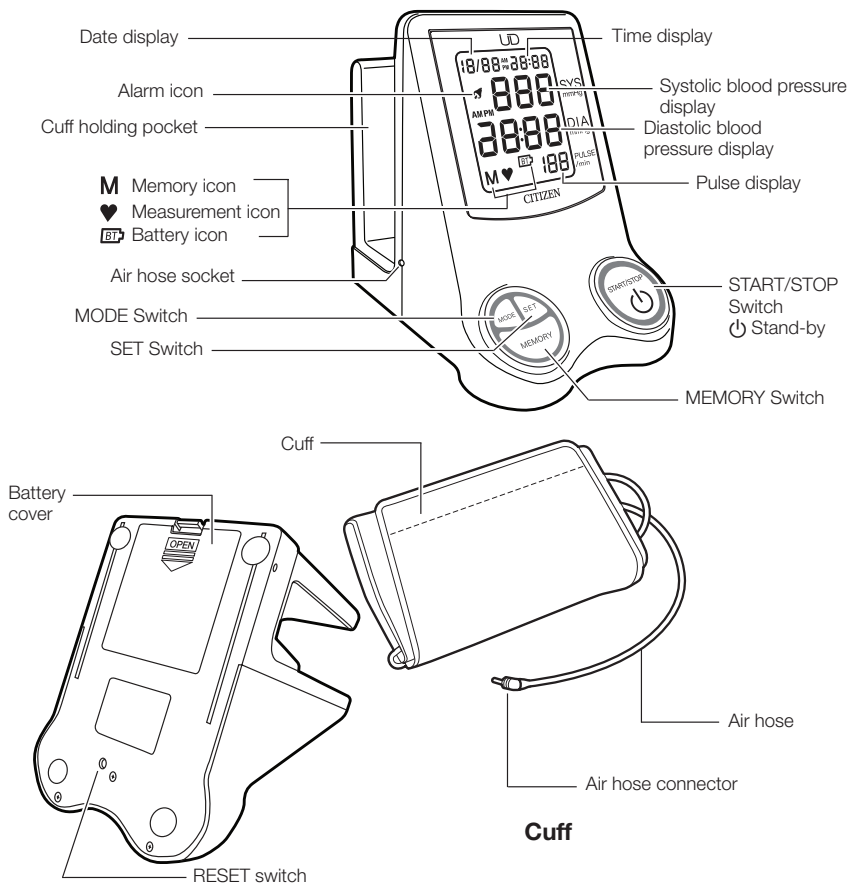

# LOADING THE BATTERIES

(Batteries supplied with the unit should be loaded in compartment before putting the Blood pressure monitor in use.)

English

## 1 Open the cover of battery compartment.

Pressing the hook down, pull the cover toward you to open.

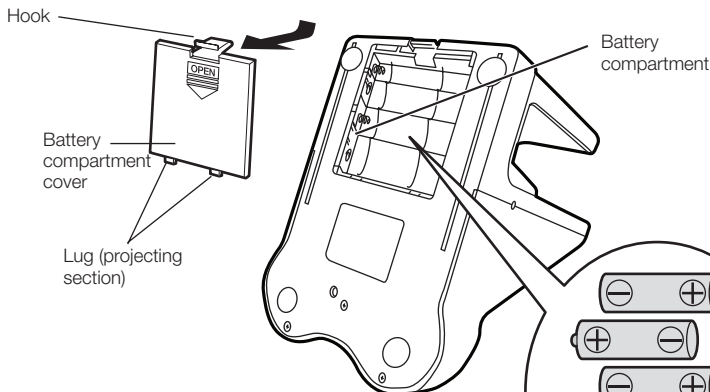

## 2 Place batteries in the compartment.

Put the batteries paying attention to the positive and negative terminal symbols  $\oplus$  and  $\ominus$ .

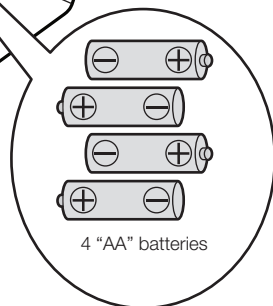

## 3 Close the battery compartment cover.

\* If the Blood pressure monitor is left unused for an extended period of time, the batteries should be removed from the compartment.

Fitting the lugs of the cover at the mating recesses of the battery compartment body, push the hook to close the cover.

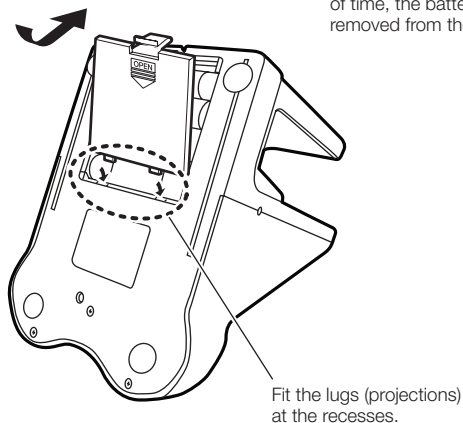

## USING AC ADAPTER (OPTION)

Using the optional dedicated AC adapter for the CITIZEN blood pressure monitor (CH-462E) allows you to measure your blood pressure without having to worry about the amount of remaining charge in the batteries.

- 1. Insert the AC adapter plug into the socket on the blood pressure monitor.**
- 2. Plug the AC adapter into a mains power outlet.**

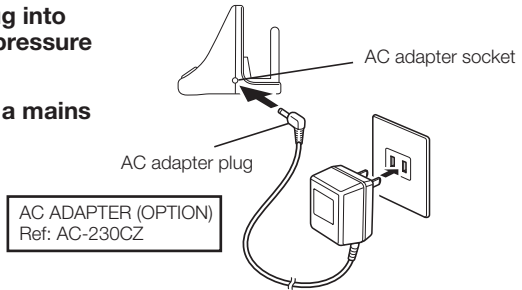

- If you plan to use the AC adapter for an extended period of time, remove the batteries. If the batteries are left in the compartment, electrolyte may leak from the batteries and cause a fault in the blood pressure monitor.
- If the AC adapter is used as the only power supply for the monitor, unplugging the AC adapter will erase the data stored in the monitor's memory. It is recommended that you make a note of any important data .
- When only batteries are used to supply power to the monitor, the AC adapter should be unplugged from the monitor. Leaving the AC adapter plugged into the blood pressure monitor could cause a malfunction.

The dedicated AC adapter for the CH-462E is optional.  
The AC adapter is available from retailers stocking CITIZEN digital blood pressure monitors.

## REMOVING THE BATTERIES

- When the icon  is displayed, or where the clock is no longer shown or nothing appears in the display, replace the old batteries with four new ones. All four batteries should be changed at once.
- The memory is erased if the batteries are removed for replacement. It is recommended to make note of the data stored in memory prior to changing batteries.
- Do not use rechargeable batteries.
- Do not use alkaline and manganese batteries together.
- The monitor is powered by the batteries provided. Note that they may not last as long as indicated.
- Batteries included are for demonstration purposes only. Battery life maybe shorter than specified.
- When disposing of used batteries, comply with governmental regulations or environmental public institution's rules that apply in your country /area.

## RESETTING OPERATION

- When you put the Blood pressure monitor in use for the first time, be sure to press the RESET switch mounted on the back of the main unit to reset after loading the batteries in the compartment.
- If the main unit fails to work normally while it is in use, the normal state may be restored to the unit by carrying out resetting operation.
- Resetting operation erases the entire data in memory. The clock will re-start from 12:00am on January 1, 2007.

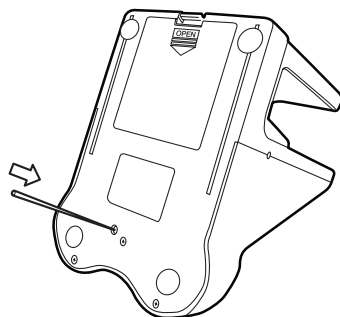

# SETTING THE CLOCK

- 1 Initial state. (When you load the batteries in the unit for the first time, carry out the reset procedure.)**



\* Date/hour/alarm setting when the batteries are first loaded into the unit.

**Data and time: 12:00 am, January 1, 2007**  
**Alarm: 12:00 am, alarm is in OFF state**

## 2 Date and time correcting procedure

The alarm time, current time and calendar should be set in the written order.

- Each time you press the “MODE” switch, the data item to be modified changes in the sequence shown below. The selected item flashes on and off.

**1. Alarm, minute → 2. Alarm, hour → 3. Second → 4. Minutes → 5. Hour → 6. Year → 7. Month → 8. Day of month → 9. Time system (12-hour or 24-hour system)**

- Press “SET” switch to increase the indicated value in increments of one. Hold down the “SET” switch on to advance the setting continuously.
- The aforementioned switch performance will not be carried out for the correction of “3) Second” and “9) Time system (12-hour or 24-hour system).”
- After the completion of correction of all items as required, press “START/STOP” switch to restore the time indication to the display.

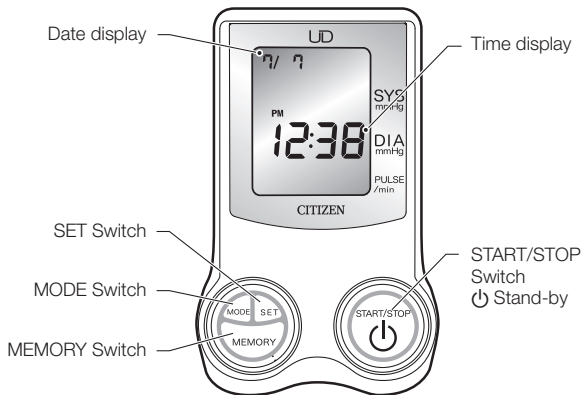

### 3 Correcting the “minute” of an alarm time



- Press “MODE” switch for one second or more to place the unit in the alarm-time minute correction state.
- Press “SET” switch to increase the minute of the alarm time in increments of one minute.

### 4 Correcting the “hour” of an alarm time



- After the completion of the alarm-time minute correction as described above, press “MODE” switch to place the unit in the alarm-time hour correction state.
- Press “SET” switch to increase the hour of the alarm time in increments of one hour.

### 5 Correcting the “second” of the current time



- After the completion of the alarm-time hour correction as described above, press “MODE” switch to place the unit in the current-time second correction state.
- Press “SET” switch to reset the second indication to 00. Press “SET” switch according to a time signal. Note that the minute indication on the display will advance when the seconds given is 30 to 59 seconds of a minute.

### 6 Correcting the “minute” of the current time

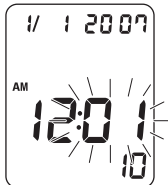

- After the completion of the current-time second correction as described above, press “MODE” switch to place the unit in the current-time minute correction state.
- Press “SET” switch to increase the minute of the current time in increments of one minute.

## 7 Correcting the “hour” of the current time



- After the completion of the current-time minute correction as described above, press “MODE” switch to place the unit in the current-time hour correction state.
- Press “SET” switch to increase the hour of the current time in increments of one hour.

## 8 Correcting the “year”



- After the completion of the current-time hour correction as described above, press “MODE” switch to place the unit in the year correction state.
- Press “SET” switch to increase the year of the current time in increments of one year.
- The year can be set in the range of 2007 and 2036.

## 9 Correcting the “month”



- After the completion of the year correction as described above, press “MODE” switch to place the unit in the month correction state.
- Press “SET” switch to increase the month of the current time in increments of one month.

## 10 Correcting the “day of the month”



- After the completion of the month correction as described above, press “MODE” switch to place the unit in the day-of-the-month correction state.
- Press “SET” switch to increase the day of the month of the current time in increments of one day.

## 11 Changeover of the “time system”



- After the completion of the day-of-the-month correction as described above, press “MODE” switch to place the unit in the time system selection state.
- Every time “SET” switch is pressed, the 12-hour system (12H) and (24H) will be changed over.
- Press “MODE” switch after activating the time system indication on the display to revert the display to the time indication. This completes the clock setting procedure.

## 12 How to set the alarm

- While the alarm symbol  is shown on the display, the alarm will sound for 30 seconds when the alarm time is reached. The alarm sounds only when the time indication is shown on the display.
- To stop the alarm, press any switch.
- To change over the alarm status between SET/RELEASE, press “SET” switch while the time indication is shown on the display.

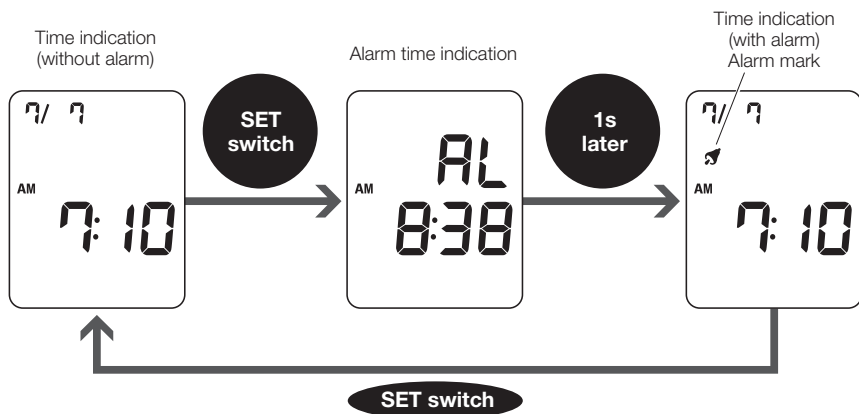



# MEASURING YOUR BLOOD PRESSURE

## 1 ATTACHING THE ARM CUFF

- 1 Unroll the arm cuff and thread the end through the metal hoop so that the side with the Velcro patch is on the outside.

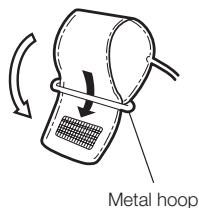

- 2 Put the arm cuff around your arm so that the blue marker comes to the palm side.

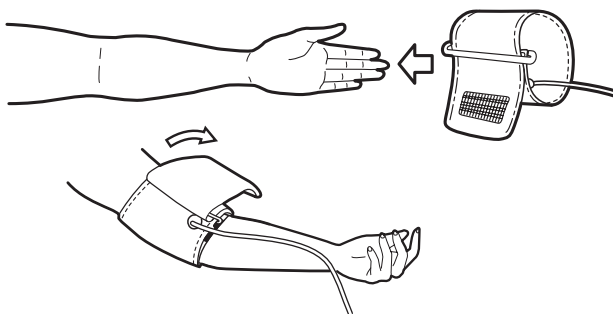

- 3 Adjust the position of the arm cuff so that the blue marker is located in the center of your arm and the hem of the cuff is 1 to 2 cm above your elbow.

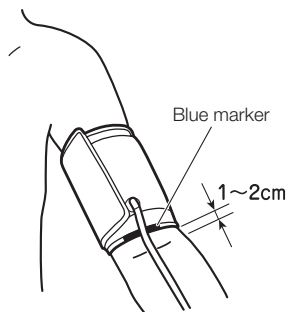

- \* The cuff should be put on the bare arm or over a light-weight underwear.
- \* If you wear a heavy-weight top, please remove it.

- 4** Pull the end of the arm cuff outwards so that the cuff is snug around your arm and then secure the end to the Velcro.

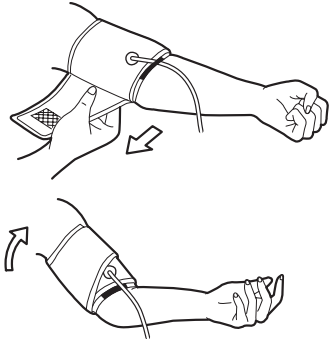

- 5** Place your arm on a table or the like so that the center of the cuff comes to the height of your heart.

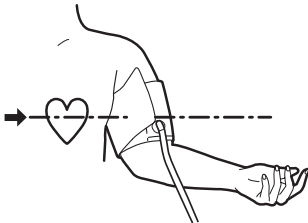

\* Carefully place the cuff on your arm, taking care to use the correct tightness. The tightness is correct if you can readily slide a finger between the cuff and your arm.



- 6** Relax your arm and lightly open the palm upward.

# TIPS FOR OBTAINING ACCURATE MEASUREMENTS

Your blood pressure varies according to your posture, the time of day and a range of other factors. Ideally, you should measure your blood pressure in the same posture at the same time every day.

## ■ Taking measurements while sitting

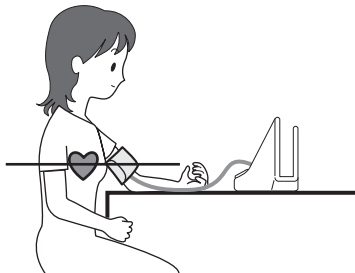

- ① Place your arm on a table or similar surface with your forearm extended.
- ② It is important to have the arm cuff level with your heart.
- ③ Open your hand slightly on the table so that your palm is facing up and your fingers are relaxed.
- ④ Do not move your body or talk while taking the measurement.

## ■ Measurement in laying posture

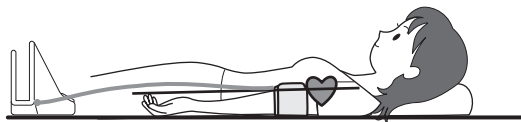

\* Relax yourself not to apply pressure to the arm cuff.

- ① Lie down your head facing the ceiling.
- ② Lightly open your hand with palm up and straighten your arm.
- ③ Relax your body, arm and fingers.
- ④ Do not move your body or talk during measurement.

## ■ You may use your right arm to measure your blood pressure.

Blood pressure rate is likely to differ by as much as 10mmHg when measured on the left arm instead of the right (or vice-versa). Measure your blood pressure on the same arm each day.

## 2 Plug the air hose connector into the main unit.

- Plug the air hose connector firmly into the air hose socket on the main unit as illustrated.

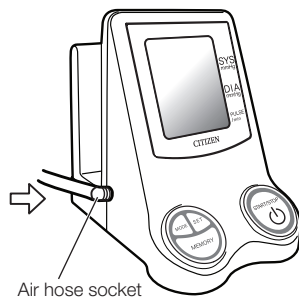

## 3 Start measurement.

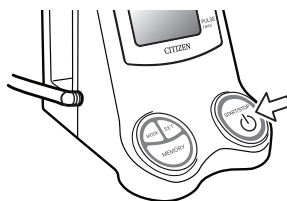
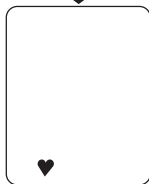

- Press the "START/STOP" switch.
- All of the segment will be displayed.
- The ♥ mark comes on.
- The ♥ mark goes out. Now, the pump activates.

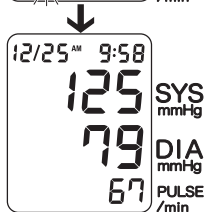
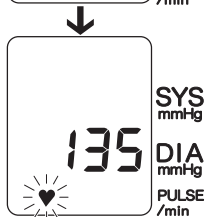
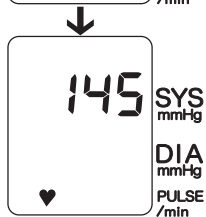
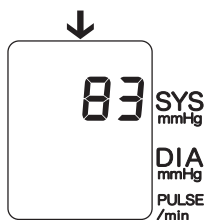

- The Blood pressure monitor automatically carries out pressurization until the pressure that is best suited to the blood pressure measurement is reached.
- When the unit determines that an adequate pressure is not obtained, the unit starts pressurization again.

- Wait a while after the completion of pressurization. Then, the ♥ mark comes on and the unit automatically starts measuring your blood pressures.

- When the unit detects your pulse, the ♥ mark flashes on and off, then the unit gives your blood pressure value on the lower section of the display.

- Upon completion of measurement, the buzzer sounds and the unit automatically exhausts air from the cuff. Then, the Systolic blood pressure/Diastolic blood pressure/pulse will appear on display.
- As long as the unit functions correctly, the blood pressure and the pulse rate for the result with the record of the time and date are automatically stored in memory as one set of data.
- Up to 60 sets of measurement data can be stored in the memory. If you measure your blood pressure when 60 sets of measurements have already been stored in memory, the earliest set of measurements is automatically deleted to make way for the new measurements.

### [Manual pressurization]

- Keep “START/STOP” switch held pressed until the pressure value you want to stop pressurization is reached (approximately 40mmHg higher than the Systolic blood pressure). You can stop pressurization by the unit by releasing the switch at the aforementioned value is reached. The upper pressure limit is 280mmHg.

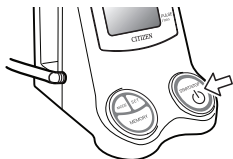

### 4 Revert the display to the time indication.

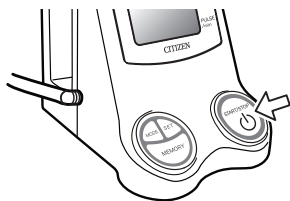

- Press “START/STOP” switch to revert the display to the time indication.
- \* When you want to stop measurement, press “START/STOP” switch. The air in the cuff is exhausted to stop measurement.

### 5 Store the cuff in the pocket.

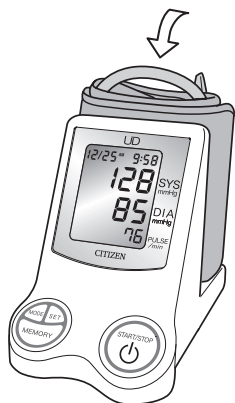

- Wrap the air hose lightly on the cuff with the air hose connector inserted into the main unit. Then, put it in the cuff pocket.
- Place the unit as a clock, at such a location that you can observe the display easily.

# AUTOMATIC CHANGEOVER FEATURE

- Press “START/STOP” switch after the completion of blood pressure measurement to revert the display to the time display. If you do not press the switch and leave the unit, the “Automatic changeover feature” of the unit will work approximately three minutes later to automatically revert the display to the time indication. If you leave the unit for three minutes without performing operations, the display will automatically changeover to the time indication.

## HOW TO CALL UP THE VALUES STORED IN MEMORY TO THE DISPLAY

- Except for the case where the unit is engaged in measurement, press “MEMORY” switch to call up the values (measurement results) stored in memory to the display.
- The value stored in memory is numbered in the order of measurements. For example, when 60 sets of data are stored in memory, the data number 1 represents the latest data.

**Data number: 1, 2, 3 ...**



The latest data

**... 59, 60**



The earliest data

- The number of measurements that can be stored in memory is 60 sets. Then, when storing 61st data in memory, the 1st data stored in memory will be automatically deleted. In this way, the unit automatically delete data stored in memory in order of storage to accept new data.
- If you press “MEMORY” switch with no data stored in memory, the clock indication will remain on the display.

# HOW TO CALL UP THE DATA STORED IN MEMORY

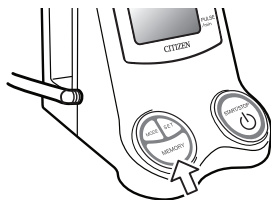

- Press the “MEMORY” switch.

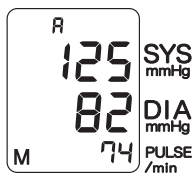

- “A” that represents the average value appears on the upper left section of the display. Then, the average of the whole data stored in memory appears on the display.

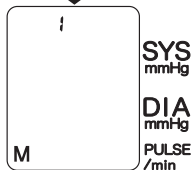

- Press the “MEMORY” switch again. This recalls and displays first the memory number and then the last set of data stored.



- Press the “MEMORY” switch again. This recalls and displays the second last set of data stored. Each time you press this switch, the unit displays the data prior to the last set of data displayed.

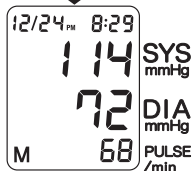
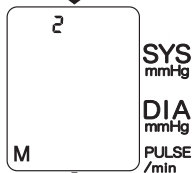





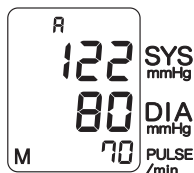
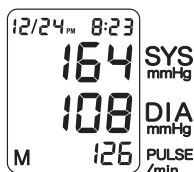

## HOW TO DELETE THE DATA STORED IN MEMORY



- The data stored in memory can be deleted.
- Press “MEMORY” switch to call up the data you want to delete to the display. Keep the switch held pressed for three seconds or more to delete the data. Then, the buzzer sounds to let you know the completion of deletion of the data.
- After the completion of data deletion, the average value of the whole data stored in memory will appear on the display. When all sets of data stored in memory are deleted to leave no data to be shown on the display, the unit will return the display to the state (the time or measurement result indication) before “MEMORY” switch is pressed.

# KEY TO DISPLAY ICONS

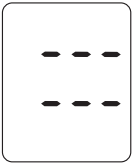
Icon displayed	Condition/Cause	Corrective action
	<p>Insufficient pressure.</p>	<p>Repeat measurement again.</p>
	<p>Appears when the blood-pressure could not be measured accurately.</p>	<p>Reapply cuff properly and measure again.</p>
	<p>The pressure is 281 mmHg or higher.</p>	<p>If the pressure does not automatically decline during measurement, immediately press the "START/STOP" switch and turn the unit off. To take the measurement again, refer to P.21 and correctly re-apply pressure.</p>
	<p>Appears when the batteries are running low.</p>	<p>Replace the batteries.</p>
	<p>Detected problem in the device.</p>	<p>Ask purchased store.</p>

# ABOUT "BLOOD PRESSURE"

## What is blood pressure?

The heart is a pump that circulates blood throughout your body. Blood is pumped from the heart at a constant pressure into arteries. This pressure is called the arterial blood pressure and represents, in general terms, your blood pressure. Blood pressure is indicated by several kinds of pressures, including the systolic pressure that occurs when the heart pumps blood and the diastolic pressure that occurs when blood returns to the heart.

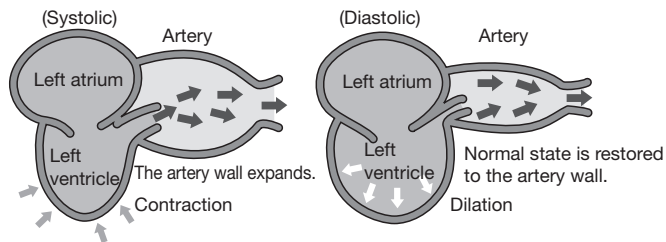

## Your blood pressure changes all the time.

Your blood pressure differs according to your age, gender and a range of other factors. It is likely to be affected by your biorhythm during the day and by your posture, physical activities, mental activities, level of stress and even by the air temperature. The blood pressure of a healthy person generally varies within a day.

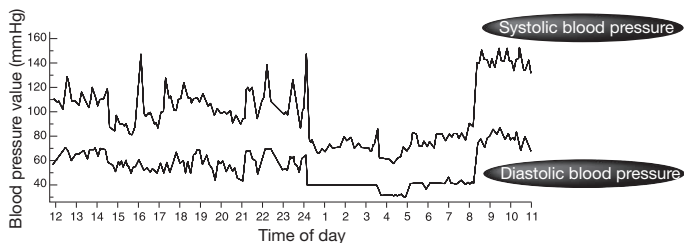

## BLOOD PRESSURE Q&A



- Q** Why is the blood pressure measured at home different from that measured by the physician or at a hospital?
- A** Your blood pressure may vary due to exercise, the ambient temperature or your mental state. When you have a physician or nurse measure your blood pressure, the pressure value is likely to be 10 to 20 mmHg higher than usual due to anxiety and/or stress. Knowing what affects your blood pressure helps you to better monitor your health.
- Q** Why does the blood pressure obtained vary with measurement?
- A** Our blood pressure is adjusted by the function of automatic nerve. Blood pressure differs with every heart beat. We are likely to think that our blood pressure is constant, but it varies if you take measurements in repetition. Blood pressure is susceptible to the time of day, such as forenoon and afternoon, season and atmospheric temperature. In addition, blood pressure is easily affected by mental stress or emotional ups and downs. It tends to increase when you feel tension or decrease when you are relaxed.
- Q** What is the benefit of measuring my blood pressure at home?
- A** Blood pressure measurements taken at home give reliable data as they can be taken when you are in a stable and relaxed condition. Physicians place considerable importance on blood pressure measurements taken at home. You should measure your blood pressure at the same time each day and record the variations in your blood pressure.



Always consult your physician for an interpretation of your blood pressure readings and to determine the proper treatment.

## BEFORE REQUESTING REPAIRS OR TESTING

Make sure to check the following before sending your blood pressure monitor away to be tested or repaired.

Problem	Checks	Response
Display stays blank when you press the "START/STOP" switch.	Check whether the batteries are dead.	Replace all the batteries with new ones.
	Check whether the batteries are installed the right way round ( $\oplus$ and $\ominus$ oriented correctly).	Load the batteries in the correct direction.
No measurements can be taken.	Check whether the measurement icon  is displayed.	Attach the arm cuff properly.
	Check whether the arm cuff is applied correctly.	
	Did you stay calm during measurement?	Measure your blood pressure again, making sure to remain still.
	Note that blood pressure measurement may not be possible for someone with an extremely weak pulse or cardiac arrhythmia (irregular pulses).	
Your blood pressure readings are abnormally high or low compared with those taken in hospital.		 See page 28.
Other phenomena		Remove the batteries from the unit and change them with new ones.

# SPECIFICATIONS

Model Number:		CH-462E	
Measurement system:		Oscillometric method	
Measurement Localization		Upper Arm	
Cuff:		soft cuff	
Arm circumference range:		20.0 to 32.0 cm	
Measurement range:	Pressure	0 to 280 mmHg	
	Pulse	40 to 180 pulse/min	
	Pressure	±3 mmHg	
Accuracy:	Pulse	±5% of reading	
	Clock	±20 second/Month	
	Pressure	3 digits	
LCD displays:	Pulse	3 digits	
	Date	4 digits	
	Time	4 digits with AM/PM mark	
	Icons	M: Memory icon, ♥: Measurement icon, ⚡: Alarm icon, 🔋: Battery icon	
Switch:		5 (START/STOP, MEMORY, MODE, SET, RESET)	
Inflation:		Automatic Inflation by internal pump	
Deflation:		Automatic speed deflation system controlled by internal electromagnetic valve.	
Rated voltage:		6V --- 3W (--- : direct current)	
Exhaust:		Electromagnetic quick exhaust valve	
Power supply:		4 AA batteries (LR6) or optional AC/DC adapter (6V DC, 0.6A)	
Battery duration:	Alkaline	Approx. 500 times	(170 mmHg, once/day, 22°C)
	Manganese	Approx. 150 times	
Automatic changeover function:		Approx. 3 min. (after activated)	
Memory capacity:		60 sets of data including date and time	
Dimensions:		112(W) x 148(D) x 152(H) mm	
Weight:		Approx. 520g w/o batteries cuff: approx. 140g	
Operating conditions:	Temperature	10°C to 40°C	
	Humidity	30% to 85% RH	
Storage conditions:	Temperature	-20°C to 60°C	
	Humidity	10% to 95%RH	
Electric shock protection:		Internal power unit	
Safety Classification:		⚡ Type B Equipment	
Mode of operation:		Continuous operation	
Protection against ingress of water:		IPX0	
Accessories		Set includes an arm cuff, 4 AA batteries for the monitor (LR6), Instruction Manual, pouch.	

- CITIZEN is a registered trademark of Citizen Holdings Co., Japan.  
CITIZEN es una marca registrada de Citizen Holdings Co., Japón.  
“CITIZEN”和“西铁城”是日本法人西铁城控股株式会社の注册商标
- Design and Specification are subject to change without notice.

---

### **CITIZEN SYSTEMS JAPAN CO., LTD.**

6-1-12, Tanashi-cho, Nishi-Tokyo-Shi,  
Tokyo 188-8511, Japan  
E-mail: [sales-oe@systems.citizen.co.jp](mailto:sales-oe@systems.citizen.co.jp)  
<http://www.citizen-systems.co.jp/>

## Free Manuals Download Website

<http://myh66.com>

<http://usermanuals.us>

<http://www.somanuals.com>

<http://www.4manuals.cc>

<http://www.manual-lib.com>

<http://www.404manual.com>

<http://www.luxmanual.com>

<http://aubethermostatmanual.com>

Golf course search by state

<http://golfingnear.com>

Email search by domain

<http://emailbydomain.com>

Auto manuals search

<http://auto.somanuals.com>

TV manuals search

<http://tv.somanuals.com>