

DB255

CD RECEIVER
 •
 RÉCEPTEUR CD
 •
 RECEPTOR CD

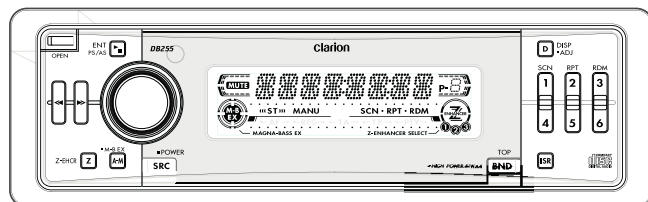

Contents

1. FEATURES	2
2. CONTROLS	3
SOURCE UNIT	3
DISPLAY	3
3. BUTTON TERMINOLOGY	4
Names of the Buttons and their Functions	4
4. PRECAUTIONS	5
Flip Down Panel	6
Handling Compact Discs	6
5. DCP (Detachable Control Panel)	7
6. REMOTE CONTROL	8
Functions of Remote Control Unit Buttons	9
7. OPERATIONS	10
Basic Operations	10
Radio Mode Operations	12
CD Mode Operations	13
8. TROUBLESHOOTING	14
9. ERROR DISPLAYS	14
10. SPECIFICATIONS	15

1. FEATURES

- High Visibility & Contrast Blue Negative Display (13 x 8 Digits) with Screen Saver
- CD-R/RW Playability
- High Power 51W X 4 Built in Amplifier
- 2 ch RCA Output
- Remote Control and DCP Case Included
- Detachable Flip-Down Faceplate
- Z-Enhancer and Magna Bass EX for Sound Adjustment
- "Easy to Use" Rotary Volume Knob

Be sure to unfold and read the next page.
 Veuillez déployer et vous référer à la page suivante.
 Cerciórese de desplegar y de leer la página siguiente.

2. CONTROLS / COMMANDES / CONTROLES

Note : Be sure to unfold this page and refer to the front diagrams as you read each chapter.
Remarque : Veuillez déployer cette page et vous référer aux schémas quand vous lisez chaque chapitre.
Nota : Cuando lea los capítulos, despliegue esta página y consulte los diagramas.

SOURCE UNIT / APPAREIL PILOTE / UNIDAD FUENTE

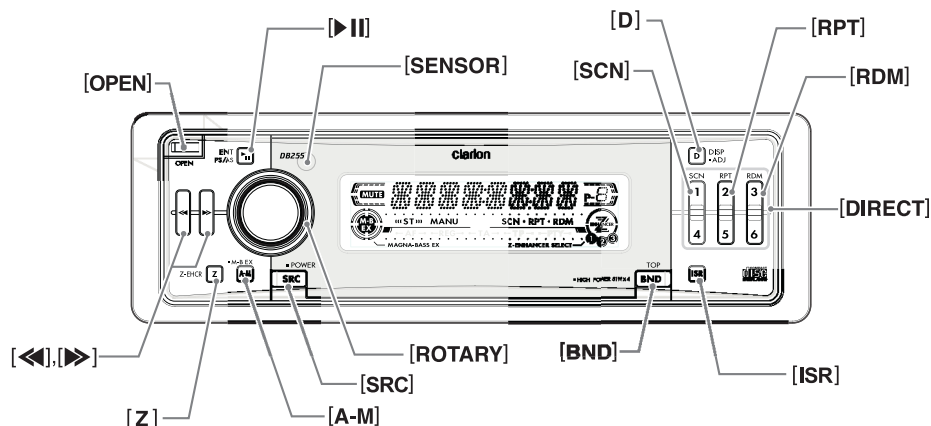

With the FLIP DOWN PANEL opened / Ouvrez le PANNEAU RABATTABLE / Apertura del PANEL ABATIBLE

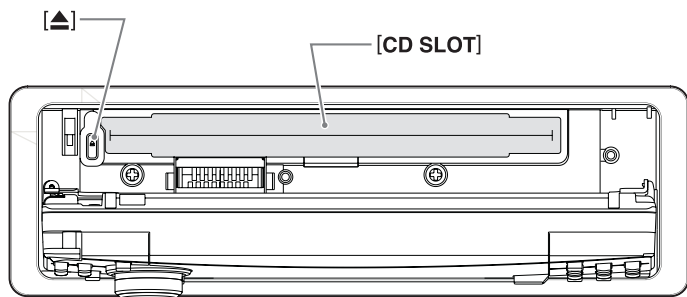

DISPLAY / AFFICHEUR / VISUALIZADOR

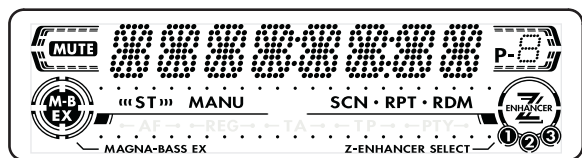

3. BUTTON TERMINOLOGY

Note:
 • Be sure to read this chapter referring to the front diagrams of chapter "2. CONTROLS" on page 3.

Names of the Buttons and their Functions

[OPEN] button

- Deeply push in [OPEN] button to unlock the flip down panel.

[▶||] button

- Plays or pauses a CD while in the CD mode.
- Performs preset scan while in the radio mode. When the button is pressed and held, auto store is performed.

[SENSOR] button

- Receiver for remote control unit.
- Operating range: 30° in all directions.

[D] button

- Switch the display indication (Main display, clock display).

[SCN] button

- Performs scan play for 10 seconds for each track while in the CD mode.

[RPT] button

- Plays repeatedly while in the CD mode.

[RDM] button

- Performs random play while in the CD mode.

[DIRECT] button

- Stores a station into memory or recall it directly while in the radio mode.

[ISR] button

- Recalls ISR radio station in memory.
- Press and hold for 2 seconds or longer: Stores current station into ISR memory (radio mode only).

[BND] button

- Switches the band, or seek tuning or manual tuning while in the radio mode.
- Plays a first track while in the CD mode.

[ROTARY] knob

- Adjust the volume by turning the knob clockwise or counterclockwise.
- Use the knob to perform various settings.

[SRC] button

- Press the button to turn on the power. Press and hold the button for 1 second or longer to turn off the power.
- Switches the operation mode among radio and CD mode.

[A-M] button

- Press and hold the button for 1 second or longer to switch the MAGNA BASS EX on/off.
- Use the button to switch to the audio mode (bass, treble, balance, fader)

[Z] button

- Use the button to select one of the three types of sound characteristics already stored in memory. (Z-Enhancer)

[◀], [▶] button

- Selects a station while in the radio mode or selects a track when listening to a CD.
- Press and hold the button for 1 second or longer to switches the fast-forward/fast-backward.

[▲] button

- Ejects a CD when it is loaded into the unit.

[CD SLOT]

- CD insertion slot.

4. PRECAUTIONS

1. When the inside of the car is very cold and the player is used soon after switching on the heater, moisture may form on the disc or the optical parts of the player and proper playback may not be possible. If moisture forms on the disc, wipe it off with a soft cloth. If moisture forms on the optical parts of the player, do not use the player for about one hour and the condensation will disappear naturally to allow normal operation.
2. Driving on extremely bumpy roads which cause severe vibration may cause the sound to skip.
3. This unit uses a precision mechanism. Even in the event that trouble arises, never open the case, disassemble the unit, or lubricate the rotating parts.

This equipment has been tested and found to comply with the limits for a Class B digital device, pursuant to Part 15 of the FCC Rules.

These limits are designed to provide reasonable protection against harmful interference in a residential installation.

This equipment generates, uses, and can radiate radio frequency energy and, if not installed and used in accordance with the instructions, may cause harmful interference to radio communications. However, there is no guarantee that interference will not occur in a particular installation.

If this equipment does cause harmful interference to radio or television reception, which can be determined by turning the equipment off and on, the user is encouraged to consult the dealer or an experienced radio/TV technician for help.



CAUTION

USE OF CONTROLS, ADJUSTMENTS, OR PERFORMANCE OF PROCEDURES OTHER THAN THOSE SPECIFIED HEREIN, MAY RESULT IN HAZARDOUS RADIATION EXPOSURE.

THE COMPACT DISC PLAYER SHOULD NOT BE ADJUSTED OR REPAIRED BY ANYONE EXCEPT PROPERLY QUALIFIED SERVICE PERSONNEL.

INFORMATION FOR USERS:

CHANGES OR MODIFICATIONS TO THIS PRODUCT NOT APPROVED BY THE MANUFACTURER WILL VOID THE WARRANTY AND WILL VIOLATE FCC APPROVAL.

MODEL

DB255

clarion

12V \ominus GROUND

AM 530-1710kHz/FM 87.9-107.9MHz

THIS DEVICE COMPLIES WITH PART 15 OF THE FCC RULES. OPERATION IS SUBJECT TO THE FOLLOWING TWO CONDITIONS :
 (1) THIS DEVICE MAY NOT CAUSE HARMFUL INTERFERENCE, AND
 (2) THIS DEVICE MUST ACCEPT ANY INTERFERENCE RECEIVED, INCLUDING INTERFERENCE THAT MAY CAUSE UNDESIRABLE OPERATION.

THIS PRODUCTION COMPLIES WITH DHHS RULES 21 CFR SUBCHAPTER J APPLICABLE AT DATE OF MANUFACTURE.

CLARION CO.,LTD.
 50 KAMITODA , TODA-SHI, SAITAMA-KEN, JAPAN.

MANUFACTURED:

SERIAL No.
 PE-2739B

286-6552-00
 Clarion Co.,Ltd.
 MADE IN MALAYSIA

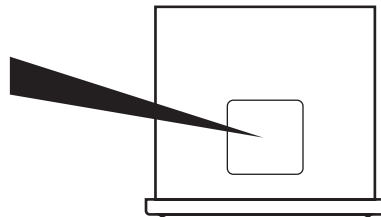

Bottom View of Source Unit

Flip Down Panel

This unit uses a flip-down structure that makes possible large-size displays.

⚠ CAUTION

When opening and closing the FLIP DOWN PANEL, be careful not to catch your fingers. They could be injured.

1. Always use this unit with the FLIP DOWN PANEL closed.
2. Do not force operations or use this device abnormally when opening or closing the FLIP DOWN PANEL.
3. Do not use the FLIP DOWN PANEL as a tray to place objects on when it is open.
4. When closing the FLIP DOWN PANEL, do not press the **[OPEN]** button.
5. Strong impacts to the operating or display section can cause damage or deformation.
6. If the FLIP DOWN PANEL does not open fully, gently open it with your hand.

Handling Compact Discs

Use only compact discs bearing the  mark. Do not play heart-shaped, octagonal, or other specially shaped compact discs.

Some CDs recorded in CD-R/CD-RW mode may not be usable.

Handling

- Compared to ordinary music CDs, CD-R and CD-RW discs are both easily affected by high temperature and humidity and some of CD-R and CD-RW discs may not be played. Therefore, do not leave them for a long time in the car.
- New discs may have some roughness around the edges. If such discs are used, the player may not work or the sound may skip. Use a ball-point pen or the like to remove any roughness from the edge of the disc.

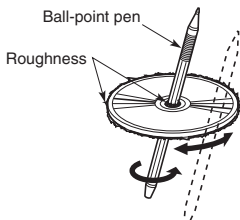

- Never stick labels on the surface of the compact disc or mark the surface with a pencil or pen.
- Never play a compact disc with any cellophane tape or other glue on it or with peeling off marks. If you try to play such a compact disc, you may not be able to get it back out of the CD player or it may damage the CD player.

- Do not use compact discs that have large scratches, are misshapen, cracked, etc. Use of such discs may cause misoperation or damage.
- To remove a compact disc from its storage case, press down on the center of the case and lift the disc out, holding it carefully by the edges.
- Do not use commercially available CD protection sheets or discs equipped with stabilizers, etc. These may damage the disc or cause breakdown of the internal mechanism.

Storage

- Do not expose compact discs to direct sunlight or any heat source.
- Do not expose compact discs to excess humidity or dust.
- Do not expose compact discs to direct heat from heaters.

Cleaning

- To remove fingermarks and dust, use a soft cloth and wipe in a straight line from the center of the compact disc to the circumference.
- Do not use any solvents, such as commercially available cleaners, anti-static spray, or thinner to clean compact discs.
- After using special compact disc cleaner, let the compact disc dry off well before playing it.

5. DCP (Detachable Control Panel)

The control panel can be detached to prevent theft. When detaching the control panel, store it in the DCP (Detachable Control Panel) case to prevent scratches.

We recommend taking the DCP with you when leaving the car.

Removing the DCP

1. Press the **[SRC]** button for 1 second or longer to switch off the power.

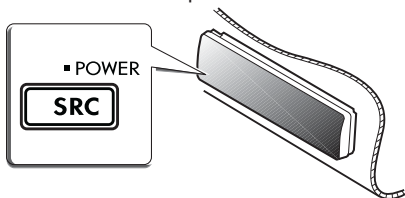

2. Press in the **[OPEN]** button.

* If the flip down panel does not open fully, gently open it with your hand.

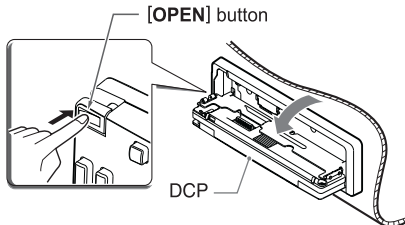

3. Pull the DCP toward you and remove it.

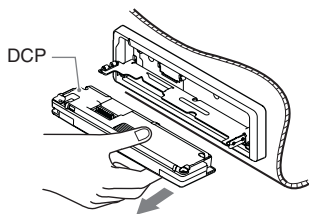

4. Close the **HOLD FLAP**.

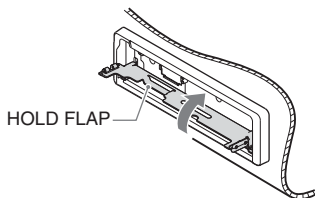

CAUTION

Be sure to close the HOLD FLAP for safety when removing the DCP.

Attaching the DCP

1. Insert the right side of the DCP into the main unit.
2. Insert the left side of the DCP into the main unit.

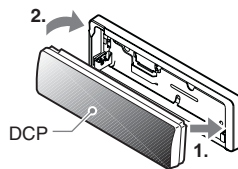

CAUTION

- The DCP can easily be damaged by shocks. After removing it, be careful not to drop it or subject it to strong shocks.
- If the FLIP DOWN PANEL is kept open, the DCP may drop due to vibration of the car. This results in damage to the DCP. So close the FLIP DOWN PANEL or remove the DCP to store into the case.
- The connector connecting the main unit and the DCP is an extremely important part. Be careful not to damage it by pressing on it with fingernails, pens, screwdrivers, etc.

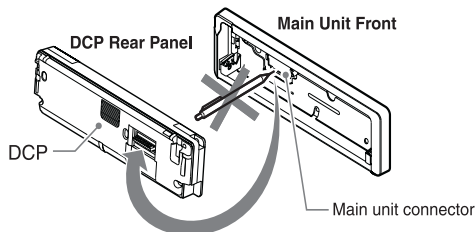

Note:

- If the DCP is dirty, wipe off the dirt with a soft, dry cloth only.

6. REMOTE CONTROL

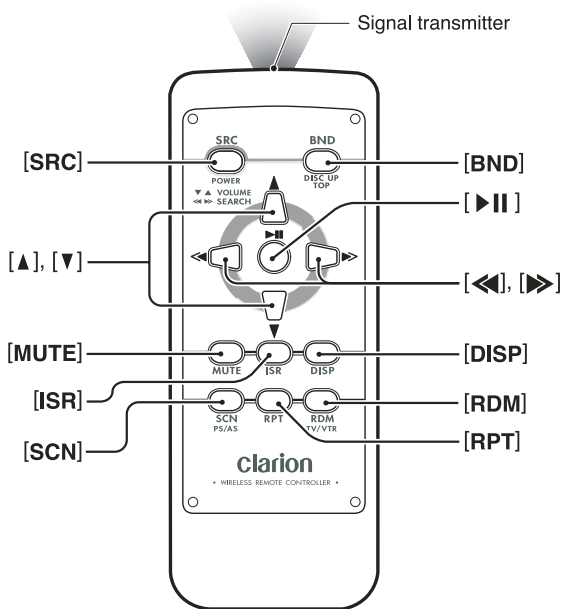

Inserting the Battery

1. Turn over the remote control unit and slide the cover in the direction indicated by the arrow in the illustration.
2. Insert the battery (CR2025) into the insertion guides, with the printed side (+) facing upwards.
3. Press the battery in the direction indicated by the arrow so that it slides into the compartment.
4. Replace the cover and slide in until it clicks into place.

Notes:

Misuse may result in rupture of the battery, producing leakage of fluid and resulting in personal injury or damage to surrounding materials. Always follow these safety precautions:

- Use only the designated battery .
- When replacing the battery, insert properly, with +/ - polarities oriented correctly.
- Do not subject battery to heat, or dispose of in fire or water. Do not attempt to disassemble the battery.
- Dispose of used batteries properly.

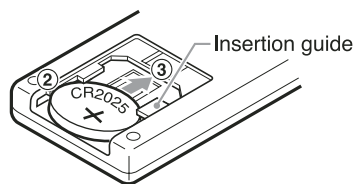
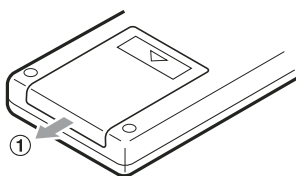

Functions of Remote Control Unit Buttons

Mode Button	Radio	CD
[SRC]	Turns power on and off. When press and held for 1 second: Turns power off. Switches between radio and CD.	
[BND]	Switches reception band.	Plays the first track. Top play.
[▲], [▼]	Increases and decreases volume (in all modes).	
[◀], [▶]	Moves preset channels up and down.	Moves tracks up and down. When pressed and held for 1 second: Fast-forward/fast-backward.
[MUTE]	Turns mute on and off	Switches between playback and pause.
[MUTE]	Turns mute on and off.	Switches between playback and pause.
[ISR]	Recalls ISR radio station in memory. Press and hold for 2 seconds or longer: Stores current station into ISR (radio mode only).	
[DISP]	Switches among main display, clock display.	
[SCN]	Preset scan. When pressed and held for 1 second: Auto store.	Scan play.
[RPT]	No function	Repeat play.
[RDM]	No function	Random play.

* Some of the corresponding buttons on the main unit and remote control unit have different functions.

7. OPERATIONS

Basic Operations

Note: Be sure to read this chapter referring to the front diagrams of chapter "2. CONTROLS" on page 3.

⚠ CAUTION

Be sure to lower the volume before switching off the unit power or the ignition key. The unit remembers its last volume setting. If you switch the power off with the volume up, when you switch the power back on, the sudden loud volume may hurt your hearing and damage the unit.

Turning on/off the power

Note:

- Be careful about using this unit for a long time without running the engine. If you drain the car's battery too far, you may not be able to start the engine and this can reduce the service life of the battery.
1. Press the [SRC] button.
 2. The illumination and display on the unit light up. The unit automatically remembers its last operation mode and will automatically switch to display that mode.
 3. Press and hold the [SRC] button for 1 second or longer to turn off the power for the unit.

Selecting a mode

1. Press the [SRC] button to change the operation mode.
2. Each time you press the [SRC] button, the operation mode changes in the following order:
Radio mode → CD mode → Radio mode...

Note:

- If the CD mode is selected when no disc is inserted, the display shows "NO DISC".

Adjusting the volume

Turning the [ROTARY] knob clockwise increases the volume; turning it counterclockwise decreases the volume.

- * The volume level is from 0 (minimum) to 33 (maximum).

Setting the Z-Enhancer

This unit are provided with 3 types of sound tone effects stored in memory. Select the one you prefer.

- * The factory default setting is Z-EHCR OFF.

Each time you press the [Z] button, the tone effect changes in the following order:

Z-ENHANCER 1 → Z-ENHANCER 2 → Z-ENHANCER 3 → Z-EHCR OFF → Z-ENHANCER 1...

- Z-ENHANCER 1 : bass emphasized
- Z-ENHANCER 2 : treble emphasized
- Z-ENHANCER 3 : bass and treble emphasized
- Z-EHCR OFF : no sound effect

Audio mode adjustments

Press the [A-M] button to select the adjustment mode. The mode switches as follows each time the [A-M] button is pressed:

BASS → TREB → BAL → FAD → Previous mode

- * The display returns to the previous mode 7 seconds after the adjustment.

Adjusting the bass

1. Press the [A-M] button and select "BASS".
2. Turning the [ROTARY] knob clockwise emphasizes the bass; turning it counterclockwise attenuates the bass.
* The factory default setting is "0". (Adjustment range: -7 to +7)

Adjusting the treble

1. Press the [A-M] button and select "TREB".
2. Turning the [ROTARY] knob clockwise emphasizes the treble; turning it counterclockwise attenuates the treble.
* The factory default setting is "0". (Adjustment range: -7 to +7)

Basic Operations

Adjusting the balance

1. Press the **[A-M]** button and select "**BAL**".
2. Turning the **[ROTARY]** knob clockwise emphasizes the sound from the right speaker; turning it counterclockwise emphasizes the sound from the left speaker.
 - * The factory default setting is "**0**". (Adjustment range: L13 to R13)

Adjusting the fader

1. Press the **[A-M]** button and select "**FAD**".
2. Turning the **[ROTARY]** knob clockwise emphasizes the sound from the front speakers; turning it counterclockwise emphasizes the sound from the rear speakers.
 - * The factory default setting is "**0**". (Adjustment range: F12 to R12)

Note:

- Bass and Treble can only be adjusted when the "**Z-enhancer**" is off.

Turning on/off MAGNA BASS EX

The MAGNA BASS EX does not adjust the low sound area like the normal sound adjustment function, but emphasizes the deep bass sound area to provide you with a dynamic sound.

- * The factory default setting is off.

Press and hold the **[A-M]** button for 1 second or longer to turn the MAGNA BASS EX and "**M-B EX**" in the display lights on or off.

Switching display

Press and hold the **[BND]** button, and then press the **[DISP]** button to select the desired display.

The display switches in the following order:

Main Display → Clock Display → Main Display ...

- * If the display is changed by other button operation when the clock is displayed, the clock display returns automatically after the operation.

Illumination dimmer function

When the illumination line of this unit is connected with the car-side illumination signal line, the display illumination of this unit dims in connection with turning on the car-side illumination.

ADJ mode adjustment

1. Press **[D]** button more than 1 second at POWER ON mode to enter ADJ mode, the previous selected ADJ items will be called out.
2. Press **[D]** button again at ADJ mode will cancel ADJ mode and return to previous display.
3. Press **[SRC]** button will also release ADJ mode.
4. ADJ mode will also be released when current source mode is changed. (Mode changes of LOADING, EJECT, interruption and interruption release)
5. Press **[◀]/[▶]** button to switch the ADJ mode items,

→ CLOCK(E) ↔ SCRNR SVR ←
6. The ADJ Mode Title will be display for 2 seconds before showing the ADJ Mode setting.

Adjusting clock setting

1. Press the **[D]** button and press **[◀]/[▶]** button to select "**CLOCK (E)**".
2. Press **[▶||]** button to start clock adjustment, the HOUR is selected and blinking by default.
3. Press **[◀]/[▶]** button to toggle HOUR and MINUTE selection.
4. Turn the **[ROTARY]** knob clockwise to increase hour/minute or counterclockwise to decrease hour/minute.
5. Press **[▶||]** button to confirm the clock setting, the clock will blink for 2 seconds and return to "CLOCK(E)".

Note:

- If you remove the vehicle's battery for a check or repair, the clock will be reset, so you must set it again.

Adjusting screensaver setting

1. Press the **[D]** button and press **[◀]/[▶]** button to select "**SCRNR SVR**".
2. "**SS ON**" or "**SS OFF**" will be display after 2 seconds.
3. Turn the **[ROTARY]** knob clockwise to turn on the screensaver or counterclockwise to turn off the screensaver.
4. If Screensaver setting is set to on, Screensaver will be activated after 30 seconds of no key operation.

Radio Mode Operations

FM reception

For enhanced FM performance the **MAGI-TUNE®** tuner includes signal actuated stereo control and multipath noise reduction circuits.

Listening to the radio

1. Press the **[SRC]** button and select the radio mode. then the radio will be on.
2. To select a preset band, press the **[BND]** button, then select one of the preset bands such as FM1, FM2, FM3 or AM. Every time the **[BND]** button is pressed, the display will change as: F1→F2 →F3 →AM →F1...
3. Press the **[◀]** or **[▶]** button to tune in the desired station.

Manual tuning

1. Press the **[BND]** button to select the desired band FM1, FM2, FM3 or AM.
2. Press and hold the **[BND]** button for 1 second or longer, then the "MANU" is lit in the display, which means that a manual selection function is on.
3. Press the **[◀]** or **[▶]** button to manually tune in a station.

Seek tuning

1. Press the **[BND]** button to select the desired band FM1, FM2, FM3 or AM.
2. If the "MANU" is lit in the display, press and hold the **[BND]** button for 1 second or longer. When the "MANU" display is off, the seek tuning is now available.
3. Press the **[◀]** or **[▶]** button to automatically seek in a station.

Preset memory function

Preset memory function can store up to 24 stations: six stations for each of FM1, FM2, FM3 and AM.

Manual memory function

1. Press the **[BND]** button, to select a band you want to store in the memory.
2. Press the **[◀]** or **[▶]** button to tune into a desired station.
3. Press and hold one of the **[DIRECT]** button for 2 seconds or longer to store the current station into preset memory.

Auto store function (Automatic Station Store)

1. Press **[BND]** button to select the desired band FM1, FM2, FM3 or AM.
2. Press and hold the **[▶||]** button for 1 second or longer. The stations at which the reception is the strongest will be automatically stored in the memory.

Notes:

- When the auto store is performed, the station previously store in the memory at that position is overwritten.
- When the number of stations stored is less than six, the previous content of the memory for each direct button will be retained.

Preset scanning (Preset Station Scan)

When the **[▶||]** button is pressed, the "SCN" will be indicated with preset memory numbers and the stations are tuned in for 7 seconds each in the order in which they were stored. Press the **[▶||]** button again to cancel the preset scanning mode.

Instant station recall (ISR)

With this function, a specific radio station can be recalled from any mode.

ISR memory

1. Press the **[SRC]** button, then select the radio mode.
2. Select the radio station which you want to store in the memory.
3. Press and hold the **[ISR]** button for 2 seconds or longer.

Recalling ISR

Press the **[ISR]** button and the display will show "ISR". Then the radio station previously memorized will be selected. Press the **[ISR]** button again to disengage the unit from the Recalling ISR function.

CD Mode Operations

Loading a CD

1. Press the [OPEN] button to access the CD SLOT behind the FLIP DOWN PANEL.
2. Insert a CD into the center of the CD SLOT with the label side facing up. The CD plays automatically after loading.

Notes:

- Never insert foreign objects into the CD SLOT.
- If the CD is not inserted easily, there maybe another CD in the mechanism or the unit may require service.
- Discs not bearing the  mark and CD-ROMs cannot be played by this unit.
- Some CDs recorded in CD-R/CD-RW mode may not be usable.

Loading 8cm compact discs:

- No adapter is required to play an 8cm CD.
 - Insert the 8cm CD into the centre of the insertion slot.
3. Close the FLIP DOWN PANEL.

CAUTION

Be careful not to catch your hand or fingers while closing the FLIP DOWN PANEL.

Notes:

- If the FLIP DOWN PANEL does not open fully, gently open with your hand.
- After loading a CD, always close the FLIP DOWN PANEL.

Listening to the disc already inserted

Press the [SRC] button to select the CD mode, the CD will start playing.

Stopping (Pausing) playback

While the CD playing pressing the [▶||] button will stop the CD and "PAUSE" indicate.

Press the [▶||] button again to resume playback.

Ejecting a CD

1. Press the [OPEN] button to open the FLIP DOWN PANEL.
2. Press the [▲] to eject the CD. Take it out from the ejected position.
3. Close the FLIP DOWN PANEL.
 - * If a CD (12cm) is left in the ejected position for 15 seconds, the CD is automatically reloaded (Auto reload).
 - * 8cm CDs are not auto reloaded. Be sure to remove them when ejected.

Notes:

- If you force a CD into before auto reloading, this can damage the CD.

Top function

Press the [BND] button, then the CD will start playing from the first song (track number 1).

Selecting tracks (Songs)

Press the [◀◀] or [▶▶] button.

- ▶▶ : Playback will start from the next track.
- ◀◀ : Playback will start from the beginning of the track currently playing. When this button is pressed again, the CD will play from the previous track.

Fast-forward and fast-backward

Press and hold the [◀◀] or [▶▶] button.

- ▶▶ : To fast-forward
- ◀◀ : To fast-backward

* For Audio CD mode pressing the [◀◀] or [▶▶] button for 1 second or longer will move forward or backward 5 times faster than normal play, and pressing it for 3 seconds or longer will do the operation 30 times faster.

Scan play (Intro Music Scan)

At Audio CD press the [SCN] button, the "SCN" is lit, then the CD will play the first 10 seconds of each track of the whole disc. Press the [SCN] button again to disengage the unit from scan play.

* A scan play will start from the track following the one currently playing.

Repeat play

At Audio CD press the [RPT] button, the "RPT" is lit, then the track currently playing will be played repeatedly. Press the [RPT] button again to disengage the unit from repeat play.

Random play

At Audio CD press the [RDM] button, the "RDM" is lit, then the entire tracks on the disc will be played at random. Press the [RDM] button again to disengage the unit from random play.

8. TROUBLESHOOTING

Problem	Cause	Solution
Power does not turn on. (No sound is produced)	Fuse is blown.	Replace with a fuse of the same amperage. If the fuse blows again, consult your store of purchase.
	Incorrect wiring.	Consult your store of purchase.
Compact disc cannot be loaded.	Another compact disc is already loaded.	Eject the compact disc before loading the new one.
Sound skips or is noisy.	Compact disc is dirty.	Clean the compact disc with a soft cloth.
	Compact disc is heavily scratched or warped.	Replace with a compact disc with no scratches.
Sound is bad directly after power is turned on.	Water droplets may form on the internal lens when the car is parked in a humid place.	Let dry for about 1 hour with the power on.
Nothing happens when button are pressed. Display is not accurate.	The microprocessor has malfunctioned due to noise, etc.	Turn off the power, then press the [OPEN] button and remove the DCP.
	DCP or main unit connectors are dirty.	Wipe the dirt off with a soft cloth moistened with cleaning alcohol.

9. ERROR DISPLAYS

- To protect the system, this unit has been equipped with self diagnostic functions. If a fault arises, a warning is issued by various error displays. Follow the corrective measures and remove the fault.

Error Display	Corrective Measure
ERROR 2	This error display indicates that a fault has arisen in the mechanism of the source unit (for example, the disc cannot be ejected). → Check the source unit.
ERROR 3	This error display indicates that the pickup focus is off because of a scratched disc or some other factor during source unit play. → Check the compact disc.
ERROR 6	This indicates that the CD's TOC (table of contents) cannot be read, for example because the selected disc is upside-down.

10. SPECIFICATIONS

FM tuner

Frequency Range: 87.9 MHz to 107.9 MHz
 Usable Sensitivity: 11 dBf
 50 dB Quieting Sensitivity: 17 dBf
 Alternate Channel Selectivity: 75 dB
 Stereo Separation (1 kHz): 35 dB
 Frequency Response (± 3 dB): 30 Hz to 15 kHz

AM tuner

Frequency Range:
 AM 530 kHz to 1710 kHz
 Usable Sensitivity: 25 μ V

CD player

System: Compact disc audio system
 Usable Discs: Compact disc
 Frequency Response: 10 Hz to 20 kHz (± 1 dB)
 Signal-to-Noise Ratio: 100 dB (1 kHz) IHF-A
 Dynamic Range: 95 dB (1 kHz)
 Harmonic Distortion: 0.01%

Audio

Maximum Power Output: 204 W (51 W X 4 ch)
 Continuous Average Power Output:
 17 W X 4, into 4 Ω , 20 Hz to 20 kHz, 1%THD
 Bass Control Action (100 Hz): ± 14 dB
 Treble Control Action (10 kHz): ± 14 dB
 Line Output (with A/C 1 kHz, 10 k Ω): 1.8 V

General

Power Supply Voltage:
 14.4 V DC (10.8 V to 15.6 V allowable), negative ground
 Current Consumption: Less than 15 A
 Speaker Impedance: 4 Ω (4 Ω to 8 Ω allowable)
 Weight: 2.42 lb. (1.1 kg)
 Dimensions:
 178 mm Width X 50 mm Height X 152 mm Depth

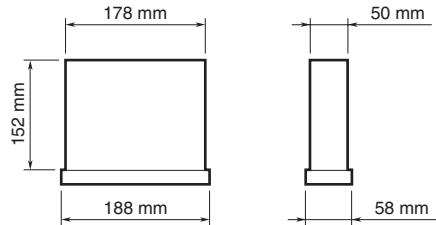

Notes:

- Specifications comply with JEITA Standards.
- Specifications and design are subject to change without notice for further improvement.
- Please make sure when connecting external power amplifier, that you properly, to the car chassis, ground the amplifier.
- If this is not done, severe damage to the source unit may happen.

Clarion Co., Ltd.

All Rights Reserved. Copyright © 2004: Clarion Co., Ltd.
Printed in Malaysia / Imprimé en Malaisie / Impreso en Malasia

PE-2739B
280-8151-00

Free Manuals Download Website

<http://myh66.com>

<http://usermanuals.us>

<http://www.somanuals.com>

<http://www.4manuals.cc>

<http://www.manual-lib.com>

<http://www.404manual.com>

<http://www.luxmanual.com>

<http://aubethermostatmanual.com>

Golf course search by state

<http://golfingnear.com>

Email search by domain

<http://emailbydomain.com>

Auto manuals search

<http://auto.somanuals.com>

TV manuals search

<http://tv.somanuals.com>