

Clarion®

Owner's manual

사용 설명서

DMZ637MP

2DIN AM/FM CD/MP3/WMA/MD PLAYER

2DIN AM/FM CD/MP3/WMA/MD 플레이어

CaNET

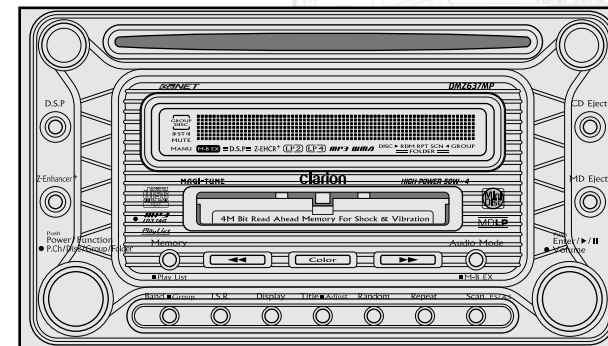

Clarion Co., Ltd.

All Rights Reserved. Copyright © 2003: Clarion Co., Ltd.

Printed in China

본 매뉴얼의 저작권은 Clarion Co. Ltd 에 있음, 2003
중국에서 인쇄

2003/5 (D/AB)

PE-4075K
280-7963-00



Thank you for purchasing this **Clarion** product.

- * Please read this owner's manual in its entirety before operating this equipment.
- * After reading this manual, be sure to keep it in a handy place (e.g., glove compartment).
- * Check the contents of the enclosed warranty card and keep it carefully with this manual.
- * This manual includes the operating procedures of the CD changer, MD changer and TV tuner connected via the CeNET cable. The CD changer, MD changer and TV tuner have their own manuals, but no explanations for operating them are described.

Contents

1. FEATURES	2
2. PRECAUTIONS	3
Handling Compact Discs	4
Handling MD	4
3. CONTROLS	5
Display Items	5
LCD Screen	5
4. NOMENCLATURE	6
Names of the Buttons and their Functions	6
Major button operations when external equipment is connected to this unit	7
5. REMOTE CONTROL	8
Inserting the Batteries	8
Functions of Remote Control Unit Buttons	9
6. OPERATIONS	10
Basic Operations	10
Radio Operations	13
CD/MP3/MD Operations	14
Operations Common to Each Mode	19
7. OPERATIONS OF ACCESSORIES	22
CD/MD Changer Operations	22
TV Operations	24
8. IN CASE OF DIFFICULTY	26
9. ERROR DISPLAYS	28
10. SPECIFICATIONS	30

1. FEATURES

- MP3 and WMA File Playable with ID3-TAG and Display
- MDLP Playable with Group Management Function
- 728-Variable Acryl Edge Light
- Read Ahead Memory for Shock Resistance for CD and MD
- MAGNA BASS EX for Dynamic Bass Tuning, Volume Level Dependent
- Screen Saver with User Programmable MESSAGE INFORMATION
- CeNET with Balanced Audio Line Transmission and Dynamic Noise Canceling
- CD-R/CD-RW Compatible

5. REMOTE CONTROL

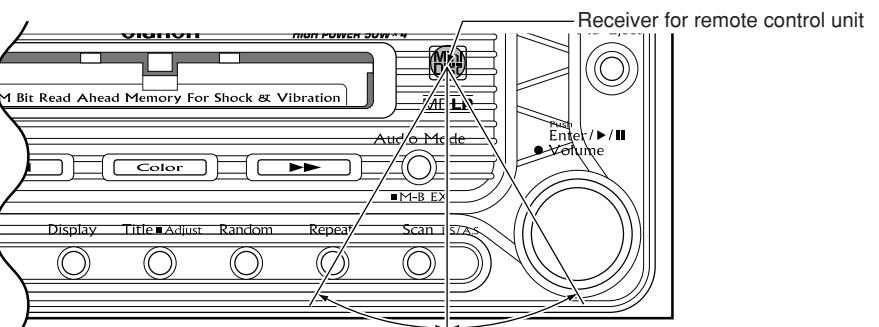

Remote control unit

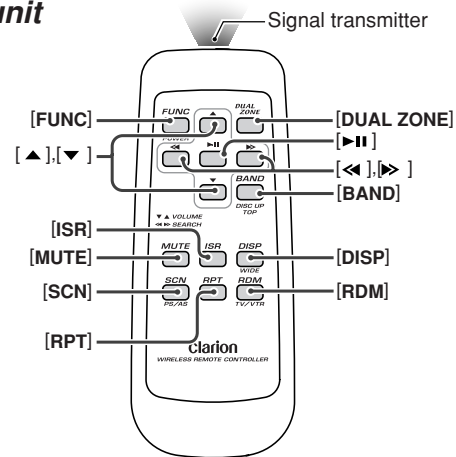

Inserting the Batteries

Turn the remote control unit over, then slide the rear cover in the direction of the arrow.

Insert the AA (SUM-3, IECR-6/1.5V) batteries that came with the remote control unit facing in the directions shown in the figure, then close the rear cover.

Notes:

Inserting batteries improperly can cause them to explode. Take note of the following points:

When replacing batteries, replace both batteries with new ones.

Do not short-circuit, disassemble or heat batteries.

Do not dispose of batteries into fire or flames.

Dispose of spent batteries properly.

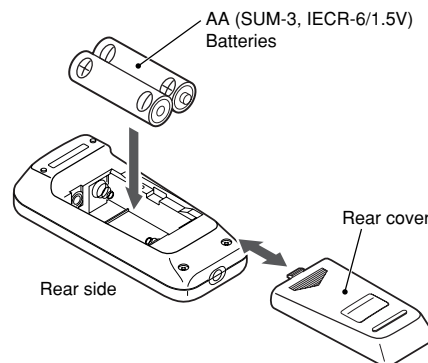

2. PRECAUTIONS

- When the inside of the car is very cold and the player is used soon after switching on the heater moisture may form on the disc or the optical parts of the player and proper playback may not be possible. If moisture forms on the disc, wipe it off with a soft cloth. If moisture forms on the optical parts of the player, do not use the player for about one hour. The condensation will disappear naturally allowing normal operation.
- Driving on extremely bumpy roads which cause severe vibration may cause the sound to skip.
- This unit uses a precision mechanism. Even in the event that trouble arises, never open the case, disassemble the unit, or lubricate the rotating parts.

CAUTION

USE OF CONTROLS, ADJUSTMENTS, OR PERFORMANCE OF PROCEDURES OTHER THAN THOSE SPECIFIED HEREIN, MAY RESULT IN HAZARDOUS RADIATION EXPOSURE.

THE COMPACT DISC PLAYER and MINI DISC PLAYER SHOULD NOT BE ADJUSTED OR REPAIRED BY ANYONE EXCEPT PROPERLY QUALIFIED SERVICE PERSONNEL.

CHANGES OR MODIFICATIONS NOT EXPRESSLY APPROVED BY THE MANUFACTURER FOR COMPLIANCE COULD VOID THE USER'S AUTHORITY TO OPERATE THE EQUIPMENT.

INFORMATION FOR USERS:

CHANGES OR MODIFICATIONS TO THIS PRODUCT NOT APPROVED BY THE MANUFACTURER WILL VOID THE WARRANTY.

English

Handling Compact Discs

Use only compact discs bearing the or mark.

Do not play heart-shaped, octagonal, or other specially shaped compact discs.

Some CDs recorded in CD-R/CD-RW mode may not be usable.

Handling

- Compared to ordinary music CDs, CD-R and CD-RW discs are both easily affected by high temperature and humidity and some of CD-R and CD-RW discs may not be played. Therefore, do not leave them for a long time in the car.
- New discs may have some roughness around the edges. If such discs are used, the player may not work or the sound may skip. Use a ball-point pen or the like to remove any roughness from the edge of the disc.
- Never stick labels on the surface of the compact disc or mark the surface with a pencil or pen.
- Never play a compact disc with any cellophane tape or other glue on it or with peeling off marks. If you try to play such a compact disc, you may not be able to get it back out of the CD player or it may damage the CD player.

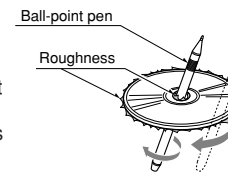

- Do not use compact discs that have large scratches, are misshapen, cracked, etc. Use of such discs may cause misoperation or damage.
- To remove a compact disc from its storage case, press down on the center of the case and lift the disc out, holding it carefully by the edges.
- Do not use commercially available CD protection sheets or discs equipped with stabilizers etc. These may damage the disc or cause breakdown of the internal mechanism.

Storage

- Do not expose compact discs to direct sunlight or any heat source.
- Do not expose compact discs to excess humidity or dust.
- Do not expose compact discs to direct heat from heaters.

Cleaning

- To remove fingermarks and dust, use a soft cloth and wipe in a straight line from the center of the compact disc to the circumference.
- Do not use any solvents, such as commercial cleaners, anti-static spray, or thinner to clean compact discs.
- After using special compact disc cleaner, let the compact disc dry off well before playing it.

Handling MD

Use only MDs bearing the mark.

Handling

- Never open the shutter on the MD cartridge.

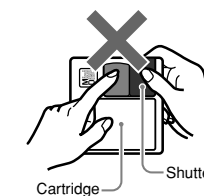

- Never play a minidisc with an index label that is peeling off.

If you try to play such a minidisc, you may not be able to get it back out of the MD player or it may damage the MD player.

Storage

- Do not expose minidisks to direct sunlight or any heat source.
- Do not expose minidisks to excess humidity or dust.
- Do not expose minidisks to direct heat from heaters.

Cleaning

- If the MD cartridge is dirty, wipe off the dirt with a soft dry cloth.
- Discs recorded in monaural mode cannot be played on this unit.

Be sure to unfold and read the next page.

이 페이지를 펼친 채로 다음 페이지를 읽어 주십시오.

3. CONTROLS / 컨트롤

Source unit / 본체

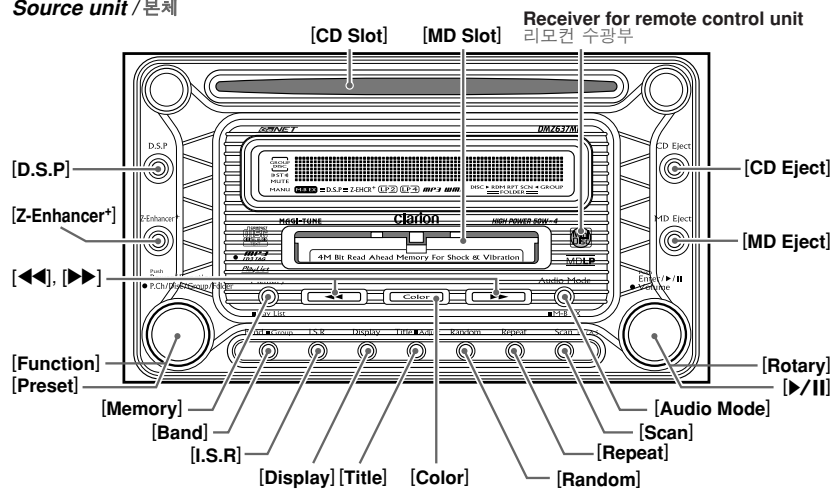

Note: Be sure to unfold this page and refer to the front diagrams as you read each chapter.

주: 이 페이지를 펼쳐두고, 각 장을 읽을 때 전면 그림을 참조하십시오.

Display Items/화면 표시 항목

<p>GROUP DISC : Group disc indication 그룹 디스크</p> <p>ST : Stereo indication 스테레오</p> <p>MUTE : Mute indication 음소거</p> <p>MANU : Manual indication 수동 모드</p>	<p>• Operation status indication : Main, titles, clock, etc. are displays. 작동 상태 : 메인 화면, 제목, 시계 등이 표시</p> <p>• Function mode indication : The names of modes being selected, etc. are displayed. 기능 모드 : 선택된 모드 등이 표시</p> <p>• Preset channel indication (1 to 6) / 프리셋 채널 (1 - 6)</p> <p>• Disc number indication (1 to 12) / 디스크 번호 (1 - 12)</p>
---	---

<p>M-B EX : MAGNA BASS EX indication MAGNA BASS EX</p> <p>D.S.P : DSP indication / DSP</p> <p>Z-EHCR+ : Z-Enhancer Plus indication Z-Enhancer Plus</p> <p>LP2 : LP2 indication / LP2</p> <p>LP4 : LP4 indication / LP4</p> <p>MP3 : MP3 indication / MP3</p> <p>WMA : WMA indication / WMA</p>	<p>GROUP : Group (Random, Repeat, Scan) indication 그룹 (랜덤, 반복, 스캔)</p> <p>DISC : Disc (Random, Repeat, Scan) indication 디스크 (랜덤, 반복, 스캔) 표시</p> <p>FOLDER : Folder (Random, Repeat, Scan) indication 폴더 (랜덤, 반복, 스캔) 표시</p> <p>RDM : Random indication / 랜덤</p> <p>RPT : Repeat indication / 반복</p> <p>SCN : Scan indication / 스캔</p> <p>GROUP : Group indication / 그룹</p>
---	---

CD Screen/LCD 스크린

extreme cold, the screen movement may slow down and the screen may darken, but this is normal. the screen will recover when it returns to normal temperature.

도가 지나치게 낮을 경우, 스크린에 나타나는 각종 움직임이 둔해지거나 화면이 어두워질 수 있는 고장은 아닙니다. 온도가 정상으로 회복되면 스크린의 움직임도 정상으로 돌아옵니다.

4. NOMENCLATURE

English

Note:

• Be sure to read this chapter referring to the front diagrams of chapter "3. CONTROLS" on page 5 (unfold).

Names of the Buttons and their Functions

[CD Slot]

- CD insertion slot.

[MD Slot]

- MD insertion slot.

[CD Eject] button

- Eject a CD when it is loaded into the unit.

[MD Eject] button

- Eject a MD when it is loaded into the unit.

[Rotary] knob

- Adjust the volume by turning the knob clockwise or counterclockwise.
- Use the knob to perform various settings.

[P/II] button

- Play or pause while in the CD/MD mode.

[Audio Mode] button

- Use the button to switch to the audio mode (bass/treble, balance/fader Z-Enhancer Plus)
- Press and hold for 1 second or longer to turn on or off the MAGNA BASS EX.

[Scan] button

- Perform scan play for 10 seconds of each track while in the CD/MD mode.
- Press and hold the button for 1 second or longer to perform folder (group) scan play in the MP3/MD disc.
- Perform preset scan while in the radio mode. When the button is pressed and held, auto store is performed.

[Repeat] button

- Perform repeat play while in the CD/MD mode.
- Press and hold the button for 1 second or longer to perform folder (group) repeat play in the MP3/MD disc.

[Random] button

- Perform random play while in the CD/MD mode.
- Press and hold the button for 1 second or longer to perform folder (group) random play in the MP3/MD disc.

[Color] button

- Button's color change to multicolor.
- Press and hold to enter the color adjustment mode while the User Color is on.

[Title] button

- Use the button to input a title in the Tuner, CD mode.
- Press and hold the button for 1 second or longer to enter the adjust mode.

[Display] button

- Switch the display indication (Main display, Title display, Clock display).
- When the button is pressed and held, switches the disc titles, group titles or track titles while in the MD mode.
- When the button is pressed and held, switches the user titles or track titles, etc. while in the CD mode.

[I.S.R] button

- Recall ISR radio station in memory.
- Press and hold for 2 seconds or longer: Store current station into ISR memory (radio mode only).

[Band] button

- Switch the band, or seek tuning or manual tuning while in the radio mode.
- Play a first track while in the CD/MD mode.
- Press and hold for 1 second or longer to turn on or off the group mode. when playing a group-edited MD

[Memory] button

- Press and hold for 1 second or longer to turn on or off the play list mode. (MP3/WMA disc only)
- Register a preset memory.

[Function] button

- Press the button to turn on the power. Press and hold the button for 1 second or longer to turn off the power.
- Switches the operation mode among the radio mode, etc.

[Preset] knob

- Preset a station to start with in the radio mode.
- Select the folder (group) in the MP3/MD disc.
- Select an item for various settings (in the adjust mode).

[<<], [>>] buttons

- Select a station while in the radio mode or select a track when listening to a CD/MD. These buttons are used to make various settings.
- Press and hold the button for 1 second or longer to switch the fast-forward/fast-backward.

[Z-Enhancer+] button

- Use the button to select one of the 3 types of sound characteristics already stored in memory.

[D.S.P] button

- Select the DSP mode.

Major button operations when external equipment is connected to this unit

● When the CD/MD/DVD changer is connected

- * For details, see the section "CD/MD changer operations". For the DVD changer, refer to the Owner's Manual provided with the DVD changer.

[P/II] button

- Play or pause a CD, MD or DVD.

[Scan] button

- Perform scan play for 10 seconds of each track. Disc scan play is performed when the button is pressed and held.

[Repeat] button

- Perform repeat play. Disc repeat play is performed when the button is pressed and held.

[Random] button

- Perform random play. Disc random play is performed when the button is pressed and held.

[Title] button

- Use the button to input a title in the CD changer mode.
- Use the button to scroll the title during CD-text play or MD changer play in the MD changer mode.

[Display] button

- When the button is pressed and held, switches the disc titles or track titles while in the MD changer mode.
- When the button is pressed and held, switches the user titles or track titles, etc. while in the CD changer mode.

[Band] button

- Move the next disc in increasing order.

[Preset] knob

- Select the disc.

[<<], [>>] buttons

- Select a track when listening to a disc.
- Press and hold the button for 1 second or longer to switch the fast-forward/fast-backward.

● When the TV is connected

- * For details, see the section "TV operations"

[Scan] button

- Perform preset scan while in the TV mode. When the button is pressed and held, auto store is performed.

[Repeat] button

- Switches between ST and MONO. When pressed and held for 1 second: Switches between MAIN and SUB.

[Random] button

- Switch the TV picture mode or VTR (external picture mode).

[Band] button

- Switch the band.
- When the button is pressed and held, switch seek tuning or manual mode.

[Preset] knob

- Preset a station to start with in the TV mode

[<<], [>>] buttons

- Select a station.

Functions of Remote Control Unit Buttons

Mode Button	Radio	CD/MP3/MD	CD/MD changer DVD changer	TV
[FUNC]	Press the button to turn on the power. Press and hold the button for 1 second or longer to turn off the power. Switches among radio, CD/MP3, MD, CD/MD changer, DVD changer, TV and AUX.			
[BAND]	Switches reception band.	Plays the first track. Top play.	Moves the next disc in increasing order.	Switches reception band.
[▲], [▼]	Increases and decreases volume (in all modes).			
[◀], [▶]	Moves preset channels up and down.	Moves tracks up and down. When pressed and held for 1 second: Fast-forward/fast-backward.		Moves preset channels up and down.
[⏸]	No function.	Switches between playback and pause.		No function.
[MUTE]	Turns mute on and off.			
[ISR]	Recalls ISR radio station in memory. Press and hold for 2 seconds or longer: Stores current station into ISR memory (radio mode only).			
[DISP]	Switches among main display, title display, clock display. Press and hold for 1 second or longer: Switches some titles.			
[SCN]	Preset scan. When pressed and held for 2 seconds: Auto store.	Scan play. Press and hold the button for 1 second or longer to perform folder (group) scan play in the MP3/MD disc.	Scan play. When pressed and held for 1 second: Disc scan play.	Preset scan. When pressed and held for 2 seconds: Auto store.
[RPT]	No function.	Repeat play. Press and hold the button for 1 second or longer to perform folder (group) Repeat play in the MP3/MD disc.	Repeat play. When pressed and held for 1 second: Disc repeat play.	Switches between ST and MONO. When pressed and held for 1 second: Switches between MAIN and SUB.
[RDM]	No function.	Random play. Press and hold the button for 1 second or longer to perform folder (group) Random play in the MP3/MD disc.	Random play. When pressed and held for 1 second: Disc random play.	Switches between TV and VTR.

* Some of the corresponding buttons on the main unit and remote control unit have different functions.

* [DUAL ZONE] button is not available

6. OPERATIONS

Basic Operations

Note: Be sure to read this chapter referring to the front diagrams of chapter "3. CONTROLS" on page 5 (unfold).

CAUTION

Be sure to lower the volume before switching off the unit power or the ignition key. The unit remembers its last volume setting. If you switch the power off with the volume up, when you switch the power back on, the sudden loud volume may hurt your hearing and damage the unit.

Turning on/off the power

Note:

• Be careful about using this unit for a long time without running the engine. If you drain the car's battery too far, you may not be able to start the engine and this can reduce the service life of the battery.

1. Press the [Function] button.
2. The illumination and display on the unit light up. The unit automatically remembers its last operation mode and will automatically switch to display that mode.
3. Press and hold the [Function] button for 1 second or longer to turn off the power for the unit.

Note:

System check

The first time this unit is turned on after the wire connections are completed, it must be checked what equipment is connected. When the power is turned on, "SYSTEM CHECK" and "Push POWER" appear in the display alternately, so press the [Function] button. The system check starts within the unit. When the system check is complete, press the [Function] button again.

Selecting a mode

1. Press the [Function] button to change the operation mode.
2. Each time you press the [Function] button, the operation mode changes in the following order:

Radio mode → CD/MP3 mode → MD mode → CD changer mode → MD changer mode → DVD changer mode → TV mode → AUX mode → Radio mode...

* External equipment not connected with CeNET is not displayed.

Adjusting the volume

Turning the [Rotary] knob clockwise increases the volume; turning it counterclockwise decreases the volume.

* The volume level is from 0 (minimum) to 33 (maximum).

Switching the display

Press the [Display] button to select the desired display.

Each time you press the [Display] button, the display switches in the following order:

Main display

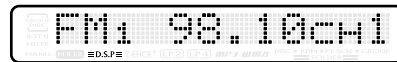

Title display

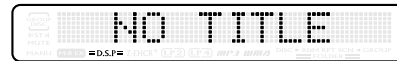

Clock display

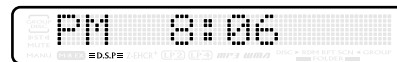

Main display

* Once selected, the preferred display becomes the display default. When a function adjustment such as volume is made, the screen will momentarily switch to that function's display, then revert back to the preferred display several seconds after the adjustment.

* When you have entered a title in a CD, it appears in the main display. If you have not entered a title, "NO TITLE" appears in the title display instead. For information on how to enter a title, refer to the subsection "Entering titles" in section "Operations Common to Each Mode".

Selecting a DSP menu

The DSP (digital sound processor) function is a function that enables the simulation of sound effects produced by digital signal process in the car, without deteriorating the sound quality.

* The factory default setting is "STADIUM".

Each time you press the [D.S.P] button, the tone effect changes in the following order:

"STADIUM" → "HALL" → "CLUB" → "CHURCH" → "L-ROOM" → "DSP OFF" → "STADIUM" ...

- STADIUM : A sound field with a wide ceiling such as a stadium
- HALL : A sound field such as a large hall
- CLUB : A sound field such as a small-sized disco hall
- CHURCH : A sound field with a tall ceiling such as a cathedral
- L-ROOM : A sound field such as a listening room
- DSP OFF : no sound effect

Setting the Z-Enhancer Plus

This unit are provided with 3 types of sound tone effects stored in memory. Select the one you prefer.

* The factory default setting is "Z-EHCR+ OFF".

Each time you press the [Z-Enhancer+] button, the tone effect changes in the following order:

"Z-EHCR+ OFF" → "BASS BOOST" → "IMPACT" → "EXCITE" → "USER CUSTOM" → "Z-EHCR+ OFF" ...

- BASS BOOST : bass emphasized
- IMPACT : bass and treble emphasized
- EXCITE : bass and treble emphasized mid de-emphasized
- USER CUSTOM : user custom
- Z-EHCR+ OFF : no sound effect

Adjusting the Effect

Effect means a reflecting sound that rebounds against the walls, etc. The volume of the reflected sound can be changed on this unit (When DSP function is "on").

1. Press the [Audio Mode] button and select the Effect to adjust.
2. Turning the [Rotary] knob for adjustment.
 - * Adjustment range 0% to 70%

Adjusting the tone

Press the [Audio Mode] button and select the item to adjust. Each time you press the [Audio Mode] button, the item changes as following order:

● When "BASS BOOST" is set

"EFFECT" → "B-BOOST" → "BALANCE" → "FADER" → Last function mode.

● When "IMPACT" is set

"EFFECT" → "IMPACT" → "BALANCE" → "FADER" → Last function mode.

● When "EXCITE" is set

"EFFECT" → "EXCITE" → "BALANCE" → "FADER" → Last function mode.

● When "USER CUSTOM" is set

"EFFECT" → "BASS" → "TREBLE" → "BALANCE" → "FADER" → Last function mode.

● When "Z-EHCR+ OFF" is set

"EFFECT" → "BALANCE" → "FADER" → Last function mode.

Adjusting the Z-Enhancer Plus

1. Press the [Z-Enhancer+] button and select the Z-Enhancer Plus mode to adjust.
2. Press the [Audio Mode] button and select the Z-Enhancer Plus mode to adjust.
3. Turning the [Rotary] knob for adjustment.
 - When "B-BOOST 0" selected, you can adjust the bass in the range of -3 to 3.
 - When "IMPACT 0" selected, you can adjust the bass and treble in the range of -3 to 3.
 - When "EXCITE 0" selected, you can adjust the bass and treble in the range of -3 to 3.

Adjusting the bass (Gain, Frequency, Q-curve)

This adjustment can be performed when the Z-Enhancer Plus is set to "USER CUSTOM".

1. Press the [Audio Mode] button and select "BASS".
2. Turning the [Rotary] knob clockwise emphasizes the bass; turning it counterclockwise attenuates the bass.
 - * The factory default setting is "BASS◀G 0▶". (Adjustment range: -6 to +6)
3. Press the [◀◀] or [▶▶] button to select "BASS◀FREQ▶".

Turning the [Rotary] knob clockwise or counterclockwise to select the frequency.

Basic Operations

- * The factory default setting is "BASS◀F 60▶". (Adjustment 60/100/200 Hz)
4. Press the [◀◀] or [▶▶] button to select "BASS◀Q▶".
Turning the [Rotary] knob clockwise or counterclockwise to select the Q-curve.
* The factory default setting is "BASS◀Q 1▶". (Adjustment 1/1.25/1.5/2)
 5. When the adjustment is complete, press the [Audio Mode] button several times until the function mode is reached.

Adjusting the treble (Gain, Frequency)

This adjustment can be performed when the Z-Enhancer Plus is set to "USER CUSTOM".

1. Press the [Audio Mode] button and select "TREBLE".
2. Turning the [Rotary] knob clockwise emphasizes the treble; turning it counterclockwise attenuates the treble.
* The factory default setting is "TREB◀G 0▶". (Adjustment range: -6 to +6)
3. Press the [◀◀] or [▶▶] button to select "TREB◀FREQ▶".
Turning the [Rotary] knob clockwise or counterclockwise to select the frequency.
* The factory default setting is "TREB◀F 10K▶". (Adjustment 10 kHz/15 kHz)
4. When the adjustment is complete, press the [Audio Mode] button several times until the function mode is reached.
* Press and hold the [Z-enhancer+] button for 1 second or longer, then the setting parameter of bass/treble will be initialized with a display "Z-EHCR+FLAT".

Adjusting the balance

1. Press the [Audio Mode] button and select "BALANCE".
2. Turning the [Rotary] knob clockwise emphasizes the sound from the right speaker; turning it counterclockwise emphasizes the sound from the left speaker.
* The factory default setting is "BALANCE 0". (Adjustment range: L13 to R13)
3. When the adjustment is complete, press the [Audio Mode] button several times until the function mode is reached.

Adjusting the fader

1. Press the [Audio Mode] button and select "FADER".
2. Turning the [Rotary] knob clockwise emphasizes the sound from the front speakers; turning it counterclockwise emphasizes the sound from the rear speakers.
* The factory default setting is "FADER 0". (Adjustment range: F12 to R12)
3. When the adjustment is complete, press the [Audio Mode] button several times until the function mode is reached.

Adjusting MAGNA BASS EX

The MAGNA BASS EX does not adjust the low sound area like the normal sound adjustment function, but emphasizes the deep bass sound area to provide you with a dynamic sound.

* The factory default setting is off.

1. Press and hold the [Audio Mode] button for 1 second or longer to turn on the MAGNA BASS EX effect. "M-B EX" lights in the display.
2. Press and hold the [Audio Mode] button for 1 second or longer to turn off the MAGNA BASS EX effect. "M-B EX" goes off from the display.

Radio Operations

FM reception

For enhanced FM performance the **MAGI-TUNE3**® tuner includes signal actuated stereo control, Enhanced Multi AGC, Impulse noise reduction circuits and Multipath noise reduction circuits.

Listening to the radio

1. Press the [Function] button and select the radio mode. The frequency in the display.
2. Press the [Band] button and select the radio band. Each time the button is pressed, the radio reception band changes in the following order:
FM1 → FM2 → FM3 → AM → FM1...
3. Press the [◀◀] or [▶▶] button to tune in the desired station.

Tuning

There are 3 types of tuning mode available, seek tuning, manual tuning and preset tuning.

Seek tuning

1. Press the [Band] button and select the desired band (FM or AM).
* If "MANU" is lit in the display, press and hold the [Band] button for 1 second or longer. "MANU" in the display goes off and seek tuning is now available.
2. Press the [◀◀] or [▶▶] button to automatically seek a station.
When the [▶▶] button is pressed, the station is sought in the direction of higher frequencies; if the [◀◀] button is pressed, the station is sought in the direction of lower frequencies.

Manual tuning

There are 2 ways available: Quick tuning and step tuning.

When you are in the step tuning mode, the frequency changes one step at a time. In the quick tuning mode, you can quickly tune the desired frequency.

1. Press the [Band] button and select the desired band (FM or AM).
* If "MANU" is not lit in the display, press and hold the [Band] button for 1 second or longer. "MANU" is lit in the display and manual tuning is now available.
2. Tune into a station.

● Quick tuning:

Press and hold the [◀◀] or [▶▶] button for 1 second or longer to tune in a station.

● Step tuning:

Press the [◀◀] or [▶▶] button to manually tune in a station.

Preset tuning

A total of 24 preset positions (6-FM1, 6-FM2, 6-FM3, 6-AM) exists to store individual radio stations in memory.

1. Press the [Band] button and select the desired band (FM or AM).
2. Turning the [Preset] knob to select a station to start with.

Manual memory

1. Press the [Band] button and select the desired band (FM or AM).
2. Press [◀◀] or [▶▶] button to select a station to be put into memory. Then, press the [Memory] button.
3. Turning the [Preset] knob to select a preset memory number to be registered.
4. Press and hold the [Memory] button (for about 2 seconds).
* After a registration is completed, "CH" indication becomes lit in the display from the blinking status.

Auto store

Auto store is a function for storing up to 6 stations that are automatically tuned in sequentially. If 6 receivable stations cannot be received, a previously stored station remains unoverwritten at the memory position.

1. Press the [Band] button and select the desired band (FM or AM).
2. Press and hold the [Scan] button for 2 seconds or longer. The stations with good reception are stored automatically to the preset channels.

Preset scan

Preset scan receives the stations stored in preset memory in order. This function is useful when searching for a desired station in memory.

1. Press the [**Scan**] button.
2. When a desired station is tuned in, press the [**Scan**] button again to continue receiving that station.

Note:

- Be careful not to press and hold the [**Scan**] button for 2 seconds or longer, otherwise the auto store function is engaged and the unit starts storing stations.

Instant station recall (ISR)

Instant station recall is a special radio preset that instantly accesses a favorite radio station at a touch of a button. The ISR function even operates with the unit in other modes.

●ISR memory

1. Select the station that you wish to store in ISR memory.
2. Press and hold the [**I.S.R**] button for 2 seconds or longer.

●Recalling a station with ISR

In any mode, press the [**I.S.R**] button to turn on the radio function and tune the selected radio station. "ISR" appears in the display. Press the [**I.S.R**] button again to return to the previous mode.

MP3/WMA**What is MP3?**

MP3 is an audio compression method and classified into audio layer 3 of MPEG standards. This audio compression method has penetrated into PC users and become a standard format.

This MP3 features the original audio data compression to about 10 percent of its initial size with a high sound quality. This means that about 10 music CDs can be recorded on a CD-R disc or CD-RW disc to allow a long listening time without having to change CDs.

What is WMA?

WMA is the abbreviation of Windows Media Audio, an audio file format developed by Microsoft Corporation.

Notes:

- If you play a file with DRM (Digital Rights Management) for WMA remaining ON, no audio is output.
- Windows Media™, and the Windows ® logo are trademarks, or registered trademarks of Microsoft Corporation in the United States and/or other countries.

●To disable DRM (Digital Rights Management):

1. When using Windows Media Player 7, click on TOOLS → OPTIONS → CD AUDIO; there, uncheck the ENABLE PERSONAL RIGHTS MANAGEMENT check box, then construct files.
2. When using Windows Media Player for Windows XP 8, click on TOOLS → OPTIONS → COPY MUSIC tab, then under COPY SETTINGS, unclick the check box for PROTECT CONTENT. Thereafter, reconstruct files.
Personally constructed WMA files are used at your own responsibility.

Precautions when creating MP3/WMA disc**● Usable sampling rates and bit rates:**

1. MP3: Sampling rate 8k Hz-48 kHz,
Bit rate: 8 kbps-320 kbps / VBR
2. WMA: Bit rate 48 kbps-192 kbps

● File extensions

1. Always add a file extension ".MP3" or ".WMA" to MP3 or WMA file by using single byte letters. If you add a file extension other than specified or forget to add the file extension, the file cannot be played.

2. Files without MP3/WMA data will not play. The indication "—:—" appears in the play time display if you attempt to play files without MP3/WMA data.

● Logical format (File system)

1. When writing MP3/WMA file on a CD-R disc or CD-RW disc, please select "ISO9660 level 1, 2, 3 or JOLIET or Romeo" as the writing software format. Normal play may not be possible if the disc is recorded on another format.
2. The folder name and file name can be displayed as the title during MP3/WMA play but the title must be within 128 single byte alphabetical letters and numerals (including an extension).
3. Do not affix a name to a file inside a folder having the same name.

● Folder structure

1. A disc with a folder having more than 8 hierarchical levels will be impossible.

● Number of files or folders

1. Up to 255 files can be recognized per folder. Up to 500 files can be played.
2. Tracks are played in the order that they were recorded onto a disc. (Tracks might not always be played in the order displayed on the PC.)
3. Some noise may occur depending on the type of encoder software used while recording.

Multisession function

When a disc contains both normal CD type tracks and MP3/WMA type tracks mixedly, you can select which type of the recorded tracks to play.

● Default value is "CD".

Each time you press and hold the [**Band**] button for about 1 second, the mixed mode is switched between CD type or MP3/WMA type. The following indication appears in the title display when switching the track type to be played.

● Display when CD type track is selected:

M-SESS CD

● Display when MP3/WMA type track is selected:

M-SESS MP3

1. Types of recording that can be played are as follows.

Disc	Setting	Set to CD	Set to MP3/WMA
Mixed with CD and MP3/WMA type tracks		Play CD	Play MP3/WMA
CD type track only		Play CD	Play CD
MP3/WMA type track only		Play MP3/WMA	Play MP3/WMA

2. After making these settings, remove the disc and then reinsert it.
3. When a mixed mode CD is loaded and CD is set, the track to be played first is MP3/WMA file data and no sound is heard.

Play list mode

This function allows you to play tracks, up to latest 5 time stamps, by reading the play list information written on the disc.

1. Press and hold the [**Memory**] button for 1 second or longer to turn on or off the play list mode.
2. Turning the [**Preset**] knob.
3. Press the [◀◀] or [▶▶] buttons to change the track.

Notes:

- Play list play is possible only when there is a file whose extension is ".M3U" or ".ASX" on the CDR-RW.
- Up to 5 play lists can be recognized, and up to 255 files can be recognized per play list.
- The SCN/RPT/RDM functions cannot be used while in the play list mode.
- The title display changes from folder name to play list name.

Making a play list

1. Write desired tracks to a CD-R/RW, etc. Be sure to use alphanumeric/ASCII characters for all file names.
2. Make a play list by using a multimedia player, etc. and save the data. The file format must be M3U or ASX.
3. Again, write this play list to the CD-R/RW, etc.

Notes:

- When writing to a CD-R/RW, etc., be sure to use alphanumeric/ASCII characters.
- Up to 5 layers can be recognized as a list. For written play lists, latest 5 lists are recognized in the order in which they are written.
- When writing to a CD-R/RW, etc., turn off the Disc At Once function.
- When adding a play list, it is recommended to write it in the "Root" folder.

Turning the Group Function on/off

When playing a group-edited MD with the Group Function turned on, group play is possible.

1. Insert a group-edited MD.
 - *  is lit in the display.
2. Press and hold the **[Band]** button (for about 1 second).

Note:

- If a regular MD is played, it is not possible to turn the Group Function on/off.
- When the Group Function is turned off, the MD is played in the order of track number.

Disc-In-Play function

As long as the ignition key is turned to the ON or ACC position, this function allows you to turn the power to the unit and start playing the disc automatically when the disc is inserted even if the power is not turned on.

CAUTION

- Do not try to put your hand or fingers in the disc insertion slot. Also never insert foreign objects into the slot.
- Do not insert discs where adhesive comes out from cellophane tape or a rental CD label, or discs with marks where cellophane tape or rental CD labels were removed. It may be impossible to extract these discs from the unit and they may cause the unit to break down.

Listening to a disc already loaded in the unit



1. Press the **[Function]** button to select the CD/MP3 or MD mode.

When the unit enters the CD/MP3 or MD mode, play starts automatically. If there is no disc loaded, the indication "NO DISC" appears in the title display.

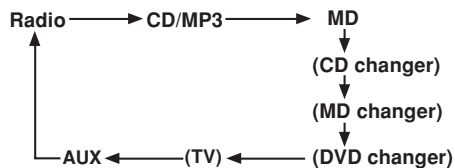
 - * The mode changes each time the **[Function]** button is pressed. (Modes are not displayed for equipment that is not connected.)



Notes:

- Never insert foreign objects into the CD/MD SLOT.
- If the CD/MD are not inserted easily, there may be another CD/MD in the mechanism or the unit may require service.
- Discs not bearing the  or  mark and CD-ROMs cannot be played by this unit.
- An MD that does not carry the  mark cannot be used with this unit.
- Some CDs recorded in CD-R/CD-RW mode may not be usable.

Loading 8 cm compact discs

- * No adapter is required to play an 8 cm CD.
- * Insert the 8 cm CD into the center of the insertion slot.

Backup Eject function

Just pressing the **[CD/MD Eject]** button ejects the disc even if the power to the unit was not turned on.

1. Press the **[CD/MD Eject]** button. Remove the disc after it is ejected.

Notes:

- The unit changes to the tuner mode about four seconds after the disc is ejected.

Pausing play

1. Press the **[▶/||]** button to pause play. "PAUSE" appears in the display.
2. To resume CD/MD play, press the **[▶/||]** button again.

Displaying CD/MD titles

This unit can display title data for CD-text/MP3/WMA disc and user titles input with this unit.

1. Press the **[Display]** button to display the title.
2. Each time you press and hold the **[Display]** button for 1 second or longer, the title display changes in the following order:

● CD-TEXT disc

User title (disc) → CD-text title (disc) → Artist name → CD-text title (track) → User title (disc)...

● MP3/WMA disc

Folder → File → Album TAG → Artist TAG → Title TAG → Folder...

● MD disc

Disc title → Group title → Track title → Disc title...

Notes:

- If the CD playing is not a CD-text CD or no user title has been input, "NO TITLE" appears in the display.
- If MP3/WMA disc is not input TAG, "NO TAG" appears in the display.
- For MP3, supports ID3 Tags V2.3 / 2.2 / 1.1 / 1.0.
- Tag displays give priority to V2.3 / 2.2.
- In the case of album Tags for WMA, the information written into the extension header is displayed.
- Only ASCII characters can be displayed in Tags.

Selecting a track

● Track-up

1. Press the **[▶▶]** button to move ahead to the beginning of the next track.
2. Each time you press the **[▶▶]** button, the track advances ahead to the beginning of the next track.

● Track-down

1. Press the **[◀◀]** button to move back to the beginning of the current track.
2. Press the **[◀◀]** button twice to move to the beginning of the previous track.

Fast-forward/fast-backward

● Fast-forward

Press and hold the **[▶▶]** button for 1 second or longer.

● Fast-backward

Press and hold the **[◀◀]** button for 1 second or longer.

* For MP3/WMA discs, it takes some time until the start of searching and between tracks. In addition, the playing time may have a margin of error.

Folder (Group) Select

● Folder Select

This function allows you to select a folder containing MP3/WMA files and start playing from the first track in the folder.

● Group Select

This function allows to select the group and start playing from the first track within the group when a group-edited MD is played. (When Group Function is on).

1. Turning the **[Preset]** knob.
2. Press the **[◀◀]** or **[▶▶]** buttons to change the track.

Top function

The top function resets the CD/MD player to the first track of the disc. Press the **[Band]** button to play the first track (track No. 1) on the disc.

* In case of MP3/WMA, the first track of a folder being played will be returned.

Scan play

This function allows you to locate and play the first 10 seconds of all the tracks recorded on a disc.

1. Press the **[Scan]** button to perform scan play.

The indication "SCN" lights up in the display, and "TRACK SCAN" (or "P-SCAN" when searching for a track in the MP3/WMA file) appears in the title display for about 2 seconds, then scan play starts.

 - * Scan play starts from the next track after the track currently being played.
2. To cancel scan play, press the **[Scan]** button again.

The play status indication such as "SCN" disappears from the display and the current track is played.

Folder (Group) scan play

This function allows you to locate and play the first 10 seconds of the first track of all the folders (group) on an MP3/WMA/MD disc.

1. Press and hold the **[Scan]** button for about 1 second to folder (group) scan play.

The indications "FOLDER (◀GROUP)" and "SCN" light up in the display and "FOLDER (GROUP SCAN)" appears for about 2 seconds in the title display, and then folder (group) scan play starts.
2. To cancel folder scan play, press the **[Scan]** button again.

The play status indications such as "FOLDER (◀GROUP)" and "SCN" disappear from the display and the current track is played.

Repeat play

This function allows you to play the current track repeatedly.

1. Press the **[Repeat]** button to perform repeat play.
The indication "**RPT**" lights up in the display and "**TRACK REPEAT**" (or "**R-REPEAT**" when performing repeated play for a track in the MP3/WMA file) appears for about 2 seconds in the title display, and then repeat play starts.
2. To cancel repeat play, press the **[Repeat]** button again.
The play status display such as "**RPT**" disappears from the display and normal play resumes from the track currently being played.

Folder (Group) repeat play

This function allows you to play a track currently being played in the MP3/WMA/MD folder (group) repeatedly.

1. Press and hold the **[Repeat]** button for about 1 second to perform folder (group) repeat play.
The indications "**FOLDER (◀GROUP)**" and "**RPT**" light up in the display and "**REPEAT (GROUP REPEAT)**" appears for about 2 seconds in the title display, and then folder (group) repeat play starts.
2. To cancel folder repeat play, press the **[Repeat]** button again.
The play status indications such as "**FOLDER (◀GROUP)**" and "**RPT**" disappear from the display and normal play resumes from the track currently being played.

Random play

This function allows you to play all tracks recorded on a disc in a random order.

1. Press the **[Random]** button to perform random play.
The indication "**RDM**" lights up in the display and "**TRACK RANDOM**" (or "**R-RANDOM**" when performing random play for tracks on a MP3/WMA disc) appears in the title display for about 2 seconds, and then random play starts. The tracks on the disc are then played in a random order.
2. To cancel random play, press the **[Random]** button again.
The play status indication such as "**RDM**" disappears from the display and normal play resumes from the track currently being played.

Folder (Group) random play

This function allows you to play all the tracks of all the folders (group) recorded on an MP3/WMA/MD disc in a random order.

1. Press and hold the **[Random]** button for about 1 second to perform folder (group) random play.
The indications "**FOLDER (◀GROUP)**" and "**RDM**" light up in the display and "**RANDOM (GROUP RANDOM)**" appear in the title display for about 2 seconds, and then folder (group) random play starts.
2. To cancel folder random play, press the **[Random]** button again.
The play status indications such as "**FOLDER (◀GROUP)**" and "**RDM**" disappear from the display and normal play resumes from the track currently being played.

Turning the screen saver function on or off

This unit is provided with the screen saver function which allows you to show various kinds of patterns and characters in the Operation Status indication area of the display in a random order. You can turn on and off this function.

If the button operation is performed with the screen saver function on, the operation display corresponding to the button operation is shown for about 30 seconds and the display returns to the screen saver display.

* The factory default setting is "**ON**".

1. Press and hold the **[Title]** button for 1 second or longer to switch to the adjustment selection display.
2. Press the **[◀◀]** or **[▶▶]** button to select "**SCRN SVR**".
3. Press the **[▶/II]** button.
4. Turning the **[Rotary]** knob clockwise or counterclockwise to select the setting. Each time you turn the **[Rotary]** knob, the setting changes in the following order:
OFF → ON → MESSAGE
5. Press the **[▶/II]** button to store the setting.
6. Press the **[Title]** button to return to the previous mode.

Entering MESSAGE INFORMATION

When the use of the message is selected for the screen saver setting, you can change the contents of the message.

* Up to 30 characters can be entered.

* The factory default setting is "**Welcome to Clarion**".

1. Press and hold the **[Title]** button for 1 second or longer to switch to the adjustment selection display.
2. Press the **[◀◀]** or **[▶▶]** button to select "**MSG INPUT**".
3. Press the **[▶/II]** button.
4. Press the **[◀◀]** or **[▶▶]** button to move the cursor.
5. Press the **[Display]** button to select a character. Each time you press the **[Display]** button, the character changes in the following orders:
Capital letters → Small letters → Numbers and Symbols → Capital letters...
6. Turning the **[Rotary]** knob to select the desired character.

7. Repeat step 4 to 6 to enter up to 30 characters for message.
8. Press and hold the **[▶/II]** button for 2 seconds or longer to store the message in memory and cancel input message.
9. Press the **[Title]** button to return to the previous mode.

Message display

When the unit is powered on or off, a message is displayed. The user can turn this message display ON or OFF.

* The factory default setting is "**ON**".

1. Press and hold the **[Title]** button for 1 second or longer to switch to the adjustment selection display.
2. Press the **[◀◀]** or **[▶▶]** button to select "**MESSAGE**".
3. Turning the **[Rotary]** knob clockwise to "**ON**" or counterclockwise to "**OFF**".
4. Press the **[Title]** button to return to the previous mode.

Setting the method for title scroll

Set how to scroll in CD-TEXT, MP3/WMA Title or MD.

* The factory default setting is "**ON**".

1. Press and hold the **[Title]** button for 1 second or longer to switch to the adjustment selection display.
2. Press the **[◀◀]** or **[▶▶]** button to select "**AUTO SCROLL**".
3. Turning the **[Rotary]** knob clockwise to "**ON**" or counterclockwise to "**OFF**".
● **ON:**
To scroll automatically.
● **OFF:**
To scroll just 1 time when the title was changed or the title key was pressed.
4. Press the **[Title]** button to return to the previous mode.

Dimmer control

You can setting the dimmer control on or off.

* The factory default setting is "**HIGH**".

1. Press and hold the **[Title]** button for 1 second or longer to switch to the adjustment selection display.
2. Press the **[◀◀]** or **[▶▶]** button to select "**DIMMER**".

Operations Common to Each Mode

- Turning the [Rotary] knob clockwise or counterclockwise to select the setting. Each time you turn the [Rotary] knob, the setting changes in the following order:
HIGH → MID → LOW
- Press the [Title] button to return to the previous mode.

Adjusting the display contrast

You can adjust the display contrast to match the angle of installation of the unit.

* The factory default setting is "8". (Adjustment level:1 to 16)

- Press and hold the [Title] button for 1 second or longer to switch to the adjustment selection display.
- Press the [◀◀] or [▶▶] button to select "CONTRAST".
- Turning the [Rotary] knob clockwise or counterclockwise to adjust the contrast.
- Press the [Title] button to return to the previous mode.

Setting the panel illumination

If the car illumination is lit while the ACC or the power is turned off, the panel illumination can be lit or unlit.

* The factory default setting is "ON".

- Press and hold the [Title] button for 1 second or longer to switch to the adjustment selection display.
- Press the [◀◀] or [▶▶] button to select "ILLUMINATION".
- Turning the [Rotary] knob clockwise to "ON" or counterclockwise to "OFF".
- Press the [Title] button to return to the previous mode.

Setting the beep sound

The pip sound on each operation is called beep sound. The beep sound function can be turned off on this unit.

* The factory default setting is "ON".

- Press and hold the [Title] button for 1 second or longer to switch to the adjustment selection display.
- Press the [◀◀] or [▶▶] button to select "BEEP".
- Turning the [Rotary] knob clockwise to "ON" or counterclockwise to "OFF".
- Press the [Title] button to return to the previous mode.

Selecting AUX IN sensitivity

Make the following settings to select the sensitivity when sounds from external devices connected to this unit are difficult to hear even after adjusting the volume.

* The factory default setting is "MID".

- Press and hold the [Title] button for 1 second or longer to switch to the adjustment selection display.
- Press the [◀◀] or [▶▶] button to select "AUX SENS".
- Turning the [Rotary] knob clockwise or counterclockwise to select the setting. Each time you turn the [Rotary] knob, the setting changes in the following order:
HIGH → MID → LOW
- Press the [Title] button to return to the previous mode.

Setting the clock

- Press and hold the [Title] button for 1 second or longer to switch to the adjustment selection display.
- Press the [◀◀] or [▶▶] button to select "CLOCK".
- Press the [▶/II] button.
- Press the [◀◀] or [▶▶] button to select the hour or the minute.
- Turning the [Rotary] knob clockwise or counterclockwise to set the correct time.
* The clock is displayed in 12-hour format.
- Press the [▶/II] button to store the time into memory.
- Press the [Title] button to return to the previous mode.

Note:

• You cannot set the clock when it is displayed with only the ignition on. If you drain or remove the car's battery or take out this unit, the clock is reset. While setting the clock, if another button or operation is selected, the clock set mode is canceled.

Setting the button illumination

Press the [Color] button to select a color type. Each time you press the [Color] button, the type changes in the following order:

COLOR SCAN → Indigo Blue → Surf Blue → Silky White → Aqua Green → Fresh Green → Leaf Green → Moon Yellow → Warm Amber → Pale Orange → Passion Red → Vivid Pink → Dark Violet → USER COLOR 1 → USER COLOR 2 → USER COLOR 3 → COLOR SCAN...

● Setting COLOR SCAN mode

As selecting "COLOR SCAN", the color automatically changes.

* The factory default setting is "COLOR SCAN".

* After 3 second the color changes to the other.

● Setting USER mode

The factory default setting is "R>8 G>8 B>8".

As selecting "USER COLOR", press and hold the [Color] button 1 second or longer "R>8 G>8 B>8" appears in the display.

- Press the [◀◀] or [▶▶] button to move the cursor.
- Turning the [Rotary] knob clockwise or counterclockwise to select from 0 to 8.
- Press and hold the [▶/II] button for 2 seconds or longer to store the color in memory and cancel setting mode.

COLOR	R	G	B
Indigo Blue	0	0	8
Surf Blue	0	4	8
Silky White	8	8	6
Aqua Green	0	8	1
Fresh Green	1	8	0
Leaf Green	6	8	0
Moon Yellow	8	5	0
Warm Amber	8	2	0
Pale Orange	8	1	0
Passion Red	8	0	0
Vivid Pink	8	0	3
Dark Violet	8	0	6
USER COLOR 1	8	8	8
USER COLOR 2	8	8	8
USER COLOR 3	8	8	8

Entering titles

Titles up to 10 characters long can be stored in memory and displayed for CD, CD changer and TV stations. The number of titles that can be entered for each mode are as follows.

Mode	Number of titles
CD mode	50 titles
TV mode	20 titles
Tuner mode	30 titles

CD changer mode	Number of titles
DCZ625 connected	100 titles
CDC655Tz connected	100 titles
CDC1255z connected	50 titles

Operations Common to Each Mode

- Press the [Function] button to select the mode you want to enter a title (TUNER, CD, CD changer or TV).
- Select and play a CD in the CD changer or tune in to a TV station for which you want to enter the title.
- Press the [Display] button and display the title.
- Press the [Title] button.
- Press the [◀◀] or [▶▶] button to move the cursor.
- Press the [Display] button to select a character. Each time you press the [Display] button, the character changes in the following order: Capital letters → Small letters → Numbers and Symbols → Capital letters...
- Turning the [Rotary] knob to select the desired character.
- Repeat steps 5 to 7 to enter up to 10 characters for the title.
- Press and hold the [▶/II] button for 2 seconds or longer to store the title into memory and cancel title input mode.

Clearing titles

- Select and play a CD in the CD changer or tune in to a TV station for which you want to clear the title.
- Press the [Display] button and display the title.
- Press the [Title] button. The display switches to the title input display.
- Press the [Band] button.
- Press and hold the [▶/II] button for 2 seconds or longer to clear the title and cancel title input mode.

AUX function

This system has an external input jack so you can listen to sounds and music from external devices connected to this unit.

7. OPERATIONS OF ACCESSORIES

CD/MD Changer Operations

CD/MD changer functions

When an optional CD/MD changer is connected through the CeNET cable, this unit controls all CD/MD changer functions. This unit can control a total of 2 changers.

Press theh **[Function]** button and select the CD(MD) changer mode to start play. If 2 CD(MD) changers are connected, press the **[Function]** button to select the CD(MD) changer for play.

- * If **"NO MAGAZINE"** appears in the display, insert the magazine into the CD changer. **"DISC CHECK"** appears in the display while the player loads (checks) the magazine.
- * If **"NO DISC"** appears in the display, eject the magazine and insert discs into each slot. Then, reinsert the magazine back into the CD changer.
- * If **"NO DISC"** appears in the display, load MDs into the MD changer.

Note:

- Some CDs recorded in CD-R/CD-RW mode may not be usable.

⚠ CAUTION

CD-ROM discs cannot be played from every CD changer, it's depended on the model.

Pausing play

1. Press the **[▶/II]** button to pause play. **"PAUSE"** appears in the display.
2. To resume play, press the **[▶/II]** button again.

Displaying CD titles

This unit can display title data for CD-text CDs and user titles input with this unit.

- * Title data for CD-text CDs can be displayed with this unit only when it is connected to DCZ625 or CDC655Tz.

●When connected to CDC655z or CDC1255z.

Press the **[Display]** button to display the title.

●When connected to DCZ625 or CDC655Tz

1. Press the **[Display]** button to display the title.
2. Each time you press and hold the **[Display]** button for 1 second or longer, the title display changes in the following order:

User title (disc) → CD-text title (disc) → Artist title → CD-text title (track) → user title (disc)...

Notes:

- If the CD playing is not a CD-text CD or no user title has been input, **"NO TITLE"** appears in the display.
- If a CD-text CD is not input its disc title or a track title, **"NO TITLE"** appears in the display.

Switching disc titles and track titles (MD)

This unit can display disc titles and track titles already entered on MDs.

- * Titles cannot be entered for MDs with this unit.

1. Press **[Display]** button to display the title. The disc title or track title is displayed.
2. Each time you press and hold the **[Display]** button for 1 second or longer, the display toggles between the disc title and the track title.

Note:

- If an MD is not input its disc title or a track title, **"NO TITLE"** appears in the display.

Procedure to scroll a title

Set **"SCROLL"** to **"ON"** or **"OFF"**.

(The factory default setting is **"ON"**. Refer to the subsection **"Turning the screen saver function on or off"** in section **"Operation common to each mode"**.)

●When set to **"ON"**

The title is automatically kept scrolling.

●When set to **"OFF"**

Press the **[Title]** button to scroll the title.

Selecting a DISC

1. Turning the **[Preset]** knob and press the **[Band]** button.

Selecting a track

●Track-up

1. Press the **[▶▶]** button to move ahead to the beginning of the next track.
2. Each time you press the **[▶▶]** button, the track advances ahead to the beginning of the next track.

●Track-down

1. Press the **[◀◀]** button to move back to the beginning of the current track.
2. Press the **[◀◀]** button twice to move to the beginning of the previous track.

Fast-forward/fast-backward

●Fast-forward

Press and hold the **[▶▶]** button for 1 second or longer.

●Fast-backward

Press and hold the **[◀◀]** button for 1 second or longer.

Scan play

Scan play locates and plays the first 10 seconds of each track on a disc automatically. This function continues on the disc until it is cancelled.

- * The scan play is useful when you want to select a desired track.

1. Press the **[Scan]** button to start track scanning. **"SCN"** lights in the display.
2. To cancel the scan play, press the **[Scan]** button again. **"SCN"** goes off from the display and the current track continues to play.

Disc scan play

Disc scan play locates and plays the first 10 seconds of the first track on each disc in the currently selected CD (MD) changer. This function continues automatically until it is cancelled.

- * Disc scan play is useful when you want to select a desired CD (MD).

1. Press and hold the **[Scan]** button for 1 second or longer. **"DISC ▶"** and **"SCN"** light in the display and disc scan play starts.
2. To cancel disc scan play, press the **[Scan]** button again. **"DISC ▶"** and **"SCN"** go off from the display and the current track continues to play.

Repeat play

Repeat play continuously plays the current track. This function continues automatically until it is cancelled.

1. Press the **[Repeat]** button. **"RPT"** lights in the display and the current track is repeated.
2. To cancel repeat play, press the **[Repeat]** button again. **"RPT"** goes off from the display and normal play resumes.

Disc repeat play

After all the tracks on the current disc have been played, disc repeat play automatically replays the current disc over from the first track. This function continues automatically until it is cancelled.

1. Press and hold the **[Repeat]** button for 1 second or longer. **"DISC ▶"** and **"RPT"** light in the display and disc repeat play starts.
2. To cancel disc repeat play, press and hold the **[Repeat]** button again. **"DISC ▶"** and **"RPT"** go off from the display and normal play resumes on the current track.

Random play

Random play selects and plays individual tracks on the disc in no particular order. This function continues automatically until it is cancelled.

1. Press the **[Random]** button. **"RDM"** lights in the display and random play begins.
2. To cancel random play, press the **[Random]** button again. **"RDM"** goes off from the display and normal play resumes.

Disc random play

The disc random play selects and plays individual tracks or discs automatically in no particular order. This function continues automatically until it is cancelled.

1. Press and hold the **[Random]** button for 1 second or longer. **"DISC ▶"** and **"RDM"** light in the display and disc random play starts.
2. To cancel disc random play, press and hold the **[Random]** button again. **"DISC ▶"** and **"RDM"** go off from the display and normal play resumes from the current track.

TV tuner functions

When an optional TV tuner is connected through the CeNET cable, this unit controls all TV tuner functions. To watch TV requires a TV tuner and monitor.

Watching a TV

1. Press the [**Function**] button and select the TV mode.
2. Press the [**Band**] button to select the desired TV band (TV1 or TV2). Each time the button is pressed, the input selection toggles between TV1 and TV2.
3. Press the [◀◀] or [▶▶] button to tune in the desired TV station.

Tuning

There are 3 types of tuning mode available, Seek tuning, manual tuning and preset tuning.

Seek tuning

1. Press the [**Band**] button and select the desired TV band (TV1 or TV2).
 - * If "MANU" is lit in the display, press and hold the [**Band**] button for 1 second or longer. "MANU" in the display goes off and seek tuning is now available.
2. Press the [◀◀] or [▶▶] button to automatically seek a station. Press the [▶▶] button to automatically tune up the frequency band to the next available TV station; press the [◀◀] button to automatically tune down.

Manual tuning

There are 2 ways available: Quick tuning and step tuning.

When you are in the step tuning mode, the frequency changes one step at a time. In the quick tuning mode, you can quickly tune the desired frequency.

1. Press the [**Band**] button and select the desired band (TV1 or TV2).
 - * If "MANU" is not lit in the display, press and hold the [**Band**] button for 1 second or longer. "MANU" lights in the display and manual tuning is now available.
2. Tune into a station.

● Quick tuning:

Press and hold the [◀◀] or [▶▶] button for 1 second or longer to tune in a station.

● Step tuning:

Press the [◀◀] or [▶▶] button to manually tune in a station.

Preset tuning

A total of 12 TV stations can be stored (6-TV1 and 6-TV2). This allows you to select your favorite TV stations and store them in memory for later recall.

1. Press the [**Band**] button and select the desired TV band (TV1 or TV2).
2. Turning the [**Preset**] knob to select a TV station to start with.

Manual memory

1. Press the [**Band**] button and select the desired TV band (TV1 or TV2).
2. Press [◀◀] or [▶▶] button to select a station to be put into memory. Then, press the [**Memory**] button.
3. Turning the [**Preset**] a preset memory number to be registered.
4. Press and hold the [**Memory**] button (for about 2 seconds).
 - * After a registration is completed, "CH" indication becomes lit in the display from the blinking status.

Auto store

Auto store selects 6 TV stations automatically and stores each one into preset memory.

If there are not 6 stations with good reception, stations previously stored in memory remain and only the strong stations are stored into memory.

1. Press the [**Band**] button and select the desired TV band (TV1 or TV2).
2. Press and hold the [**Scan**] button for 2 seconds or longer. The stations with good reception are stored automatically to the preset channels.

Preset scan

Preset scan allows the user to view each preset position before it automatically advances to the next preset. This function is useful for searching for a desired TV station in memory.

1. Press the [**Scan**] button.
2. When the desired station is found, press the [**Scan**] button again to remain tuned to that station.

Note:

• Do not press and hold the [**Scan**] button for 2 seconds or longer. Doing so will trigger the auto store function and start storing stations into memory.

Setting the TV diver

You can change the reception setting for the TV antenna connected to the TV tuner.

1. Press and hold the [**Title**] button for 1 second or longer to switch to the adjustment selection display.
2. Press the [◀◀] or [▶▶] button to select "TV DIVER".
3. Turning the [**Rotary**] knob clockwise to "ON" or counterclockwise to "OFF".
 - ON:
Sets the diver setting to ON.
 - OFF:
Sets the diver setting to OFF.
4. Press the [**Title**] button to return to the previous mode.

Setting the TV area

When you select the TV area (TV reception area), the TV tuner area setting changes.

1. Press and hold the [**Title**] button for 1 second or longer to switch to the adjustment selection display.
2. Press the [◀◀] or [▶▶] button to select "TV AREA".
3. Press the [▶/||] button.
4. Turning the [**Rotary**] knob clockwise or counterclockwise to select the reception area.
5. Press the [▶/||] button.
6. Press the [**Title**] button to return to the previous mode.

* The above operations are required when a TV tuner other than TTX7501z is connected.

Watching a video

The TV tuner has a VTR input terminal to which 1 external device can be connected. Connect a 12 V video cassette player (VCP) or video cassette recorder (VCR) to the TV tuner input terminal.

1. Press the [**Random**] button to select VTR.
2. To return to the TV broadcast, press the [**Random**] button.

8. IN CASE OF DIFFICULTY

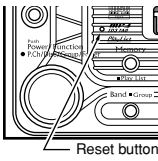
	Problem	Cause	Measure
General	Power does not turn on. (No sound is produced.)	Fuse is blown.	Replace with a fuse of the same amperage. If the fuse blows again, consult your store of purchase.
		Incorrect wiring.	Consult your store of purchase.
	No sound output when operating the unit with amplifiers or power antenna attached.	Power antenna lead is shorted to ground or excessive current is required for remote-on the amplifiers or power antenna.	<ol style="list-style-type: none"> Turning the unit off. Remove all wires attached to the power antenna lead. Check each wire for a possible short to ground using an ohm meter. Turning the unit back on. Reconnect each amplifier remote wire to the power antenna lead one by one. If the amplifiers turn off before all wires are attached, use an external relay to provide remote-on voltage (excessive current required).
	Nothing happens when buttons are pressed. Display is not accurate.	The microprocessor has malfunctioned due to noise, etc.	Press the reset button for about 2 seconds with a thin rod. 
No sound heard	The speaker protection circuit is operating.	<ol style="list-style-type: none"> Turn down sound volume. Function can also be restored by turning the power off and on again. (Speaker volume is reduced automatically when the speaker protection circuit operates). If the sound is muted again, consult our service department. 	
CD/MP3	No sound heard	MP3/WMA files are absent in a disc.	Write MP3/WMA files onto the disc properly.
		Files are not recognized as an MP3/WMA file.	Use MP3/WMA files encoded properly.
		File system is not correct.	Use ISO9660 level 1, 2, 3 or JOLIET or Romeo file system.
	Sound skips or is noisy.	Compact disc is dirty.	Clean the compact disc with a soft cloth.
		Compact disc is heavily scratched or warped.	Replace with a compact disc with no scratches.
	Sound is cut or skipped. Noise is generated or noise is mixed with sound.	MP3/WMA files are not encoded properly.	Use MP3/WMA files encoded properly.
	Sound is bad directly after power is turned on.	Water droplets may form on the internal lens when the car is parked in a humid place.	Let dry for about 1 hour with the power on.
Wrong filename	File system is not correct.	Use ISO9660 level 1, 2, 3 or JOLIET or Romeo file system.	
Play list play is not performed.	File name or extension is not correct.	Use alphanumeric/ASCII characters for MP3/WMA file name. Use ".M3U" or ".ASX" for the file extension of a play list.	

	Problem	Cause	Measure
MD	MD cannot be loaded.	Another MD is already loaded.	Eject the MD before loading the new one.
		MD inserted wrongly.	Insert correctly.
	Sound skips or is noisy.	MD is heavily scratched or warped.	Replace with an MD with no scratches.
	Sound is bad directly after power is turned on.	Water droplets may form on the internal lens when the car is parked in a humid place.	Let dry for about 1 hour with the power on.

9. ERROR DISPLAYS

If an error occurs, one of the following displays is displayed.
Take the measures described below to eliminate the problem.

	Error Display	Cause	Measure
CD/MP3	ERROR 2	A CD is caught inside the CD deck and is not ejected.	This is a failure of CD deck's mechanism and consult your store of purchase.
	ERROR 3	A CD cannot be played due to scratches, etc.	Replace with a non-scratched, non-warped-disc.
	ERROR 6	A CD is loaded upside-down inside the CD deck and does not play.	Eject the disc then reload it properly.
MD	ERROR H	Displayed when the temperature in the MD deck's mechanism is too high and playback has been stopped automatically.	Lower the surrounding temperature and wait for a while to cool off MD deck's mechanism.
	ERROR 2	An MD inside the MD deck is not loaded.	This is a failure of MD deck's mechanism and consult your store of purchase.
	ERROR 3	An MD cannot be played due to scratches, etc.	Replace with a non-scratched, non-warped disc.
CD changer	ERROR 2	A CD inside the CD changer is not loaded.	This is a failure of CD changer's mechanism and consult your store of purchase.
	ERROR 3	A CD inside the CD changer cannot be played due to scratches, etc.	Replace with a non-scratched, non-warped disc.
	ERROR 6	A CD inside the CD changer cannot be played because it is loaded upside-down.	Eject the disc then reload it properly.
MD changer	ERROR H	Displayed when the temperature in the MD changer is too high and playback has been stopped automatically.	Lower the surrounding temperature and wait for a while to cool off MD changer.
	ERROR 2	An MD inside the MD changer is not loaded.	This is a failure of MD changer's mechanism and consult your store of purchase.
	ERROR 3	An MD inside the MD changer cannot be played due to scratches, etc.	Replace with a non-scratched, non-warped disc.
	ERROR 6	An MD inside the MD changer cannot be played because it is loaded upside-down.	Eject the disc then reload it properly.
		Displayed when a non-recorded MD is loaded in the MD changer.	Load a pre-recorded MD in the MD changer.

	Error Display	Cause	Measure
DVD changer	ERROR 2	A DISC inside the DVD changer cannot be played.	This is a failure of DVD mechanism and consult your store of purchase.
	ERROR 3	A DISC cannot be played due to scratches, etc.	Retry or replace with a non-scratched, non-warped-disc.
	ERROR 6	A DISC inside the DVD changer cannot be played because it is loaded upside-down.	Eject the disc then reload it properly
	ERROR P	Parental level error	Set the correct Parental level.
	ERROR R	Region code error	Eject the disc and replace correct region code disc.

If an error display other than the ones described above appears, press the reset button. If the problem persists, turn off the power and consult your store of purchase.

10. SPECIFICATIONS

FM Tuner

Frequency Range:
87.0 MHz to 108 MHz

Usable Sensitivity:
9 dBf

50dB Quieting Sensitivity:
15 dBf

Alternate Channel Selectivity:
70 dB

Stereo Separation (1 kHz):
35 dB

Frequency Response (± 3 dB):
30 Hz to 15 kHz

AM Tuner

Frequency Range:
531 kHz to 1629 kHz

Usable Sensitivity:
25 μ V

CD Player

Frequency Response (± 1 dB):
5 Hz to 20 kHz

Signal to Noise Ratio (1 kHz):
100 dBA

Dynamic Range (1 kHz):
95 dB

Harmonic Distortion:
0.01%

Channel Separation (1 kHz):
85 dB

MD Player

Frequency Response (± 1 dB):
20 Hz to 20 kHz

Signal to Noise Ratio (1 kHz):
90 dBA

Dynamic Range (1 kHz):
85 dB

Harmonic Distortion:
0.01%

Audio

Maximum Power Output:
200 W (50 W \times 4 ch)

Continuous Average Power Output:
17 W \times 4, into 4 Ω , 20 Hz to 20 kHz, 1%THD

Bass Control Action (60 Hz/100 Hz/200 Hz):
+16 dB, -12dB

Treble Control Action (10 kHz/15 kHz):
 ± 12 dB

Line Output Level (CD 1 kHz):
1.8 V

General

Power Supply Voltage:
14.4 V DC (10.8 to 15.6 V allowable), negative ground

Current Consumption:
Less than 15 A, 3A

Speaker Impedance:
4 Ω (4 Ω to 8 Ω allowable)

Weight / Source unit:
4.84 lb. (2.2 kg)

Weight / Remote control unit:
1 oz. (30 g) (including battery)

Dimensions / Source unit:
7" (Width) \times 3-15/16" (Height) \times 6-3/16" (Depth)
[178 (W) \times 100 (H) \times 156.5 (D) mm]

Dimensions / Remote control unit:
1-3/4" (Width) \times 4-5/16" (Height) \times 1-1/16" (Depth)
[44 (W) \times 110 (H) \times 27 (D) mm]

Notes:

- Specifications and design are subject to change without notice for further improvement.
- U.S. and foreign patents licensed from Dolby Laboratories Licensing Corporation.

Free Manuals Download Website

<http://myh66.com>

<http://usermanuals.us>

<http://www.somanuals.com>

<http://www.4manuals.cc>

<http://www.manual-lib.com>

<http://www.404manual.com>

<http://www.luxmanual.com>

<http://aubethermostatmanual.com>

Golf course search by state

<http://golfingnear.com>

Email search by domain

<http://emailbydomain.com>

Auto manuals search

<http://auto.somanuals.com>

TV manuals search

<http://tv.somanuals.com>