

Clarion®

Owner's manual
Mode d'emploi
Manual de instrucciones

DRX8575Z

AM/FM CD PLAYER
WITH CD/MD CHANGER CONTROL

COMBINÉ RADIO/CD AM/FM AVEC PILOTE
DE CHANGEUR CD/MD

RADIO DE AM/FM Y REPRODUCTOR DE DISCOS
COMPACTOS CON CONTROL DE CAMBIADOR
DE DISCOS COMPACTOS/MINIDISCOS

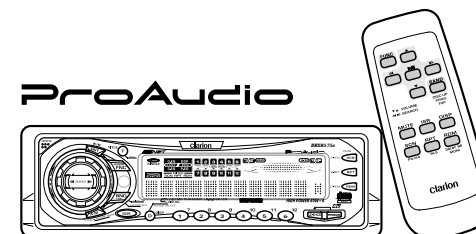

ProAudio



Clarion Co., Ltd.

All Rights Reserved. Copyright © 1998: Clarion Co., Ltd.
Printed in China / Imprimé en Chine / Inpreso en China

PE-2171B
280-7229-00

Thank you for purchasing the **Clarion DRX8575z**.

- * Please read this owner's manual in its entirety before operating this equipment.
- * After reading this manual, be sure to keep it in a handy place (e.g., glove compartment).
- * Check the contents of the enclosed warranty card and keep it carefully with this manual.
- * This manual includes the operating procedures of the CD changer, MD changer, TV tuner and digital sound processor (DSP) connected via the CeNET cable. The CD changer, MD changer, TV tuner and DSP have their own manuals, but no explanations for operating them are described.

Contents

1. FEATURES	2
2. PRECAUTIONS	3
Handling Compact Discs	4
Flip Down Panel	4
3. CONTROLS	5
4. NOMENCLATURE	6
Names of Buttons	6
Display Items	6
5. DCP	7
6. REMOTE CONTROL	8
Inserting the Batteries	8
Function of Remote Control Unit Buttons	9
7. OPERATIONS	10
Basic Operations	10
Radio Operations	13
CD Operations	14
Other Handy Functions	16
8. OPERATIONS OF ACCESSORIES	18
CD Changer Operations	18
MD Changer Operations	20
TV Operations	21
DSP Operations	23
9. TROUBLESHOOTING	27
10. ERROR DISPLAYS	28
11. SPECIFICATIONS	29

1. FEATURES

- Rotary Encoder Volume Control with Multi-Color Prism Key
- Touch-n-Go Flip Down Detachable Face
- Controller for Optional DSP/EQ & TV Tuner Modules
- Built-In CD TEXT, Also Reads CD TEXT Data from Clarion Compatible CD Changer
- Z-Enhancer with 3 Adjustment Modes
- CeNET with Balanced Audio Line Transmission and Dynamic Noise Canceling
- **MAGI-TUNEC**® FM Reception System
- 8-Times Oversampling Digital Filter and Dual 1-Bit D/A Converters
- Zero-Bit Detector™ Mute Circuit
- 4V/4-Channel RCA Line Level Output with Fader Control
- 4V/2-Channel Non-Fade RCA Line Level Output with Volume Control
- 180W(45×4) Maximum Power Output

6. REMOTE CONTROL

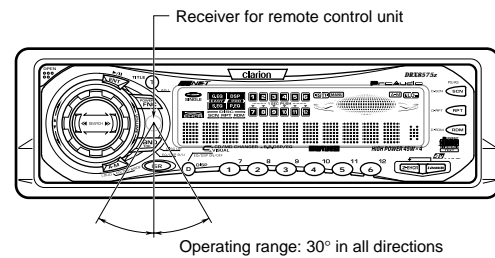

Remote control unit

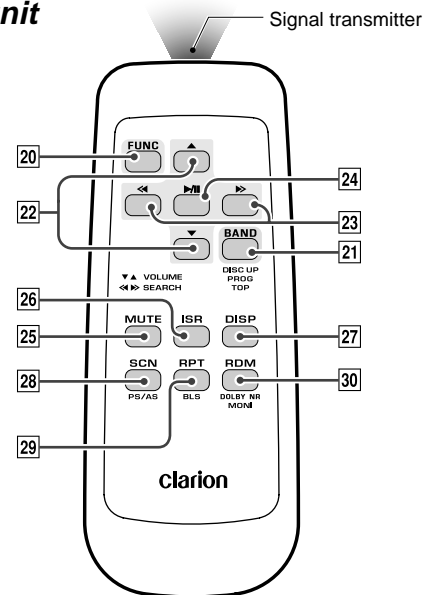

Inserting the Batteries

1. Turn the remote control unit over, then slide the rear cover in the direction of the arrow.
2. Insert the AA (UM-3/1.5V) batteries that came with the remote control unit facing in the directions shown in the figure, then close the rear cover.

Notes:

Using batteries improperly can cause them to explode. Take note of the following points:

- When replacing batteries, replace both batteries with new ones.
- Do not short-circuit, disassemble or heat batteries.
- Do not dispose of batteries into fire or water.
- Dispose of spent batteries properly.

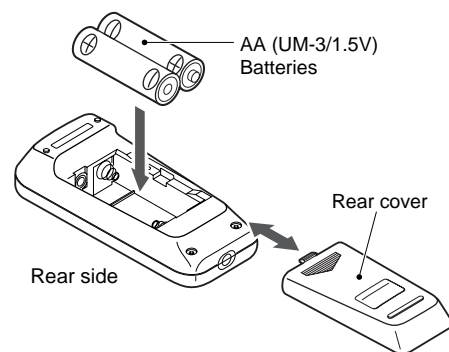

2. PRECAUTIONS

1. When the inside of the car is very cold and the player is used soon after switching on the heater moisture may form on the disc or the optical parts of the player and proper playback may not be possible. If moisture forms on the disc, wipe it off with a soft cloth. If moisture forms on the optical parts of the player, do not use the player for about one hour. The condensation will disappear naturally allowing normal operation.
2. Driving on extremely bumpy roads which cause severe vibration may cause the sound to skip.
3. When the auto antenna cord is connected to the car auto antenna cord, when the unit is switched to the radio mode (or the TV mode), the antenna is extended automatically. If the car is in a narrow space, the antenna may strike something, so be careful.
4. This unit uses a precision mechanism. Even in the event that trouble arises, never open the case, disassemble the unit, or lubricate the rotating parts.

This equipment has been tested and found to comply with the limits for a Class B digital device, pursuant to Part 15 of the FCC Rules.

These limits are designed to provide reasonable protection against harmful interference in a residential installation.

This equipment generates, uses, and can radiate radio frequency energy and, if not installed and used in accordance with the instructions, may cause harmful interference to radio communications. However, there is no guarantee that interference will not occur in a particular installation.

If this equipment does cause harmful interference to radio or television reception, which can be determined by turning the equipment off and on, the user is encouraged to consult the dealer or an experienced radio/TV technician for help.

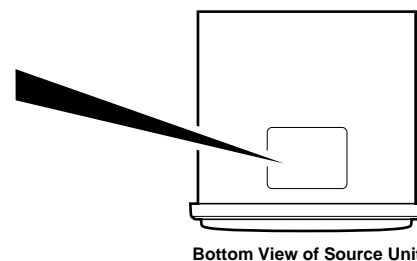

Bottom View of Source Unit

CAUTION

USE OF CONTROLS, ADJUSTMENTS, OR PERFORMANCE OF PROCEDURES OTHER THAN THOSE SPECIFIED HEREIN, MAY RESULT IN HAZARDOUS RADIATION EXPOSURE.

THE COMPACT DISC PLAYER and MINI DISC PLAYER SHOULD NOT BE ADJUSTED OR REPAIRED BY ANYONE EXCEPT PROPERLY QUALIFIED SERVICE PERSONNEL.

CHANGES OR MODIFICATIONS NOT EXPRESSLY APPROVED BY THE MANUFACTURER FOR COMPLIANCE COULD VOID THE USER'S AUTHORITY TO OPERATE THE EQUIPMENT.

INFORMATION FOR USERS:

CHANGES OR MODIFICATIONS TO THIS PRODUCT NOT APPROVED BY THE MANUFACTURER WILL VOID THE WARRANTY AND WILL VIOLATE FCC APPROVAL.

Handling Compact Discs

Use only compact discs bearing the mark.

Do not play heart-shaped, octagonal, or other specially shaped compact discs.

Handling

- New discs may have some roughness around the edges. If such discs are used, the player may not work or the sound may skip. Use a ball-point pen or the like to remove any roughness from the edge of the disc.

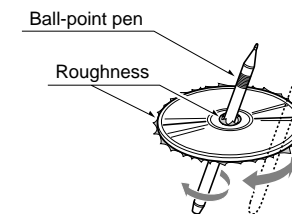

- Never stick labels on the surface of the compact disc or mark the surface with a pencil or pen.
- Never play a compact disc with any cellophane tape or other glue on it or with peeling off marks. If you try to play such a compact disc, you may not be able to get it back out of the CD player or it may damage the CD player.
- Do not use compact discs that have large scratches, are misshapen, cracked, etc. Use of such discs may cause misoperation or damage.

- To remove a compact disc from its storage case, press down on the center of the case and lift the disc out, holding it carefully by the edges.
- Do not use commercially available CD protection sheets or discs equipped with stabilizers, etc. These may damage the disc or cause breakdown of the internal mechanism.

Storage

- Do not expose compact discs to direct sunlight or any heat source.
- Do not expose compact discs to excess humidity or dust.
- Do not expose compact discs to direct heat from heaters.

Cleaning

- To remove fingermarks and dust, use a soft cloth and wipe in a straight line from the center of the compact disc to the circumference.
- Do not use any solvents, such as commercially available cleaners, anti-static spray, or thinner to clean compact discs.
- After using special compact disc cleaner, let the compact disc dry off well before playing it.

Flip Down Panel

The DRX8575z use a flip-down structure that makes possible large-size displays.

CAUTION

When opening and closing the FLIP DOWN PANEL, be careful not to catch your fingers. They could be injured.

1. Always use the DRX8575z with the FLIP DOWN PANEL closed.
2. Do not force operations or use this device abnormally when opening or closing the FLIP DOWN PANEL.

3. Do not use the FLIP DOWN PANEL as a tray to place objects on when it is open.
4. When closing the FLIP DOWN PANEL, do not press OPEN button .
5. Strong impacts to the operating or display section can cause damage or deformation.
6. If the FLIP DOWN PANEL does not open fully, gently open it with your hand.

Be sure to unfold and read the next page.
Veuillez déplier et vous référer à la page suivante.
Cerciórese de desplegar y de leer la página siguiente.

3. CONTROLS / LES COMMANDES / CONTROLES

Source unit / Appareil pilote / Unidad fuente

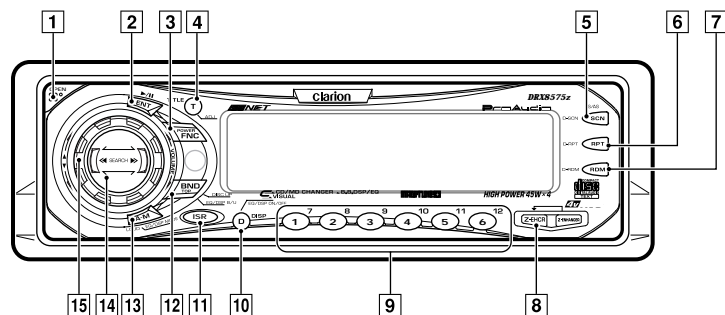

With the FLIP DOWN PANEL opened / Ouverture du PANNEAU RABATTABLE / Apertura del PANEL ABATIBLE

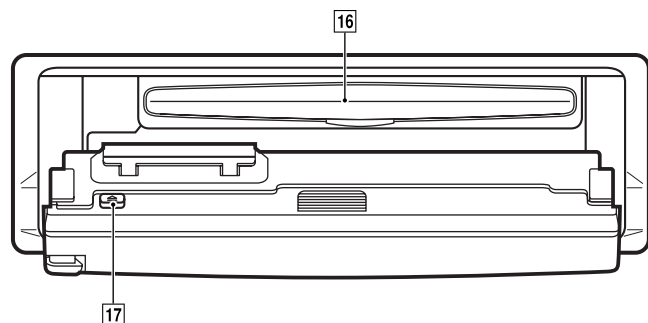

Display / Afficheur / Visualizador

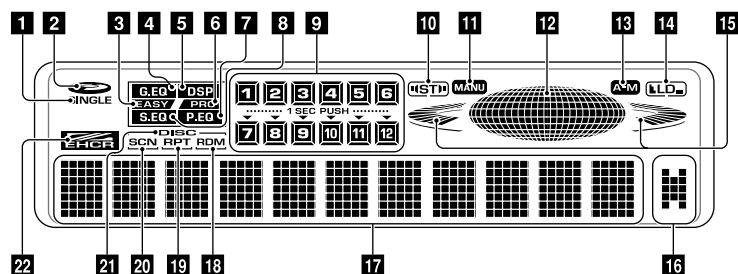

Note: Be sure to unfold this page and refer to the front diagrams as you read each chapter.

Remarque: Veuillez déplier cette page et vous référer aux schémas quand vous lisez chaque chapitre.

Nota: Cuando lea los capítulos, despliegue esta página y consulte los diagramas.

4. NOMENCLATURE

Note:

• Be sure to read this chapter referring to the front diagrams of chapter "3. CONTROLS" on page 5 (unfold).

Names of Buttons

- | | |
|---|--|
| 1 OPEN button | 9 Preset buttons (1 to 6) |
| 2 ENT (enter) button | Direct buttons (1 to 6) (7 to 12) |
| 3 POWER button | 10 DISP (display) button |
| FNC (function) button | 11 ISR (instant station recall) button |
| 4 TITLE button | 12 BND (band) button |
| ADJ (adjust) button | TOP button |
| 5 PS/AS (preset scan/auto store) button | 13 A-M (audio mode) button |
| SCN (scan) button | LOUD (loudness) button |
| 6 RPT (repeat) button | 14 SEARCH button |
| 7 RDM (random) button | 15 Rotary knob |
| 8 Z-EHCR (z-enhancer) button | 16 CD insertion slot |
| | 17 Eject button |

Display Items

- | | |
|--|--|
| 1 Single disc indication | 13 A-M (audio mode) indication |
| 2 Disc in indication | 14 LD (loudness) indication |
| 3 Easy mode indication | 15 Graphic indication |
| 4 G.EQ indication | * Levels are displayed in adjusting the volume, etc. |
| 5 DSP indication | 16 Long title indication |
| 6 Pro mode indication | * When the texts for CD or MD are more than 11 characters, this indication lights. |
| 7 P.EQ indication | 17 Operation status indication |
| 8 S.EQ indication | * The frequency, play time, clock, etc. are displayed. |
| 9 Preset channel indication (1 to 6) | 18 RDM (random) indication |
| Disc number indication (1 to 12) | 19 RPT (repeat) indication |
| * The disc numbers corresponding to the discs in the CD or MD changer light. | 20 SCN (scan) indication |
| 10 ST (stereo) indication | 21 DISC indication |
| 11 MANU (manual) indication | 22 Z-EHCR (z-enhancer) indication |
| 12 Function mode indication | |
| * The names of modes being selected, etc. are displayed. | |

5. DCP

The control panel can be detached to prevent theft. When detaching the control panel, store it in the DCP (DETACHABLE CONTROL PANEL) case to prevent scratches.

We recommend taking the DCP with you when leaving the car.

Removing the DCP

1. Hold down POWER button 3 for 1 second or longer to turn off the power.

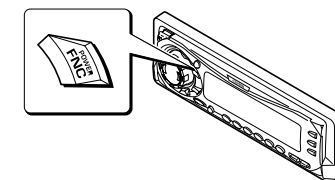

2. Deeply push in OPEN button 1 to unlock the DCP.

* If the FLIP DOWN PANEL does not open fully, gently open it with your hand.

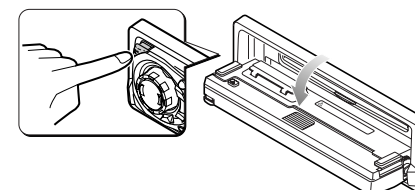

3. Pull the DCP toward you and remove it.

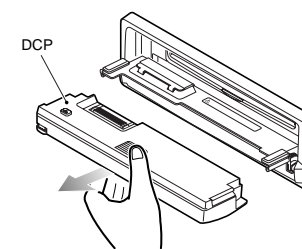

4. Close the HOLD FLAP.

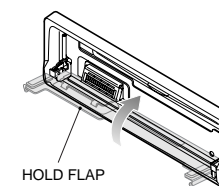

Attaching the DCP

1. Insert the right side of the DCP into the source unit.
2. Insert the left side of the DCP into the source unit.

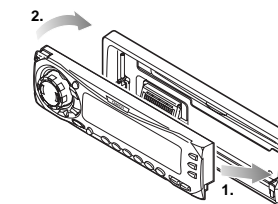

CAUTION

• The DCP can easily be damaged by shocks. After removing it, be careful not to drop it or subject it to strong shocks.

• If the FLIP DOWN PANEL is kept open, the DCP may drop due to vibration of the car.

This results in damage to the DCP. So close the FLIP DOWN PANEL or remove the DCP to store into the case.

• The connector connecting the source unit and the DCP is an extremely important part. Be careful not to damage it by pressing on it with fingernails, screwdrivers, etc.

Note:

• If the DCP is dirty, wipe off the dirt with a soft, dry cloth only.

CAUTION

Be sure to close the HOLD FLAP for safety when removing the DCP.

Functions of Remote Control Unit Buttons

Button	Mode	Radio	CD	CD changer MD changer	TV
20	FUNC	Turns power on and off. When pressed and held for 1 second: Turns power off. Switches among radio, CD, CD changer, MD changer and TV.			
21	BAND DISC UP PROG TOP	Switches reception band.	Plays the first track. Top play.	Moves the next disc in increasing order.	Switches reception band.
22	VOLUME	Increases and decreases volume (in all modes).			
23	SEARCH	Moves preset channels up and down.	Moves tracks up and down. When pressed and held for 1 second: Fast-forward/ fast-backward.	Moves tracks up and down. When pressed and held for 1 second: Fast-forward/ fast-backward.	Moves preset channels up and down.
24	PLAY/PAUSE	No function	Switches between playback and pause.	Switches between playback and pause.	No function
25	MUTE	Turns mute on and off.			
26	ISR	Recalls ISR radio station in memory. Press and hold for 2 seconds or longer: Stores current station into ISR memory (radio mode only).			
27	DISP	Switches among main display, sub display, clock display and spectrum analyzer display (only when connected to DPH7500z).			
28	SCN PS/AS	Preset scan. When pressed and held for 2 seconds: Auto store.	Scan play.	Scan play. When pressed and held for 2 seconds: Disc scan play.	Preset scan. When pressed and held for 2 seconds: Auto store.
29	RPT BLS	No function	Repeat play.	Repeat play. When pressed and held for 2 seconds: Disc repeat play.	No function.
30	RDM DOLBY NR MONI	No function	Random play.	Random play. When pressed and held for 2 seconds: Disc random play.	Switches between TV and VTR.

* Some of the corresponding buttons on the source unit and remote control unit have different functions.

7. OPERATIONS

Basic Operations

Note: Be sure to read this chapter referring to the front diagrams of chapter "3. CONTROLS" on page 5 (unfold).

⚠ CAUTION

Be sure to lower the volume before switching off the unit power or the ignition key. The unit remembers its last volume setting. If you switch the power off with the volume up, when you switch the power back on, the sudden loud volume may hurt your hearing and damage the unit.

The clock is displayed when the ignition key is turned to the ACC (accessory) or IGN (ignition-on) position even when the unit power is off. In some cars, the clock may momentarily disappear when the ignition key is turned to the START position. The clock will reappear after the engine has started and the ignition key is released to the IGN (ignition-on) position.

Turning on/off the power

Note:

• Be careful about using this unit for a long time without running the engine. If you drain the car's battery too far, you may not be able to start the engine and this can reduce the service life of the battery.

1. Press POWER button [3].
2. The illumination and display on the unit light up. The unit automatically remembers its last operation mode and will automatically switch to display that mode.
3. Press and hold POWER button [3] for 1 second or longer to turn off the power for the unit.

Note:

• System check

The first time this unit is switched on after the wire connections are completed, it must check what equipment is connected. When the power is switched on, "SYSTEM CHCK" is displayed on the display, so press POWER button [3]. The system check starts within the unit. When the system check is complete, the power is switched off, so press POWER button [3] again.

Selecting a mode

1. Press FNC button [3] to change the mode of operation.
2. Each time you press FNC button [3], the mode of operation changes in the following order:

Radio mode → CD mode → CD changer mode → MD changer mode → TV mode → Radio mode...

* External equipment not connected with CeNET is not displayed.

Adjusting the volume

Turning the Rotary knob [15] clockwise increases the volume; turning it counterclockwise decreases the volume.

* The volume level is from 0 (minimum) to 33 (maximum).

Switching the display

Press DISP button [10] to select the desired display. Each time you press DISP button [10], the display switches in the following order:

Main display



Sub (title) display



Clock display

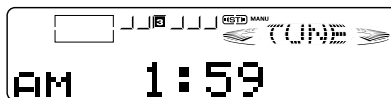

Spectrum analyzer display



Main display...

* The spectrum analyzer display is only displayed when the DPH7500z is connected.

- * Once selected, the preferred display becomes the display default. When a function adjustment such as volume is made, the screen will momentarily switch to that function's display, then revert back to the preferred display several seconds after the adjustment.
- * When you have entered a title in a CD, it appears in the sub display. If you have not entered a title, "NO-TITLE" appears in the title display instead. For information on how to enter a title, refer to the subsection "Entering titles" in "Other Handy Functions".

Setting the Z-enhancer

This unit comes with three types of sound tone effects stored in memory. Select the one you prefer.

- * The factory default setting is "Z-EHCR OFF".

Each time you press Z-EHCR button [8], the tone effect changes in the following order:

"Z-ENHANCER 1" → "Z-ENHANCER 2" → "Z-ENHANCER 3" → "Z-EHCR OFF" → "Z-ENHANCER 1"...

- Z-ENHANCER 1: bass emphasized
- Z-ENHANCER 2: treble emphasized
- Z-ENHANCER 3: bass and treble emphasized
- Z-EHCR OFF: no sound effect

Adjusting the tone

Press A-M button [13] and select the item to adjust. Each time you press A-M button [13], the item changes in the following order:

- When the Z-enhancer and tone bypass are off
"NON-FAD VOL" → "TONE BYPASS" → "BASS" → "TREBLE" → "BALANCE" → "FADER" → Function mode...

- When Z-enhancer 1, 2, or 3 is set
"NON-FAD VOL" → "Z-EHCR" → "BALANCE" → "FADER" → Function mode...

Note:

- When the separately-sold digital sound processor (DPH7500) is used, the tone bypass, bass and treble tone adjustments cannot be selected. To adjust the tone, see the chapter "DSP Operations".

Adjusting the non-fader output volume

You can adjust the volume output from the unit's non-fader output terminal.

1. Press A-M button [13] and select "NON-FAD VOL".
2. Turning the Rotary knob [15] clockwise increases the output volume; turning it counterclockwise decreases the output volume.
 - * The factory default setting is "4". (Setting range: 0 to 7)

3. When the adjustment is complete, press A-M button [13] several times until the function mode is reached.

Setting tone bypass

The tone bypass disables the tone (bass and treble) functions and cuts the noise generated when the tone functions are on.

1. Press A-M button [13] and select "TONE BYPASS".
2. Turning the Rotary knob [15] clockwise sets the tone bypass to "YES" (ON); turning it counterclockwise sets the tone bypass to "NO" (OFF).
 - * The factory default setting is "NO" (OFF).
 - * If the setting is "YES" (ON), the bass and treble adjustments cannot be made.
3. When the adjustment is complete, press A-M button [13] several times until the function mode is reached.

Note:

- If you set the Z-ENHANCER function to ON (1 to 3), you cannot set the tone bypass.

Adjusting the bass

1. Press A-M button [13] and select "BASS".
2. Turning the Rotary knob [15] clockwise emphasizes the bass; turning it counterclockwise attenuates the bass.
 - * The factory default setting is "0". (Adjustment range: -6 to +6)
 - * The bass cannot be adjusted if the tone bypass setting is "YES" (ON).
3. When the adjustment is complete, press A-M button [13] several times until the function mode is reached.

Adjusting the treble

1. Press A-M button [13] and select "TREBLE".
2. Turning the Rotary knob [15] clockwise emphasizes the treble; turning it counterclockwise attenuates the treble.
 - * The factory default setting is "0". (Adjustment range: -6 to +6)
 - * The treble cannot be adjusted if the tone bypass setting is "YES" (ON).
3. When the adjustment is complete, press A-M button [13] several times until the function mode is reached.

Basic Operations

Adjusting the balance

1. Press A-M button **[13]** and select “**BALANCE**”.
2. Turning the Rotary knob **[15]** clockwise emphasizes the sound from the right speaker; turning it counterclockwise emphasizes the sound from the left speaker.
 - * The factory default setting is “0”. (Adjustment range: L13 to R13)
3. When the adjustment is complete, press A-M button **[13]** several times until the function mode is reached.

Adjusting the fader

1. Press A-M button **[13]** and select “**FADER**”.
2. Turning the Rotary knob **[15]** clockwise emphasizes the sound from the front speakers; turning it counterclockwise emphasizes the sound from the rear speakers.
 - * The factory default setting is “0”. (Adjustment range: F12 to R12)
3. When the adjustment is complete, press A-M button **[13]** several times until the function mode is reached.

Adjusting the Z-enhancer

1. Press Z-EHCR button **[8]** and select the Z-enhancer mode (1-3) to adjust.
2. Press A-M button **[13]** and select “**Z-EHCR**”.
3. Turning the Rotary knob **[15]** clockwise adjusts in the + direction; turning it counterclockwise adjusts in the - direction.
 - * When Z-Enhancer 1 is selected, you can adjust the bass in the range of ± 2 .
 - * When Z-Enhancer 2 is selected, you can adjust the treble in the range of ± 2 .
 - * When Z-Enhancer 3 is selected, you can adjust the bass and treble in the range of ± 2 .
4. When the adjustment is complete, press A-M button **[13]** several times until the function mode is reached.

Note:

- If you set the Z-ENHANCER function to ON (1 to 3), you cannot set the tone bypass.

Turning on and off the loudness

The loudness effect emphasizes the bass and treble to create a natural sound tone. When you are listening to music at a low volume, it is recommended to use the loudness effect.

1. Press and hold LOUD button **[13]** for 1 second or longer to turn on the loudness effect. When the loudness effect is turned on, “**LD**” illuminates in the display.
2. Press and hold LOUD button **[13]** for 1 second or longer to turn off the loudness effect. “**LD**” disappears in the display.

Note:

- When using a sold separately digital sound processor (DPH7500), a feature called auto loudness is selected. This function is different from the loudness effect. For further details on the auto loudness feature, refer to the subsection “**Output adjustment of auto loudness, subwoofer and playback band**”.

Changing the reception area

This unit is initially set to USA frequency intervals of 10kHz for AM and 200kHz for FM. When using it outside the USA, the frequency reception range can be switched to the intervals below.

● Setting the reception area

1. Press BND button [12] and select the desired radio band. (FM or AM)
2. While pressing RDM button [7], each time you press and hold the number "1" Preset button [9] for 2 seconds or longer, the reception area switches from inside the USA to outside the USA or from outside the USA to inside the USA.
 - * Any station preset memories are lost when the reception area is changed.

Listening to the radio

1. Press FNC button [3] and select the radio mode.
2. Press BND button [12] and select the radio band. Each time the button is pressed, the radio reception band changes in the following order:
FM1 → FM2 → FM3 → AM → FM1...
3. Press the right or left side of SEARCH button [14] to tune in the desired station.

Tuning

There are three types of tuning mode available, seek tuning, manual tuning and preset tuning.

Seek tuning

1. Press BND button [12] and select the desired band. (FM or AM)
 - * If "MANU" is illuminated in the display, press and hold BND button [12] for 1 second or longer. "MANU" in the display disappears and seek tuning is now available.
2. Press the right or left side of SEARCH button [14] to automatically seek a station. When the right side of SEARCH button [14] is pressed, the station is sought in the direction of higher frequencies; if the left side of SEARCH button [14] is pressed, the station is sought in the direction of lower frequencies.

Manual tuning

There are 2 ways available: Quick tuning and step tuning. When you are in the step tuning mode, the frequency changes one step at a time. In quick tuning mode, you can quickly tune the desired frequency.

1. Press BND button [12] and select the desired band. (FM or AM)

* If "MANU" is not illuminated in the display, press and hold BND button [12] for 1 second or longer. "MANU" is illuminated in the display and manual tuning is now available.

2. Tune into a station.

● Quick tuning:

Press and hold the right or left side of SEARCH button [14] for 1 second or longer to tune in a station.

● Step tuning:

Press the right or left side of SEARCH button [14] to manually tune in a station.

Recalling a preset station

A total of 24 preset positions (6-FM1, 6-FM2, 6-FM3, 6-AM) exist to store individual radio stations in memory. Pressing the corresponding preset button recalls the stored radio frequency automatically.

1. Press BND button [12] and select the desired band. (FM or AM)
2. Press the corresponding Preset button [9] to recall the stored station.

* Press and hold one of Preset buttons [9] for 2 seconds or longer to store that station into preset memory.

Manual memory

1. Select the desired station with seek tuning, manual tuning, or preset tuning.
2. Press and hold one of Preset buttons [9] for 2 seconds or longer to store the current station into preset memory.

Auto store

Auto store is a function for storing up to 6 stations that are automatically tuned in sequentially. If 6 receivable stations cannot be received, a previously stored station remains unoverwritten at the memory position.

1. Press BND button [12] and select the desired band. (FM or AM)
2. Press and hold AS button [5] for 2 seconds or longer. The stations with good reception are stored automatically to the preset buttons.

Preset scan

Preset scan receives the stations stored in preset memory in order. This function is useful when searching for desired station in memory.

1. Press PS button [5].
2. When the desired station is tuned in, press PS button [5] again to continue receiving that station.

Note:

- Be careful not to press and hold PS button [5] for 2 seconds or longer, otherwise the auto store function engages and the unit starts storing stations.

Instant station recall (ISR)

Instant station recall is a special radio preset that instantly accesses a favorite radio station at the touch of a button. The ISR function even operates with the unit in other modes.

● ISR memory

1. Select the station that you wish to store in ISR memory.
2. Press and hold ISR button [11] for 2 seconds or longer.

● Recalling a station with ISR

In any mode, pressing ISR button [11] illuminates "ISR" in the display, turns on the radio function, and tunes the selected radio station. Press ISR button [11] again to return to the previous mode.

Loading a CD

1. Press OPEN button [1] to access the CD insertion slot behind the FLIP DOWN PANEL.

⚠ CAUTION

Be careful not to catch your hand or fingers while closing the FLIP DOWN PANEL.

Note:

- If the FLIP DOWN PANEL does not open fully, gently open with your hand.
2. Insert a CD into the center of the insertion slot with the label side facing up. The CD plays automatically after loading.

Notes:

- Never insert foreign objects into the CD insertion slot.
- If the CD is not inserted easily, there may be another CD in the mechanism or the unit may require service.
- Discs not bearing the  mark and CD-ROMs cannot be played by this unit.

Loading 3" (8 cm) compact discs

- * No adapter is required to play a 3" CD.
 - * Insert the 3" CD into the center of the insertion slot.
 - * When a 3" CD is loaded, "SINGLE" illuminates in the display.
3. Close the FLIP DOWN PANEL.

Note:

- After loading a CD, always close the FLIP DOWN PANEL.

Listening to a CD already inserted

Press FNC button [3] to select the CD mode. Play starts automatically. If no CD is loaded in the unit, "NO DISC" appears in the display.

Pausing play

1. Press Play/pause button [2] to pause play. "PAUSE" appears in the display.
2. To resume CD play, press Play/pause button [2] again.

Displaying CD titles

This unit can display title data for CD-text CDs and user titles input with this unit.

1. Press DISP button [10] to display the title.
2. Each time you press and hold DISP button [10] for 1 second or longer, the title display changes in the following order:
User title (disc) → CD-text title (disc) → CD-text title (track) → user title (disc)...

Note:

- If the CD playing is not a CD-text CD or no user title has been input, "NO-TTL" is displayed.

● Scrolling a CD-text title

When a CD-text title is longer than 11 characters, you can scroll the display as follows.

1. Display the CD-text title. (disc or track)
2. Press TITLE button [4]. The title scrolls.

Ejecting a CD

1. Press OPEN button [1] to open the FLIP DOWN PANEL.

⚠ CAUTION

Be careful not to catch your hands or fingers while opening or closing the FLIP DOWN PANEL.

Note:

- If the FLIP DOWN PANEL does not open fully, gently open with your hand.

2. Press Eject button [17] to eject the CD. Take it out from the ejected position.
 - * "DISC CHECK" appears in the display when the CD is left in the ejected position.
3. Close the FLIP DOWN PANEL.

Note:

- After taking out the CD, be sure to close the FLIP DOWN PANEL.

* If a CD (12 cm) is left in the ejected position for 15 seconds, the CD is automatically reloaded. (Auto reload)

* 3" CDs (8 cm) are not auto reloaded. Be sure to remove it when ejected.

Notes:

- If you force a CD into before auto reloading, this can damage the CD.
- The radio mode is selected automatically 4 seconds after Eject button [17] is pressed. If the auto antenna terminal for this unit is connected, the antenna is extended automatically. If you are in a location where the antenna may strike something, press FNC button [3] to switch the mode.
- "DISC CHECK" in the display shows you a CD is left in the unit. Be sure to press Eject button [17] and remove it in this case.

Selecting a track**● Track-up**

1. Press the right side of SEARCH button [14] to move ahead to the beginning of the next track.
2. Each time you press the right side of SEARCH button [14], the track advances ahead to the beginning of the next track.

● Track-down

1. Press the left side of SEARCH button [14] to move back to the beginning of the current track.
2. Press the left side of SEARCH button [14] twice to move to the beginning of the previous track.

Fast-forward/fast-backward**● Fast-forward**

Press and hold the right side of SEARCH button [14] for 1 second or longer.

● Fast-backward

Press and hold the left side of SEARCH button [14] for 1 second or longer.

Top function

The top function resets the CD player to the first track of the disc. Press TOP button [12] to play the first track (track No. 1) on the disc.

Scan play

The scan play locates and plays the first 10 seconds of each track on a disc automatically. This function continues on the disc until it is canceled.

* The scan play is useful when you want to select a desired track.

1. Press SCN button [5] to start track scanning. "SCN" illuminates in the display.
2. To cancel the scan play, press SCN button [5] again. "SCN" disappears from the display and the current track continues to play.

Repeat play

The repeat play continuously plays the current track. This function continues automatically until it is canceled.

1. Press RPT button [6]. "RPT" illuminates in the display and the current track is repeated.
2. To cancel the repeat play, press RPT button [6] again. "RPT" disappears from the display and normal play resumes.

Random play

The random play selects and plays individual tracks on the disc in no particular order. This function continues automatically until it is canceled.

1. Press RDM button [7]. "RDM" illuminates in the display, an individual track is selected randomly and play begins.
2. To cancel the random play, press RDM button [7] again. "RDM" disappears and normal play resumes.

Other Handy Functions

Setting the clock

1. Press and hold ADJ button [4] for 1 second or longer to switch to the adjustment selection display.
2. Press the right or left side of SEARCH button [14] to select "CLOCK".
3. Press ENT button [2].
4. Press the right or left side of SEARCH button [14] to select the hour or the minute.
5. Turn the Rotary knob [15] clockwise or counterclockwise to set the correct time.
 - * The clock is displayed in 12-hour format.
6. Press ENT button [2] to store the time into memory.
7. Press ADJ button [4] to return to the previous mode.

Note:

- You cannot set the clock when it is displayed with only the ignition on. If you drain or remove the car's battery or take out this unit, the clock is reset. While setting the clock, if another button or operation is selected, the clock set mode is canceled.

Dimmer level setting

You can reduce the display illumination linked to the car illumination.

* The factory default setting is "LEVEL 3".

1. Press and hold ADJ button [13] for 1 seconds or longer to switch to the adjustment selection display.
2. Press the right or left side of SEARCH button [14] to select "DIMMER LV".
3. Press ENT button [2].
4. Turn the Rotary knob [15] clockwise or counterclockwise to set the dimmer level. Choose the dimmer level from the following. "OFF", "LEVEL 1", "LEVEL 2", "LEVEL 3", "LEVEL 4", "LEVEL 5"

LEVEL 1 to LEVEL 5:

The greater the dimmer level is, the more the illumination is reduced.

OFF:

If the car illumination is turned on, reduction of the display illumination does not occur.

5. Pressing ENT button [2] returns to the adjustment selection display.
6. Press ADJ button [13] to return to the previous mode.

Entering titles

Titles up to 10 characters long can be stored in memory and displayed for radio stations and CDs. The numbers of titles that can be entered for each mode are as follows.

Mode	Number of titles
Radio mode	30 titles
CD mode	50 titles
TV mode	15 titles

CD changer mode	Number of titles
CDC655z connected	60 titles
CDC655Tz connected	100 titles
CDC1255z connected	50 titles

1. Press FNC button [3] to select the mode you want to enter a title. (radio, CD, CD changer or TV)
 - * Titles cannot be entered for MDs with this unit.
2. Select and play a CD or a CD in the CD changer or tune to an appropriate TV or radio station.
3. Press DISP button [10] and display the subtitle.
4. Press TITLE button [4]. "TITL" appears in the display and the cursor position flashes.
5. Press the right or left side of SEARCH button [14] to move the cursor.
6. Press DISP button [10] to select the character. Each time you press DISP button [10], the character changes in the following order:
Capital letters → Small letters → Numbers → Symbols → Umlaut → Capital letters...
7. Turn the Rotary knob [15] to select the desired character. Turning the Rotary knob [15] clockwise moves the cursor to the next character; turning it counterclockwise moves the cursor to the previous character.
8. Repeat steps 5 to 7 to enter up to 10 characters for the title.
9. Press and hold ENT button [2] for 2 seconds or longer to store the title into memory and cancel title input mode.

Clearing titles

1. Play the CD or CD in the CD changer or tune the radio station or TV station that you want to clear the title for.
2. Press DISP button [10] and display the subtitle.
3. Press TITLE button [4]. "TITL" appears in the display and the display switches to title input display.
4. Press BND button [12].
5. Press and hold ENT button [2] for 2 seconds or longer to clear the title and cancel title input mode.

Adjusting the display contrast

You can adjust the display contrast according to the angle of installation of the unit.

- * The factory default setting is "6". (Adjustment level: 1 to 11)
- 1. Press and hold ADJ button [4] for 1 second or longer to switch to the adjustment selection display.
- 2. Press the right or left side of SEARCH button [14] to select "CONTRAST".
- 3. Press ENT button [2].
- 4. Turn the Rotary knob [15] clockwise or counterclockwise to adjust the contrast.
- 5. Pressing ENT button [2] returns to the adjustment selection display.
- 6. Press ADJ button [4] to return to the previous mode.

Setting the SEARCH button illumination color (Prism function)

The change in the SEARCH button illumination color according to the unit operating state is called the "Prism function". You can set the illumination pattern you prefer.

- * The factory default setting is "PATTERN 1".
- 1. Press and hold ADJ button [4] for 1 second or longer to switch to the adjustment selection display.
- 2. Press the right or left side of SEARCH button [14] to select "PRISM KEY".
- 3. Press ENT button [2].
- 4. Turn the Rotary knob [15] clockwise or counterclockwise to set the illumination pattern. Each time you turn the Rotary knob [15], the illumination pattern changes in the following order:

PATTERN 1 → PATTERN 2 → OFF → PATTERN 1...

PATTERN 1:

The color changes for each function mode, station tuning, scanning and other operations.

PATTERN 2:

In addition to the changes in Pattern 1, the color changes according to the audio level.

OFF:

The color changes according to the function mode.

- 5. Pressing ENT button [2] returns to the adjustment selection display.
- 6. Press ADJ button [4] to return to the previous mode.

Message display

When the unit is powered on or off, a message is displayed. The user can turn this message display on or off.

- * The factory default setting is "ON".

1. Press and hold ADJ button [4] for 1 second or longer to switch to the adjustment selection display.
2. Press the right or left side of SEARCH button [14] to select "MESSAGE".
3. Press ENT button [2].
4. Turn the Rotary knob [15] clockwise to set the message display to "ON"; turn it counterclockwise to set the message display to "OFF".
5. Pressing ENT button [2] returns to the adjustment selection display.
6. Press ADJ button [4] to return to the previous mode.

NON-FADER output adjustment display ON/OFF

If you do not want to adjust the non-fader output level, you can turn off the "NON-FAD VOL" display.

- * The factory default setting is "ON".
- * Even if you set the level adjustment display to "OFF", a signal is output from the non-fader output.

1. Press and hold ADJ button [4] for 1 second or longer to switch to the adjustment selection display.
2. Press the right or left side of SEARCH button [14] to select "NON-FADER".
3. Press ENT button [2].
4. Turn the Rotary knob [15] clockwise to set the non-fader output adjustment display to "ON"; turn it counterclockwise to set the non-fader output adjustment display to "OFF".

ON:

When A-M button [13] is pressed, the "NON-FAD VOL" item is displayed.

- * You can adjust the output level.

OFF:

Even when you press A-M button [13], the "NON-FAD VOL" item is not displayed.

- * You cannot adjust the output level.

5. Pressing ENT button [2] returns to the adjustment selection display.
6. Press ADJ button [4] to return to the previous mode.

Triggered audio mute for cellular telephones

This unit requires special wiring to mute the audio signal automatically when a cellular telephone rings in the car.

- * This function is not compatible with all cellular telephones. Contact your local authorized Clarion dealer for information on proper installation and compatibility.

8. OPERATIONS OF ACCESSORIES

CD Changer Operations

CD changer functions

When an optional CD changer is connected through the CeNET cable, this unit controls all CD changer functions. This unit can control a total of 2 changers (MD and/or CD).

Press FNC button [3] and select the CD changer mode to start play. If 2 CD changers are connected, press FNC button [3] to select the CD changer for play.

* If "NO MAGAZINE" appears in the display, insert the magazine into the CD changer. "DISC CHECK" appears in the display while the player loads (checks) the magazine.

* If "NO DISC" appears in the display, eject the magazine and insert discs into each slot. Then, reinsert the magazine back into the CD changer.

⚠ CAUTION

CD-ROM discs cannot be played in the CD changer.

Pausing play

1. Press Play/pause button [2] to pause play. "PAUSE" appears in the display.
2. To resume play, press Play/pause button [2] again.

Displaying CD titles

This unit can display title data for CD-text CDs and user titles input with this unit.

1. Press DISP button [10] to display the title.
2. Each time you press and hold DISP button [10] for 1 second or longer, the title display changes in the following order:

User title (disc) → CD-text title (disc) → CD-text title (track) → user title (disc)...

Note:

• If the CD playing is not a CD-text CD or no user title has been input, "NO-TTL" is displayed.

● Scrolling a CD-text title

When a CD-text title is longer than 11 characters, you can scroll the display as follows.

1. Display the CD-text title (disc or track).
2. Press TITLE button [4]. The title scrolls.

Selecting a CD

Each Direct button [9] corresponds to a disc loaded into the magazine.

● Selecting a disc from 1 to 6

Press the corresponding Direct button (1 to 6) [9] to select the desired disc.

● Selecting a disc from 7 to 12 (only when a 12 disc CD changer is used.)

Press and hold Direct button (7 to 12) [9] for 1 second or longer to select the desired disc.

* If a CD is not loaded in a magazine, pressing Direct button [9] corresponding to its disc number is invalid.

Selecting a track

● Track-up

1. Press the right side of SEARCH button [14] to move ahead to the beginning of the next track.
2. Each time you press the right side of SEARCH button [14], the track advances ahead to the beginning of the next track.

● Track-down

1. Press the left side of SEARCH button [14] to move back to the beginning of the current track.
2. Press the left side of SEARCH button [14] twice to move to the beginning of the previous track.

Fast-forward/fast-backward

● Fast-forward

Press and hold the right side of SEARCH button [14] for 1 second or longer.

● Fast-backward

Press and hold the left side of SEARCH button [14] for 1 second or longer.

Top function

The top function plays from the first track (track No. 1) of the disc.

● When playing a disc 1 to 6

Press Direct button (1 to 6) [9] with the same number as the CD playing.

● When playing a disc 7 to 12 (only when a 12 disc CD changer is used.)

Press and hold for 1 second or longer Direct button (7 to 12) [9] with the same number as the CD playing.

* If a CD is not loaded in a magazine, pressing Direct button [9] corresponding to its disc number is invalid.

Scan play

The scan play locates and plays the first 10 seconds of each track on a disc automatically. This function continues on the disc until it is canceled.

* The scan play is useful when you want to select a desired track.

1. Press SCN button [5] to start track scanning. "SCN" illuminates in the display.
2. To cancel the scan play, press SCN button [5] again. "SCN" disappears from the display and the current track continues to play.

Disc scan play

The disc scan play locates and plays the first 10 seconds of the first track on each disc in the currently selected CD changer. This function continues automatically until it is canceled.

* The disc scan play is useful when you want to select a desired CD.

1. Press and hold SCN button [5] for 1 second or longer. "DISC" and "SCN" illuminate in the display and the disc scan play starts.
2. To cancel the disc scan play, press SCN button [5] again. "DISC" and "SCN" disappear from the display and the current track continues to play.

Repeat play

The repeat play continuously plays the current track. This function continues automatically until it is canceled.

1. Press RPT button [6]. "RPT" illuminates in the display and the current track is repeated.
2. To cancel the repeat play, press RPT button [6] again. "RPT" disappears from the display and normal play resumes.

Disc repeat play

After all the tracks in the current disc have been played, the disc repeat play automatically replays the current disc over from the first track. This function continues automatically until it is canceled.

1. Press and hold RPT button [6] for 1 second or longer. "DISC" and "RPT" illuminate in the display and the disc repeat play starts.
2. To cancel the disc repeat play, press and hold RPT button [6] again. "DISC" and "RPT" disappear from the display and normal play resumes on the current track.

Random play

The random play selects and plays individual tracks on the disc in no particular order. This function continues automatically until it is canceled.

1. Press RDM button [7]. "RDM" illuminates in the display and the random play begins.
2. To cancel the random play, press RDM button [7] again. "RDM" disappears and normal play resumes.

Disc random play

The disc random play selects and plays individual tracks or discs automatically in no particular order. This function continues automatically until it is canceled.

1. Press and hold RDM button [7] for 1 second or longer. "DISC" and "RDM" illuminate in the display and the disc random play starts.
2. To cancel the disc random play, press and hold RDM button [7] again. "DISC" and "RDM" disappear from the display and normal play resumes from the current track.

MD Changer Operations

MD changer functions

When an optional MD changer is connected through the CeNET cable, this unit controls all MD changer functions. This unit can control a total of 2 changers (MD and/or CD).

Press FNC button [3] and select the MD changer mode to start play. If 2 MD changers are connected, press FNC button [3] to select the MD changer for play.

* If "NO DISC" appears in the display, load MDs into the MD changer.

Pausing play

1. Press Play/pause button [2] to pause play. "PAUSE" appears in the display.
2. To resume play, press Play/pause button [2] again.

Switching disc titles and track titles

This unit can display disc titles and track titles already entered on MDs. Titles up to 128 characters long can be displayed by scrolling the titles.

* Titles cannot be entered for MDs with this unit.

1. Press DISP button [10] to display the title. The disc title or track title is displayed.
2. Each time you press and hold DISP button [10] for 1 second or longer, the display toggles between the disc title and the track title.

● Scrolling titles

When a title is longer than 11 characters, you can scroll through it with the following operation.

1. Display the MD title (disc or track).
2. Press TITLE button [4].

The display scrolls through the title.

Selecting an MD

Each Direct button [9] corresponds to a MD loaded into the MD changer. Press the corresponding Direct button (1 to 6) [9] to select the desired disc.

* If a MD is not loaded in the MD changer, pressing Direct button [9] corresponding to its disc number is invalid.

Selecting a track

● Track-up

1. Press the right side of SEARCH button [14] to move ahead to the beginning of the next track.

2. Each time you press the right side of SEARCH button [14], the track advances ahead to the beginning of the next track.

● Track-down

1. Press the left side of SEARCH button [14] to move back to the beginning of the current track.
2. Press the left side of SEARCH button [14] twice to move to the beginning of the previous track.

Fast-forward/fast-backward

● Fast-forward

Press and hold the right side of SEARCH button [14] for 1 second or longer.

● Fast-backward

Press and hold the left side of SEARCH button [14] for 1 second or longer.

Top function

The top function plays from the first track (track No. 1) of the disc. Press Direct button (1 to 6) [9] with the same number as the MD playing.

* If a MD is not loaded in the MD changer, pressing Direct button [9] corresponding to its disc number is invalid.

Scan play

The scan play locates and plays the first 10 seconds of each track on a disc automatically. This function continues on the disc until it is canceled.

* The scan play is useful when you want to select a desired track.

1. Press SCN button [5] to start track scanning. "SCN" illuminates in the display.
2. To cancel the scan play, press SCN button [5] again. "SCN" disappears from the display and the current track continues to play.

Disc scan play

The disc scan play locates and plays the first 10 seconds of the first track on each disc in the currently selected MD changer. This function continues automatically until it is canceled.

* The disc scan play is useful when you want to select a desired MD.

1. Press and hold SCN button [5] for 1 second or longer. "DISC" and "SCN" illuminate in the display and the disc scan play starts.
2. To cancel the disc scan play, press and hold SCN button [5] again. "DISC" and "SCN" disappear from the display and the current track continues to play.

Repeat play

The repeat play continuously plays the current track. This function continues automatically until it is canceled.

1. Press RPT button [6]. "RPT" illuminates in the display and the current track is repeated.
2. To cancel the repeat play, press RPT button [6] again. "RPT" disappears from the display and normal play resumes.

Disc repeat play

After all the tracks on the current disc have been played, the disc repeat play automatically replays the current disc over from the first track. This function continues automatically until it is canceled.

1. Press and hold RPT button [6] for 1 second or longer. "DISC" and "RPT" illuminate in the display and the disc repeat play starts.
2. To cancel the disc repeat play, press and hold RPT button [6] again. "DISC" and "RPT" disappear from the display and normal play resumes on the current track.

Random play

The random play selects and plays individual tracks on the disc in no particular order. This function continues automatically until it is canceled.

1. Press RDM button [7]. "RDM" illuminates in the display and the random play begins.
2. To cancel the random play, press RDM button [7] again. "RDM" disappears from the display and normal play resumes.

Disc random play

The disc random play selects and plays individual tracks or discs automatically in no particular order. This function continues automatically until it is canceled.

1. Press and hold RDM button [7] for 1 second or longer. "DISC" and "RDM" illuminates in the display and the disc random play starts.
2. To cancel the disc random play, press and hold RDM button [7] again. "DISC" and "RDM" disappear from the display and normal play resumes from the current track.

TV tuner functions

When an optional TV tuner is connected through the CeNET cable, this unit controls all TV tuner functions. To watch TV requires a TV tuner and monitor.

Watching a TV

1. Press FNC button [3] and select the TV mode.
2. Press BND button [12] to select the desired TV band (TV1 or TV2). Each time the button is pressed, the input selection toggles between TV1 and TV2.
3. Press the right or left side of SEARCH button [14] to tune in the desired TV station.

Watching a video

The TV tuner has a VTR input terminal to which 1 external device can be connected. Connect a 12V video cassette player (VCP) or video cassette recorder (VCR) to the TV tuner input terminal.

1. Press RDM button [7] to select VTR.
2. To return to the TV broadcast, press RDM button [7].

Tuning

There are three types of tuning mode available, Seek tuning, manual tuning and preset tuning.

Seek tuning

1. Press BND button [12] and select the desired TV band (TV1 or TV2).
 - * If "MANU" is illuminated on the display, press and hold BND button [12] for 1 second or longer. "MANU" in the display disappears and seek tuning is now available.
2. Press the right or left side of SEARCH button [14] to automatically seek a station. Press the right side of SEARCH button [14] to automatically tune up the frequency band to the next available TV station; press the left side to automatically tune down.

TV Operations

Manual tuning

There are 2 ways available: Quick tuning and step tuning. When you are in the step tuning mode, the frequency changes one step at a time. In quick tuning mode, you can quickly tune the desired frequency.

1. Press BND button **[12]** and select the desired band. (TV1 or TV2)

* If "MANU" is not illuminated in the display, press and hold BND button **[12]** for 1 second or longer. "MANU" is illuminated in the display and manual tuning is now available.

2. Tune into a station.

● Quick tuning:

Press and hold the right or left side of SEARCH button **[14]** for 1 second or longer to tune in a station.

● Step tuning:

Press the right or left side of SEARCH button **[14]** to manually tune in a station.

Recalling a preset station

A total of 12 TV stations can be stored (6-TV1 and 6-TV2). This allows you to select your favorite TV stations and store them in memory for later recall.

1. Press BND button **[12]** and select the desired TV band. (TV1 or TV2)
2. To recall a stored TV station, press the desired Preset button **[9]** to select that station.

* Press and hold one of Preset buttons **[9]** for 2 seconds or longer to store the current station into the preset memory.

Manual memory

1. Select the desired station with seek tuning, manual tuning or preset tuning.
2. Press and hold one of Preset buttons **[9]** for 2 seconds or longer to store the current station to that preset memory.

Auto store

Auto store selects 6 TV stations automatically and stores each one into a preset memory.

If there are not 6 stations with good reception, stations previously stored in memory remain and only the strong stations are stored into memory.

1. Press BND button **[12]** and select the desired TV band. (TV1 or TV2)
2. Press and hold AS button **[5]** for 2 seconds or longer. The stations with good reception are automatically stored to preset buttons.

Preset scan

Preset scan allows the user to view each preset position before it automatically advances to the next preset. This function is useful for searching for desired TV station in memory.

1. Press PS button **[5]**.
2. When the desired station is found, press PS button **[5]** again to remain tuned to that station.

Note:

* Do not press and hold PS button **[5]** for 2 seconds or longer. Doing so will trigger the auto store function and start storing stations into memory.

DSP control function

If the DSP (DPH7500z), sold separately, is connected to this unit using the CeNet cable, all functions of the DSP can be controlled.

DSP functions

There are 2 modes available in DPH7500z, easy mode and professional mode. Choose one of them and adjust the sound field and the sound quality.

• Functions common to each mode:

Spectrum analyzer display, auto loudness, etc.

• Easy mode:

Adjustment using the graphic equalizer function and the DSP function.

• Professional mode:

Adjustment using the space equalizer function and the parametric equalizer function

* When the easy mode is selected, adjustment for the professional mode cannot be made. On the contrary, when the professional mode is selected, adjustment for the easy mode cannot be made.

* For details on functions of each mode, refer to the owner's manual supplied with the DPH7500z.

* Hereafter the graphic equalizer is referred to as a G.EQ., the space equalizer referred to as S.EQ. and the parametric equalizer referred to as P.EQ.

Operations common to each mode

Enjoying the spectrum analyzer

This unit can display the spectrum analyzer patterns. There are 8 spectrum analyzer patterns.

1. Press DISP button [10] to select the spectrum analyzer display.
2. Each time you press and hold DISP button [10] for 1 second or longer, the spectrum analyzer patterns are switched.

Setting the sensitivity of the spectrum analyzer

* The factory default setting is "MID".

1. Press and hold ADJ button [4] for 1 second or longer to switch to the adjustment selection display.
2. Press the right or left side of SEARCH button [14] to select "ANA SENS".
3. Press ENT button [2].

4. Turn the Rotary knob [15] clockwise or counterclockwise to set the sensitivity of the spectrum analyzer.

You can choose one of "LOW", "MID-LOW", "MID", "MID-HIGH" or "HIGH" for the sensitivity of the spectrum analyzer.

5. Pressing ENT button [2] returns to the adjustment selection display.
6. Press ADJ button [4] to return to the previous mode.

Output adjustment of auto loudness, subwoofer and playback band

1. Press and hold ADJ button [4] for 1 second or longer to switch to the adjustment selection display.
2. Press the right or left side of SEARCH button [14] to select "SOUND".
3. Press ENT button [2].
4. Press the right or left side of SEARCH button [14] to select the adjustment item.

There are "A.LD LEVEL", "WOOFER OUT", "WOOFER LPF", "HPF" and "TEST TONE" available for the adjustment items.

* For details on each adjustment item, refer to the owner's manual supplied with the DPH7500z.

5. Turn the Rotary knob [15] clockwise or counterclockwise to make the adjustment.
6. Pressing ENT button [2] returns to the adjustment selection display.
7. Press ADJ button [4] to return to the previous mode.

Selecting the easy mode or the professional mode

* The factory default setting is "EASY".

1. Press and hold ADJ button [4] for 1 second or longer to switch to the adjustment selection display.
2. Press the right or left side of SEARCH button [14] to select "DSP/EQ SEL".
3. Press ENT button [2].
4. Turn the Rotary knob [15] clockwise or counterclockwise to set the mode to "EASY" or "PRO".
5. Pressing ENT button [2] returns to the adjustment selection display.
6. Press ADJ button [4] to return to the previous mode.

Inputting a title

You can give a title to the user memory of the DSP, G.EQ, S.EQ and P.EQ that you have adjusted yourself.

1. Press A-M button [13] to select the adjustment mode in which you want to give a title.
2. Press BND button [12] to select "USER". "USER" will be displayed in the function mode indication [12].
3. Press one of Preset buttons [9] to select the user memory to which you want to give a title.
4. Press TITLE button [4].
5. Press the right or left side of SEARCH button [14] to move the cursor.
6. Press DISP button [10] to select the character fonts.
There are capital letters, small letters, numbers, symbols and umlaut available for the character.
7. Turn the Rotary knob [15] clockwise or counterclockwise to select the character you want to input.
8. Repeat steps 5 to 7 to input the title.
9. Press and hold ENT button [2] for 2 seconds or longer to put the title into memory. The title input mode is canceled.

Easy mode/G.EQ operations

Note:

• The adjustment made in easy mode is not reflected in the adjustment in professional mode. On the contrary, the adjustment made in professional mode is not reflected in the adjustment in easy mode.

G.EQ effect ON/OFF

While the "G.EQ" indication [4] is lit in the display, the G.EQ effect is set to "ON".

* The factory default setting is "ON".

1. Press A-M button [13] and select "G.EQ". While "G.EQ" is selected, "G.EQ" blinks in the display.
2. Press DISP button [10].
3. Press A-M button [13]. "G.EQ" in the display is changed to blinking to lit or unlit.
* When "G.EQ" is unlit, the G.EQ effect is set to OFF.

Note:

• If the G.EQ effect is set to OFF, the adjustment made in "G.EQ operations" is not reflected in the music source.

Selecting a G.EQ menu

1. Press A-M button [13] and select "G.EQ". "G.EQ" blinks in the display.
2. Press BND button [12] to select "BASIC". "BASIC" is displayed in the function mode indication [12] in the display.
3. Press one of Direct buttons [9] and select the desired G.EQ menu.
* To select the user memory, press BND button [12] to select "USER" and press one of Direct buttons [9].

Editing/storing a G.EQ menu (User memory)

1. Select a G.EQ menu which you want to edit on the basis of.
2. Press and hold ADJ button [4] for 1 second or longer.
3. Press the right or left side of SEARCH button [14] to select the frequency to be adjusted. There are 50Hz, 100Hz, 200Hz, 400Hz, 1kHz, 3kHz and 12kHz available for the adjustment frequency.
* For details on each adjustment item, refer to the owner's manual supplied with the DPH7500z.
4. Turn the Rotary knob [15] clockwise or counterclockwise to make the adjustment. The adjustment range is from -12dB to +12dB.
5. Repeat steps 3 to 4 to complete the adjustment and press ADJ button [4].
6. Press and hold one of Direct buttons [9] for 2 seconds or longer to store the edited contents.
* You can give a title to the user memory. For the inputting method of titles, refer to the subsection "Inputting a title" in "Operations common to each mode".

Easy mode/DSP operations

DSP effect ON/OFF

When the "DSP" indication [5] is lit in the display, the DSP effect is set to "ON".

* The factory default setting is "ON".

1. Press A-M button [13] and select "DSP". While "DSP" is selected, "DSP" blinks in the display.
2. Press DISP button [10].
3. Press A-M button [13]. "DSP" in the display is changed to blinking to lit or unlit.
* When "DSP" is unlit, the DSP effect is set to OFF.

Note:

• If the DSP effect is set to OFF, the adjustment made in "DSP operations" is not reflected in the music source.

Setting the listening position menu

1. Press A-M button [13] and select "DSP". "DSP" blinks in the display.
2. Press the right or left side of SEARCH button [14] to set the listening position type.
There are FULL SEAT, FRONT-R (only right seat), FRONT-L (only left seat), FRONT (only front seats), REAR (only rear seats) and PASS available for the listening position types.
* The factory default setting is "FULL SEAT".

Making fine adjustment of the listening position

1. Upon completion of setting the listening position, press ENT button [2].
2. Press the right or left side of SEARCH button [14] to select "BAL" or "FAD". The selected item blinks.
3. Turn the Rotary knob [15] clockwise or counterclockwise to adjust the balance and the fader.
4. Press ENT button [2] to return to the DSP mode.

Selecting a sound field menu

1. Press A-M button [13] and select "DSP". "DSP" blinks in the display.
2. Press BND button [12] to select "BASIC 1" or "BASIC 2". "BASIC 1" or "BASIC 2" is displayed in the function mode indication [12] in the display.
3. Press one of Direct buttons [9] and select the desired sound field menu.
* To select the user memory, press BND button [12] to select "USER" and press one of Direct buttons [9].

Editing/storing a sound field menu

1. Select a sound field menu which you want to edit on the basis of.
2. Press and hold ADJ button [4] for 1 second or longer.
3. Press the right or left side of SEARCH button [14] to select the item to be adjusted.
There are EFFECT LEVEL, INITIAL DELAY, REAR MIX, REVERB TIME or ROOM SIZE and HIGH or LIVENESS available for the items to be adjusted.
* For details on each adjustment item, refer to the owner's manual supplied with the DPH7500z.

4. Turn the Rotary knob [15] clockwise or counterclockwise to make the adjustment.
5. Repeat steps 3 to 4 to complete the adjustment and press ADJ button [4].
6. Press and hold one of Direct buttons [9] for 2 seconds or longer to store the edited contents.
* You can give a title to the user memory. For the inputting method of titles, refer to the subsection "Inputting a title" in "Operations common to each mode".

Professional mode/S.EQ operations

Note:

- The adjustment made in professional mode is not reflected in the adjustment in easy mode. On the contrary, the adjustment made in easy mode is not reflected in the adjustment in professional mode.

S.EQ effect ON/OFF

While the "S.EQ" indication [8] is lit in the display, the S.EQ effect is set to "ON".

* The factory default setting is "ON".

1. Press A-M button [13] and select "S.EQ". While "S.EQ" is selected, "S.EQ" blinks in the display.
2. Press DISP button [10].
3. Press A-M button [13]. "S.EQ" in the display is changed to blinking to lit or unlit.
* When "S.EQ" is unlit, the S.EQ effect is set to OFF.

Note:

- If the S.EQ effect is set to OFF, the adjustment made in "S.EQ operations" is not reflected in the music source.

Selecting a S.EQ menu

1. Press A-M button [13] and select "S.EQ". "S.EQ" blinks in the display.
2. Press BND button [12] to select "BASIC". "BASIC" is displayed in the function mode indication [12] in the display.
3. Press one of Direct buttons [9] and select the desired S.EQ menu.
* To select the user memory, press BND button [12] to select "USER" and press one of Direct buttons [9].

Editing/storing a S.EQ menu (User memory)

1. Select a S.EQ menu which you want to edit on the basis of.
2. Press and hold ADJ button [4] for 1 second or longer.
3. Press the right or left side of SEARCH button [14] to select the item to be adjusted.

There are DIFFUZE, CAR WIDTH and CAR LENGTH available for the items to be adjusted.

- * For details on each adjustment item, refer to the owner's manual supplied with the DPH7500z.
4. Turn the Rotary knob [15] clockwise or counterclockwise to make the adjustment. The adjustment range is from 1 to 10 for each item.
 5. Repeat steps 3 to 4 to complete the adjustment and press ADJ button [4].
 6. Press and hold one of Direct buttons [9] for 2 seconds or longer to store the edited contents.
 - * You can give a title to the user memory. For the inputting method of titles, refer to the subsection "Inputting a title" in "Operations common to each mode".

Editing/storing a P.EQ menu (User memory)

1. Select a P.EQ menu which you want to edit on the basis of.
2. Press and hold ADJ button [4] for 1 second or longer.
3. Press the right or left side of SEARCH button [14] to select the item to be adjusted.

There are correction channel, correction band, selection of the center frequency, gain adjustment and selection of the Q-curve available for the items to be adjusted.

- * For details on each adjustment item, refer to the owner's manual supplied with the DPH7500z.
4. Turn the Rotary knob [15] clockwise or counterclockwise to make the adjustment.
 5. Repeat steps 3 to 4 to complete the adjustment and press ADJ button [4].
 6. Press and hold one of Direct buttons [9] for 2 seconds or longer to store the edited contents.
 - * You can give a title to the user memory. For the inputting method of titles, refer to the subsection "Inputting a title" in "Operations common to each mode".

Professional mode/P.EQ operations

P.EQ effect ON/OFF

While the "P.EQ" indication [7] is lit in the display, the P.EQ effect is set to "ON".

* The factory default setting is "ON".

1. Press A-M button [13] and select "P.EQ". While "P.EQ" is selected, "P.EQ" blinks in the display.
2. Press DISP button [10].
3. Press A-M button [13]. "P.EQ" in the display is changed to blinking to lit or unlit.
 - * When "P.EQ" is unlit, the P.EQ effect is set to OFF.

Note:

• If the P.EQ effect is set to OFF, the adjustment made in "P.EQ operations" is not reflected in the music source.

Selecting a P.EQ menu

1. Press A-M button [13] and select "P.EQ". "P.EQ" blinks in the display.
2. Press BND button [12] to select "BASIC". "BASIC" is displayed in the function mode indication [12] in the display.
3. Press one of Direct buttons [9] and select the desired P.EQ menu.
 - * To select the user memory, press BND button [12] to select "USER" and press one of Direct buttons [9].

9. TROUBLESHOOTING

	Problem	Cause	Measure
General	Power does not turn on. (No sound is produced.)	Fuse is blown.	Replace with a fuse of the same amperage. If the fuse blows again, consult your store of purchase.
		Incorrect wiring.	Consult your store of purchase.
	No sound output when operating the unit with amplifiers or power antenna attached.	Power antenna lead is shorted to ground or excessive current is required for remote-on the amplifiers or power antenna.	<ol style="list-style-type: none"> 1. Turn the unit off. 2. Remove all wires attached to the power antenna lead. Check each wire for a possible short to ground using an ohm meter. 3. Turn the unit back on. 4. Reconnect each amplifier remote wire to the power antenna lead one by one. If the amplifiers turn off before all wires are attached, use an external relay to provide remote-on voltage (excessive current required).
		Nothing happens when buttons are pressed. Display is not accurate.	The microprocessor has malfunctioned due to noise, etc.
	DCP or source unit connectors are dirty.	Wipe the dirt off with a soft cloth moistened with cleaning alcohol.	
CD	Compact disc cannot be loaded.	Another compact disc is already loaded.	Eject the compact disc before loading the new one.
	Sound skips or is noisy.	Compact disc is dirty.	Clean the compact disc with a soft cloth.
		Compact disc is heavily scratched or warped.	Replace with a compact disc with no scratches.
Sound is bad directly after power is turned on.	Water droplets may form on the internal lens when the car is parked in a humid place.	Let dry for about 1 hour with the power on.	

10. ERROR DISPLAYS

If an error occurs, one of the following displays is displayed.
Take the measures described below to eliminate the problem.

	Error Display	Cause	Measure
CD	ERROR 2	A CD is caught inside the CD deck and is not ejected.	This is a failure of CD deck's mechanism and consult your store of purchase.
	ERROR 3	A CD cannot be played due to scratches, etc.	Replace with a non-scratched, non-warped-disc.
	ERROR 6	A CD is loaded upside-down inside the CD deck and does not play.	Eject the disc then reload it properly.
CD changer	ERROR 2	A CD inside the CD changer is not loaded.	This is a failure of CD changer's mechanism and consult your store of purchase.
	ERROR 3	A CD inside the CD changer cannot be played due to scratches, etc.	Replace with a non-scratched, non-warped-disc.
	ERROR 6	A CD inside the CD changer cannot be played because it is loaded upside-down.	Eject the disc then reload it properly.
MD changer	ERROR H	Displayed when the temperature in the MD changer is too high and playback has been stopped automatically.	Lower the surrounding temperature and wait for a while to cool off MD changer.
	ERROR 2	A MD inside the MD changer is not loaded.	This is a failure of MD changer's mechanism and consult your store of purchase.
	ERROR 3	A MD inside the MD changer cannot be played due to scratches, etc.	Replace with a non-scratched, non-warped-disc.
	ERROR 6	A MD inside the MD changer cannot be played because it is loaded upside-down.	Eject the disc then reload it properly.
Displayed when a non-recorded MD is loaded in the MD changer.		Load a pre-recorded MD in the MD changer.	

If an error display other than the ones described above appears, press the reset button. If the problem persists, turn off the power and consult your store of purchase.

11. SPECIFICATIONS

FM Tuner

Frequency Range:

87.9 MHz to 107.9 MHz

Usable Sensitivity:

11 dBf

50dB Quieting Sensitivity:

17 dBf

Alternate Channel Selectivity:

75 dB

Stereo Separation (1 kHz):

35 dB

Frequency Response (± 3 dB):

30 Hz to 15 kHz

AM Tuner

Frequency Range:

530 kHz to 1710 kHz

Usable Sensitivity:

25 μ V

CD Player

System:

Compact disc digital audio system

Usable Discs:

Compact disc

Frequency Response (± 1 dB):

5 Hz to 20 kHz

Signal to Noise Ratio (1 kHz):

100 dB

Dynamic Range (1 kHz):

95 dB

Harmonic Distortion:

0.01%

Notes:

- Specifications comply with EIA Standards.
- Specifications and design are subject to change without notice for further improvement.

Audio

Maximum Power Output:

180 W (45 W \times 4 ch) (EIAJ)

Continuous Average Power Output:

17 W \times 4, into 4 Ω , 20 Hz to 20 kHz, 1%THD

Bass Control Action (30 Hz):

± 15 dB

Treble Control Action (10 kHz):

± 10 dB

Line Output Level (CD 1 kHz):

4 V

General

Power Supply Voltage:

14.4 V DC (10.8 to 15.6 V allowable),
negative ground

Current Consumption:

Less than 15 A

Speaker Impedance:

4 Ω (4 Ω to 8 Ω allowable)

Weight / Source unit:

3.75 lb. (1.7 kg)

Weight / Remote control unit:

1 oz. (30 g) (including battery)

Dimensions / Source unit:

7" (Width) \times 2" (Height) \times 6-1/8" (Depth)
[178 (W) \times 50 (H) \times 155 (D) mm]

Dimensions / Remote control unit:

1-3/4" (Width) \times 4-5/16" (Height) \times 1-1/8" (Depth)
[44 (W) \times 110 (H) \times 27 (D) mm]



Free Manuals Download Website

<http://myh66.com>

<http://usermanuals.us>

<http://www.somanuals.com>

<http://www.4manuals.cc>

<http://www.manual-lib.com>

<http://www.404manual.com>

<http://www.luxmanual.com>

<http://aubethermostatmanual.com>

Golf course search by state

<http://golfingnear.com>

Email search by domain

<http://emailbydomain.com>

Auto manuals search

<http://auto.somanuals.com>

TV manuals search

<http://tv.somanuals.com>