

clarion®

Owner's manual

使用说明书

사용 설명서

DXZ366MP

CD/MP3/WMA RECEIVER/CeNET CONTROL

CD/MP3/WMA 接收器/CeNET 控制

CD/MP3/WMA 리시버/CeNET 컨트롤

Contents

| | |
|---|----|
| 1. FEATURES | 2 |
| 2. CONTROLS | 3 |
| MAIN UNIT | 3 |
| 3. BUTTON TERMINOLOGY | 4 |
| Names of the Buttons and their Functions | 4 |
| Major Button Operations when external equipment is connected to this unit | 5 |
| 4. PRECAUTIONS | 6 |
| 5. HANDLING COMPACT DISCS | 7 |
| 6. DCP (Detachable Control Panel) | 8 |
| 7. REMOTE CONTROL | 9 |
| Inserting the Battery | 9 |
| Functions of Remote Control Unit Buttons | 10 |
| 8. OPERATIONS | 11 |
| Basic Operations | 11 |
| Radio Mode Operations | 13 |
| CD/MP3/WMA Mode Operations | 14 |
| Operations Common to Each Mode | 19 |
| 9. OPERATIONS OF ACCESSORIES | 22 |
| CD Changer Operations | 22 |
| TV Operations | 23 |
| 10. TROUBLESHOOTING | 25 |
| 11. ERROR DISPLAYS | 27 |
| 12. SPECIFICATIONS | 28 |

1. FEATURES

- Flip-down console
- MP3 and WMA compatible with ID3-TAG display
- “Z-ENHANCER” sound customization & “MAGNA BASS EX” dynamic bass enhancement



2. CONTROLS / 控制 / 제어부

MAIN UNIT / 主机 / 메인유닛

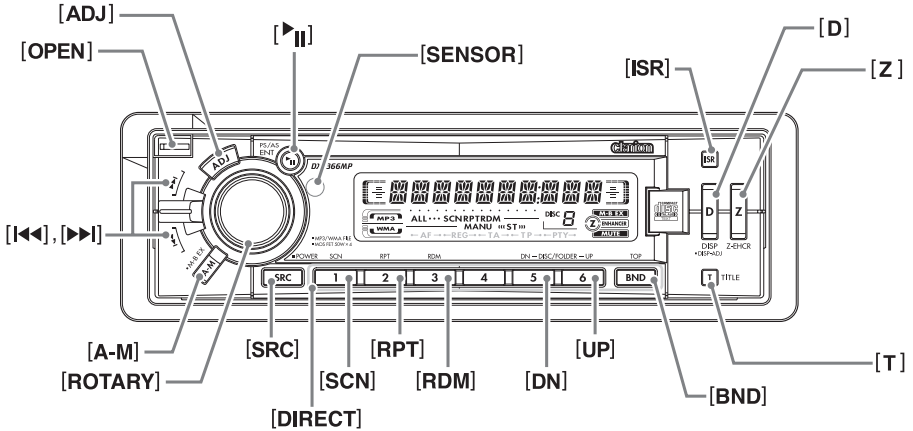

With the FLIP DOWN PANEL opened / 当 FLIP DOWN PANEL (翻开面板) 被打开时 / 플립다운 패널이 열린 상태

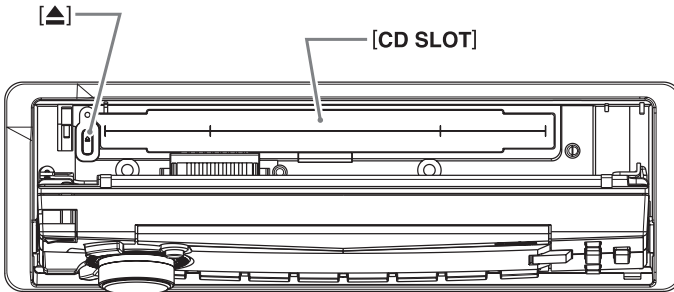

Note: Be sure to unfold this page and refer to the front diagrams as you read each chapter.

注意: 阅读各章时请务必展开此页并阅读前面的图。

주: 반드시 이 페이지를 펴서 각 장을 읽을 때 앞면 도표를 참고하십시오.

3. BUTTON TERMINOLOGY

Note:

- Be sure to read this chapter referring to the front diagrams of chapter "2. CONTROLS" on page 3.

Names of the Buttons and their Functions

[OPEN] button

- Deeply push in [OPEN] button to unlock the flip down panel.

[ADJ] button

- Press the button to switch to the ADJ mode.

[▶||] button

- Perform preset scan while in the radio mode. Press and hold the button for 2 seconds or longer to perform auto store.
- Play or pause a CD while in the CD/MP3/WMA mode.

[SENSOR]

- Receiver for remote control unit.
- Operating range: 30° in all directions.

[ISR] button

- Recall ISR radio station in memory.
- Press and hold for 2 seconds or longer: Store current station into ISR memory (radio mode only).

[D] button

- Switch the display indication (Main display, Title display, Clock display).
- Press and hold the button for 1 second or longer to enter the display adjustment mode.

[Z] button

- Press the button to select one of the 3 types of sound characteristics already stored in memory.

[T] button

- Press the button to input a title in the Radio mode.
- Press the button to input a title in the CD mode.
- Press the button to switch the user titles or track titles, while in the CD/MP3/WMA mode.
- Press the button to scroll the title during the CD-text play, while in the CD/MP3/WMA mode.

[BND] button

- Switch the band, or seek tuning or manual tuning while in the radio mode.
- Play a first track while in the CD/MP3/WMA mode. Press and hold the button for 1 second or longer to perform multi-session.
- Press the button to change the character.

[UP], [DN] buttons

- Select the Folder. (MP3/WMA disc only)

[RDM] button

- Perform random play while in the CD/MP3/WMA mode.
- Press and hold the button for 1 second or longer to perform folder random play while in the MP3/WMA mode.

[RPT] button

- Repeat play while in the CD/MP3/WMA mode.
- Press and hold the button for 1 second or longer to perform folder repeat play while in the MP3/WMA mode.

[SCN] button

- Perform scan play for 10 seconds of each track while in the CD/MP3/WMA mode.
- Press and hold the button for 1 second or longer to perform folder scan play while in the MP3/WMA mode.

[DIRECT] buttons

- Store a station into memory or recall it directly while in the radio mode.

[SRC] button

- Press the button to turn on the power.
- Press and hold the button for 1 second or longer to turn off the power.
- Switch the operation mode among the radio mode, etc.

[ROTARY] knob

- Adjust the volume by turning the knob clockwise or counterclockwise.
- Use the knob to perform various settings.

Names of the Buttons and their Functions

[A-M] button

- Press the button to switch to the audio mode. (bass/treble, balance/fader)
- Press and hold for 1 second or longer to turn on or off the M-B EX mode.

[▲] button

- Eject a CD when it is loaded into the unit.

[CD SLOT]

- CD insertion slot.

[◀◀, ▶▶] lever

- Select a station while in the radio mode or select a track when listening to a CD. This lever is used to make various settings.
- Press the lever upward or downward and hold in position for 1 second or longer to enter the fast-forward or fast-backward mode.

Major Button Operations when external equipment is connected to this unit

When the CD/DVD changer is connected

- * For details, see the section “**CD changer operations**”. For the DVD changer, refer to the Owner’s Manual provided with the DVD changer.

[▶||] button

- Play or pause a CD or DVD.

[D] button

- Press the button to display the title.
- Press and hold the button for 1 second or longer to enter the display adjust mode.

[T] button

- Press the button switches the user titles or track titles, etc. while in the CD changer mode.
- Press and hold the button for 1 second or longer to input a title in the CD changer mode.
- Press the button to scroll the title during CD-text play.

[BND] button

- Move the next disc in increasing order.

[UP] , [DN] buttons

- Select the disc.

[RDM] button

- Perform random play. Press and hold the button for 1 second or longer to perform disc random play.

[RPT] button

- Perform repeat play. Press and hold the button for 1 second or longer to perform disc repeat play.

[SCN] button

- Perform scan play for 10 seconds of each track.
Press and hold the button for 1 second or longer to perform disc scan play.

[◀◀, ▶▶] lever

- Select a track when listening to a disc.
- Press the lever upward or downward and hold in position for 1 second or longer to enter the fast-forward or fast-backward mode.

When the TV is connected

- * For details, see the section “**TV Operations**”.

[▶||] button

- Perform preset scan while in the TV mode.
Press and hold the button for 2 seconds or longer to perform auto store.

[BND] button

- Switch the band.
Press and hold the button for 1 second or longer to switch to the seek tuning or manual mode.

[DIRECT] buttons

- Store a station into memory or recall it directly.

[ADJ] button

- Press the button to switch to the ADJ mode.
- Press and hold the button for 1 second or longer to switch to the TV picture mode or VTR (external) picture mode.

[◀◀, ▶▶] lever

- Select a station.

4. PRECAUTIONS

1. When the inside of the car is very cold and the player is used soon after switching on the heater moisture may form on the disc or the optical parts of the player and proper playback may not be possible. If moisture forms on the disc, wipe it off with a soft cloth. If moisture forms on the optical parts of the player, do not use the player for about one hour. The condensation will disappear naturally allowing normal operation.
2. Driving on extremely bumpy roads which cause severe vibration may cause the sound to skip.
3. This unit uses a precision mechanism. Even in the event that trouble arises, never open the case, disassemble the unit, or lubricate the rotating parts.

⚠ CAUTION

USE OF CONTROLS, ADJUSTMENTS, OR PERFORMANCE OF PROCEDURES OTHER THAN THOSE SPECIFIED HEREIN, MAY RESULT IN HAZARDOUS RADIATION EXPOSURE.
THE COMPACT DISC PLAYER SHOULD NOT BE ADJUSTED OR REPAIRED BY ANYONE EXCEPT PROPERLY QUALIFIED SERVICE PERSONNEL.

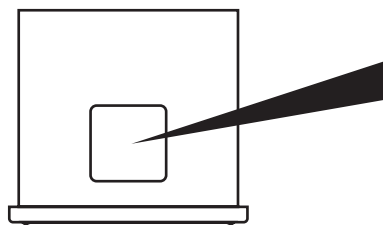

Bottom View of Source Unit

MODEL **DXZ366MP** Clarion

12V ⚡ GROUND

AM 531-1629kHz / FM 87.0-108MHz

This product includes technology owned by Microsoft Corporation and cannot be used or distributed without a license from MSLGP



SERIAL No.
PE-2802K

286-6793-00
Clarion Co.,Ltd.
MADE IN MALAYSIA

INFORMATION FOR USERS:

CHANGES OR MODIFICATIONS TO THIS PRODUCT NOT APPROVED BY THE MANUFACTURER WILL VOID THE WARRANTY.

5. HANDLING COMPACT DISCS

This unit has been designed specifically for playback of compact discs bearing the  or  mark. No other discs can be played.

To remove the compact disc from its storage case, press down on the center of the case and lift the disc out, holding it carefully by the edges.

Removing the disc

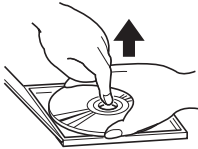

Proper way to hold the compact disc



Always handle the compact disc by the edges. Never touch the surface.

To remove fingermarks and dust, use a soft cloth, and wipe in a straight line from the center of the compact disc to the circumference.

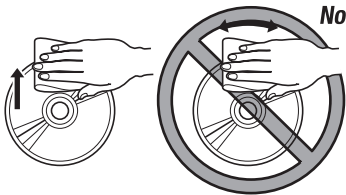

New discs may have some roughness around the edges. The unit may not work or the sound may skip if such discs are used. Use a ball-point pen, etc. to remove roughness from the edge of the disc.

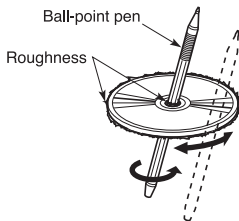

Note on compact discs

Never stick labels on the surface of the compact disc or mark the surface with a pencil or pen.

No

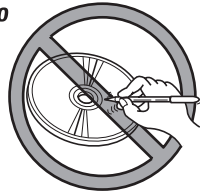

Do not use any solvents such as commercially available cleaners, anti-static spray, or thinner to clean compact discs.

No

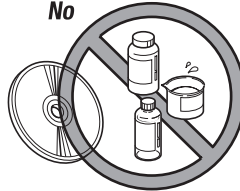

Do not use compact discs that have large scratches, are misshapen, or cracked, etc. Use of such discs will cause misoperation or damage.

No

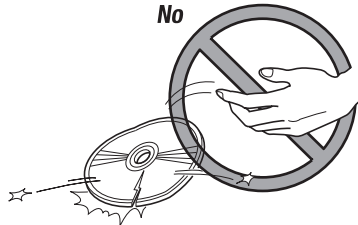

Do not expose compact discs to direct sunlight or any heat source.

No

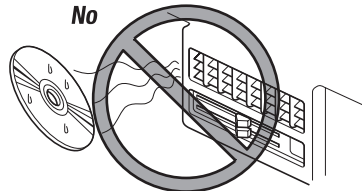

Note:

- Do not use commercially available CD protection sheets or discs equipped with stabilizers, etc. These may get caught in the internal mechanism and damage the disc.

6. DCP (Detachable Control Panel)

The control panel can be detached to prevent theft. When detaching the control panel, store it in the DCP (Detachable Control Panel) case to prevent scratches.

We recommend taking the DCP with you when leaving the car.

Removing the DCP

1. Press the [SRC] button for 1 second or longer to switch off the power.

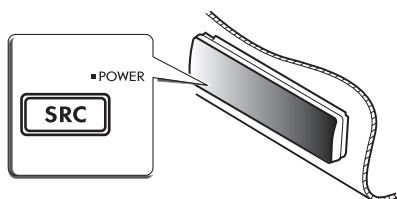

2. Press in the [OPEN] button.
 - * If the flip down panel does not open fully, gently open it with your hand.

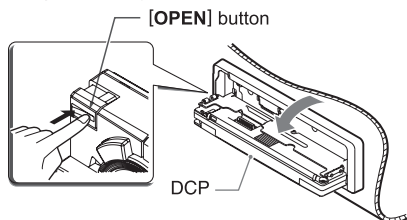

3. Pull the DCP toward you and remove it.

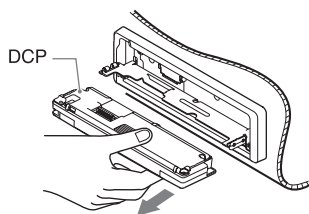

4. Close the HOLD FLAP.

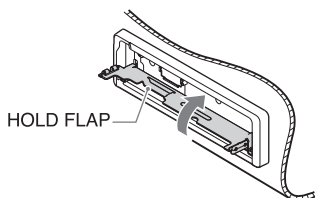

CAUTION

Be sure to close the HOLD FLAP for safety when removing the DCP.

Attaching the DCP

1. Insert the right side of the DCP into the main unit.
2. Insert the left side of the DCP to attach into the main unit.

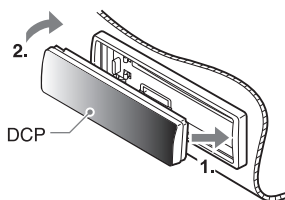

CAUTION

- The DCP can easily be damaged by shocks. After removing it, be careful not to drop it or subject it to strong shocks.
- If the FLIP DOWN PANEL is kept open, the DCP may drop due to vibration of the car. This results in damage to the DCP. So close the FLIP DOWN PANEL or remove the DCP to store into the case.
- The connector connecting the main unit and the DCP is an extremely important part. Be careful not to damage it by pressing on it with fingernails, pens, screwdrivers, etc.

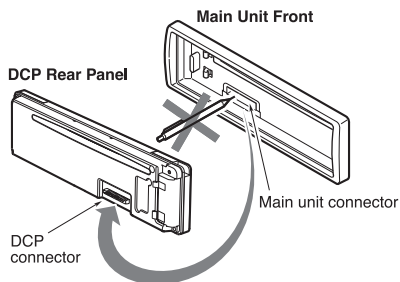

Note:

- If the DCP is dirty, wipe off the dirt with a soft, dry cloth only.

7. REMOTE CONTROL

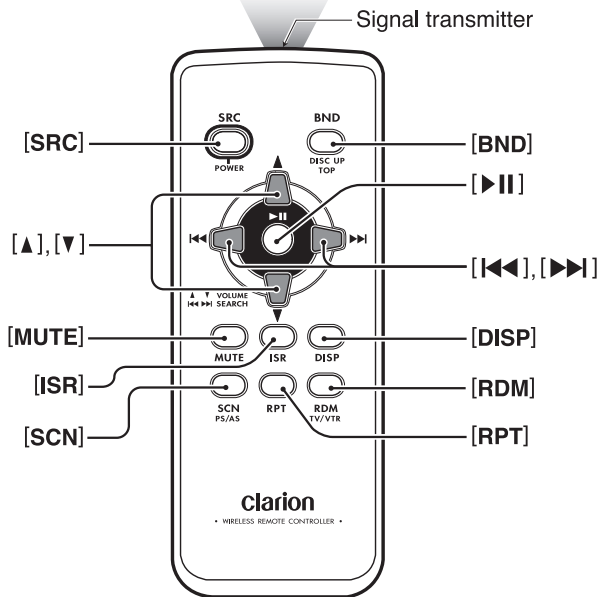

Inserting the Battery

1. Turn over the remote control unit and slide the cover in the direction indicated by the arrow in the illustration.
2. Insert the battery (CR2025) into the insertion guides, with the printed side (+) facing upwards.
3. Press the battery in the direction indicated by the arrow so that it slides into the compartment.
4. Replace the cover and slide in until it clicks into place.

Notes:

Misuse may result in rupture of the battery, producing leakage of fluid and resulting in personal injury or damage to surrounding materials. Always follow these safety precautions:

- Use only the designated battery.
- When replacing the battery, insert properly, with +/- polarities oriented correctly.
- Do not subject battery to heat, or dispose of in fire or water. Do not attempt to disassemble the battery.
- Dispose of used batteries properly.

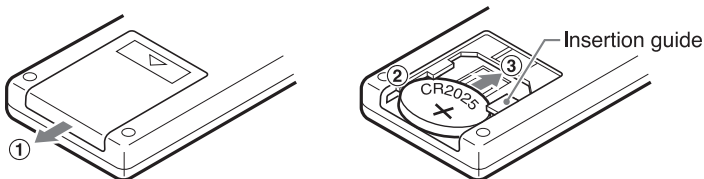

Functions of Remote Control Unit Buttons

| Mode Button | Radio | CD/MP3/WMA | CD Changer DVD Changer | TV |
|----------------|--|---|---|--|
| [SRC] | Press the button to power on. Press and hold the button for 1 second or longer: Power off. Switch among radio, CD/MP3/WMA, CD changer, DVD changer and TV. | | | |
| [BND] | Switch reception band. | Play the first track. Top play. | Move the next disc in increasing order. | Switch reception band. |
| [▲], [▼] | Increase and decrease volume (in all modes). | | | |
| [◀◀], [▶▶] | Move preset channels up and down. | Move tracks up and down. Press and hold the button for 1 second or longer: Fast-forward/fast-backward. | | Move preset channels up and down. |
| [▶▶] | No function. | Switch between playback and pause. | | No function. |
| [MUTE] | Turn mute on and off. | | | |
| [ISR] | Recall ISR radio station in memory. Press and hold for 2 seconds or longer: Store current station into ISR memory (radio mode only). | | | |
| [DISP] | Switch among main display, title display, clock display. | | | |
| [SCN] | Preset scan. Press and hold the button for 2 seconds or longer: Auto store. | Scan play. Press and hold the button for 1 second or longer to perform folder scan play while in the MP3/WMA mode. | Scan play. Press and hold the button for 1 second or longer: Disc scan play. | Preset scan. Press and hold the button for 2 seconds or longer: Auto store. |
| [RPT] | No function. | Repeat play. Press and hold the button for 1 second or longer to perform folder repeat play while in the MP3/WMA mode. | Repeat play. Press and hold the button for 1 second or longer: Disc repeat play. | No function. |
| [RDM] | No function. | Random play. Press and hold the button for 1 second or longer to perform folder random play while in the MP3/WMA mode. | Random play. Press and hold the button for 1 second or longer: Disc random play. | Switch between TV and VTR. |

* Some of the corresponding buttons on the main unit and remote control unit have different functions.

8. OPERATIONS

Basic Operations

Note: Be sure to read this chapter referring to the front diagrams of chapter "2. CONTROLS" on page 3.

CAUTION

Be sure to lower the volume before switching off the unit power or the ignition key. The unit remembers its last volume setting. If you switch the power off with the volume up, when you switch the power back on, the sudden loud volume may hurt your hearing and damage the unit.

Turning on/off the power

Note:

- Be careful about using this unit for a long time without running the engine. If you drain the car's battery too far, you may not be able to start the engine and this can reduce the service life of the battery.

1. Press the [SRC] button.
2. The illumination and display on the unit light up. The unit automatically remembers its last operation mode and will automatically switch to display that mode.
3. Press and hold the [SRC] button for 1 second or longer to turn off the power for the unit.

Notes:

- System check
The first time this unit is turned on after the wire connections are completed, it must be checked what equipment is connected. When the power is turned on, the "SYSTEM CHK" appears in the display, then the unit returns to the clock display mode. The system check starts within the unit. When the system check is complete, press the [SRC] button again.

Selecting a mode

1. Press the [SRC] button to change the operation mode.
2. Each time you press the [SRC] button, the operation mode changes in the following order:

Radio mode → CD/MP3/WMA mode →
CD changer mode → DVD changer mode
→ TV mode → Radio mode...

- * External equipment not connected with CeNET is not displayed.

Note:

- If the CD mode is selected when no disc is inserted, the display shows "NO DISC".

Switching the display

Press the [D] button to select the desired display.

Each time you press the [D] button, the display switches in the following order:

Main display → Title display → Clock display
→ Main display

- * Once selected, the preferred display becomes the display default. When a function adjustment such as volume is made, the screen will momentarily switch to that function's display, then revert back to the preferred display several seconds after the adjustment.
- * When you have entered a title in a CD/MP3/WMA, it appears in the title display. If you have not entered a title, "NO TITLE" appears in the title display instead.

For information on how to enter a title, refer to the subsection "Entering titles" in section "Operations Common to Each Mode".

Adjusting the volume

Turning the [ROTARY] knob clockwise increases the volume; turning it counter-clockwise decreases the volume.

- * The volume level is from 0 (minimum) to 33 (maximum).

Audio mode adjustments

1. Press the [A-M] button to select the adjustment mode. The mode switches as follows each time the [A-M] button is pressed:

BASS → TREB → BAL → FAD → Previous mode

Basic Operations

- Turning the **[ROTARY]** knob to adjust the selected audio mode.

BASS (Bass) : Adjustment range : -6 to +7

TREB (Treble): Adjustment range : -6 to +6

BAL (Balance): Adjustment range : L13 to R13

FAD (Fader) : Adjustment range : F12 to R12

- * The display returns to the previous mode 7 seconds after the adjustment.

Setting the Z-Enhancer

This unit are provided with 3 types of sound tone effects stored in memory. Select the one you prefer.

- * The factory default setting is "**Z-EHCR OFF**".

Each time you press the **[Z]** button, the tone effect changes in the following order:

"**Z-EHCR OFF**" → "**BASS BOOST**" → "**IMPACT**" → "**EXCITE**" → "**Z-EHCR OFF**" ...

- BASS BOOST: bass emphasized
- IMPACT : bass and treble emphasized
- EXCITE : bass and treble emphasized mid de-emphasized
- Z-EHCR OFF : no sound effect

Adjusting the balance

- Press the **[A-M]** button and select "**BAL 0**".
- Turning the **[ROTARY]** knob clockwise emphasizes the sound from the right speaker; turning it counterclockwise emphasizes the sound from the left speaker.

- * The factory default setting is "**BAL 0**".
(Adjustment range: L13 to R13)

- When the adjustment is complete, press the **[A-M]** button several times until the function mode is reached.

Adjusting the fader

- Press the **[A-M]** button and select "**FAD 0**".
- Turning the **[ROTARY]** knob clockwise emphasizes the sound from the front speakers; turning it counterclockwise emphasizes the sound from the rear speakers.
 - * The factory default setting is "**FAD 0**".
(Adjustment range: F12 to R12)
- When the adjustment is complete, press the **[A-M]** button several times until the function mode is reached.

Adjusting MAGNA BASS EX

The MAGNA BASS EX does not adjust the low sound area like the normal sound adjustment function, but emphasizes the deep bass sound area to provide you with a dynamic sound.

- * The factory default setting is off.

- Press and hold the **[A-M]** button for 1 second or longer to turn on the MAGNA BASS EX effect. "**M-B EX**" lights in the display.
- Press and hold the **[A-M]** button for 1 second or longer to turn off the MAGNA BASS EX effect. "**M-B EX**" goes off from the display.

Radio Mode Operations

Listening to the radio

1. Press the [SRC] button and select the radio mode, then the radio will be on.
2. To select a preset band, press the [BND] button, then select one of the preset bands such as FM1, FM2, FM3 or AM. Every time the [BND] button is pressed, the display will change as:
FM1 → FM2 → FM3 → AM → FM1...
3. Press the [◀▶] lever upward or downward to tune in the desired station.

Seek tuning

1. Press the [BND] button and select the desired band (FM or AM).
 - * If "MANU" is lit in the display, press and hold the [BND] button for 1 second or longer. "MANU" in the display goes off and seek tuning is now available.
2. Press the [◀▶] lever upward or downward to start automatic station tuning.
When the lever is pressed upward, search will be performing in the direction of higher frequencies. When the lever is pressed downward, search will be performed in the direction of lower frequencies.

Manual tuning

There are 2 ways available: Quick tuning and step tuning.

When you are in the step tuning mode, the frequency changes one step at a time. In the quick tuning mode, you can quickly tune the desired frequency.

1. Press the [BND] button and select the desired band (FM or AM).
 - * If "MANU" is not lit in the display, press and hold the [BND] button for 1 second or longer. "MANU" is lit in the display and manual tuning is now available.
2. Tune into a station.

● Quick tuning:

Press the [◀▶] lever upward or downward and hold in position for 1 second or longer to begin station tuning.

● Step tuning:

Press the [◀▶] lever upward or downward to perform manual tuning.

Preset memory function

Preset memory function can store up to 24 stations:

six stations for each of FM1, FM2, FM3 and AM.

Manual memory function

1. Press the [BND] button, to select a band you want to store in the memory.
2. Press the [◀▶] lever to tune into a desired station.
3. Press and hold one of the [DIRECT] button for 2 seconds or longer to store the current station into preset memory.

Auto store

Auto store is a function for storing up to 6 stations that are automatically tuned in sequentially. If 6 receivable stations cannot be received, a previously stored station remains unoverwritten at the memory position.

1. Press the [BND] button and select the desired band (FM or AM).
2. Press and hold the [PS/AS] button for 2 seconds or longer. The stations with good reception are stored automatically to the preset channels.

Preset scan

Preset scan receives the stations stored in preset memory in order. This function is useful when searching for a desired station in memory.

1. Press the [PS/AS] button.
2. When a desired station is tuned in, press the [PS/AS] button again to continue receiving that station.

Radio Mode Operations

Note:

- Be careful not to press and hold the [PS/AS] button for 2 seconds or longer, otherwise the auto store function is engaged and the unit starts storing stations.

Recalling a preset station

A total of 24 preset positions (6-FM1, 6-FM2, 6-FM3, 6-AM) exists to store individual radio stations in memory. Pressing the corresponding [DIRECT] button recalls the stored radio frequency automatically.

1. Press the [BND] button and select the desired band (FM or AM).
2. Press the corresponding [DIRECT] button to recall the stored station.
 - * Press and hold one of the [DIRECT] buttons for 2 seconds or longer to store that station into preset memory.

Instant station recall (ISR)

Instant station recall is a special radio preset that instantly accesses a favorite radio station at a touch of a button. The ISR function even operates with the unit in other modes.

● ISR memory

1. Select the station that you wish to store in ISR memory.
2. Press and hold the [ISR] button for 2 seconds or longer.

● Recalling a station with ISR

In any mode, press the [ISR] button to turn on the radio function and tune the selected radio station. "ISR" appears in the display. Press the [ISR] button again to return to the previous mode.

CD/MP3/WMA Mode Operations

What is MP3?

MP3 is an audio compression method and classified into audio layer 3 of MPEG standards. This audio compression method has penetrated into PC users and become a standard format. This MP3 features the original audio data compression to about 12 percent of its initial size with a high quality sound. This means that about 10 music CDs can be recorded on a CD-R disc or CD-RW disc to allow a long listening time without having to change CDs.

What is WMA?

WMA is the abbreviation of Windows Media Audio, an audio file format developed by Microsoft Corporation.

Notes:

- If you play a file with DRM (Digital Rights Management) for WMA remaining ON, no audio is output.
- Windows Media™, and the Windows® logo are trademarks, or registered trademarks of Microsoft Corporation in the United States and/or other countries.

● To disable DRM (Digital Rights Management):

1. When using Windows Media Player 8, click on TOOLS → OPTIONS → COPY MUSIC tab, then under COPY SETTINGS unclick the check box for PROTECT CONTENT. Then, reconstruct files.
2. When using Windows Media Player 9, click on TOOL → OPTIONS → MUSIC RECORD tab, then under Recording settings, unclick the Check box for RECORD PROTECTED MUSIC. Then, reconstruct files. Personally constructed WMA files are used at your own responsibility.

● Precautions when creating MP3/WMA disc

- Usable sampling rates and bit rates:
 1. MP3: Sampling rate 11.025 kHz-48 kHz, Bit rate: 8 kbps-320 kbps/VBR
 2. WMA: Bit rate 48 kbps-192 kbps

CD/MP3/WMA Mode Operations

● File extensions

- Always add a file extension “.MP3” or “.WMA” to MP3 or WMA file by using single byte letters. If you add a file extension other than specified or forget to add the file extension, the file cannot be played.

● Logical format (File system)

1. When writing MP3/WMA file on a CD-R disc or CD-RW disc, please select “**ISO9660 level 1, 2 or JOLIET or Romeo**” as the writing software format. Normal play may not be possible if the disc is recorded on another format.
2. The folder name and file name can be displayed as the title during MP3/WMA play but the title must be within 64 single byte alphabetical letters and numerals (including an extension).
3. Do not affix a name to a file inside a folder having the same name.

● Folder structure

1. A disc with a folder having more than 8 hierarchical levels will be impossible.

● Number of files or folders

1. Up to 255 files can be recognized per folder. Up to 512 files can be played.
2. Tracks are played in the order that they were recorded onto a disc. (Tracks might not always be played in the order displayed on the PC.)
3. Some noise may occur depending on the type of encoder software used while recording.

CD-DA/MP3/WMA selection on multi-session CD

1. If a multi-session CD which contains CD-DA and MP3/WMA files is being inserted, user can select either CD-DA or MP3/WMA files to be played.
2. Default setting for files to be played on multisession CD is CD-DA files.
3. Press the [BND] button for more than 1 second will toggle between selection of CD-DA and [MP3/WMA] files to be played.
4. When CD-DA type is selected, display will show “**M-SESS CD**”. When MP3/WMA type is selected, display will show “**M-SESS MP3**”.

5. CD-DA/MP3/WMA selection function can only be performed in CD/MP3/WMA mode. It will only activate after re-insert CD. For example, current setting is CD-DA type. Press [BND] button for more than 1 second to set MP3/WMA type. User has to eject CD and re-insert again as to play MP3/WMA files.
6. Types of recording that can be played are as follows.

| Disc \ Setting | Set to CD | Set to MP3/WMA |
|---------------------------------------|--------------|----------------|
| Mixed with CD and MP3/WMA type tracks | Play CD | Play MP3/WMA |
| CD type track only | Play CD | Play CD |
| MP3/WMA type track only | Play MP3/WMA | Play MP3/WMA |

7. When a mixed mode CD is loaded and CD is set, the track to be played first is MP3/WMA file data and no sound is heard.

Note:

- When playing a CCCD (Copy Control CD), set the setting to CD type. When this is set to MP3/WMA type, the CD cannot be played normally in some cases.

Disc-In-Play function

As long as the ignition key is turned to the ON or ACC position, this function allows you to turn the power to the unit and start playing the disc automatically when the disc is inserted even if the power is not turned on.

CAUTION

- Do not try to put your hand or fingers in the disc insertion slot. Also never insert foreign objects into the slot.
- Do not insert discs where adhesive comes out from cellophane tape or a rental CD label, or discs with marks where cellophane tape or rental CD labels were removed. It may be impossible to extract these discs from the unit and they may cause the unit to break down.

Backup eject function

Just pressing the [] button ejects the disc even if the power to the unit was not turned on.

1. Press the [OPEN] button to open the FLIP DOWN PANEL.

CD/MP3/WMA Mode Operations

Note:

- If the FLIP DOWN PANEL will not open far enough, open it gently with your hand.
2. Press the [▲] button. Remove the disc after it is ejected.
 3. Close the FLIP DOWN PANEL.

Notes:

- Always close the FLIP DOWN PANEL once you take out the disc.
- If you force a CD into before auto reloading, this can damage the CD.
- If a CD (12 cm) is left in the ejected position for 15 seconds, the CD is automatically reloaded. (Auto reload).
- 8 cm CDs are not auto reloaded. Be sure to remove it when ejected.

Listening to a disc already loaded in the unit

Press the [SRC] button to select the CD/MP3/WMA mode.

When the unit enters the CD/MP3/WMA mode, play starts automatically.

If there is no disc loaded, the indication **"NO DISC"** appears in the title display.



- * The mode changes each time the [SRC] button is pressed. (Modes are not displayed for equipment that is not connected.)

Radio → **CD/MP3/WMA** → **(CD changer)** → **(DVD changer)** → **(TV)** → **Radio...**

Loading a CD

1. Press the [OPEN] button to access the CD SLOT behind the FLIP DOWN PANEL.
2. Insert a CD into the center of the CD SLOT with the labeled side facing up. The CD plays automatically after loading.

Notes:

- Never insert foreign objects into the CD SLOT.
- If the CD is not inserted easily, there may be another CD in the mechanism or the unit may require service.
- Discs not bearing the  or  mark and CD-ROMs cannot be played by this unit.
- Some CDs recorded in CD-R/CD-RW mode may not be usable.

Loading 8 cm CD

- * No adapter is required to play an 8 cm CD.
 - * Insert the 8 cm CD into the center of the insertion slot.
3. Close the FLIP DOWN PANEL.

CAUTION

Be careful not to catch your hand or fingers while closing the FLIP DOWN PANEL.

Notes:

- If the FLIP DOWN PANEL does not open fully, gently open with your hand.
- After loading a CD, always close the FLIP DOWN PANEL.

Pausing play

1. Press the [▶||] button to pause play. **"PAUSE"** appears in the display.
2. To resume CD play, press the [▶||] button again.

Displaying CD titles

This unit can display title data for CD-text/MP3/WMA disc and user titles input with this unit.

1. Press the [D] button to display the title.
2. Each time you press the [T] button, the title display changes in the following order:

● CD-TEXT data

User title (disc) → CD-text title (disc) → Artist name → CD-text title (track) → User title (disc)...

● MP3/WMA disc

Folder → Track → Album TAG → Artist TAG → Title TAG → Folder...

Notes:

- If the CD playing is not a CD-text data or no user title has been input, **"NO TITLE"** appears in the display.
- If MP3/WMA disc is not input TAG, **"NO TAG"** appears in the display.
- For MP3, supports ID3 Tags V2.3/2.2/1.1/1.0.
- Tag displays give priority to V2.3/2.2
- In the case of album Tags for WMA, the information written into the extension header is displayed.
- Only ASCII characters can be displayed in Tags.

CD/MP3/WMA Mode Operations

Display selection

1. You can choose the display type for MP3/WMA CD by pressing the [D] button.

To select the next type, press the [D] button again.

The arrangement is shown below.

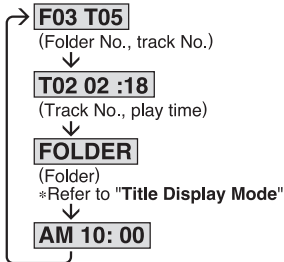

Title display mode

1. There are 5 types of display for the Title Display mode.
2. To select the next type, press the [T] button for less than 1 second.

The arrangement is shown below.

After 2 seconds

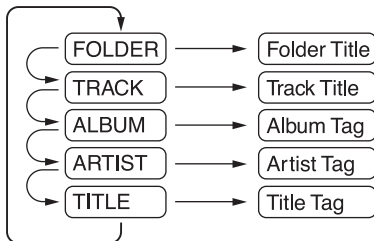

3. The displayed item can be scrolled by pressing the [T] button for more than 1 second.
4. If a MP3/WMA file does not support for ID3 TAG, the display will show "NO TAG"
5. If a MP3/WMA file encode with ID3 TAG header but no consist of any TAG information, the display will show nothing.

Notes:

- The folder name will be displayed as "ROOT" which the file allocates in the root folder.
- The MP3 player decodes each file ID3 TAG ver 2 by default, if ID3 TAG ver 2 is unavailable, ID3 TAG ver 1 will be decoded.
- UNICODE ID3 (Chinese, Japanese and etc) is not supported.

Selecting a track

● Track-up

1. Press the [▶▶] lever upward to move to the beginning of the next track.
2. Each time the [▶▶] lever is pressed upward, playback proceeds to another track in the advancing direction.

● Track-down

1. Press the [◀◀] lever downward to move the beginning of the current track.
2. Press the [◀◀] lever downward twice to move to the beginning of the previous track.

Fast-forward/fast-backward

● Fast-forward

Press the [▶▶] lever upward and hold in position for 1 second or longer.

● Fast-backward

Press the [◀◀] lever downward and hold in position for 1 second or longer.

* For MP3/WMA discs, it takes some time until the start of searching and between tracks. In addition, the playing time may have a margin of error.

MP3/WMA playing order

When selected for play folder up down functions, files and folders are accessed in the order in which they were written by the CD-ROM writer. Because of this, the order in which they are expected to be played may not match the order in which they are actually played. You may be able to set the order in which MP3/WMA are to be played by writing them onto a medium such as a CD-R with their file names beginning with play sequence numbers such as "01" to "99", depending on your CD writer.

For example, a medium with the following folder/file hierarchy is shown below.

CD/MP3/WMA Mode Operations

Example of a medium's folder/file hierarchy

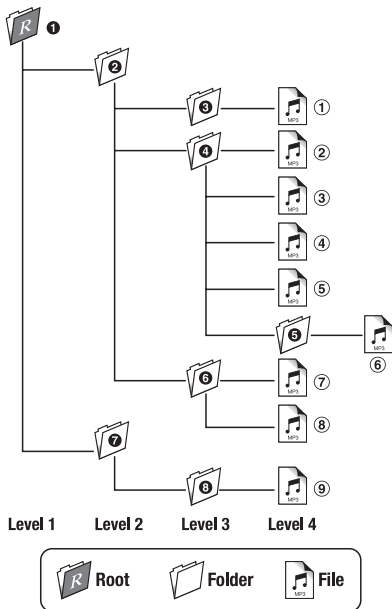

Folder select

This function allows you to select a folder containing MP3/WMA files and start playing from the first track in the folder.

1. Press the [DN] or the [UP] button.

Press the [DN] button to move the previous folder. Press the [UP] button to move the next folder.

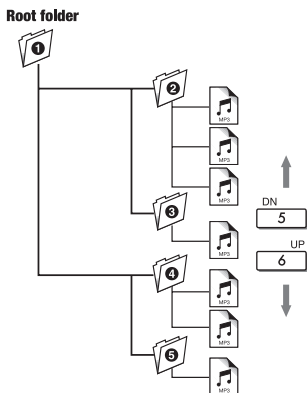

- * Press the [UP] button while in the final folder to shift to the first folder.
- * Folder without an MP3/WMA file is not selectable.

2. To select a track, press the [◀◀, ▶▶] lever upward or downward.

Top function

The top function resets the CD player to the first track of the disc. Press the [BND] button to play the first track (Track No. 1) on the disc.

- * In case of MP3/WMA, the first track of a folder being played will be returned.

Other various play functions

● Scan play

This function allows you to locate and play the first 10 seconds of all the tracks recorded on a disc.

1. Press the [SCN] button to perform scan play. The indication "SCN" lights in the display.
 - * Scan play starts from the next track after the track currently being played.

● Folder scan play

This function allows you to locate and play the first 10 seconds of the first track of all the folders on an MP3/WMA disc.

1. Press and hold the [SCN] button for 1 second or longer to perform folder scan play. The indications "ALL..." and "SCN" light in the display.
 - * Folder scan play starts from the next track after the track currently being played.

● Repeat play

This function allows you to play the current track repeatedly.

1. Press the [RPT] button to perform repeat play. The indication "RPT" lights in the display.

● Folder repeat play

This function allows you to play a track currently being played in the MP3/WMA folder repeatedly.

1. Press and hold the [RPT] button for 1 second or longer to perform folder repeat play. The indications "ALL..." and "RPT" light in the display.

CD/MP3/WMA Mode Operations

● Random play

This function allows you to play all tracks recorded on a disc in a random order.

1. Press the [RDM] button to perform random play.

The indication "RDM" lights in the display.

● Folder random play

This function allows you to play all the tracks of all the folders recorded on an MP3/WMA disc in a random order.

1. Press and hold the [RDM] button for 1 second or longer to perform folder random play.

The indications "ALL..." and "RDM" light in the display.

● To cancel play

1. Press the operating button previously selected.

Operations Common to Each Mode

To change display setting

1. Press and hold the [D] button for 1 second or longer to switch to the adjustment selection display.

2. Press the [◀▶] lever upward or downward to select the "item name".

"CLOCK(E)" ↔ "SCREEN SVR" ↔ "MSG INP(E)" ↔ "AUTO SCROL" ↔ "DIMMER"

3. Turn the [ROTARY] knob to select the "desired setting value".

* In the case of item names appearing with the "E" suffix, after the item name, the [▶] button must be pressed to display the setting value.

* After completing settings, press the [D] button to return to the previous mode.

● Setting the clock

- 2-1. Select "CLOCK <E>".

- 3-1. Press the [▶] button.

- 3-2. Press the [◀▶] lever upward or downward to select the hour or the minute.

- 3-3. Turn the [ROTARY] knob to set the correct time.

* The clock is displayed in 12-hour format.

- 3-4. Press the [▶] button to store the time into memory.

Note:

- You cannot set the clock when it is displayed with only the ignition on. If you drain or remove the car's battery or take out this unit, the clock is reset. While setting the clock, if another button or operation is selected, the clock set mode is canceled.

● Turning the screen saver function on or off

This unit is provided with the screen saver function which allows you to show various kinds of patterns and characters in the operation status indication area of the display in a random order. You can turn on and off this function.

If the button operation is performed with the screen saver function on, the operation display corresponding to the button operation is shown for about 30 seconds and the display returns to the screen saver display.

* The factory default setting is "ON".

Operations Common to Each Mode

2-1. Select "**SCREEN SVR**".

3-1. Turn the [ROTARY] knob to select the setting.

Each time you turn the [ROTARY] knob, the setting changes in the following order:

SS OFF → SS ON → SS MESSAGE.

● Entering MESSAGE INFORMATION

Message up to 30 characters long can be stored in memory and displayed as a type of screen saver setting.

* The factory default setting is "**WELCOME TO CLARION**".

2-1. Select "**MSG INP <E>**".

3-1. Press the [▶] button.

3-2. Press and hold [BND] button for 1 second or longer to clear the old message.

3-3. Press the [◀▶] lever upward or downward to move the cursor.

3-4. Press the [BND] button to select a character. Each time you press the [BND] button, the character changes in the following orders:
Capital letters → Numbers → Symbols → Capital letters...

3-5. Turn the [ROTARY] knob to select the desired character.

3-6. Repeat step 3-3 to 3-5 to enter up to 30 characters for message.

3-7. Press and hold the [▶] button for 2 seconds or longer to store the message in memory and cancel input message mode.

* Press and hold the [BND] button for 1 second or longer to cancel the input message. Then press and hold the [▶] button for 2 seconds or longer to store the message and the message return to default setting.

● Setting the method for title scroll

Set how to scroll in CD-TEXT, MP3/WMA title.

* The factory default setting is "**ON**".

2-1. Select "**AUTO SCROL**".

3-1. Turn the [ROTARY] knob to select "**ON**" or "**OFF**".

● ON:

To scroll automatically.

● OFF:

To scroll just 1 time when the title was changed or the [T] button was pressed for 1 second or longer.

● Dimmer control

You can setting the dimmer control "**ON**" or "**OFF**".

* The factory default setting is "**ON**".

2-1. Select "**DIMMER**".

3-1. Turn the [ROTARY] knob to select "**ON**" or "**OFF**".

To change other settings

1. Press the [ADJ] button to switch to the adjustment selection display.

2. Press the [◀▶] lever upward or downward to select the "**item name**".

Each time the [◀▶] lever is pressed up/down, the item display changes in the following order:

"BLINK LED" ↔ "AMP CANCEL" ↔ "SYS CHK(E)"

3. Turn the [ROTARY] knob to select the "**desired setting item**".

* After completing settings, press the [ADJ] button to return to the previous mode.

● Anti-theft indicator

The red Anti-theft indicator is a function for preventing theft. When the DCP is removed from the unit, this indicator blinks.

* The factory default setting is "**OFF**".

2-1. Select "**BLINK LED**".

3-1. Turn the [ROTARY] knob to select "**ON**" or "**OFF**".

● Setting the external amplifier

* The factory default setting is "**OFF**".

2-1. Select "**AMP CANCEL**".

3-1. Turn the [ROTARY] knob to select "**ON**" or "**OFF**".

Operations Common to Each Mode

- **ON:**

Use with connected AMP.

- **OFF:**

Use with inside AMP.

- **Performing a system check**

This function allows you to perform a system check from the adjust mode when required.

2-1. Select "SYS CHK <E>".

3-1. Press and hold the [▶||] button for 1 second or longer.

"SYSTEM CHK" appears in the display, then the unit returns to the previous operation mode.

Entering titles

Titles up to 10 characters long can be stored in memory and displayed for CD, CD changer and TV stations. The number of titles that can be entered for each mode are as follows.

| Mode | Number of titles |
|------------|------------------|
| CD mode | 50 titles |
| TV mode | 20 titles |
| Tuner mode | 30 titles |

| CD changer mode | Number of titles |
|--------------------|------------------|
| DCZ625 connected | 100 titles |
| CDC655Tz connected | 100 titles |

1. Press the [SRC] button to select the mode you want to enter a title (TUNER, CD, CD changer or TV).
2. Select and play a CD in the CD changer or tune in to a TV station or TUNER for which you want to enter the title.
3. Press the [D] button and display the title display.
4. Press and hold the [T] button for 1 second or longer.
The display switches to the title input display.
5. Press the [◀◀, ▶▶] lever upward or downward to move the cursor.
6. Press the [BND] button to select a character.
Each time you press the [BND] button, the character changes in the following order:
Capital letters → Numbers → Symbols → Capital letters...

7. Turn the [ROTARY] knob to select the desired character.
8. Repeat steps 5 to 7 to enter up to 10 characters for the title.
9. Press and hold the [▶||] button for 2 seconds or longer to store the title into memory and cancel title input mode.

Clearing titles

1. Select and play a CD in the CD changer or tune in to a TV station or TUNER for which you want to clear the title.
2. Press the [D] button and display the title display.
3. Press and hold the [T] button for 1 second or longer.
The display switches to the title input display.
4. Press and hold the [BND] button for 1 second or longer.
All characters in the title disappear.
5. Press and hold the [▶||] button for 2 seconds or longer to clear the title and cancel title input mode.

9. OPERATIONS OF ACCESSORIES

CD Changer Operations

Note:

- The following operations are the same as for CD mode:
 - * **Pause**
 - * **Track selection**
 - * **Fast-forward/fast-backward**
 - * **Scan play**
 - * **Repeat play**
 - * **Random play**
- See “**CD/MP3/WMA Mode Operations**” (page 14-19) for details.

CD changer functions

When an optional CD changer is connected through the CeNET cable, this unit controls all CD changer functions. This unit can control a total of 2 changers.

Press the [SRC] button and select the CD changer mode to start play. If 2 CD changers are connected, press the [SRC] button to select the CD changer for play.

- * If “**NO MAG**” appears in the display, insert the magazine into the CD changer. “**DISC CHECK**” appears in the display while the player loads (checks) the magazine.
- * If “**NO DISC**” appears in the display, eject the magazine and insert discs into each slot. Then, reinsert the magazine back into the CD changer.

Note:

- Some CDs recorded in CD-R/CD-RW mode may not be usable.

CAUTION

CD-ROM discs cannot be played from every CD changer, it's depended on the model.

Displaying CD titles

This unit can display title data for CD-text CDs and user titles input with this unit.

- * Title data for CD-text CDs can be displayed with this unit only when it is connected to CDC655Tz.

1. Press the [D] button to display the title.
2. Each time you press the [T] button, the title display changes in the following order:

User title (disc) → CD-text title (disc) →
Artist name → CD-text title (track) → User
title (disc)...

Notes:

- If the CD playing is not a CD-text CD or no user title has been input, “**NO TITLE**” appears in the display.
- If a CD-text CD is not input its disc title or a track title, “**NO TITLE**” appears in the display.

Procedure to scroll a title

Set “**SCROLL**” to “**ON**” or “**OFF**”.

(The factory default setting is “**ON**”. Refer to the subsection “**Turning the screen saver function on or off**” in section “**Operation common to each mode**”.)

• When set to “**ON**”

The title is automatically kept scrolling.

• When set to “**OFF**”

To scroll just 1 time when the title was changed or the [T] button was pressed for 1 second or longer.

Selecting a CD

Press the [UP] or [DN] button to select the desired disc.

- * If a CD is not loaded in a slot of magazine, pressing the [UP] or [DN] button can not work.

Other various play functions

● Disc scan play

Disc scan play locates and plays the first 10 seconds of the first track on each disc in the currently selected CD changer. This function continues automatically until it is cancelled.

CD Changer Operations

* Disc scan play is useful when you want to select a desired CD.

1. Press and hold the **[SCN]** button for 1 second or longer. “**ALL...**” and “**SCN**” light in the display and disc scan play starts.

● Disc repeat play

After all the tracks on the current disc have been played, disc repeat play automatically replays the current disc over from the first track.

This function continues automatically until it is cancelled.

1. Press and hold the **[RPT]** button for 1 second or longer. “**ALL...**” and “**RPT**” light in the display and disc repeat play starts.

● Disc random play

The disc random play selects and plays individual tracks or discs automatically in no particular order.

This function continues automatically until it is cancelled.

1. Press and hold the **[RDM]** button for 1 second or longer. “**ALL...**” and “**RDM**” light in the display and disc random play starts.

● To cancel play

1. Press the operating button previously selected.

TV Operations

Note:

- The following operations are performed the same as for radio mode:

- * **Channel selection**
- * **Storing channels in memory**
- * **Calling channels from memory**
- * **Auto store**
- * **Preset scan**

See “**Radio Mode Operations**” (page 13-14) for details.

TV tuner functions

When an optional TV tuner is connected through the CeNET cable, this unit controls all TV tuner functions. To watch TV requires a TV tuner and monitor.

Watching a TV

1. Press the **[SRC]** button and select the TV mode.
2. Press the **[BND]** button to select the desired TV band (TV1 or TV2). Each time the button is pressed, the input selection toggles between TV1 and TV2.
3. Press the **[◀▶]** lever upward or downward to tune in the desired TV station.

Watching a video

The TV tuner has a VTR input terminal to which 1 external device can be connected. Connect a 12 V video cassette player (VCP) or videocassette recorder (VCR) to the TV tuner input terminal.

1. Press and hold the **[ADJ]** button for 1 second or longer to select VTR.
2. To return to the TV broadcast, press and hold the **[ADJ]** button for 1 second or longer.

Setting the TV area

When you select the TV area (TV reception area), the TV tuner area setting changes.

1. Press the **[ADJ]** button to switch to the adjustment selection display.
2. Press the **[◀▶]** lever upward or downward to select “**TV AREA <E>**”.
3. Press the **[▶|]** button.
4. Turn the **[ROTARY]** knob to select the reception area.

TV Operations

5. Press the [▶||] button.
6. Press the [ADJ] button to return to the previous mode.

Setting the TV diver

You can change the reception setting for the TV antenna connected to the TV tuner.

1. Press the [ADJ] button to switch to the adjustment selection display.
2. Press the [◀◀, ▶▶] lever upward or downward to select "TV DIVER".
3. Turn the [ROTARY] knob clockwise to set to "ON" or counterclockwise to set to "OFF".

- **ON:**

Sets the diver setting to ON.

- **OFF:**

Sets the diver setting to OFF.

4. Press the [ADJ] button to return to the previous mode.

10. TROUBLESHOOTING

| | Problem | Cause | Measure |
|---------|--|---|--|
| General | Power does not turn on. (No sound is produced) | Fuse is blown. | Replace with a fuse of the same amperage. If the fuse blows again, consult your store of purchase. |
| | | Incorrect wiring. | Consult your store of purchase. |
| | No sound output when operating the unit with amplifiers or power antenna attached. | Power antenna lead is shorted to ground or excessive current is required for remote-on the amplifiers or power antenna. | <ol style="list-style-type: none"> 1. Turn the unit off. 2. Remove all wires attached to the power antenna lead. Check each wire for a possible short to ground using an ohm meter. 3. Turn the unit back on. 4. Reconnect each amplifier remote wire to the power antenna lead one by one. If the amplifiers turn off before all wires are attached, use an external relay to provide remote-on voltage (excessive current required). |
| | Nothing happens when button are pressed. Display is not accurate. | The microprocessor has malfunctioned due to noise, etc. | Turn off the power, then press the [OPEN] button and remove the DCP. Press the reset button for about 2 seconds with a thin rod. |
| | | DCP or main unit connectors are dirty. | Wipe the dirt off with a soft cloth moistened with cleaning alcohol. |
| | No sound heard. | The speaker protection circuit is operating. | <ol style="list-style-type: none"> 1. Turn down sound volume. Function can also be restored by turning the power off and on again. (Speaker volume is reduced automatically when the speaker protection circuit operates). 2. If the sound is muted again, consult our service department. |

Troubleshooting

| | Problem | Cause | Measure |
|----------------|---|---|--|
| CD/MP3/WMA | No sound heard. | MP3/WMA files are absent in a disc. | Write MP3/WMA files onto the disc properly. |
| | | Files are not recognized as an MP3/WMA file. | Use MP3/WMA files encoded properly. |
| | | File system is not correct. | Use ISO9660 level 1, 2 or JOLIET or Romeo file system. |
| | Sound skips or is noisy. | Disc is dirty. | Clean the disc with a soft cloth. |
| | | Disc is heavily scratched or warped. | Replace with a disc with no scratches. |
| | Sound is cut or skipped. Noise is generated or noise is mixed with sound. | MP3/WMA files are not encoded properly. | Use MP3/WMA files encoded properly. |
| | Sound is bad directly after power is turned on. | Water droplets may form on the internal lens when the car is parked in a humid place. | Let dry for about 1 hour with the power on. |
| Wrong filename | File system is not correct. | Use ISO9660 level 1, 2 or JOLIET or Romeo file system. | |

11. ERROR DISPLAYS

| | Error Display | Cause | Measure |
|------------|---------------|--|--|
| CD/MP3/WMA | ERROR 2 | A DISC is caught inside the CD deck and is not ejected. | This is a failure of CD deck's mechanism and consult your store of purchase. |
| | ERROR 3 | A DISC cannot be played due to scratches, etc. | Replace with a non-scratched, non-warped-disc. |
| | ERROR 6 | A DISC is loaded upside-down inside the CD deck and does not play. | Eject the disc then reload it properly. |

| | Error Display | Cause | Measure |
|------------|---------------|---|---|
| CD Changer | ERROR 2 | A CD inside the CD changer is not loaded. | This is a failure of CD changer's mechanism and consult your store of purchase. |
| | ERROR 3 | A CD inside the CD changer cannot be played due to scratches, etc. | Replace with a non-scratched, non-warped disc. |
| | ERROR 6 | A CD inside the CD changer cannot be played because it is loaded upside-down. | Eject the disc then reload it properly. |

| | Error Display | Cause | Measure |
|-------------|---------------|--|--|
| DVD Changer | ERROR 2 | A DISC inside the DVD changer cannot be played. | This is a failure of DVD mechanism and consult your store of purchase. |
| | ERROR 3 | A DISC cannot be played due to scratches, etc. | Retry or replace with a non-scratched, non-warped-disc. |
| | ERROR 6 | A DISC inside the DVD changer cannot be played because it is loaded upside-down. | Eject the disc then reload it properly. |
| | ERROR P | Parental level error. | Set the correct Parental level. |
| | ERROR R | Region code error. | Eject the disc and replace correct region code disc. |

12. SPECIFICATIONS

FM tuner

Frequency Range: 87.0 MHz to 108 MHz
 Usable Sensitivity: 11 dBf
 50 dB Quieting Sensitivity: 17 dBf
 Alternate Channel Selectivity: 75 dB
 Stereo Separation (1 kHz): 35 dB
 Frequency Response (± 3 dB): 30 Hz to 15 kHz

AM tuner

Frequency Range:
 AM 531 kHz to 1629 kHz
 Usable Sensitivity: 25 μ V

CD player

System: Compact disc audio system
 Usable Discs: Compact disc
 Frequency Response: 10 Hz to 20 kHz (± 1 dB)
 Signal-to-Noise Ratio: 85 dB (1 kHz) IHF-A
 Dynamic Range: 80 dB (1 kHz)
 Harmonic Distortion: 0.01%

MP3

Decode Format: MPEG 1,2 and 2.5 -Layer 3
 Sampling rate (kHz): MPEG-1: 32,44,1,48
 MPEG-2: 16,22,05,24
 MPEG-2.5: 8,11,025,12
 Bit-rate (kbps): 8, 16, 24, 32, 40, 48, 56, 64,
 80, 96, 112, 128, 144, 160, 192,
 224, 256, 320, VBR
 CD-ROM Format: ISO9660 Level 1, 2, Romeo
 and Joliet
 Folder Level Limit: 8 Level
 Folder Support: 255
 File Support: 512
 Folder Name: Maximum 64 bytes
 File Name: Maximum 64 bytes

Audio

Maximum Power Output: 200 W (50 W X 4 ch)
 Continuous Average Power Output:
 17 W X 4, into 4 Ω , 20 Hz to 20 kHz, 1%THD
 Bass Control Action (100 Hz): ± 14 dB
 Treble Control Action (10 kHz): ± 14 dB
 Line Output (with A/C 1 kHz, 10 k Ω): 1.8 V

General

Power Supply Voltage:
 14.4 V DC (10.8 V to 15.6 V allowable), negative ground
 Current Consumption: Less than 15 A
 Speaker Impedance: 4 Ω (4 Ω to 8 Ω allowable)
 Weight: 2.42 lb. (1.1 kg)
 Dimensions:
 178 mm Width X 50 mm Height X 152 mm Depth

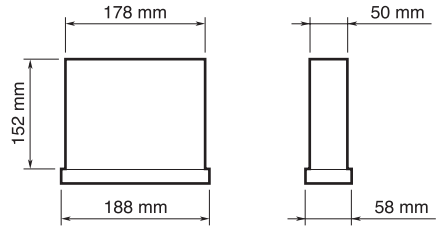

Notes:

- Specifications comply with JEITA Standards.
- Specifications and design are subject to change without notice for further improvement.
- Please make sure when connecting external power amplifier, that you properly, to the car chassis, ground the amplifier.
- If this is not done, severe damage to the source unit may happen.

Clarion Co., Ltd.

All Rights Reserved. Copyright © 2006: Clarion Co., Ltd.
Printed in Malaysia / 在马来西亚印刷 / 인쇄국: 말레이시아

PE-2802K
280-8345-00

Free Manuals Download Website

<http://myh66.com>

<http://usermanuals.us>

<http://www.somanuals.com>

<http://www.4manuals.cc>

<http://www.manual-lib.com>

<http://www.404manual.com>

<http://www.luxmanual.com>

<http://aubethermostatmanual.com>

Golf course search by state

<http://golfingnear.com>

Email search by domain

<http://emailbydomain.com>

Auto manuals search

<http://auto.somanuals.com>

TV manuals search

<http://tv.somanuals.com>