

Clarion

**MARINE
POWER SYSTEM**

APX480M

**OPERATION/
INSTALLATION
MANUAL**

Clarion APX480M Power System Amplifier

INTRODUCTION

The Clarion APX480M is a full-featured four-channel amplifier incorporating the following features:

- Specially coated circuit boards, that resist mold, mildew and moisture damage.
- Pulse-Width Modulated (PWM) MOSFET power supply for maximum performance with minimal distortion.
- Remote turn-on with "soft start" muting to prevent turn-on "thump".
- Advanced circuitry design featuring bridgeable and mixed mode operation for use in various system configurations including 4, 3, or 2 channel systems.
- Variable high-pass/low-pass electronic crossover with a 12dB per octave slope (adjustable range: 55Hz to 5.5kHz).
- Variable bass boost circuit to reinforce low frequency signals that may be lost due to subwoofer enclosure design.
- Adjustable input level controls with ground loop isolation to minimize noise and distortion.
- 2-ohm stereo stable, 4-ohm mono stable.
- Gold-plated power, speaker, and RCA connectors.
- Speaker level input.
- Low profile construction with aluminum heat sink for efficient heat dissipation.

ABOUT THE MANUAL AND WARRANTY

This manual describes the basic requirements to install the Clarion APX480M amplifier. The installation of this amplifier can be quite complex to install, if you do not possess the necessary knowledge and tools to perform this installation, please contact your local Clarion dealer.

Keep all instructions and sales receipt for future reference and warranty information. Warranty information can be found on page 11 of this manual.

TABLE OF CONTENTS

Description	1
Input Connections and Audio Controls	1
Connections for Power and Speakers	3
Installation	4
Mounting Precautions	4
Wiring Precautions	4
Wiring and Applications	75
Setting the Gain	10
Setting the Crossover	10
Setting the Bass Boost	10
Final System Check	11
Troubleshooting	11
Product Specs	12
Clarion Limited Warranty	13

DESCRIPTION

The APX480M uses an unregulated MOSFET power supply for superior sound and output wattage. In addition, a toroid-coil is used to transfer power with minimal performance loss due to heat. To avoid unwanted noise, a double-sided conformal printed circuit board with strategically placed components keeps AM RFI subdued.

All of the connections and controls for the APX480M are conveniently located at the ends of the amplifier and labeled appropriately. To ensure the best possible electrical connections, the power, speaker, and RCA inputs are gold-plated. An additional benefit of this amplifier is the ability to create a 2, 3, or 4 channel amplified system with a flip of a switch (see Application section). In the event of component failure or a short circuit, the APX480M incorporates safe guards and an outboard ATC fuse to prevent damage to the amplifier

INPUT CONNECTIONS AND AUDIO CONTROLS

The front panel of the APX480M contains both connections for RCA and speaker level inputs, along with the audio controls as shown below.

Figure 1-

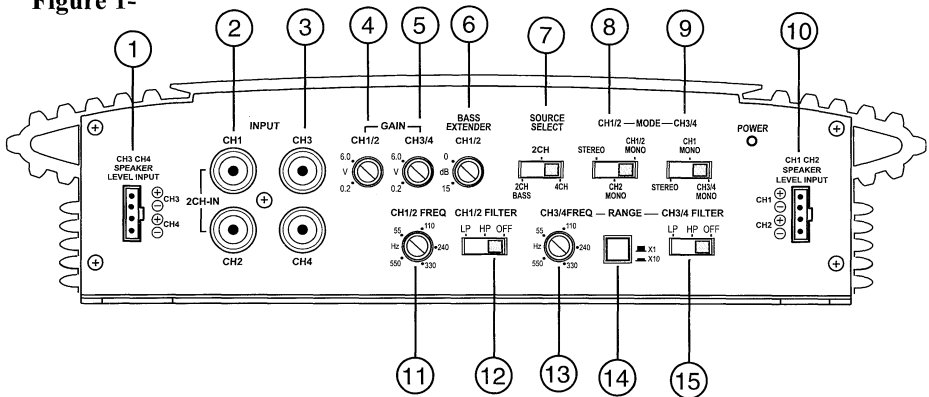

- | | |
|-------------------------------|----------------------------------|
| 1. CH 3/4 Speaker Level Input | 9. CH 3/4 Mode Switch |
| 2. CH 1/2 RCA Level Input | 10. CH 1/2 Speaker Level Input |
| 3. CH 3/4 RCA Level Input | 11. CH 1/2 Frequency Control |
| 4. CH 1/2 Gain Control | 12. CH 1/2 Crossover Mode Switch |
| 5. CH 3/4 Gain Control | 13. CH 3/4 Frequency Control |
| 6. CH 1/2 Bass Extender | 14. Frequency Range Multiplier |
| 7. Source Select | 15. CH 3/4 Crossover Mode Switch |
| 8. CH 1/2 Mode Switch | |

Clarion APX480M Power System Amplifier

The RCA connections are gold plated for optimum performance and low signal loss. The RCA connectors are labeled CH 1 (front left), CH 2 (front right), CH 3 (rear left), and CH 4 (rear right). In applications where RCA signals are not present, the speaker level output from the head unit can be used. (Use one or the other input, not both.)

- **Gain Controls** - Separate CH 1/2 and CH 3/4 gain controls allow you to set the nominal operating level of the amplifier. The amplifier's input range, 250mV to 2.5V for RCA inputs and 500mV to 5V for speaker level inputs, can accommodate input levels from virtually any head unit.
- **Bass Extender** - The amplifier features a "high-Q" (i.e. narrow frequency band) Bass Boost circuit. It acts much like an equalizer with an adjustable gain from 0 to +18dB fixed at 45Hz. Use this feature to tune low-frequency audio response to compensate for a less than ideal subwoofer enclosure design. The added boost produces rich, full bass tones that are normally difficult to reproduce in the car audio environment. NOTE: If bass boost is undesired, set Bass Extender to 0dB.
- **Source Select**
 - 2 CH BASS: Uses CH 1/2 inputs and has output from all 4 channels with Bass Extender.
 - 2 CH: Uses CH 1/2 inputs and has output from all 4 channels. The Bass Extender will work only on CH 1/2 and have no effect on CH 3/4.
 - 4 CH: Uses all 4 channel inputs and has output from all 4 channels. The Bass Extender will work only on CH 1/2 and have no effect on CH 3/4.
- **Output Mode Selector Switch: (CH 1/2 and CH 3/4)**
 - STEREO: Full left and right stereo operation.
 - CH 1 Mono / CH 2 Mono: Single channel input for bridged operation. This is especially useful in high-powered systems. (Uses CH 2 and CH 4 inputs.)
 - CH 1/2 Mono / CH 3/4 Mono: Allows for a stereo input to be summed into a mono output.
- **CH 1/2 FREQ / CH 3/4 FREQ** - The CH 1/2-crossover frequencies are adjustable from 55Hz to 550Hz. While CH 3/4-crossover frequencies are adjustable from 55Hz to 5500Hz (via the Frequency Range Multiplier) for a wider range of crossover points. Use this feature along with your speaker manufacturer's recommended crossover frequencies to quickly design a more advanced system. NOTE: If either of the Crossover Mode Switches is set to OFF, varying the frequency control will have no effect.
- **CH 1/2 Filter / CH 3/4 Filter** - A filter is activated by sliding the CH 1/2 and CH 3/4 filter switch to either HP or LP. CH 1/2 is fully adjustable from 55-550Hz (via CH 1/2 Freq) and CH 3/4 is fully adjustable from 55-5500Hz (via CH 3/4 Frequency and Frequency Range Multiplier). Use this feature along with your speaker manufacture's recommended crossover frequencies to design a more advanced system.

- **CH 3/4 Frequency Range Multiplier** - When engaged, this switch increases the crossover frequency of CH 3/4 by a factor of 10.
Example: If the frequency hertz dial is set to 240Hz, pushing in the Frequency Range Multiplier changes the setting to 2400Hz.

CONNECTIONS FOR POWER AND SPEAKERS

The rear panel of the APX480M contains power and speaker connections as shown below.

Figure 2

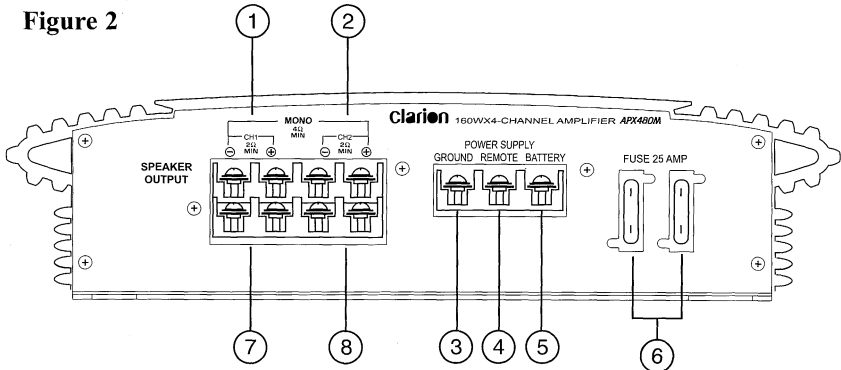

- | | |
|-------------------------|----------------------------|
| 1. CH1 Speaker Output | 5. Battery + 12v Input |
| 2. CH2 Speaker Output | 6. (2) 25Amp Fuses |
| 3. Ground Input | 7. CH3 Speaker Output |
| 4. Remote Turn-on Input | 8. CH4 Rear Speaker Output |

Figure 3 - Electrical connections

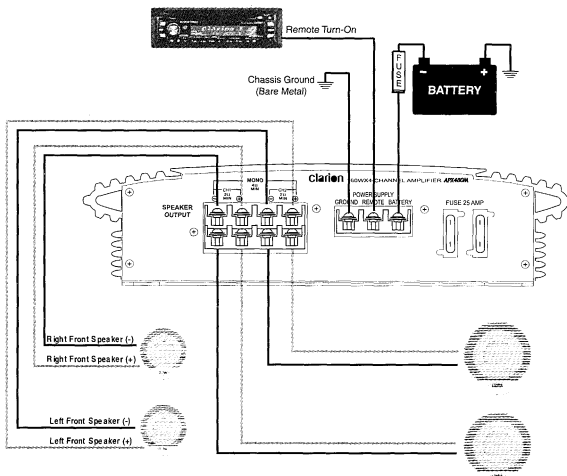

INSTALLATION

This section suggests Mounting and Wiring Precautions for installing the Clarion APX480M amplifier. If you do not possess the necessary tools and installation experience, do not attempt to install this amplifier. Instead, contact your local Clarion dealer to perform the installation.

MOUNTING PRECAUTIONS

Prior to mounting the amplifier, make sure it is safe to mount the amplifier in that location. Failure to do so can result in serious damage to the boat. In addition, stainless steel hardware should be used to mount the amplifier and additional accessories. When possible, use a nut and bolt with a lock washer to secure the amplifier. Extra care and attention is necessary in marine installations due to the uncertainty of water conditions.

Additional precautions and suggestions:

1. For the most efficient cooling, mount the amplifier so cool air runs along the length of the heat sink, rather than across them. To increase air movement and circulation, a cooling fan can be installed.
2. Mount the amplifier on a rigid surface; avoid mounting to subwoofer enclosures or areas prone to vibration.
3. Prior to drilling and holes, make sure the proposed mounting holes will not cut into the fuel tank, fuel lines, electrical wiring, or through the boat.
4. Do not mount the amplifier where it is susceptible to water.

WIRING PRECAUTIONS

Read all of the wiring precautions prior to making any connections. If you are unsure and/or don't have the necessary installation hardware, contact your local Clarion dealer to perform the installation.

1. Before you begin the installation, make sure the source unit Power switch is in the OFF position.
2. Disconnect the negative (-) lead of the battery (or batteries) before making any power connections.
3. When making connections, be sure that each connection is clean and secure. Insulate final connections with electrical tape or shrink tubing. Failure to do so may damage your equipment.
4. A good ground is critical for the performance of the amplifier. A ground wire should be run directly from the battery to the amplifier. Use black insulated 10-gauge or larger wire for the amplifier's ground (-) power lead.
5. Add an additional fuse holder and fuse at the positive (+) terminal of the battery. The fuse rating should equal the total current consumption at full output of the amplifier(s). Use red insulated 10-gauge or larger wire for the amplifier's positive (+) power lead. Do not install the fuse until the complete installation has been performed.

6. When replacing the amplifier's fuse, always use one having the same amperage rating. Substituting a higher rated fuse or a slow-blow type can result in serious damage to the amplifier.
7. When creating passage holes for power cables, RCA's cords, and speaker wires, use grommets to eliminate any sharp edges created during drilling. This will protect the wire from being nicked and causing a short circuit.
8. Extra cable can cause signal loss and act as an "antenna" for noise. Use only high-quality RCA cords that are no longer than necessary.
9. In multiple amplifier systems, it is recommended to use a relay on the remote turn-on lead of the radio.

WIRING AND APPLICATIONS

The Clarion APX480M 4-channel marine amplifier can be used in a variety of system applications. Here are some examples to help plan your own installation.

4-Channel Full-Range Stereo System

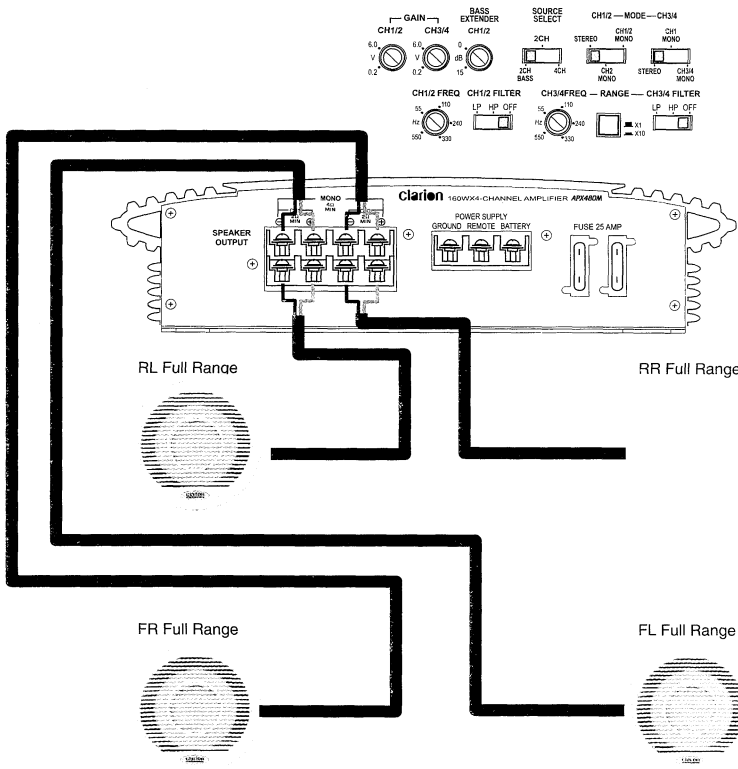

Figure 4

In this application, the APX480M is used as a 4-channel amplifier to drive four full-range speakers in stereo.

4-Channel Stereo System 2-Channel High-Pass, 2-Channel Low-Pass

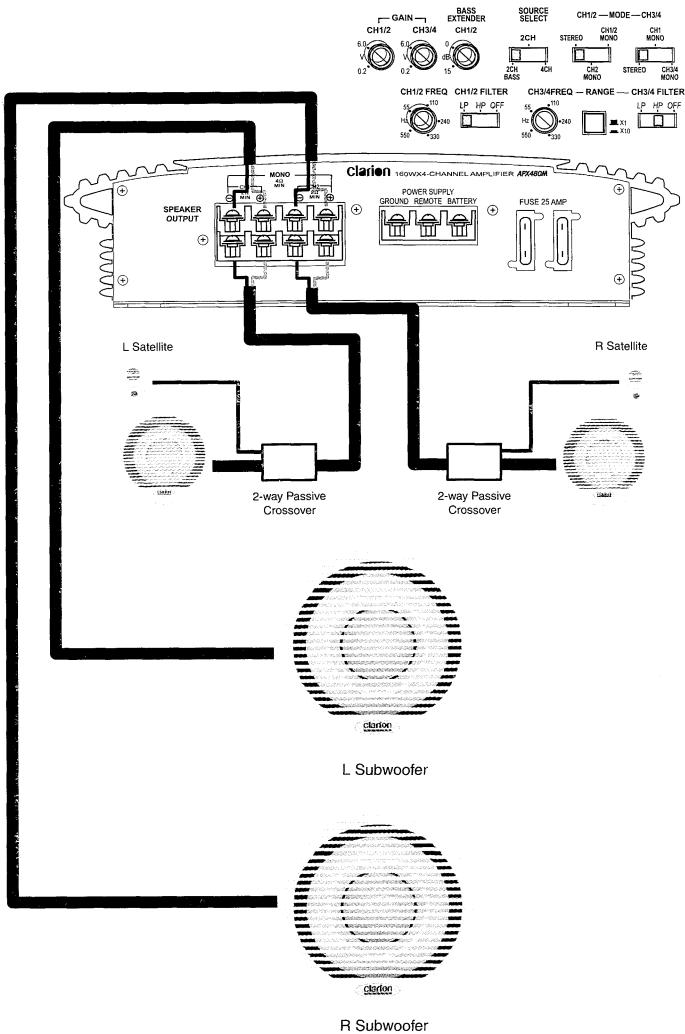

Figure 5

In this 4-channel system, the APX480M drives a pair of stereo satellites for the front and a pair of subwoofers for the rear. Note the filter settings.

2-Channel Stereo System with Low-Pass Bridged Mono Channel

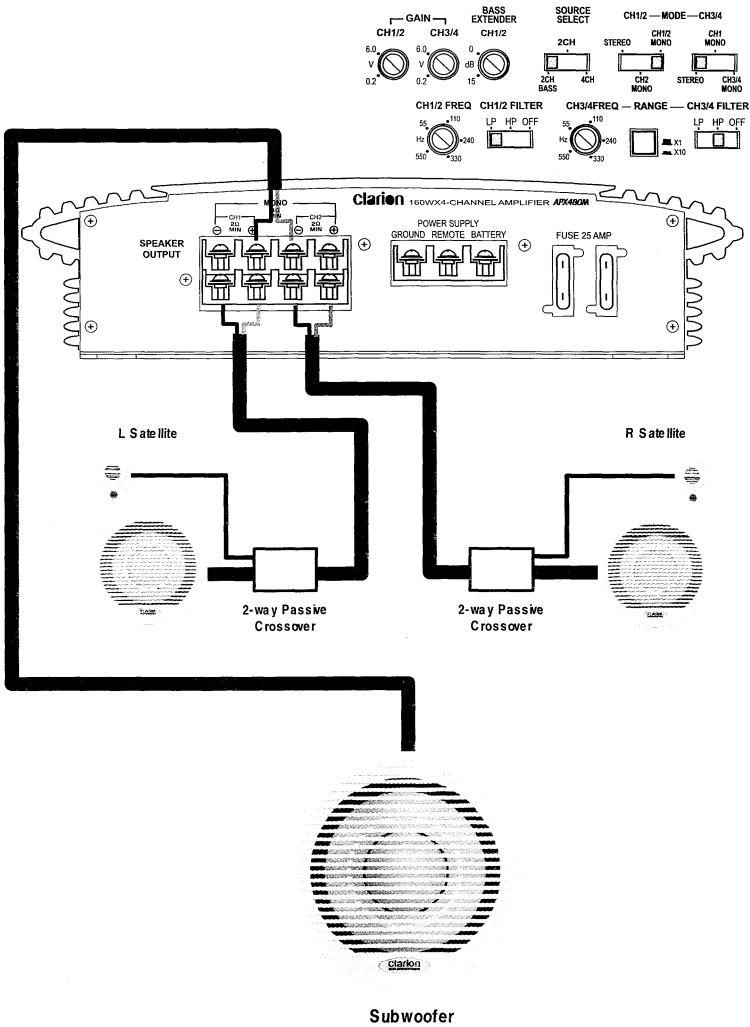

Figure 6

The APX480M can also be used to drive a pair of stereo satellites for the front and a single mono subwoofer for the rear. Note the filter settings.

2-Channel High Power System (Satellite or Subwoofer)

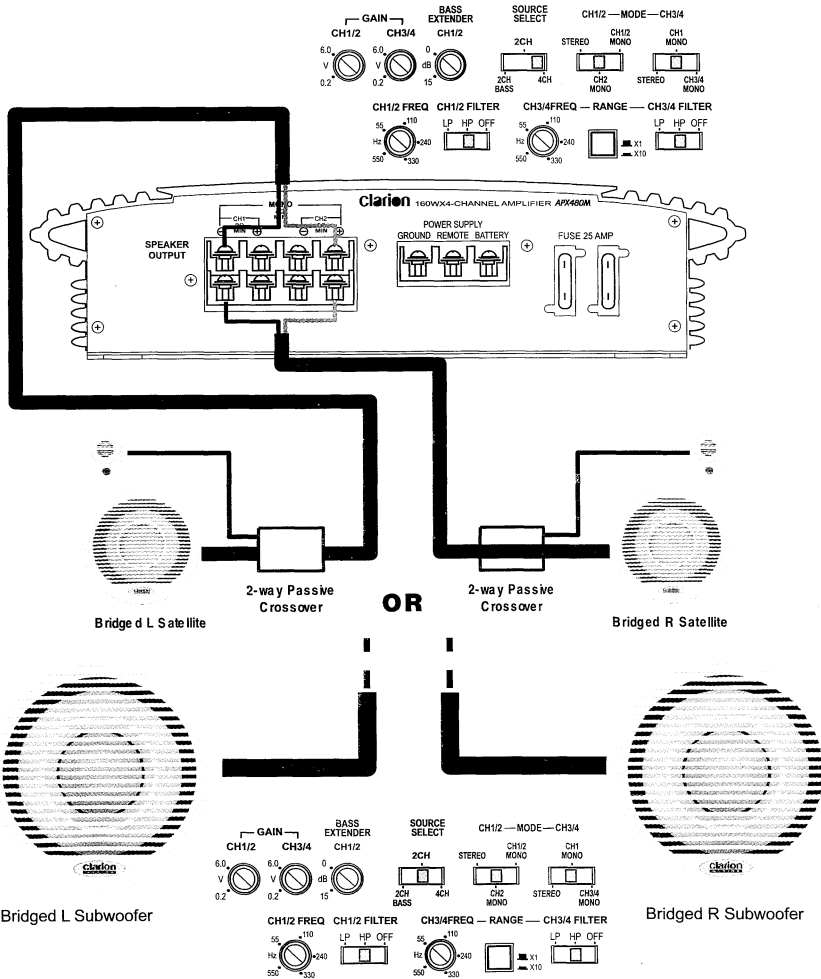
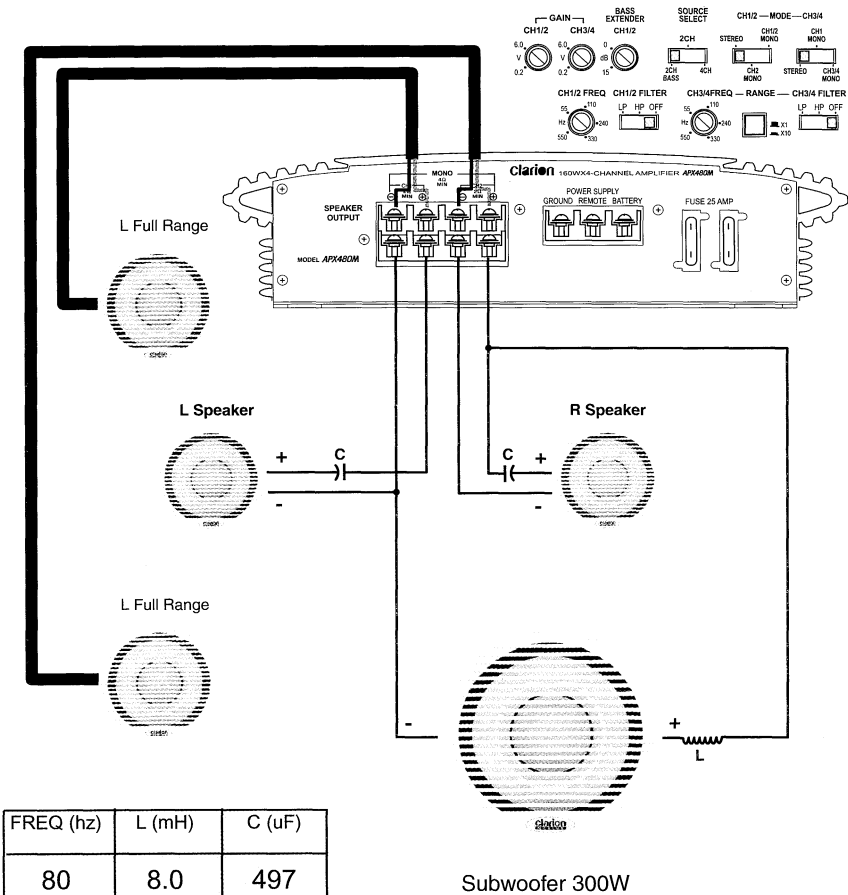

Figure 7

The APX480M can be set up as a 2-channel high-power amplifier to drive a pair of satellites (or subwoofers).

Mixed-Mode System On Rear; Full-Range Speakers On Front



NOTE: Chart values based on 4 Ohm speakers.

Figure 8

The amplifier can be configured for a mixed-mode operation on either channels 1/2 or 3/4 amplifier sections. The table provides component values to create a 6dB per octave crossover at specified frequencies. Use components that have a $\pm 5\%$ tolerance and capacitors rated at 100V. **NOTE:** Choose the same frequency for both LP and HP crossovers. Do not overlap frequencies, as this may damage the amplifier.

SETTING THE GAIN

After completing the installation, follow these steps to set the Gain Control and then perform the Final System Checks.

1. Turn the Gain Control all the way counter-clockwise.
2. Turn the vehicle's Ignition Switch to the ON position. Then turn the ON/OFF Switch on the source units to the ON position. Set all Tone or Equalization Controls to "flat" positions and turn Loudness off.
3. Play a CD or Tape and set the Volume Control at 75% of full level.
NOTE: If the system uses an equalizer, set its frequency controls to "flat" positions.
4. Slowly increase the Gain Control. Stop when you hear a slight distortion of audio.

SETTING THE CROSSOVER

The Clarion APX480M features fully adjustable front and rear crossovers. To set the crossovers, follow these steps.

1. Using the X-Over Mode Switch, select the desired mode: LP for Low Pass, HP for High Pass or OFF for Full Range.
2. Using the Freq (Hz) Selection Control, select the desired frequency. If the desired frequency exceeds the range of the Freq (Hz) Selection Control, press the Crossover Frequency Multiplier Switch to increase the value by a multiplier of 10.
 - For example, $55\text{Hz} \times 10 = 550\text{Hz}$ or $550\text{Hz} \times 10 = 5.5\text{kHz}$.
3. Repeat steps 1 and 2 for both the front and rear crossovers.

SETTING THE BASS BOOST

1. Initially set the Bass Boost control to its full left position (i.e. 0dB).
2. Listen to a variety of music styles (e.g. Rock, Rap, etc.) and slowly increase the Bass Boost control until a noticeable increase in low bass response is perceived.
3. Slowly adjust the Bass Boost control (up or down) to realize the best bass response.

CAUTION: If you hear a "pop" (due to speaker over-excursion), lower the Bass Boost to prevent speaker damage. If the system sounds muddy and distorted (due to amplifier clipping), lower Bass Boost to avoid shutdown from overheating.

FINAL SYSTEM CHECK

1. Start the engine and turn on the source unit. After a two-second delay, slowly increase the Volume Control and listen to the audio. If you hear any noise, static, distortion or no sound at all, check the connections, and also refer to Troubleshooting. Depending on your system design, the levels may become quite loud even at low Volume Control settings. Until you get an "audio feel" of the system's power, use care when adjusting controls.
2. Turn the Balance Controls to their extreme positions and listen to the results. Audio output should match control settings (audio from the left speaker when balance is left).
3. Increase the volume and verify that the amplifier reproduces audio (at full frequencies) without distortion. If you hear distortion, check the connections and verify that the Gain Control is set correctly. Another possibility is damaged speakers or under-powered speakers. Once again refer to Troubleshooting for additional help.

TROUBLESHOOTING**Problem**

No Audio.

Solution

Low or no remote turn-on voltage. Check remote connections at amplifier and source unit.

Blown amplifier fuse. Replace with new fast-blow fuse (same rating).

Power wires not connected. Check battery and ground wiring at amplifier; also check battery connections.

Speaker leads shorted. Check speaker continuity to ground, it should not show a common ground.

Speakers not connected or are blown. Check speaker connections at amplifier, measure coil impedance.

Problem

Audio cycles on and off.

Solution

Thermal protection circuits are shutting amplifier off. Check location for adequate ventilation; consult an authorized Clarion Audio Dealer.

Problem

Distorted audio.

Solution

Gain is not set properly, or damaged speaker cones. Review Setting Gain; inspect each speaker cone for signs of damage (i.e. frozen cone, burning smell, etc.)

Problem

Amplifier fuse keeps blowing.

Solution

Incorrect wiring or short circuit. Review Installation and check all wiring connections.

Problem

Whining or ticking noise in the audio with engine on.

Solution

Amplifier is picking up alternator noise or radiated noise. Turn down input gain; move audio cables away from power wires. Check power and ground connections on amplifier; install an in-line noise filter on source unit's power wire; check alternator and/or voltage regulator; test for weak battery or add water to battery.

PRODUCT SPECS

Frequency Response	20Hz ~ 20kHz
Signal Noise Ratio	>95db
THD	.05% all channels driven
Input Sensitivity Low Level	250mV ~ 2.5V
Input Sensitivity Speaker Level	500mV ~ 5V
Max. Power Output	640W (160 x4)
Cont. Power Output	320W (80W x4) @.05% THD
2-Ohm Stereo Output	115W x 4 @ .5% THD
Bridged Power	230W x 2 @ .5% THD
Dimensions	2 1/8" H x 8 1/4" W x 12" L
Current Consumption @ Max Power Output	46A @ 640 Watts

CLARION LIMITED WARRANTY

For USA and Canada only

If purchased from an authorized Clarion dealer, this product is warranted against all defects in materials and workmanship for a period of one (1) year from the date of original purchase. Clarion ProAudio products, except for speakers, are covered by a two (2) year limited warranty when purchased from and installed by an authorized Clarion dealer.

ALL PURCHASES OF CLARION PRODUCTS FROM NON-AUTHORIZED CLARION DEALERS ARE SUBJECT TO FURTHER WARRANTY RESTRICTIONS AS DESCRIBED BELOW.

The conditions of this limited warranty and the extent of responsibility of Clarion Corporation of America ("Clarion") under this limited warranty are as follows :

1. PROOF OF DATE OF PURCHASE WILL BE REQUIRED FOR WARRANTY SERVICE OF THIS PRODUCT. IN THE CASE OF THE TWO (2) YEAR LIMITED WARRANTY FOR CLARION PROAUDIO PRODUCT, PROOF OF INSTALLATION BY AN AUTHORIZED CLARION DEALER IS REQUIRED. INFORMATION ABOUT CLARION AUTHORIZED WARRANTY SERVICE CENTERS MAY BE OBTAINED BY CONTACTING OR WRITING CLARION AT THE ADDRESS LISTED BELOW.
2. This limited warranty will become void if service performed by anyone other than an approved Clarion Warranty Service Center results in damage to the product.
3. This limited warranty does not apply to any product which has been subject to misuse, neglect or accident, or which has had the serial number altered, defaced or removed, or which has been connected, installed, adjusted or repaired, other than in accordance with the instructions furnished by Clarion.
4. his limited warranty does not cover car static or other electrical interferences, tape head or laser pick-up cleaning or adjustments, or labor costs for the removal or reinstallation of the unit for repair.
5. The sole responsibility of Clarion under this limited warranty shall be limited to the repair of the product or replacement of the product, at the sole discretion of Clarion.
6. Product must be shipped in its original carton or equivalent carton, fully insured, with shipping charges prepaid. Clarion will not assume any responsibility for any loss or damage incurred in shipping.
7. CLARION PRODUCTS, INCLUDING PROAUDIO PRODUCTS, PURCHASED FROM A SOURCE OTHER THAN AN AUTHORIZED CLARION DEALER, INCLUDING ANY AND ALL PURCHASES VIA THE INTERNET FROM A NON INTERNET AUTHORIZED CLARION DEALER, SHALL NOT BE COVERED BY ANY CLARION LIMITED WARRANTY TO THE EXTENT ALLOWED BY APPLICABLE LAW. IN THE EVENT AND TO THE EXTENT APPLICABLE LAW PROHIBITS ELIMINATION OF WARRANTIES UNDER THESE CIRCUMSTANCES, THE APPLICABLE LIMITED WARRANTY PERIOD SHALL BE DEEMED TO BE FIFTEEN (15) DAYS FROM THE DATE OF ORIGINAL PURCHASE.
8. ALL IMPLIED WARRANTIES EXCEPT TO THE EXTENT PROHIBITED BY APPLICABLE LAW SHALL HAVE NO GREATER DURATION THAN THE WARRANTY PERIOD SET FORTH ABOVE. UNDER NO CIRCUMSTANCES SHALL CLARION BE LIABLE FOR ANY LOSS OR DAMAGE, DIRECT OR CONSEQUENTIAL, ARISING OUT OF THE USE OR INABILITY TO USE THE PRODUCT. BECAUSE SOME STATES DO NOT ALLOW LIMITATIONS ON HOW LONG AN IMPLIED WARRANTY LASTS OR EXCLUSIONS OR LIMITATIONS OF INCIDENTAL OR CONSEQUENTIAL DAMAGES, THE ABOVE LIMITATIONS OR EXCLUSIONS MAY NOT APPLY TO YOU
9. THIS LIMITED WARRANTY GIVES YOU SPECIFIC LEGAL RIGHTS, AND YOU MAY ALSO HAVE OTHER RIGHTS WHICH VARY FROM STATE TO STATE.
10. The laws of the State of California shall govern and control this limited warranty, its interpretation and enforcement.
11. Should you have any difficulties with the performance of this product during the warranty period, please call or visit our web site for a listing of Authorized Warranty Service Centers in your area. You may also contact the Clarion Customer Service at the address listed below for any service help you may need with Clarion products.

In USA:

Clarion Corporation of America
Attn:Customer Service Manager
661 W. Redondo Beach Blvd
Gardena, CA.90247-4201
1-800-GO-CLARION
(310)327-9100
www.clarion.com

In Canada:

Clarion Canada Inc.
Warranty Service Center
2239 Winston Park Drive
Oakville,Ontario L6H 5R1
(905)829-4600
www.clarioncanada.com



clarion

MARINE

661 W. Redondo Beach Blvd.
Gardena, CA 90247-4201 U.S.A.
1-800-GO-CLARION
www.clarion.com

APX480M Rev. 2 (06/04)
80-0480M-01

clarion[®]**CLARION LIMITED WARRANTY**

For USA and Canada only

If purchased from an authorized Clarion dealer, this product is warranted against all defects in materials and workmanship for a period of one (1) year from the date of original purchase. Clarion ProAudio products, except for speakers, are covered by a two (2) year limited warranty when purchased from and installed by an authorized Clarion dealer. **ALL PURCHASES OF CLARION PRODUCTS FROM NON-AUTHORIZED CLARION DEALERS ARE SUBJECT TO FURTHER WARRANTY RESTRICTIONS AS DESCRIBED BELOW.**

The conditions of this limited warranty and the extent of responsibility of Clarion Corporation of America ("Clarion") under this limited warranty are as follows :

- 1. PROOF OF DATE OF PURCHASE WILL BE REQUIRED FOR WARRANTY SERVICE OF THIS PRODUCT. IN THE CASE OF THE TWO (2) YEAR LIMITED WARRANTY FOR CLARION PROAUDIO PRODUCT, PROOF OF INSTALLATION BY AN AUTHORIZED CLARION DEALER IS REQUIRED. INFORMATION ABOUT CLARION AUTHORIZED WARRANTY SERVICE CENTERS MAY BE OBTAINED BY CONTACTING OR WRITING CLARION AT THE ADDRESS LISTED BELOW.**
- This limited warranty will become void if service performed by anyone other than an approved Clarion Warranty Service Center results in damage to the product.
- This limited warranty does not apply to any product which has been subject to misuse, neglect or accident, or which has had the serial number altered, defaced or removed, or which has been connected, installed, adjusted or repaired, other than in accordance with the instructions furnished by Clarion.
- This limited warranty does not cover car static or other electrical interferences, tape head or laser pick-up cleaning or adjustments, or labor costs for the removal or reinstallation of the unit for repair.
- The sole responsibility of Clarion under this limited warranty shall be limited to the repair of the product or replacement of the product, at the sole discretion of Clarion.
- Product must be shipped in its original carton or equivalent carton, fully insured, with shipping charges prepaid. Clarion will not assume any responsibility for any loss or damage incurred in shipping.
- 7. CLARION PRODUCTS, INCLUDING PROAUDIO PRODUCTS, PURCHASED FROM A SOURCE OTHER THAN AN AUTHORIZED CLARION DEALER, INCLUDING ANY AND ALL PURCHASES VIA THE INTERNET FROM A NON INTERNET AUTHORIZED CLARION DEALER, SHALL NOT BE COVERED BY ANY CLARION LIMITED WARRANTY TO THE EXTENT ALLOWED BY APPLICABLE LAW. IN THE EVENT AND TO THE EXTENT APPLICABLE LAW PROHIBITS ELIMINATION OF WARRANTIES UNDER THESE CIRCUMSTANCES, THE APPLICABLE LIMITED WARRANTY PERIOD SHALL BE DEEMED TO BE FIFTEEN (15) DAYS FROM THE DATE OF ORIGINAL PURCHASE.**
- ALL IMPLIED WARRANTIES EXCEPT TO THE EXTENT PROHIBITED BY APPLICABLE LAW SHALL HAVE NO GREATER DURATION THAN THE WARRANTY PERIOD SET FORTH ABOVE. UNDER NO CIRCUMSTANCES SHALL CLARION BE LIABLE FOR ANY LOSS OR DAMAGE, DIRECT OR CONSEQUENTIAL, ARISING OUT OF THE USE OR INABILITY TO USE THE PRODUCT. BECAUSE SOME STATES DO NOT ALLOW LIMITATIONS ON HOW LONG AN IMPLIED WARRANTY LASTS OR EXCLUSIONS OR LIMITATIONS OF INCIDENTAL OR CONSEQUENTIAL DAMAGES, THE ABOVE LIMITATIONS OR EXCLUSIONS MAY NOT APPLY TO YOU.
- 9. THIS LIMITED WARRANTY GIVES YOU SPECIFIC LEGAL RIGHTS, AND YOU MAY ALSO HAVE OTHER RIGHTS WHICH VARY FROM STATE TO STATE.**
- The laws of the State of California shall govern and control this limited warranty, its interpretation and enforcement.
- Should you have any difficulties with the performance of this product during the warranty period, please call or visit our web site for a listing of Authorized Warranty Service Centers in your area. You may also contact the Clarion Customer Service at the address listed below for any service help you may need with Clarion products.

In USA:
Clarion Corporation of America
Attn:Customer Service Manager
661 W. Redondo Beach Blvd
Gardena, CA.90247-4201
1-800-GO-CLARION
(310)327-9100
www.clarion.com

In Canada:
Clarion Canada Inc.
Warranty Service Center
2239 Winston Park Drive
Oakville,Ontario L6H 5R1
(905)829-4600
www.clarioncanada.com

Free Manuals Download Website

<http://myh66.com>

<http://usermanuals.us>

<http://www.somanuals.com>

<http://www.4manuals.cc>

<http://www.manual-lib.com>

<http://www.404manual.com>

<http://www.luxmanual.com>

<http://aubethermostatmanual.com>

Golf course search by state

<http://golfingnear.com>

Email search by domain

<http://emailbydomain.com>

Auto manuals search

<http://auto.somanuals.com>

TV manuals search

<http://tv.somanuals.com>