



# ECLIPSE<sup>®</sup>

by FUJITSU TEN

## AVN2454

6.5" Wide TFT Touch-Panel Display  
CD/DVD Multi-Source Receiver with DVD NAVIGATION

### OWNER'S MANUAL / Audio

The background of the lower half of the page is a complex, abstract graphic. It features several concentric circles of varying sizes, some solid and some dashed. Overlaid on these are vertical and horizontal lines, some straight and some jagged, resembling a digital or circuit board pattern. The overall effect is a sense of motion and technology.

We appreciate your purchase of this product.  
Please read through this manual for correct operation.  
We suggest that after reading it you keep this manual  
in a safe place for future reference.

Warnings and caution signs, illustrated below, are posted throughout this manual as well as on the AVN2454. They show safe and correct ways to handle the product so as to prevent personal injury to you and others and avoid damage to property.

Before reading through the manual, take time to read through and learn the important information listed in this section.

## Cautions for use

\* The illustrations of screens shown in this manual may differ from the actual screens of the product.



### Warning

This sign indicates a situation in which incorrect handling through disregard of a sign might result in death or serious personal injury.



### Caution

This sign indicates a situation in which incorrect handling through disregard of a sign might result in personal injury or may result solely in damage to property.

The symbol shown below indicates that you should know about the information in order to carefully follow it or you should remember the information for its helpfulness.



A point it will be helpful to remember.

A point you should know about.

- \* Please read all materials such as manuals and warranties that have come with the product. Fujitsu Ten will not be responsible for unsatisfactory product performance due to failure to follow these instructions.
- \* Changes to product specifications may result in differences between content of the manual and features of the product.

**Please use care in handling the manual. Forcefully spreading or pulling on pages may result in their falling out of the binding. Use the manual carefully.**

---

# Table of Contents

---

## Introduction

<i>How to use this manual</i> .....	<b>8</b>
<i>Features</i> .....	<b>10</b>
<i>Before using the deck</i> .....	<b>12</b>
About discs .....	14
About the LCD panel .....	16

## Basic operation

<i>Switching the mode</i> .....	<b>18</b>
Switching the mode .....	18
Displaying operation screen .....	18
<i>Operation screen of each mode</i> .....	<b>19</b>
<i>Adjusting the volume</i> .....	<b>20</b>
Adjusting main volume .....	20
<i>Adjusting sound quality</i> .....	<b>21</b>
Setting DSP (acoustics) .....	22
DSP mode setting .....	22
Adjusting, saving DSP (acoustics) .....	22
Resetting DSP (acoustics) levels .....	23
Adjusting EQ (equalizer) .....	23
Setting sound quality .....	23
Manually setting EQ curves .....	24
Resetting EQ curves .....	24
Setting POS (position selector) .....	25
Setting the position .....	25
Adjusting volume balance .....	26
Setting the BEEP tone .....	27
Muting sound .....	27
Setting auto LOUDNESS .....	27
Setting subwoofer .....	28
<i>Setting background screen</i> .....	<b>29</b>
Setting the wallpaper .....	29
Changing the wallpaper .....	29

<b>Adjusting/setting the screen .....</b>	<b>30</b>
Displaying the image adjustment screen .....	30
Setting day screen to display when vehicle lights are on .....	31
Turning off the screen .....	31
Adjusting image quality .....	32
Switching screen mode .....	32

## **How to operate the tuner**

---

<b>How to use the radio .....</b>	<b>34</b>
Listening to tuner .....	34
Selecting radio stations .....	34
Manual selection .....	34
Automatic selection .....	34
Selection using preset switches .....	35
Saving radio stations .....	35
Saving manually .....	35
Saving with AUTO.P .....	35
Changing stations saved by AUTO.P .....	35
Turning off the radio .....	36

## **How to operate the CD player**

---

<b>How to use the CD player .....</b>	<b>38</b>
Listening to a CD .....	38
Selecting a song .....	38
Fast-forwarding/rewinding .....	39
Searching for a song .....	39
Repeating a song .....	39
Playing songs in random order .....	39
Turning off the CD player .....	39

## **How to operate the MP3 player**

---

<b>How to use the MP3 player .....</b>	<b>40</b>
Playing MP3 .....	41
Selecting a music file .....	41
Selecting with file change switch .....	41
Selecting with TUNE/TRACK switch .....	41
Fast-forwarding/rewinding .....	42
Changing display of the current level .....	42
Displaying the current level .....	42

Searching for a music file .....	42
Repeating the same music file .....	43
Playing songs in random order .....	43
About display of file information .....	44
Displaying folder/file names .....	44
Displaying file information .....	44
Turning off the MP3 player .....	44
About MP3 .....	45
Playable MP3 file standards .....	45
ID3 tags .....	45
Media .....	45
Format of discs .....	46
File names .....	47
Multi-sessions .....	47
Playing MP3 .....	47
MP3 playing time display .....	47
Display order for MP3 file/folder names.....	47
Making and playing MP3 files .....	48
Downloading from Internet MP3 music sites.....	48
Converting CD music to MP3 files .....	48
Writing to CD-R.....	48
When playing back CD-R/RW.....	48

## **How to operate the CD Changer operation**

---

<b><i>How to use the CD changer .....</i></b>	<b><i>50</i></b>
Listening to CD .....	50
Selecting a CD .....	50
Fast-forwarding/rewinding .....	50
Selecting a CD .....	51
Searching for a song or CD from all CDs in changer .....	51
Searching for a song.....	51
Searching for a CD .....	51
Repeating a song or CD .....	51
Repeating the current song.....	51
Repeating the current CD .....	51
Playing songs in random order .....	52
Playing songs on current CD in random order.....	52
Playing songs on all CDs in random order.....	52
Turning off the CD player.....	52

# How to operate the DVD player

---

<b><i>Before using the DVD player</i></b> .....	<b>54</b>
DVD video characteristics .....	54
About multiple Languages .....	54
About multiple angles.....	54
About subtitles .....	55
About discs .....	55
About playable discs .....	55
About region codes of playable discs .....	56
About marks displayed on discs .....	56
About DVD disc structures.....	57
About flow of operations .....	58
<b><i>How to use the DVD player</i></b> .....	<b>59</b>
Watching a DVD .....	59
Operating the video.....	60
Playing the video.....	60
Fast Forward/Rewind .....	60
Using panel button .....	60
Fast-forwarding/rewinding using the touch switches .....	60
Pausing the rideo .....	61
Stopping the video .....	61
Turning off the DVD .....	62
Operating the disc menu .....	62
Searching for a desired chapter.....	62
Searching by chapter .....	62
Searching by title number .....	63
Searching by menu number .....	63
Changing the touch switch display.....	63
Turning off the touch switches .....	63
Changing the touch switch display locations .....	65
Switching between screen display and audio .....	65
Switching the video angle .....	65
Switching subtitle languages .....	66
Switching dubbed audio language .....	67
<b><i>Setting the DVD player</i></b> .....	<b>68</b>
Setting the audio language .....	69
inputacode .....	69
Subtitle language setting.....	69
input a code .....	70
Menu language setting.....	70

input a code .....	70
Setting display of multi-angle mark (angle selection mark).....	71
Viewer restriction setting.....	72
Changing video output .....	73
Table of language codes.....	74

## VTR operation

---

<b><i>How to use the VTR.....</i></b>	<b>76</b>
Viewing the VTR .....	76
Turning off the VTR mode.....	76

## How to use the Card remote control

---

<b><i>How to use the Card remote control.....</i></b>	<b>78</b>
Turning the power on/off .....	79
Adjusting the audio volume .....	79
Cutting the volume instantly (muting).....	79
Switching playback modes.....	80
How to play the tuner .....	80
Selecting the FM/AM band.....	80
Selecting a station (manually or automatically).....	80
Selecting preset stations .....	81
How to play CDs .....	82
Switching disc modes .....	82
Advancing to the next track or returning to the beginning of the track being played .....	82
Skipping to the next or previous disc .....	82
Replacing the battery .....	83

## For reference

---

<b><i>Information you should know.....</i></b>	<b>84</b>
If one of these messages appears .....	84
Before asking for repairs .....	85
Products equipped with Dolby Digital .....	86
Products equipped with Macrovision .....	86

<b><i>Glossary .....</i></b>	<b>87</b>
------------------------------	-----------

<b><i>Index by topic</i></b> .....	<b>89</b>
About screen and sound adjustment .....	89
Audio .....	89
About using the radio .....	89
About using the CD player and CD changer .....	90
About using the MP3 player .....	90
DVD / VTR.....	91
About using the DVD player .....	91
About using the VTR.....	92
Other .....	92
When something isn't clear .....	92
<b><i>Index</i></b> .....	<b>93</b>

**The Index by Topic simplifies searches for explanations about individual features. When confused by an operation, use the Index by Topic to search for information about the operation.**



# How to use this manual

## Section title

A title is assigned for each section.

## Item title

A number and title is assigned for each item.

## Operation title

A title is assigned for each operation purpose.

## Detailed operation title

A title is assigned for each detailed operation purpose.

## Operation procedure

Describes the operation. Proceed with the operation as per the numerical order.

• Music operation

## Adjusting sound quality

### Setting DSP (acoustics)

The DSP function reproduces the sensation of various factory set performance environments by adding reverberation to the music being played.

#### DSP mode setting



- 1 Touching the DSP touch switch brings up the acoustics mode screen as shown.

- After making settings, touch **BACK**. The acoustics mode adjustments will be saved and the system will return to the previous operation screen.

Touch switch	DSP Environment	Touch switch	Acoustic mode types
<b>CONCERT</b>	Concert hall	<b>CLUB</b>	Disco, Club
<b>LIVE</b>	Live performance arena	<b>THEATER</b>	Movietheater
<b>CATHEDRAL</b>	Church with echo	<b>OFF</b>	DSP OFF

### Adjusting, saving DSP (acoustics)

The factory set DSP (acoustics) level for each mode can be adjusted to preference and saved.



- 1 Touch **▲** or **▼** at the right of the screen while in the acoustics mode to be adjusted.

- There are five + side and five - side adjustment levels available.

- 2 Touch the switch for the acoustics mode that has been adjusted until a beep is heard.

### Resetting DSP (acoustics) levels

Default settings for the currently adjusted and saved DSP (acoustics) level can be reset.

**1** Touch **OFF** until a beep is heard.

- The acoustics level will be returned to default value.



ATTENTION

- Only **THEATER** has a default value of +5, in order to increase the sound effects of products such as DVD videos.

- When adjusting the level for the currently selected DSP (acoustics) mode, the

### Adjusting EQ (equalizer)

Adjusts sound qualities to preferred characteristics according to the music genre and audio source.

#### Setting sound quality

Each factory set equalizer curve can be selected and adjusted to preference.



**1** Touching the EQ touch switch brings up the equalizer mode screen as shown in the table.

- After making settings, touch **BACK**. The equalizer mode adjustments will be saved and the system will return to the previous operation screen.

Touch switch	Equalizer mode types
<b>FLAT</b>	No EQ correction
<b>EQ1</b>	POPS
<b>EQ2</b>	ROCK
<b>EQ3</b>	JAZZ
<b>EQ4</b>	CLASSIC
<b>EQ5</b>	VOCAL

Go to the next page ➔

**23**

## Attention

Additional points regarding the operations are given here.

## Section side heading

Only the section side heading will appear in dark letters.

## Operation screen

A screen showing the operation will appear.

Go to the next page ➔

The operation procedures are continued on the next page.

# Features

## DVD player with sharp video and dynamic sound (page 54)

Plays DVD video recorded with high quality images and sound.

(DVD media is able to record a movie with high quality video and digital sound that exceeds the quality of CD media.)



## MP3 player for music discs having 1/10 compression (page 40)

Plays CD-R (recordable) discs that have been compiled in MP3 format. (MP3 is a format that enables recording of the songs of several albums onto a single CD-R.)



## DSP effects for simulating acoustics of various performance environments (page 22)

Provides ability to simulate the sensation of various performance environments for matching to the genre and source of a song.



## Selection and display of favorite wallpaper (screen backgrounds)

Wallpaper of your choice can be switched and displayed for use as the background of the information screen and audio playback screens.

The screen from a navigation unit can also be linked and selected.

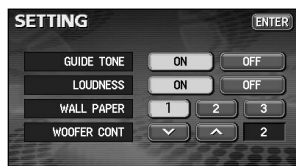

- Setting wallpaper for the information screen and audio operations screen

## System additions

### \* CD changer

A CD changer enables non-stop playing of multiple discs, for convenience at times such as taking a long drive.

It is easy to search for and play a song from among the discs on a changer.

### \* VTR

Connecting a VTR deck enables watching of video tapes.



# Before using the deck

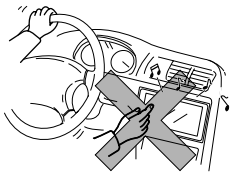

- Be very careful and pay full attention to safety when operating the audio controls while driving, otherwise accidents may occur.

Also be sure to set volume so that you can still adequately hear sounds outside the vehicle.

Improper use can contribute to occurrence of a traffic accident.

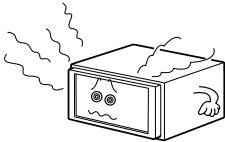

- Never continue to use the system if it is malfunctioning in any way.

If smoke, abnormal noises or abnormal odors are noticed, turn off the power immediately.

Immediately turn off audio in such situations.

Exercise caution as to the temperature inside the vehicle.

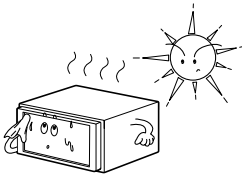

- The temperature inside the vehicle can increase during hot weather. Wait for the temperature inside the vehicle to drop before using the unit.

Otherwise damage may occur.

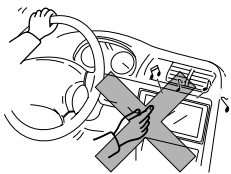

- The driver should avoid operating the system as much as possible while driving.

Improper use can contribute to occurrence of a traffic accident.

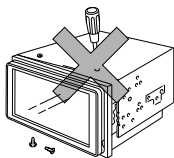

- Do not disassemble or modify the deck.

The deck has a precisely designed structure, so consult your retailer in the event of any unsatisfactory performance.

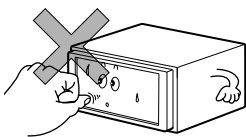

- Do not apply excessive force to the monitor, otherwise it may become damaged.

Otherwise damage may occur.

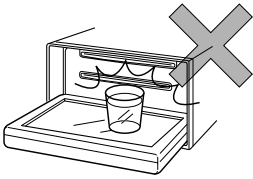

- Do not place items such as cups or cans on top of the monitor, and do not leave the monitor tilted down when not in use, Otherwise damage may occur.

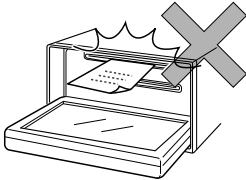

- Do not insert any objects other than discs into the disc slot. Otherwise damage may occur.

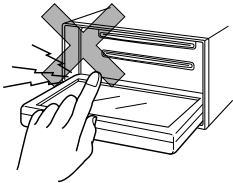

- Be careful not to get fingers or other objects behind monitor when it is being retracted into place. Interference can cause an injury or damage the deck.

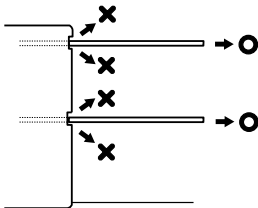

- When removing a disc from the deck, remove it in the horizontally level direction. Do not pull them up forcibly or press down on them strongly while removing them, Improper removal can scratch the disc, cause deck noise or result in other damage.

# Before using the deck

## About discs



- Water droplets can form on the inside of the unit during cold or rainy weather in the same way car windows can fog up. (This is condensation.) When this happens, the audio can jump and playback can stop, so ventilate or dehumidify the vehicle for a short time before operating the equipment.
- To safeguard the components of the player, the unit will automatically stop when a malfunction occurs. If the player will not operate even when messages displayed on the screen are followed, consult with your equipment retailer because it is possible that the unit has been damaged.
- It is possible that the sound will skip if the vehicle experiences violent motion on rough roads.
- It is possible that a CD-R (CD-Recordable) or CD-RW (CD-ReWritable) disc will not play on the unit due to special characteristics, scratches, dirt or deterioration caused by long storage in the vehicle. In addition, a CD-R or CD-RW disc written with CD-R, CD-RW or UDF format that has not been finalized will not play on the unit.
- An audio disc or DVD video disc bearing one the marks on the left can be played.



## About handling discs

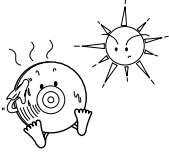

- Be sure to store discs in their cases and keep them out of direct sunlight. Discs can warp and become unusable.

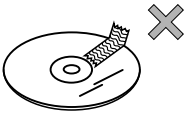

- Do not apply paper-based tape to either the recording side or label side of a disc. Damage could result.



- Do not use discs on which there are cracks or large warps. Damage could result.



- Do not touch the recorded side of a disc when handling it. (This is the side with the rainbow-colored reflection.) The disc may become dirty and that could cause sound jumping.



- Using a disc that has become dirty can scratch the disc and result in sound jumping. Use a commercially available compact disc cleaner to clean a CD, wiping lightly from the center to the edge.

## About new discs

Rough Edges

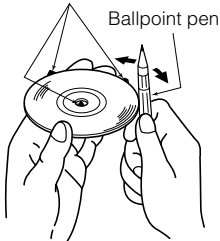

- You may notice that some brand new discs are rough around the center hole or outside edge. Remove the rough edges with the side of a ballpoint pen, etc. Rough edges may prevent proper loading in the unit. Flakes from the rough edges may also stick to the recorded surface and interfere with playback.



# Before using the deck



## About rental discs

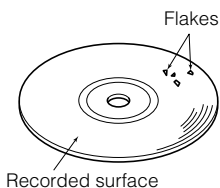

- Do not use CD discs with attached cellophane tape, rental CD discs with glue protruding from labels or discs with the residue of peeled adhesives. Using discs with those conditions can prevent the player from properly opening and closing as well as cause other damage.

## About specially shaped discs

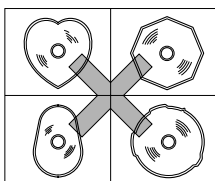

- Specially-shaped or octagonal CDs, like heart-shaped cannot be played. Do not attempt to play them, even with an adapter, since they may damage the player.
- Please do not use a commercially available lens cleaner because it may cause damage to the pickup of the player.

## About disc accessories

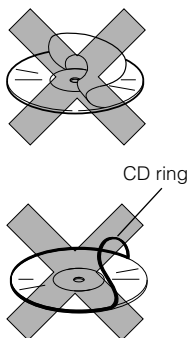

- Do not use accessories (stabilizers, protective seals, laser lens cleaners, etc.) sold for "improving sound performance" or "protecting CDs." The changes in CD thickness or outside dimensions made by these accessories may cause problems in the player.
- Please be sure NOT to attach any ring-shape protector (or other accessory) to your discs. Those protectors are commercially available and said to protect disc and to improve sound quality (and antivibration effect), but they can do more harm than good in regular uses. The most common problems are insert/Eject related problems and "No playback" problems due to the protector ring that come off in the disc mechanism.

## About the LCD panel



- The LCD panel can appear to be white or black when seen from certain angles.
- The screen will be difficult to read when external light such as sunlight falls on the display.

# MEMO



## Switching the mode

The deck can be used when the vehicle's ignition switch is on or in the ACC position.

- This deck supports use of a remote control. The card remote control is sold separately and can be purchased at your local retailer. Refer to page 78 for instructions on operation of the remote control.

### Switching the mode

- 1 Press **SOURCE** and then touch the touch switch for any of the audio modes, and the screen will change to that audio mode.

- When the navigation screen is being displayed before pressing **SOURCE**, the selected mode will be displayed on-screen over the background.

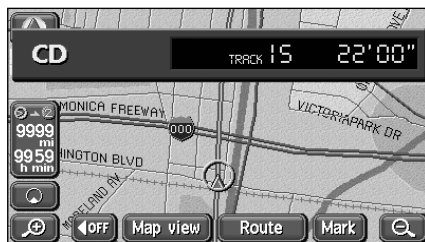

- On-screen display

### Displaying operation screen

- 1 Press **CONT.**



# Operation screen of each mode

The operation screen for each mode will appear as shown below.

- AM radio operation screen



- FM radio operation screen

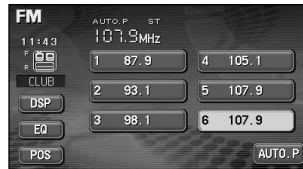

- CD player operation screen



- MP3 player operation screen



- DVD player operation screen



- CD changer operation screen (optional)



- VTR operation screen(optional)



When the operation screen for DVD or video (VTR) has not been operated for 6 seconds or more, the operation screen will automatically be cancelled.

# Adjusting the volume

## Adjusting main volume

**1** Press the VOLUME switch.

Pressing **+** will increase volume.

Pressing **-** will decrease volume.

- Each press of the switch will change the volume by two steps. When the volume reaches 50 or higher, the switch will change the volume by one step. Holding the switch will continue to change the volume.

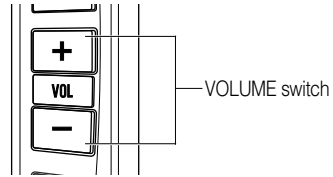

# Adjusting sound quality

To adjust sound quality, touch the DSP, EQ or POS switch while the operation screen for a mode is displayed. Adjustments made in any mode will be saved and applied to all modes.

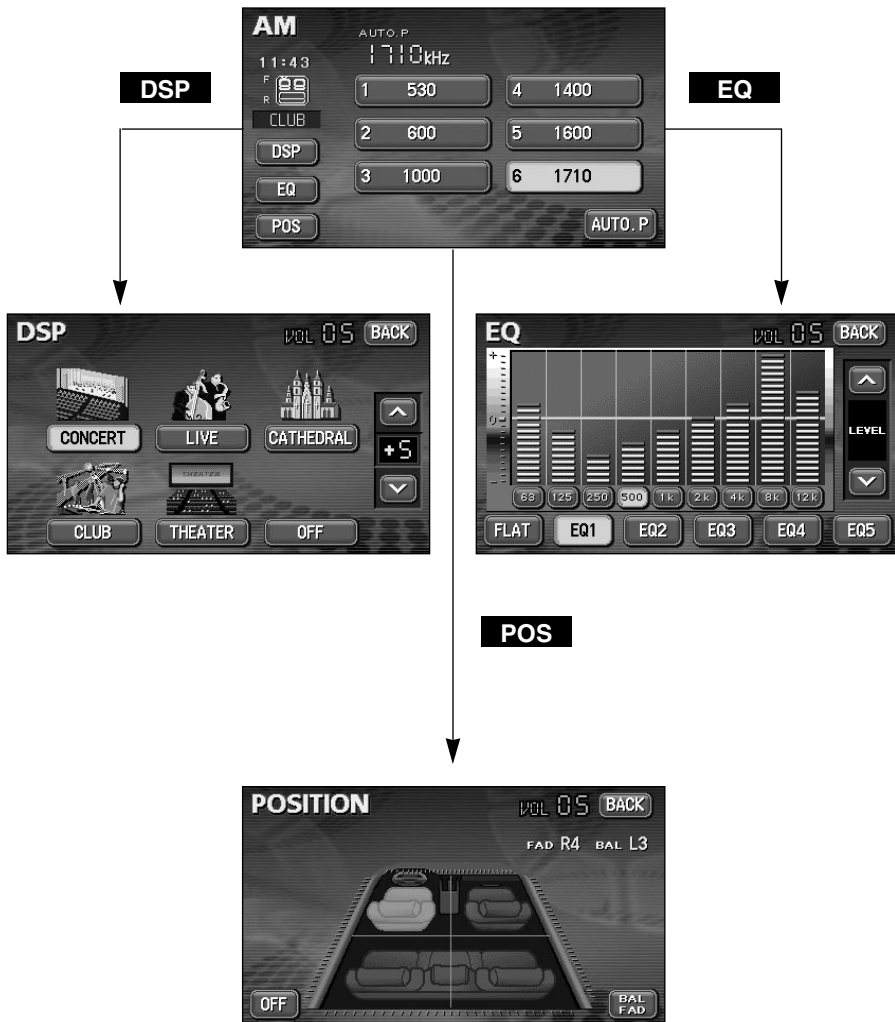

When in DVD mode, touching **SET** of the operation screen will display the touch switches for adjusting sound quality.

# Adjusting sound quality

## Setting DSP (acoustics)

The DSP function reproduces the sensation of various factory set performance environments by adding reverberation to the music being played.

### DSP mode setting

- 1 Touching the DSP touch switch brings up the acoustics mode screen as shown.

- After making settings, touch **BACK**. The acoustics mode adjustments will be saved and the system will return to the previous operation screen.



Touch switch	DSP Environment	Touch switch	Acoustic mode types
<b>CONCERT</b>	Concert hall	<b>CLUB</b>	Disco, Club
<b>LIVE</b>	Live performance arena	<b>THEATER</b>	Movietheater
<b>CATHEDRAL</b>	Church with echo	<b>OFF</b>	DSP OFF

### Adjusting, saving DSP (acoustics)

The factory set DSP (acoustics) level for each mode can be adjusted to preference and saved.

- 1 Touch **▲** or **▼** at the right of the screen while in the acoustics mode to be adjusted.
  - There are five + side and five - side adjustment levels available.
- 2 Touch the switch for the acoustics mode that has been adjusted until a beep is heard.

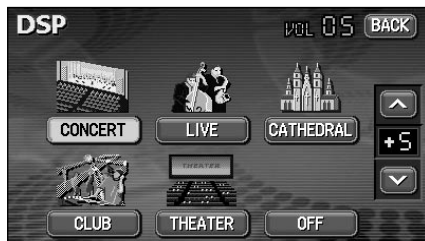

## Resetting DSP (acoustics) levels

Default settings for the currently adjusted and saved DSP (acoustics) level can be reset.

**1** Touch **OFF** until a beep is heard.

- The acoustics level will be returned to default value.



•Only **THEATER** has a default value of +5, in order to increase the sound effects of products such as DVD videos.

•When adjusting the level for the currently selected DSP (acoustics) mode, the level will not be saved for other acoustics modes.

## Adjusting EQ (equalizer)

Adjusts sound quality to preferred characteristics according to the music genre and audio source.

### Setting sound quality

Each factory set equalizer curve can be selected and adjusted to preference.

**1** Touching the EQ touch switch brings up the equalizer mode screen as shown in the table.

- After making settings, touch **BACK**. The equalizer mode adjustments will be saved and the system will return to the previous operation screen.

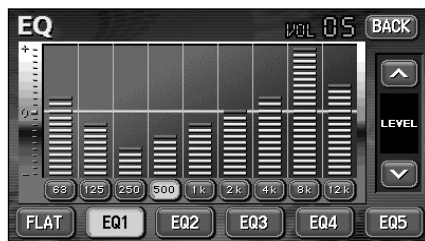

Touch switch	Equalizer mode types
<b>FLAT</b>	No EQ correction
<b>EQ1</b>	POPS
<b>EQ2</b>	ROCK
<b>EQ3</b>	JAZZ
<b>EQ4</b>	CLASSIC
<b>EQ5</b>	VOCAL



# Adjusting sound quality

## Manually setting EQ curves

Each factory set equalizer curve can be set to a preferred curve.

- 1 Touch the screen and slowly draw the image of the preferred equalizer curve with your finger.
- 2 To make fine adjustments, touch the switch for the frequency to be adjusted.
- 3 Touch **▲** or **▼** at the right of the screen to adjust.
- 4 Choose from touch switches **EQ1** to **EQ5** for saving the settings and then touch and hold the switch until a beep is heard.

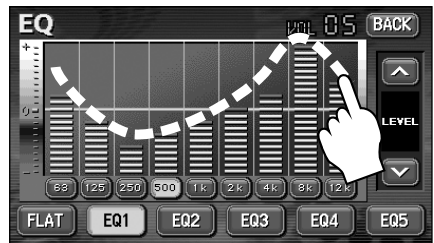

- The saved equalizer curve can be used for other settings.
- After making settings, touch **BACK**. The equalizer mode adjustments will be saved and the system will return to the previous operation screen.

## Resetting EQ curves

Currently saved equalizer curves and factory set equalizer curves can be returned to the default values.

- 1 Touch **FLAT** until a beep is heard.
  - The equalizer curve will be reset to default values.

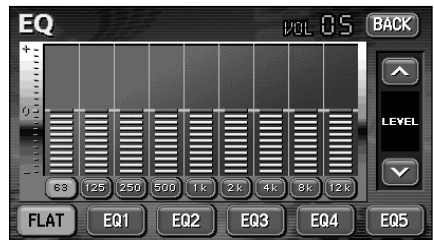

## Setting POS (position selector)

The stereophonic position for obtaining optimum acoustic effects can be adjusted to match the number and position of passengers. In addition, front-to-back, right-to-left volume balance can be adjusted for the selected position.

### Setting the position

**1** Touching the image of a seat shown on the **POS** setting screen will change the position.

- The selected position will change its color to orange. Touching the seat again will cancel the selection. The four positions shown by the table below can be set.
- Touching **OFF** will cancel all settings.
- After making settings, touch **BACK**. The position will be saved and the system will return to the previous operation screen.

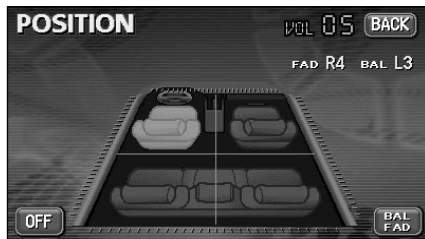

Display	Position	Display	Position
	Acoustics optimized for driver's seat		Acoustics optimized for both front seats
	Acoustics optimized for passenger's seat		Acoustics optimized for rear seats



This product is configured for vehicles with a left-side driver's position.

# Adjusting sound quality

## Adjusting volume balance

The set position for front-to-back, right-to-left volume balance can be adjusted.

- 1 Touch **BAL • FAD** on the POSITION setting screen to display the volume balance adjustment screen.

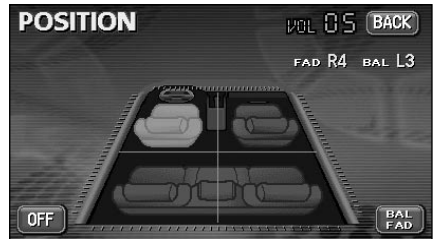

- 2 Touch the screen at the preferred balance point.

- To make fine adjustments, touch **▲**, **▼**, **<**, **>**.
- Touching **CENTER** will set the volume balance to the center position.
- After making settings, touch **BACK**.

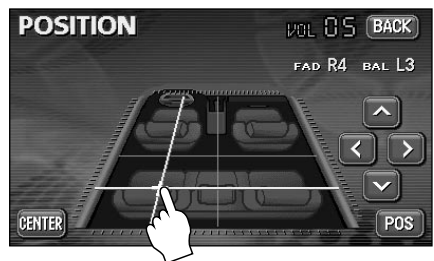

- The set volume balance will be saved and the system will return to the previous operation screen.
- To set the position again, touch **POS** and repeat the steps above.
- Adjustments to volume balance and position are saved separately. Activating each position and then displaying volume balance adjustment screen will show the volume balance for each position.

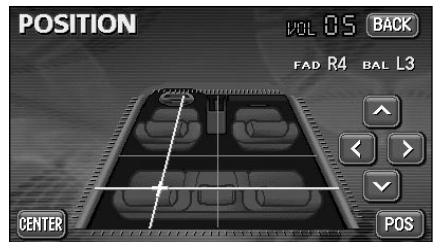

Touching and holding **▲**, **▼**, **<** or **>** while making fine adjustments will adjust values in a continuous action. However, adjustment will lock when it reaches the center value, and **▲**, **▼**, **<** or **>** must be pressed again to continue adjustment.

## Setting the BEEP tone

The guide tone that is emitted when touching a panel switch or touch switch can be set to on or off.

**1** Touch **SETTING** on the INFORMATION screen.

**2** Touch **ON** or **OFF** of GUIDE TONE.

- The pressed touch switch will become green.
- Touching **OFF** will cancel (turn off) the guide tone.

**3** Touch **ENTER**.

## Muting sound

Sound from the audio system can be temporarily muted.

**1** Press the **MUTE** switch.

- Volume will become "0".
- Pressing **MUTE** again will return to previous volume.
- The VOLUME display will flash during mute.

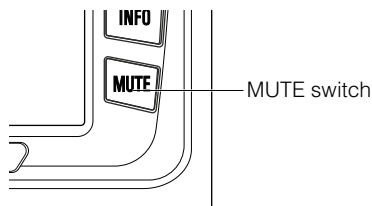

## Setting auto LOUDNESS

Audio can be modulated to correct for insufficient low and high sounds when listening at low volume.

**1** Touch **SETTING** on the INFORMATION screen.

**2** Touch **ON** or **OFF** of LOUDNESS.

- The pressed touch switch will become the selection color.

**3** Touch **ENTER**.

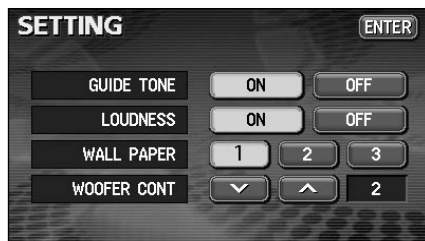

# Adjusting sound quality

## Setting subwoofer

When a woofer is connected, the preferred output level for audio can be set.

- 1 Touch **SETTING** on the INFORMATION screen.
- 2 Touch **▲** or **▼** of WOOFER CONT.
- 3 Touch **ENTER**.

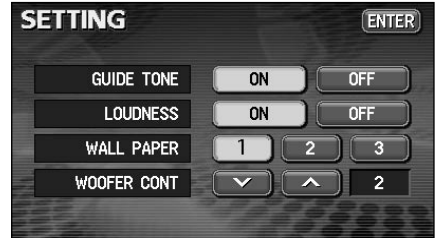

# Setting background screen

The background for the audio screen, information screen and navigation screen can be changed to a preferred wallpaper.

## Setting the wallpaper

### Changing the wallpaper

- 1 Press **INFO** to display the INFORMATION screen.
- 2 Touch **SETTING**.
- 3 Touch **1**, **2** or **3** of WALL PAPER.
  - The pressed touch switch will become green and the wallpaper (background) will change.
- 4 Touch **ENTER**.

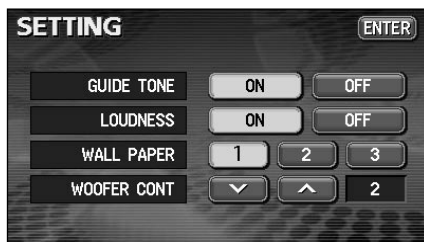

# Adjusting/setting the screen

Quality adjustments can be made for the images such as the audio operation screen, navigation screen and DVD or VTR (optional).

## Displaying the image adjustment screen

Contrast, brightness and other picture settings can be adjusted to match preferences for viewing DVD video or the audio operation screen.

To make viewing easier, the display switches between day screen/night screen according to whether the vehicle lights (parking lights, taillights, license plate lights) are on/off.

(Default settings)

- When vehicle lights are on: [Night screen displayed]
- When vehicle lights are off: [Day screen displayed]

[Audio operation screen]



- Day display [Vehicle lights are off]



- Night display [Vehicle lights are on]

[DVD/VTR Screen]



- Day display [Vehicle lights are off]



- Night display [Vehicle lights are on]

1 Press **DISP** on the audio mode screen or DVD/VTR screen.

2 Touch **ENTER** after making any adjustments.

- If no adjustments are made after 20 or more seconds, the image quality adjustment screen will be cancelled.



- When adjusting audio operation screen



- When adjusting DVD/VTR screen

### Setting day screen to display when vehicle lights are on

1 The day screen and night screen will be switched each time **DAY** is pressed.

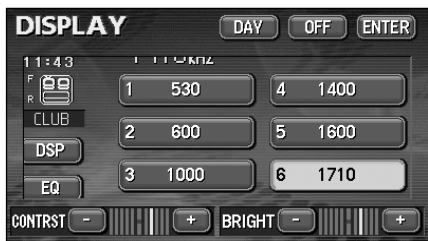

- When adjusting audio operation screen



- When adjusting DVD/VTR screen

### Turning off the screen

1 Touch **OFF**.

- Press **CONT** or **NAVI** to return to the original screen.



# Adjusting/setting the screen

## Adjusting image quality

The day screen and night screen can be separately adjusted.



- When adjusting audio operation screen or navigation screen

CONTRST

- 1 Touch **+** to strengthen contrast, **-** to weaken contrast.

BRIGHT

- 1 Touch **+** to make lighter, **-** to make darker.

COLOR (for DVD/VTR screen only)

- 1 Touch **+** to strengthen green color, **-** to strengthen red color.

TINT (for DVD/VTR screen only)

- 1 Touch **+** to make tint darker, **-** to make tint lighter.



- When adjusting DVD/VTR screen

## Switching screen mode

- 1 Touch **WIDE** on DVD or VTR operation screen.

- 2 Touch **NORMAL**, **WIDE1**, **WIDE2** or **WIDE3**.

•This selects the wide mode.

- 3 Touch **BACK**.

•Returns to the DVD or VTR operation screen.

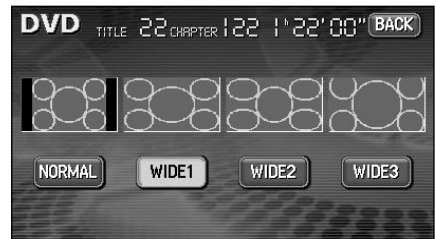



NORMAL mode

The screen is shown with vertical to horizontal ratio of 3 to 4 (normal TV screen size) and side edges are black.



WIDE 1 mode

The screen for vertical to horizontal ratio of 3 to 4 (normal TV screen size) is uniformly expanded in the left and right directions.

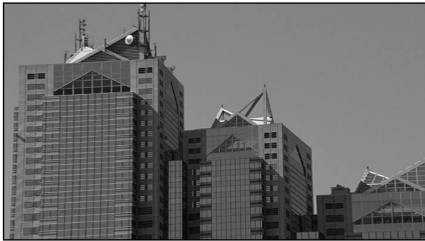

WIDE 2 mode

The screen for vertical to horizontal ratio of 3 to 4 (normal TV screen size) is uniformly expanded in the left and right directions (except for the central section of the screen).



WIDE 3 mode

The screen for vertical to horizontal ratio of 3 to 4 (normal TV screen size) is uniformly expanded in the upward, downward, left and right directions.



Viewing of wide screen modes is permitted when limited to the personal entertainment of the user, but caution is needed because using technologies such as image compression and expansion for the purpose of commercial benefit or public presentation may infringe upon the rights of the copyright holder being protected by applicable copyright law.

# How to use the radio

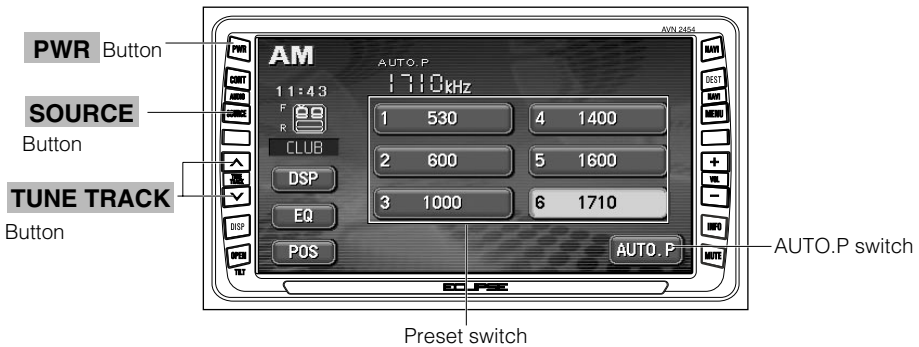

## Listening to tuner

- 1 Press **SOURCE**.
- 2 Touch **AM** for AM or **FM** for FM.

## Selecting radio stations

### Manual selection

- 1 Press **▲** or **▼**.
  - Each pressing of the switch moves the frequency one step up or down. (One step on the AM band is 10kHz. One step on the FM band is 0.2MHz.)
  - ▲** (up switch): Raises frequency
  - ▼** (down switch): Lowers frequency

### Automatic selection

- 1 Press and hold the **▲** or **▼** switch until a beep is heard.

The station that is closest in frequency to the frequency that is currently displayed on the screen will be searched for automatically, and searching will stop when the station is received. To stop the search before a station is found, press the button again.

## Selection using preset switches

1 Touch the preset switch that already has a station recorded.

- Refer to "Saving radio stations" (on next page) for details on saving stations.



If the reception for a particular station is weak in the area you are in, automatic selection may not work.

## Saving radio stations

There are two modes for saving radio stations, manual and AUTO.P, and these modes operate independently.

### Saving manually

Confirm that "AUTO.P" is not displayed in the upper part of the screen.

- If "AUTO.P" is displayed, touching **AUTO.P** will switch the screen to manual.

1 Use manual tuning or automatic tuning to select the station to be saved.

2 Choose a preset switch and touch it until a beep is heard.

- The radio station (frequency) is set. Touching the preset switch will now tune in the selected station.

### Saving with AUTO.P

1 Touch **AUTO.P** until a beep is heard.

- The AUTO.P function will activate and start automatically selecting stations. A beep will be heard when automatic selection of stations is completed. Touching **AUTO.P** again will delete all saved stations and new stations will be saved.

### Changing stations saved by AUTO.P

1 Use manual tuning or automatic tuning to select the station to be saved.

2 Choose a preset switch and touch it until a beep is heard.

# How to use the radio

## About AUTO.P

Because AUTO.P temporarily saves stations for the preset switches, stations saved manually will remain in memory even if AUTO.P is used. By manually saving stations that are used regularly, these manually saved stations can be restored even after AUTO.P has been used, such as after traveling.

Touching **AUTO.P** while AUTO.P is being used or after AUTO.P has been used will return the preset memories back to the condition they had before AUTO.P was used. (Doing so will delete the stations saved with AUTO.P.) The flow for switching from AUTO.P to manual is shown below.

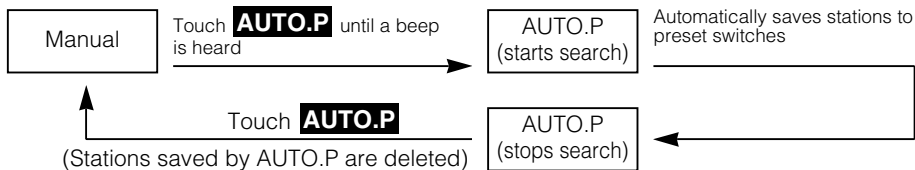

ATTENTION

- AUTO.P may not automatically receive stations if radio waves in the surrounding area are weak.
- A station saved by the tuning switch may not match a station saved by AUTO.P even though the signal is received from the same station.
- Due to conditions for receiving radio waves, saved stations may differ even when the AUTO.P switch is operated repeatedly in the same location.
- Up to six stations having good reception sensitivity are automatically saved in order starting from the lowest frequency.
- When less than six stations capable of reception are found, nothing is saved for the remaining preset switches.

## Turning off the radio

1 Press **PWR**.

- Pressing **PWR** again will turn on the radio and resume reception of the radio station (frequency) received before power was turned off.

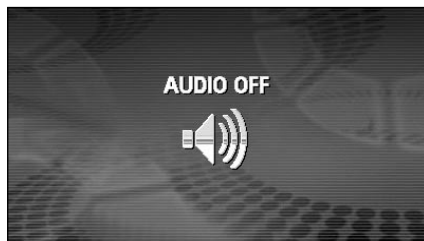

# MEMO



# How to use the CD player

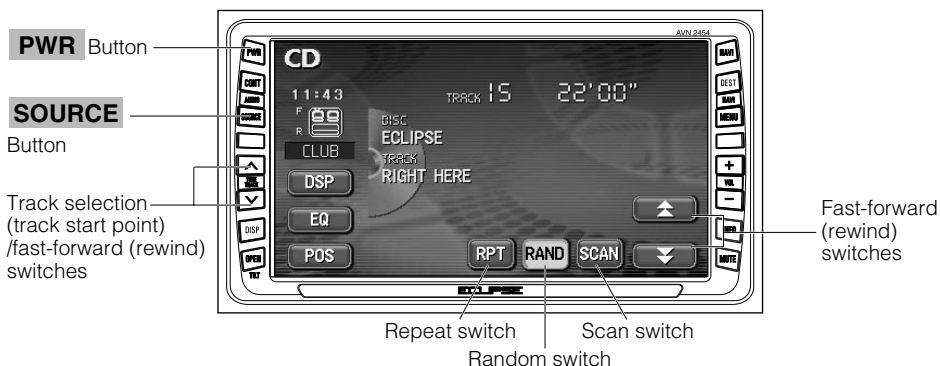

## Listening to a CD

Start playback by inserting a CD into the disc insertion slot.

**1** Press **SOURCE** while a CD is inserted.

**2** Touch **CD**.

•Playback will begin.

## Selecting a song

You can jump to the opening of a song you want to hear.

**1** Press **▲** or **▼**.

- **▲** (up): Selects next song
- **▼** (down): Selects previous song

Press **▲** to move to the song after the song currently being played, and press **▼** to move to the song before the song being played. The currently selected track number will be shown in the display.



- Titles and song names can be displayed when they are recorded on a CD. Up to 32 characters can be shown in the display.
- Only characters recorded by ASCII code can be shown on the CD-TEXT display.
- The CD-TEXT display may not be able to show characters for discs recorded with many title characters.

## Fast-forwarding/rewinding

It is possible to fast-forward/rewind in the song being played.

**1** Press **▲** or **▼** until a beep is heard, or touch and hold **▲** or **▼**.

- **▲** or **▲** (up): Fast-forwards
- **▼** or **▼** (down): Rewinds

The deck switches to the fast-forward (rewind) mode when the beep is heard and will continue fast-forwarding (rewinding) until your finger is removed from the switch.

## Searching for a song

**1** Touch **SCAN**.

- The deck will play the first 10 seconds of each song. Touching **SCAN** again will continue playing the current song.

## Repeating a song

**1** Touch **RPT**.

- Touching **RPT** once will cause repeating of the song until the function is cancelled. Touching **RPT** again will cancel repeating of the song.

## Playing songs in random order

**1** Touch **RAND**.

- Touching **RAND** will play songs in random order until the function is cancelled. Touching **RAND** again will cancel random playing of songs.
- The song to be played next is randomly selected at the end of current song, so it is possible that a single song could end up being played twice in a row.

## Turning off the CD player

**1** Press **PWR**.

- Pressing **PWR** again will start playing.



# How to use the MP3 player

For safety considerations, some functions are disabled while the vehicle is in motion.

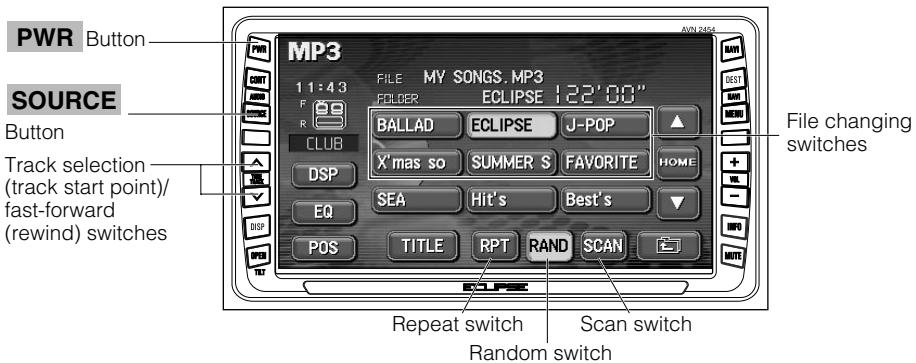

## Example of MP3 file structure

Explanations are based on this example of MP3 file structure.

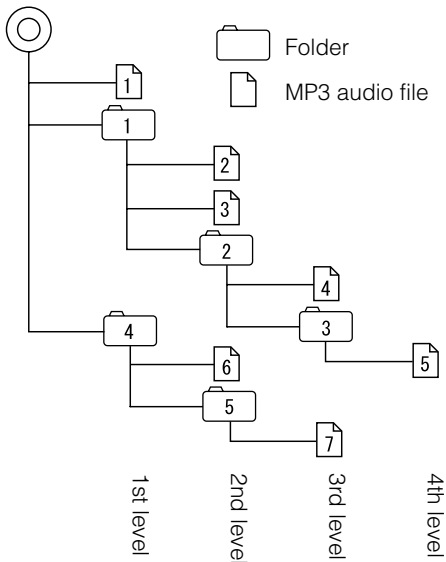







## Playing MP3

Start playback by inserting a CD into the disc insertion slot, which will automatically turn on power.

**1** Press **SOURCE** while a disc is inserted.

**2** Touch **MP3**.



- Playback will begin.
- The CD player screen will be shown for about 2 seconds as the system checks whether the inserted CD is a music CD or an MP3 disc.
- Normally, tracks are played back in the order        .  
When multiple MP3 files and folders are on the same level, they are played in ascending order by folder and file names.

## Selecting a music file

A music file located within a folder can be selected.

### Selecting with file change switch

**1** Touch the music file.

- The currently selected file name and folder name will be shown in the display.
- When more than 9 music files are located in the same folder, touching  or  can switch between the data. (This function is not available when the vehicle is in motion.)

### Selecting with TUNE/TRACK switch

When several music files are located in the same folder, the next music file or previous music file can be selected with the track selection (track start point)

**1** Press **▲** or **▼**.

- **▲** (up): Selects next music file
- **▼** (down): Selects previous music file



- When music data and MP3 data have been recorded on the same disc, they may not be played.
- When MP3 is being played, navigation operation will become slower. This is not a malfunction of the system.
- The following operations are based on the example MP3 file structure given above.

# How to use the MP3 player

---

## Fast-forwarding/rewinding

It is possible to fast-forward/rewind in the song being played.

**1** Press **▲** or **▼** until a beep is heard.

- **▲** (up): Fast-forwards
- **▼** (down): Rewinds

The deck switches to the fast-forward (rewind) mode when the beep is heard and will continue fast-forwarding (rewinding) until your finger is removed from the switch.

## Changing display of the current level

The folder level can be switched and displayed.

**1** Touch  or **HOME**.

- : Displays the next higher folder level.
- **HOME**: Displays the level of the file currently being played.

## Displaying the current level

Displays the file currently being played.

**1** Touch **HOME**.

## Searching for a music file

**1** Touch **SCAN**.

- The system will play the first 10 seconds of each song located within the same layer of the folder currently being played. Touching **SCAN** again will continue playing the current song.

## Repeating the same music file

### 1 Touch **RPT**.

- The file currently being played will be repeated.
- Setting **RPT** will cause repeating of the song until the function is cancelled. Touching **RPT** again will cancel repeating of the song.







## Playing songs in random order

### 1 Touch **RAND**.

- Files will be randomly selected from among all files at the same level as the folder currently being played.
- Touching **RAND** will play songs in random order until the function is cancelled. Touching **RAND** again will cancel random playing of songs.
- Touching **RPT** while the random function is operating will repeat the currently playing song. Touching **RPT** again will return to random playing of songs.
- The song to be played next is randomly selected at the end of current song, so it is possible that a single song could end up being played twice in a row.



Refer to page 40 for an example of MP3 file structure.

When the display shows the folder and files of the second level (  ,  and  ) as  of the third level is being played, touching **HOME** will show the folder and files of the third level (  and  ).

# How to use the MP3 player

## About display of file information

Folder names and file information (album name and song titles) recorded on the disc can be displayed.

The number of characters that can be displayed is as shown below.

Screen Display	
Folder/file names	Music file information
8 characters max.	32 characters max.

### Displaying folder/file names

- 1 Press **CONT** to display the operation screen.



### Displaying file information

- 1 Touch **TITLE**.

- The **TITLE** switch will change to **TITLE OFF** while file information is being displayed. Touching **TITLE OFF** will change the display to a folder/file switch.



## Turning off the MP3 player

- 1 Press **PWR**.

- Pressing **PWR** again will start playing.

## About MP3

MP3 (MPEG-1 Audio Layer III) is a standard format for audio compression technology. By using MP3, a file can be compressed to one-tenth the size of the original.

This unit has limitations on MP3 file standards and recorded media and formats that can be used. Be aware of the following points when recording MP3 files.

### *Playable MP3 file standards*

- Supported standards: MPEG-1 Audio Layer III
- Supported sampling frequencies: 32, 44.1, 48 (kHz)
- Supported bit rate: 32, 40, 48, 56, 64, 80, 96, 112, 128 (kbps)
  - \*Supports VBR.
  - \* Does not support free format.
  - \* Bit rates vary for MPEG-1 and MPEG-2.
- Supported channel modes: stereo, joint stereo, dual channel, monaural



Use 128kbps or lower for the MP3 bit rate. If the bit rate exceeds 128kbps, there may be sound jumping during MP3 playback.

### *ID3 tags*

MP3 files have an "ID3 Tag" that allows input of information so that data such as song title and artist can be saved.

This unit supports ID3v.1.0 and ID3v.1.1 tags. Use only ASCII code to record tags, since only ASCII code is supported by this deck. Recording of characters not included in ASCII code will result in display of garbled characters.

### *Media*

Media capable of playing MP3 includes CD-ROM, CD-R and CD-RW discs. Compared to CD-ROM media commonly used for music discs, CD-R discs are fragile in high temperature/high humidity environments and one section of the CD-R may become incapable of playback.

Fingerprints or scratches on the disc may prevent playback or cause skipping during playback. Sections of a CD-R may deteriorate if left inside a vehicle for long periods of time. It is also recommended that CD-R discs be kept in a light-blocking case because the discs are vulnerable to ultra-violet light.

# How to use the MP3 player

## Format of discs

The format of discs to be used must be ISO9660 Level 1 or Level 2.

Control items for this standard are as follows:

Also be sure to use "MODE 1" for recording. Discs recorded with "MODE 2" are not supported.

MP3 files recorded in a format other than the one explained above may result in files that cannot be played normally and in file names and folder names that do not display properly.

Limitations in addition to standards are as follows.

- Maximum directory layers: 8 layers
- Maximum characters for folder names/file names: 31 (including "." and 3 letter file extension)
- Allowable characters for folder names/file names: A~Z, 0~9, \_ (underscore)
- Number of files/folders possible on a single disc: 512
- Each file that is not an MP3 file (files with extensions other than "MP3") is also counted as a file.

### [Configuration example for CD supporting MP3]

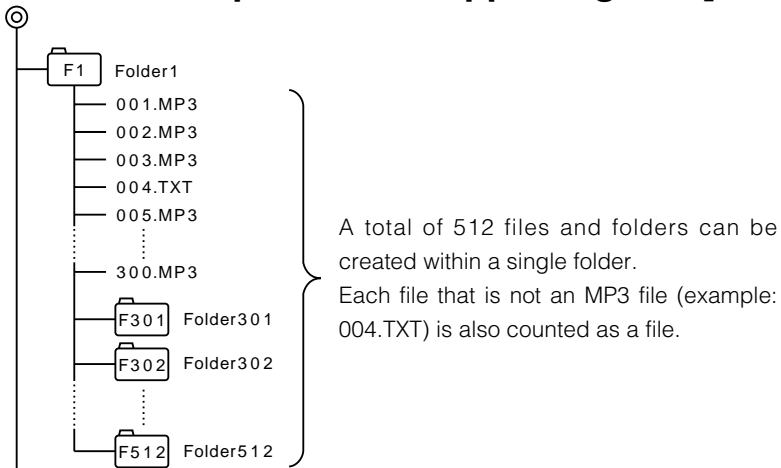

- A total of 1023 files and folders can be recorded on a single disc.

## File names

Only files with the MP3 file extension ".mp3" can be recognized as MP3 and played. Be sure to save MP3 files with the ".mp3" file extension.

Use half-width English capital letters to write "MP" of the extension.

## Multi-sessions

Multisessions are supported and CD-R/RW with recorded MP3 files can be played. When written with "Track at once", however, finalize the disc with session close or write protect.

## Playing MP3

When a disc having MP3 files recorded on it is inserted into the deck, the system first checks all the files on the disc. The check will be completed within approximately 10 seconds after the disc is inserted, and the first MP3 file will begin playing. If the check is not completed within approximately 10 seconds, the music or audio previously being played is continuing, but playing of the MP3 files may be started by touching **MP3**. Sound is not emitted from the system while it is checking the files on the disc.

In order to speed up completion of the file check, it is recommended that you avoid recording files that are not MP3 files and avoid establishing unnecessary folders.

In addition, it is recommended that you record all data in a single session because a multisession disc takes time for CD control information acquisition.

When MP3 is being played, navigation operation will become slower. This is not a malfunction of the system.

## MP3 playing time display

It is possible that playing time will not be correct, depending on the writing condition of the MP3 file.

\* It is possible that playing time will not be correct when VBR Fast Up/Down is operated.

## Display order of MP3 file/folder names

Names of MP3 folders and files within the same level are displayed in the following order.

1. MP3 files displayed first, by ascending order of numbers, letters.
2. Folders displayed next, by ascending order of numbers, letters.



If the ".mp3" file extension is attached to a file other than an MP3 file, that file will be mistakenly recognized by the unit as an MP3 file and played, resulting in loud noise output that can damage the speakers. Be sure to avoid attaching the ".mp3" file extension to files that are not MP3 files.



# How to use the MP3 player

## Making and playing MP3 files

MP3 files created by recording broadcasts, records, audio recordings, video recordings or live performances cannot be used for purposes other than personal entertainment without permission of the copyright holder as set forth in copyright law.

### *Downloading from Internet MP3 music sites*

There are many kinds of sites that distribute MP3 files on the Internet, such as "pay per download" online shopping sites, "try before you buy" listening sites and free download sites. Follow the rules for each site (such as paying fees) and download according to site instructions.

### *Converting CD music to MP3 files*

Prepare a computer with commercially available MP3 encoding software (conversion software). (Some encoding programs available on the Internet do not require payment.) Music data files in MP3 format can be made by inserting the music CD into the CD-ROM drive of the computer and following the procedures of the MP3 encoding software to compress the songs of the music CD. A 12cm music CD (having a maximum of 74 minutes of recording/650MB of data) can be compressed to 65MB (about 1/10 of the original size).

### *Writing to CD-R*

MP3 files can be recorded on CD-R/RW by using a CD-R/RW drive connected to a computer. Record by setting the recording format of the recording software to ISO9660 level 1 or level 2 (not including extension format).

Select CD-ROM (mode 1) for the disc format. Discs recorded with CD-ROM xA (mode 2) cannot be played on this deck.

### *When playing back CD-R/RW*

Insert a CD-R/RW disc having recorded MP3 files. The system will automatically determine whether the disc is a music CD or a CD-R/RW with MP3 files and begin playing the disc. A music CD recorded onto a CD-R/RW can also be played. However, depending on the type of disc being used, a disc may not play.



- A fixed bit rate of 128kbps and sampling frequency of 44.1kHz is recommended for obtaining stable audio quality at playback.
- Depending on the characteristics of a disc, CD-R and CD-RW may not be able to read the disc.
- Because there are many types of MP3 encoding software available, including commercial and freeware programs, audio quality may deteriorate, noise may be generated when playing starts and some recordings may not play, depending on the condition of the encoder and the file format.
- When files other than MP3 files are recorded on a disc, the system may take some time to recognize the disc and it may not play the disc.

# How to use the CD changer

An optional CD changer can be connected and used.

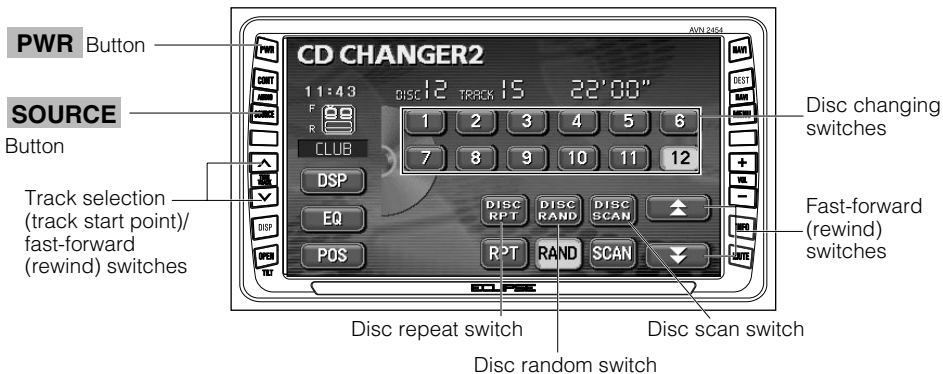

## Listening to CD

Playing a CD

- 1 Press **SOURCE**.
- 2 When only one CD changer is connected, touch **CDCH1**. When two CD changers are connected, touch **CDCH1** or **CDCH2**.

## Selecting a CD

Refer to "How to use the CD player" (page 38).

## Fast-forwarding/rewinding

Refer to "How to use the CD player" (page 39).

## Selecting a CD

A CD can be selected from among all the discs on a changer.

**1** Touch one of the disc changing switches.

- The number for the selected CD will change color.

## Searching for a song or CD from all CDs in changer

### *Searching for a song*

Refer to "How to use the CD player" (page 39).

### *Searching for a CD*

**1** Touch **DISC SCAN**.

- The system will play the first 10 seconds of the first song on each CD in the changer. Touching **DISC SCAN** again will continue playing the current song.



- The system will display the amount of disc changing switches that matches the number of CDs that can be inserted into the CD changer, and it will only allow selection of disc numbers that have discs currently loaded.
- No operation is possible when there are no discs loaded into the CD changer.
- When a CD changer is connected, an optional CD changer deck or CD changer can be switched using **CDCH1** and **CDCH2**.

## Repeating a song or CD

### *Repeating the current song*

Refer to "How to use the CD player" (page 39).

### *Repeating the current CD*

**1** Touch **DISC RPT**.

- Touching **DISC RPT** once will cause repeating of the CD until the function is cancelled. Touching **DISC RPT** again will cancel repeating of the CD.

# How to use the CD changer

---

## Playing songs in random order

### *Playing songs on current CD in random order*

Refer to "How to use the CD player" (page 39).

### *Playing songs on all CDs in random order*

**1** Touch **DISC RAND**.

- Touching **DISC RAND** will play songs in random order until the function is cancelled. Touching **DISC RAND** again will cancel random playing of songs.
- The song to be played next is randomly selected at the end of current song, so it is possible that a single song could end up being played twice in a row.

## Turning off the CD player

**1** Press **PWR**.

- Pressing **PWR** again will start playing.

# MEMO



# Before using the DVD player

This unit can play high quality images and high quality digital sound of DVD videos. It is also possible to switch between different languages recorded on the DVD video (dubbing, subtitles, etc.), and with videos having several angles of the same scene recorded, the preferred angle can be selected and played.

## DVD video characteristics

### About Multiple Languages

Some DVD discs have dialog recorded in several different languages, and the language can be switched during playback in the same way as multilingual TV broadcasts.



An airplane was flying in the night sky...

### About Multiple Angles

Some DVD discs have a single scene recorded from several different angles (multiple angle), and the preferred angle can be switched during playback.

- Depending on the disc, multiple angles may not be recorded.

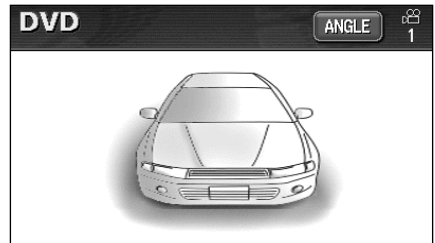

The angle of the image is changed.

## About Subtitles

Some DVD discs have subtitles recorded in several different languages, and the subtitles can be switched during playback. The video can also be played without any subtitles displayed.





Caution

This unit includes copyright protection technology used in accordance with US patents and other intellectual property rights owned by Macrovision Corporation and other entities. Use of this copyright protection technology requires approval from Macrovision Corporation and the technology must not be used for audiovisual purposes aside from general household use without special approval from Macrovision Corporation. Modification and disassembly of this technology is prohibited.

## About discs

### About playable discs

This unit conforms to NTSC color television methods, so please use discs that display "NTSC" on the disc or package. This unit cannot play discs using color television methods other than NTSC (such as PAL, SECAM).

Playable Disc Types and Their Marks	Size/Playing Surface	Maximum Playing Time
	12 cm/single-sided 1 layer 2 layer	<Using MPEG 2> 133 min. 242 min.
	12 cm/double-sided 1 layer 2 layer	266 min. 484 min.



# Before using the DVD player

## About region codes of playable discs

Some DVD discs display a  ("Region Code"). The mark (a number) shows the geographical region where the disc can be played. This unit cannot play discs that do not show "1" or "ALL" on the mark, discs that do not display the region mark may in fact be controlled by region and may not be playable on this unit.







Caution

The playing condition is determined by the intention of the DVD/software creator. Some functions may not perform during operation because this unit is playing the disc according to content specifications intended by the software creator. Be sure to consult the explanatory material provided with the disc to be played.

## About marks displayed on discs

The following marks may be displayed on a DVD disc or its package.

Mark	Meaning
	Shows number of voice tracks.
	Shows number of subtitle languages.
	Shows number of filmed angles.
<div style="display: flex; justify-content: space-around; align-items: center;"> <div style="border: 1px solid black; padding: 2px; text-align: center;">16:9</div> <div style="border: 1px solid black; padding: 2px; text-align: center;">LB</div> <div style="border: 1px solid black; padding: 2px; text-align: center;">4:3</div> </div>	Shows available aspect ratio (television screen horizontal to vertical ratio). • "16:9" is wide screen, "4:3" is standard screen.
<div style="display: flex; justify-content: space-around; align-items: center;"> <div style="border: 1px solid black; border-radius: 50%; padding: 5px; text-align: center;"></div> <div style="border: 1px solid black; border-radius: 50%; padding: 5px; text-align: center;"></div> </div>	Shows playable region code. • ALL indicates worldwide. A number indicates a specific region code. "1" is the region number for North America.

## About DVD disc structure

Videos and songs recorded on a DVD are divided into many segments.

Large segments are called "titles", and each title has a number ("title number").

Title segments are further divided into smaller segments called "chapters", and each chapter has a number ("chapter number").

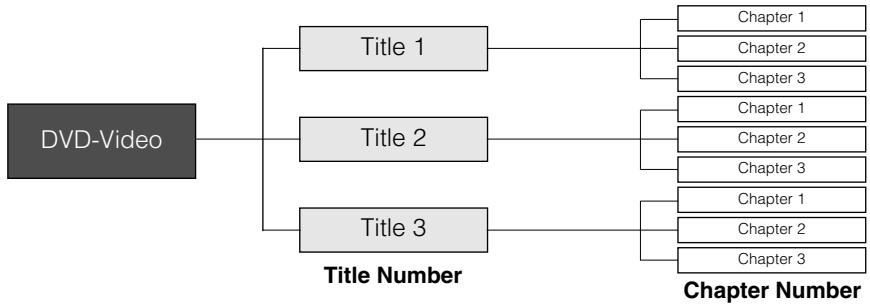

# Before using the DVD player

## About flow of operations

The section below describes the flow for items such as operation and search of images and default settings for the DVD player.

- Pressing **CONT** or touching the screen switches to the operation screens shown below.

•DVD operation screen



•Title screen



•Menu operation screen



•Menu number search screen



•Default settings screen



# How to use the DVD player

A DVD can be watched only if the vehicle is completely stopped in a safe location with the parking brake set and the ignition switch turned to ON or ACC. (Only sound can be heard if a DVD is played while the car is in motion.)

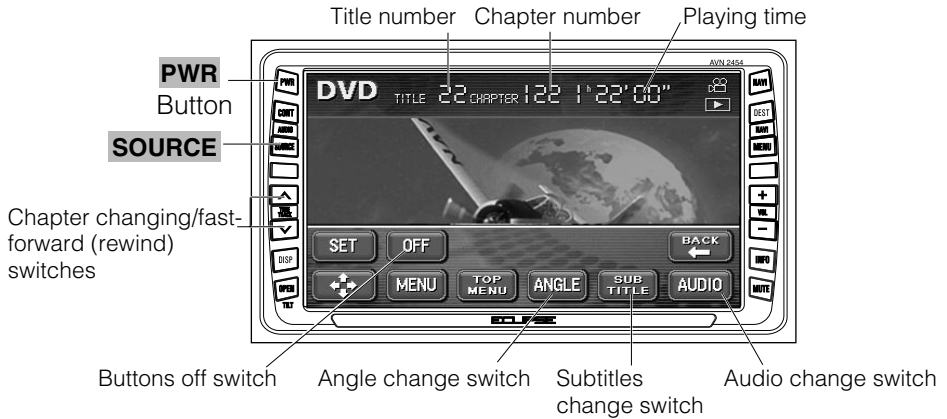

## Watching a DVD

Start playback by inserting a DVD into the DVD insertion slot, which will automatically turn on power.

**1** Press **SOURCE** while a DVD is inserted.

**2** Touch **DVD**.

- Playback will begin.
- If the operation switches (touch switches) are being displayed, press **CONT** or touch the screen.

# How to use the DVD player

## Operating the video

### Playing the video

1 Touch .





### Fast Forward/Rewind

It is possible to fast-forward or rewind through the video being played.

Using panel button

1 Press  or  until a beep is heard.

-  (up): Advances the video
-  (down): Rewinds the video
- The deck switches to the fast-forward (rewind) mode when the beep is heard and will

Fast-forwarding/rewinding using the touch switches

1 Touch  or .

- The deck switches to the fast-forward (rewind) mode when the beep is heard and will continue fast-forwarding (rewinding) until your finger is removed from the switch.



- Information for items such as touch switches will be displayed for about 6 seconds. Pressing **CONT** or touching the screen will display them again.
- Depending on the disc, automatic playback may not function or playback may not function unless a menu recorded on the disc is selected. (Refer to "Operating the disc menu" on page 62.)

## Pausing the video

1 Touch **⏸**.

- While paused ( **⏸** ), briefly touching **⏩** will play in slow motion and touching **⏸** will play frame-by-frame.



## Stopping the video

1 Touch **■**.



# How to use the DVD player

## Turning off the DVD

- 1 Press **PWR**.
  - Pressing **PWR** again will start playing (audio only).

## Operating the disc menu

It is possible to use the menu recorded on the disc.

- 1 Touch **NEXT** on the DVD operation screen.
- 2 Touch **MENU** or **TOP MENU**.
- 3 Touch **⬆**.



- 4 Touch **⬆**, **⬇**, **⬅**, **➡** and select the video to play.
- 5 Touch **ENTER**.



## Searching for a desired chapter

It is possible to search for a particular video segment by title and chapter or by menu number (number for divided segments).

### Searching by chapter

- 1 Press **⬆** or **⬇**.
  - **⬆** (up): Selects next chapter
  - **⬇** (down): Selects previous chapter

chapter number





Recorded menu items will differ by disc. Some functions may not perform during operation because playback is following disc content specifications.

## Searching by title number

1 Touch **NEXT** on the DVD operation screen.

- The title number input screen will be displayed.



2 Input the title number by touching **-**, **+**, **-10**, **+10**.

- Touching **-** or **+** changes the title number by ones.
- Touching **-10** or **+10** changes the title number by tens.

3 Touch **ENTER**





# How to use the DVD player

## Searching by menu number .

1 Touch **NEXT** on the DVD operation screen.

2 Touch **+** on the DVD operation screen.



3 Touch **NUMBER**.

•The menu number input screen will be displayed.



4 Input the title number by touching **-**, **+**, **-10**, **+10**.

- Touching **-** or **+** changes the title number by ones.
- Touching **-10** or **+10** changes the title number by tens.



5 Touch **ENTER**.

## Changing the touch switch display

Display of the touch switches can be changed or turned off.

### Turning off the touch switches

1 Touch **NEXT** on the DVD operation screen.

•Pressing **CONT** or the touching the screen will display the touch switches again.



## Changing the touch switch display locations

- 1 Touch **NEXT** on the DVD operation screen.
- 2 Touch **+** on the DVD operation screen.
- 3 Touch **POSITION**.

- The position of the touch switch will move up or down with each touch of the screen.



## Switching between screen display and audio

It is possible to change the language for subtitles, the language for audio and the display angle for the video being played.

### Switching the video angle

When several angles of a scene are recorded on a disc, the angle can be switched.

- 1 Touch **NEXT** on the DVD operation screen.
- 2 Touch **ANGLE** when the multi-angle mark is displayed.
  - The angle number will be displayed.



- 3 Touch **ANGLE**.
  - The angle number will change and the angle of the video will be switched.



# How to use the DVD player

## Switching subtitle languages

When subtitles in several languages are recorded on a disc, the subtitles can be switched.

1 Touch **NEXT** on the DVD operation screen.

2 Touch **SUB TITLE**.

- The subtitle number and language will be displayed.



Subtitle number and language

3 Touch **SUB TITLE**.

- Switches the subtitle number each time the touch switch is touched and switches the displayed subtitle language.



- Each time **ANGLE** is pressed, the angle will change in order from among the angles recorded on the disc.
- Each time **SUB TITLE** is pressed, the subtitle language will change in order from among the subtitles recorded on the disc.

## Switching dubbed audio language

When dubbed voices in several languages are recorded on a disc, the voices can be switched.

1 Touch **NEXT** on the DVD operation screen.

2 Touch **AUDIO**.

- The audio number and language will be displayed.



Audio number and language

3 Touch **AUDIO**.

- The audio number will change and the language of voices being played will be switched.



- Each time **AUDIO** is pressed, the audio language will change in order from among the languages recorded on the disc.  
Language 1 → Language 2 → Language...
- The dts format is not supported by this deck, so no audio will be emitted when "dts audio" is selected by a disc having dts audio recorded on it. In this case, select "Dolby Digital audio" from that is definitely recorded on the DVD video.
- dts is a registered trademark of the US company Digital Theater Systems, Inc.

# How to use the DVD player

## Setting the DVD player

The language preference for voices, subtitles and menu display used during DVD playback can be set in advance. Optional display of the multiple angle mark, viewer restriction and other functions can also be set.

1 Touch **NEXT** on the DVD operation screen.

2 Touch **SET**.

3 Touch **SETUP**.

•The SET UP screen will be displayed.

4 Touch any of the touch switches. Settings can be made for the following items.

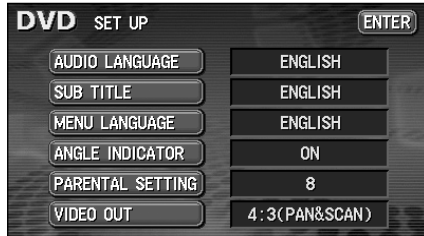

Touch switch	Function	Page
<b>AUDIO LANGUAGE</b>	Sets the language of voices for video playback.	69
<b>SUB TITLE</b>	Sets the language of subtitles for video playback.	69
<b>MENU LANGUAGE</b>	Sets the language of displayed menus.	70
<b>ANGLE INDICATOR</b>	Sets display/non-display of multiple angle mark.	71
<b>PARENTAL SETTING</b>	Restricts the types of DVD videos that can be played.	72
<b>VIDEO OUT</b>	Sets screen size.	73



Pressing one of the switches that can switch screens ( **CONT** or **SOURCE** ) without touching **ENTER** after changing settings with the default setting screen will stop playing of the DVD. Touch **▶** on the operation screen to start playback again. (Refer to page 59.)

## Setting the audio language

The preferred language for the video being played can be selected.

1 Touch **AUDIO LANGUAGE** on the SET UP screen.

2 Touch the preferred language.

- Touching **OTHER** enables setting of a language other than those displayed on the screen.



Input a code

1 Touch **OTHER** on the AUDIO LANGUAGE setting screen.

2 Input a language code.

- Refer to "Language code table" (page 74) for language codes.

3 Touch **ENTER**.



## Subtitle language setting

The preferred subtitles for the video being played can be selected.

1 Touch **SUB TITLE** on the SET UP screen.

2 Touch the preferred language.

- Touching **OTHER** enables setting of a language other than those displayed on the screen.
- Touching **OFF** plays the video with no subtitles on the screen.



# How to use the DVD player

Input a code

- 1 Touch **OTHER** on the SUB TITLE setting screen.
- 2 Input a language code.
  - Refer to "Language code table" (page 74) for language codes.
- 3 Touch **ENTER**.



Language switching cannot be performed if the selected language is not recorded on the disc.

## Menu language setting

Allows selection of a preferred menu language from those recorded on the disc. The setting can be made by either selecting the language from a list or by entering a language code.

- 1 Touch **MENU LANGUAGE** on the SET UP screen.
- 2 Touch the preferred language.
  - Touching **OTHER** enables setting of a language other than those displayed on the screen.



Input a code

- 1 Touch **OTHER** on the MENU LANGUAGE setting screen.
- 2 Input a language code.
  - Refer to "Language code table" (page 74) for language codes.
- 3 Touch **ENTER**.



## Setting display of multi-angle mark (angle selection mark)

The multi-angle mark can be set to display/not display for the video being played.



1 Touch **ANGLE INDICATOR** on the SET UP screen.

- Each time **ANGLE INDICATOR** is pressed, the condition will switch between "ON" and "OFF".

2 Touch **ENTER**.

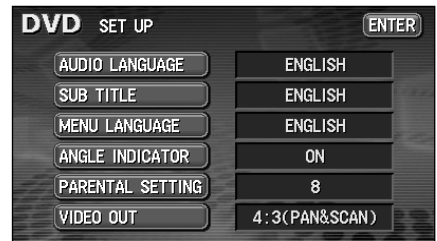

- Switching to another language will not be possible if the language selected is not available on the disc.
- Setting multi-angle mark display to "ON" will display the multi-angle mark in the upper right corner of the screen when multiple angles are available on the disc.



# How to use the DVD player

## Viewer restriction setting

This function allows restriction of viewing so that discs with adult themes or violent scenes will not be available to children. Viewer restriction can be set at different levels to match restriction ratings.

- 1 Touch **PARENTAL SETTING** on the default setting screen.
- 2 Enter a password by touching one number at a time.
- 3 Touch **ENTER**.
- 4 Touch the preferred restriction level.
- 5 Touch **ENTER**.

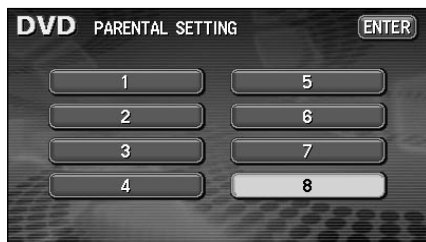
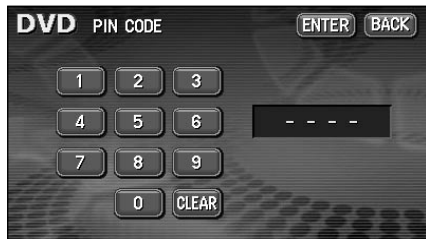

- Restriction cannot be set for discs not having a viewer restriction level recorded.
- Be sure to enter a password number. If a number is not entered, setting of viewer restriction will not be possible.
- The password to be shown in the upper section will be displayed as **----** when a password has not yet been set.
- Once the password has been set, the password will be required for subsequent use of this function. Please do not forget the password. If the password is forgotten, the default condition (no password set) can be restored by touching **CLEAR** 10 times.
- Viewer restriction levels are classified in 3 types.
  - Level 1.....Plays only DVD software intended for children. (Playing of DVD software intended for general audiences or adult audiences is prohibited.)
  - Level 2~7....Plays only DVD software intended for children or general audiences. (Playing of DVD software intended for adult audiences is prohibited.)
  - Level 8.....Plays all DVD software. (Factory setting)

## Changing video output

**1** Touch **VIDEO OUT** on the default setting screen.

- Each time **VIDEO OUT** is pressed, the screen size will be changed in the order shown below.

16 : 9 → 4 : 3 → 4 : 3

letter box → pan & scan

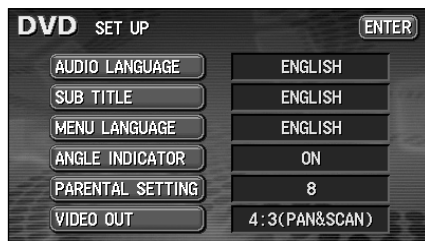

**2** Touch **ENTER**.

### •16:9

The video is displayed in normal wide size. DVD software recorded in 4:3 size will be displayed with black left and right edges or will be expanded to the left and right.

### •4:3 (letter box)

The video is displayed with black upper and lower edges. DVD software recorded in 4:3 size will be displayed exactly at screen size (4:3).

### •4:3 (pan & scan)

The video is displayed with right and left edges cut off. DVD software recorded in 4:3 size will be displayed exactly at screen size (4:3).



ATTENTION

When another monitor such as the rear seat monitor is being used, the size of the video being displayed in the rear seat monitor will differ according to the video output size that is set by the deck (front).



Caution

There are no problems with using this function as long as the customer views images privately in wide-screen format. However, if the images are compressed or enlarged for viewing for any commercial or public purpose, it may infringe the rights of the copyright holder under applicable copyright laws.

# How to use the DVD player

## Table of language codes

These codes are used to specify the language for audio tracks, subtitles and on-screen menu displays.

Language	Input code	Language	Input code	Language	Input code
Japanese	1001	Hindi	0809	Kirundi	1814
English	0514	Croatian	0818	Romanian	1815
French	0618	Hungarian	0821	Kinyarwanda	1823
German	0405	Armenian	0825	Sanskrit	1901
Italian	0920	Interlingua	0901	Sindhi	1904
Spanish	0519	Interlingue	0905	Sangho	1907
Dutch	1412	Inupiak	0911	Serbo-Croatian	1908
Russian	1821	Indonesian	0914	Sinhalese	1909
Chinese	2608	Icelandic	0919	Slovak	1911
Korean	1115	Hebrew	0923	Slovenian	1912
Greek	0512	Yiddish	1009	Samoan	1913
Afar	0101	Javanese	1023	Shona	1914
Abkhazian	0102	Georgian	1101	Somali	1915
Afrikaans	0106	Kazakh	1111	Albanian	1917
Amharic	0113	Greenlandic	1112	Serbian	1918
Arabic	0118	Cambodian	1113	Siswati	1919
Assamese	0119	Kannada	1114	Sesotho	1920
Aymara	0125	Kashmiri	1119	Sundanese	1921
Azerbaijani	0126	Kurdish	1121	Swedish	1922
Bashkir	0201	Kirghiz	1125	Swahili	1923
Byelorussian	0205	Latin	1201	Tamil	2001
Bulgarian	0207	Lingala	1214	Telugu	2005
Bihari	0208	Laothian	1215	Tajik	2007
Bislama	0209	Lithuanian	1220	Thai	2008
Bengali	0214	Latvian	1222	Tigrinya	2009
Tibetan	0215	Malagasy	1307	Turkmen	2011
Breton	0218	Maori	1309	Tagalog	2012
Catalan	0301	Macedonian	1311	Setswana	2014
Corsican	0315	Malayalam	1312	Tonga	2015
Czech	0319	Mongolian	1314	Turkish	2018
Welsh	0325	Moldavian	1315	Tsonga	2019
Danish	0401	Marathi	1318	Tatar	2020
Bhutani	0426	Malay	1319	Twi	2023
Esperanto	0515	Maltese	1320	Ukrainian	2111
Estonian	0520	Burmese	1325	Urdu	2118
Basque	0521	Nauru	1401	Uzbek	2126
Persian	0601	Nepali	1405	Vietnamese	2209
Finnish	0609	Norwegian	1415	Volapuk	2215
Fiji	0610	Occitan	1503	Wolof	2315
Faroese	0615	Oromo	1513	Xhosa	2408
Frisian	0625	Oriya	1518	Yoruba	2515
Irish	0701	Panjabi	1601	Zulu	2621
Scots- Gaelic	0704	Polish	1612		
Galician	0712	Pashto	1619		
Guarani	0714	Portuguese	1620		
Gujarati	0721	Quechua	1721		
Hausa	0801	Rhaeto-Romance	1813		

# MEMO



# How to use the VTR

Video tapes can be played by connecting a commercially available VTR deck. Videos can be played only when the ignition switch is at ON or ACC and the vehicle is completely stopped and parking brake set for safety considerations. (If the VTR mode is activated while the vehicle is in motion, only the audio will be played.)



## Viewing the VTR

1 Press **SOURCE** .

2 Touch **VTR** .

- The VTR screen will be displayed.
- Press **CONT** or touch the screen to display the VTR operation screen.

## Turning off the VTR mode

1 Press **PWR** .

- Pressing **PWR** again will start playing.
- Pressing **SOURCE** and then **VTR** will play the video being played before power was turned off.



- After switching to the VTR operation screen, touch switches will be displayed for about 6 seconds. Pressing **CONT** will display them again.
- The VTR operation screen will be displayed by touching the screen, even when the VTR is playing.



# How to use the Card remote control

The card remote control is sold separately. Ask for one at the store of purchase.



## Precautions in use of the remote control

- Be careful when handling the control, especially because it is small and light. Dropping or striking it hard may damage it, wear out the battery or cause a malfunction.
- Keep the remote control free of moisture, dust and water. Do not subject it to shock.
- Do not place the remote control unit where it will get hot, such as on the dashboard or near a heater vent. Allowing the remote control unit to overheat may warp its case or cause other problems.
- Do not operate the remote control unit while driving because doing so could cause an accident.
- When using the remote control, point it directly at the remote control light receptor.
- The light receptor may not operate correctly if it is exposed to bright light such as direct sunlight.
- Be sure to press the **PWR** button on the main unit for more than two seconds to shut it down before leaving the car, or the car battery may be run down. When the main unit is shut down, the remote control will not work.
- Remove the batteries from the remote control unit whenever it is not to be used for a long time.

## Cleaning the remote control

- Use a dry cloth to keep the unit clean. If the remote control unit gets extremely dirty, clean it with a cloth moistened in dilute liquid detergent. Do not use alcohol or thinner; these compounds may damage the finish.
- In no event should benzine or thinner be used. These substances will damage the case or finish.

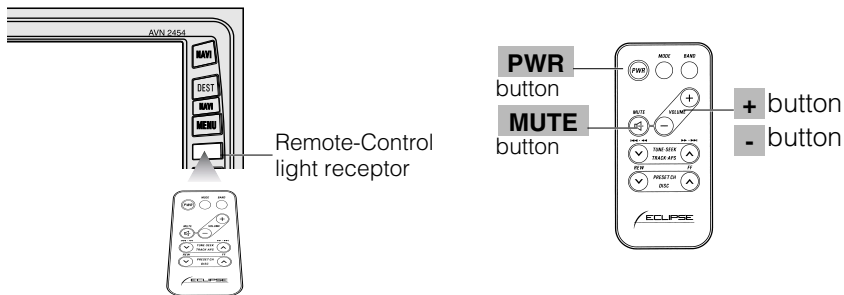

## Turning the power on/off

When the power is turned on, the state used when the power was turned off such as CD and tuner playing is restored.

**1** Press the **PWR** button.

- The power turns on or off each time the button is pressed.



When the main unit is shut down, the remote control will not work.

## Adjusting the audio volume

**1** Press the **+** or **-** button.

- +** button: Increases the volume.
- button: Decreases the volume.

### *Cutting the volume instantly (muting)*

Press the **MUTE** button to cut the volume or restore it instantly.



# How to use the Card remote control

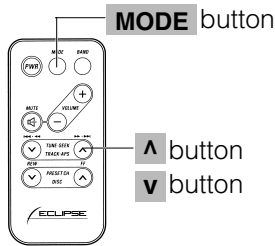

## Switching playback modes

1 Press the **MODE** button.

- Press the button to switch modes in the following sequence:

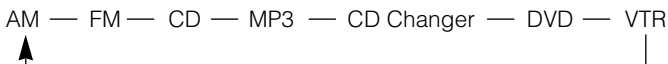

## How to play the tuner

Select the tuner mode first.

### Selecting the FM/AM band

1 Press the **MODE** button.

### Selecting a station (manually or automatically)

A short press of the button will allow manual station tuning.

1 Press the **v TUNE SEEK ^** button.

**^** button:

Tunes to higher frequency stations.

**v** button:

Tunes to lower frequency stations.

## Selecting preset stations

A total of six stations may be selected (preset tuning) out of those already set in memory through the main unit. (Refer to "Manually setting stations into memory," page 35.)

**1** Press the **v PRESET CH ^** button.

**^** button:

Select the next higher number preset button.

**v** button:

Select the next lower number preset button.

# How to use the Card remote control

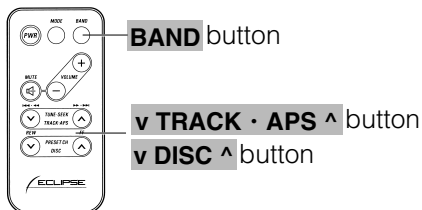

## How to play CDs

- Select the CD mode first.

### Switching disc modes

- 1 Press the **BAND** button

When two CD changers are connected, press the **BAND** button to change modes from the CD changer 1 to the CD changer 2.

The indicator will skip a changer or player that has no discs loaded.

### Advancing to the next track or returning to the beginning of the track being played

- 1 Press the **v TRACK · APS ^** button.

**^** button: Skips to the next track.

**v** button: Returns to the beginning of the track being played. (Press



Hold the **^** button down to fast forward, or the **v** button to rewind through the track being played.

### Skipping to the next or previous disc

- 1 Press the **v DISC ^** button.

**^** button: Selects the next higher number disc.

**v** button: Selects the next lower number disc.

## Replacing the battery



To prevent accidents, store batteries out of the reach of children. If a child has swallowed one, consult a doctor immediately.

Use one CR2025 battery.

- 1 On the back of the remote control, while pressing the locking knob on the battery slot cover toward your right, pull out the battery carrier with your fingernail.

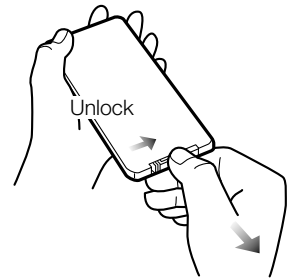

- 2 Remove the old battery, then place the new one in the carrier with the (+) mark facing up.

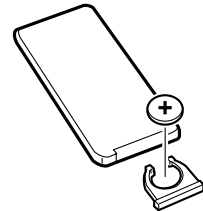

- 3 Push in the carrier until it snaps into place.

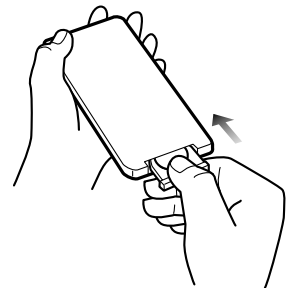

Be extremely careful not to swallow the battery.

# Information you should know

## If one of these messages appears

If any of the following messages are displayed, check the unit while referring to the Cause and Remedy columns.

Messages	Cause	Corrective action
CD SEEK	The CD changer is searching for discs when a magazine has been set in the CD changer.	Wait until the unit has finished identifying the type of disc.
CD DOOR OPEN	The door of the CD changer is open.	Close the door of the CD changer.
CHECK DISC	The CD/MP3/DVD is dirty or is upside down.	Clean the disc if it is dirty. Insert the disc correctly if it is upside-down.
NO DISC NO CD	There is no disc in the CD/MP3/DVD player or CD changer.	Load a music disc.
CD ERROR DVD ERROR DISC ERROR	The CD/MP3/DVD player or CD changer will not move for some reason.	<b>Eject the disc.</b>
CD ERROR DVD ERROR DISC ERROR	The temperature of the CD/MP3/DVD player or CD changer has become unusually high.	Without performing any other operations, wait until the temperature comes down.
NO CD MAGAZINE	There is no magazine in the CD changer.	Load a magazine.
CD OO CHECK	The OO spot in the CD changer has a CD that cannot be read.	Check for a properly loaded music CD.
PASS CODE INCORRECT	The language code selected does not match the DVD.	Check that the language code matches the DVD.
PARENTAL LOCK ENABLED	Viewing restrictions are enabled.	Change the setting for viewing restrictions and start again. (Refer to page 72.)
CURRENTLY THIS FUNCTION IS DISABLED	A function that has been disabled was selected with the menu.	Follow the directions on the screen and start again.
CURRENTLY THIS FUNCTION IS DISABLED	A function that cannot be used while the vehicle is in motion was selected.	Stop the vehicle.
INVALID CODE	A number not supported was input for selecting a language code.	Input a valid language code.
REGION CODE ERROR	The region code (controlled region for playback) of the disc isn't acceptable.	Check that the DVD has a region code that can be played on this deck. (Refer to page 14.)
NO CHAPTER OR TITLE AVAILABLE	The selected chapter/title does not exist.	Select a chapter/title that is on the disc.

- 1: If the DVD player still will not work after the disc is ejected, contact the place of purchase.
- 2: If this happens, wait for a while. When the temperature inside the unit returns to normal, the message will disappear and playback will start. If the message does not disappear after a long period of waiting, contact the place of purchase.

## Before asking for repairs

Slight differences in operation can sometimes be mistaken for malfunctions, so check the following table before asking for any repairs.

If the following fail to solve the problem, contact the place of purchase.

Problem	Possible reason	Corrective action
The screen is dark for a brief period when the power is turned on at low temperatures.	This is a characteristic of LCDs.	This is not a malfunction. Wait for a brief period.
The display is distorted for a brief period after the power is turned on.	This is a characteristic of LCD backlighting.	This is not a malfunction. The display will stabilize after a brief period.
No sound comes out.	Volume is poorly adjusted.	Press the volume switch and check volume.
Sound comes out of only one side (left or right, front or back).	A speaker cord is disconnected.	Check the connections of the speaker cords.
	Volume is poorly adjusted.	Check the left/right volume adjustments.
Sound quality does not change even after making adjustments.	The adjusted audio quality is not included in the radio broadcast or disc.	Check by changing the radio station or disc.
A CD/DVD will not go into the deck.	Power is not turned on.	Turn the vehicle ignition switch to [ACC] or [ON].
	A disc is already inserted and you are trying to insert a second disc.	Eject the previously inserted CD/DVD and insert the preferred CD/DVD.
A CD/DVD cannot be played.	There is water condensation in the deck.	Do not use the deck for a while and then try using it again. (Refer to pages 14-16.)
	There is a large scratch or warp in the CD/DVD.	Insert a different CD/DVD.
	The CD/DVD is very dirty.	Clean the CD/DVD. (Refer to page 15.)
	The CD/DVD is upside down.	Insert the CD/DVD with the proper orientation. (Refer to page 15.)
	A non-supported type of CD/DVD has been inserted.	Insert a CD/DVD that is supported by the deck. (Refer to pages 14-16.)
<b>CDCh1</b> / <b>CDCh2</b> is not displayed on the screen.	The CD changer is not completely connected.	Check the connections to the CD changer.
Audio is output, but not video.	The screen has been turned off with the screen OFF button.	Press <b>CONT</b> or <b>NAVI</b> . (Refer to page 31.)
Audio is output, but not DVD video. (With vehicle stopped.)	The parking brake has not be set.	Set the parking brake.
Neither video nor audio is output.	The vehicle ignition switch has not been turned on.	Turn the vehicle ignition switch to [ACC] or [ON].
	The connection cord is not completely connected.	Check the connections to each connection cord.
There is a point of light on the display.	At least 99.99% of the pixels on the LCD panel are effective, but it is possible that 0.01% of the pixels may not light or may stay lighted.	This is not a defect, so please use the deck in this condition.

## ***Information you should know***

---

### **Products equipped with Dolby Digital**

Manufactured under license from Dolby Laboratories, Inc.

"Dolby" and the double-D symbol are trademarks of Dolby Laboratories.

Confidential unpublished work. (c) 1992-1997 Dolby Laboratories, Inc. All rights reserved.



### **Products equipped with Macrovision**

This unit includes copyright protection technology used in accordance with US patents and other intellectual property rights owned by Macrovision Corporation and other entities. Use of this copyright protection technology requires approval from Macrovision Corporation and the technology must not be used for audiovisual purposes aside from general household use without special approval from Macrovision Corporation. Modification and disassembly of this technology is prohibited.

# Glossary

---

## CD-R (Compact Disc Recordable)

---

This is a disc that can only be recorded once. Recorded data cannot be deleted. There are two types of CD-R, one having capacity of 650MB (74 minutes of music), the same as a regular CD, and the other having capacity of 700MB (80 minutes of music).

## CD-DA (Compact Disc Digital Audio)

---

This disc is the standard for recording and playing of music data. One track is recorded with one song, and a maximum of 74 minutes can be used with the CD.

## CD-RW (Compact Disc Rewritable)

---

This disc uses a phase transformation method that enables recording and deleting of data as many times needed. Capacity is 700MB (80 minutes of music).

## EQ (Equalizer)

---

This enables setting of stronger or softer playing of sounds throughout the high to low range of the sound. Levels can be adjusted to personal preference, enhancing enjoyment of the music.

## MP3 (MPEG-1 Audio Layer 3)

---

This is one technology (digital compression technology) used during compression of audio data for sounds such as music. Because it has high data compression efficiency, it is generally used to enable obtaining of audio files from music distribution sites on the Internet.

## LPCM (Linear PCM)

---

This is an abbreviation for Linear Pulse Code Modulation, a signal recording method used with music CDs. A music CD is recorded at 44.1kHz/16 bit, but a DVD is recorded at 48kHz/16 bit ~ 96kHz/24 bit, enabling a DVD to be played with higher sound quality than a music CD.

## MPEG

---

This is an abbreviation for Moving Picture Experts Group and is pronounced "empeg". It is the international standard for moving image compression. With DVDs, this method is also used to compress and record digital audio.

## Copy Control CD

---

This is a CD that has controls for preventing computers from copying and ripping (taking audio information recorded on a compact disc and using it as data to create a file).



# Glossary

---

## UDF (Universal Disc Format)

---

This is one format for use with optical discs not reliant on the OS. It is used with media such as DVD and CD-RW.

## Track

---

The single division for a song on a music CD is called a track.

## Viewing Restriction

---

This is a DVD video function that "Restricts playing of discs that support viewing restrictions, in accordance with the regulated levels of each country." Restrictions differ by DVD video and may completely prevent playing of the video or may skip or insert alternate scenes for extreme scenes.

## Title

---

This is the largest unit for divisions of video or songs recorded on a DVD video. Usually a single movie is treated as a title by video software and a single album (or song) is treated as a single title by music software. The consecutive numbers attached to titles are called title numbers.

## Chapter

---

This is a unit for divisions of video or songs recorded on a DVD video, but it is a smaller unit than a title. A single title is made up of several chapters, and the consecutive numbers attached to chapters are called chapter numbers.

## Multi-Angle

---

This is one feature of DVD video, where viewpoints of the same scene are changed by recording from several different angles (camera positions), allowing the viewer to select the preferred angle.

## Multi-Language

---

This is one feature of DVD video, where the same scene is recorded with several different languages and subtitles, allowing the viewer to select the preferred language.

## Region Code

---

DVD players and DVD discs have a region code that enables playing by geographic marketing regions, and a disc cannot be played if the number recorded on the disc is not included in the region codes of the player. Refer to page 55 for details on region codes.

# Index by topic

## About screen and sound adjustment

[Regarding screen adjustment]

<b>To make the audio operation screen or VTR screen easier to see</b>	
"Adjusting/setting the screen"	P30
<b>To turn off the screen</b>	
"Turning off the screen"	P31
<b>To change the wallpaper</b>	
"Changing the wallpaper"	P29
<b>To set the screen to wide mode</b>	
"Switching screen mode"	P32

[Regarding audio adjustment]

<b>To change the volume</b>	
"Adjusting the volume"	P20
<b>To turn on/off the guide tone used at switch operation</b>	
"Setting the BEEP tone"	P27
<b>To adjust sound quality</b>	
•To change the acoustic environment of a performance	
"Setting DSP (acoustics) mode"	P22
•To adjust high and low sounds	
"Adjusting EQ (equalizer)"	P23

## Audio

## About using the radio

<b>To play the radio</b>	
"Playing the radio"	P34
<b>To search for a radio station</b>	
"Selecting radio stations"	P34
<b>To save radio stations</b>	
"Saving radio stations"	P35

# Index by topic

## About using the CD player/CD changer

### To play a CD

"Playing a CD" P38

### To select a song or CD

"Selecting a song" P38

"Selecting a CD" P50

### When you don't know a song number or on what CD a song is located

"Searching for a song" P39

"Searching for a song or CD from all CDs in changer" P51

### To repeat the song or CD currently being played

"Repeating a song" P39

"Repeating a song or CD" P51

### To play songs in a different order

"Playing songs in random order" P39

### To fast-forward or rewind

"Fast-forwarding/rewinding" P39

## About using the MP3 player

### To play an MP3 file

"Playing MP3" P40

### To select a music file

"Selecting a music file" P41

### When you want to return to a level or don't know the current level

"Changing display of the current level" P42

### To search for a music file

"Searching for a music file" P42

### To repeat a music file

"Repeating the same music file" P43

**To play files in a different order**

"Playing songs in random order"	P43
---------------------------------	-----

**To change the file information**

"About display of file information"	P44
-------------------------------------	-----

**To learn about MP3**

"About MP3"	P45
-------------	-----

**To learn about making MP3 files**

"Making and playing MP3 files"	P48
--------------------------------	-----

**DVD / VTR****About using the DVD player****To play a DVD video**

"Watching a DVD"	P59
------------------	-----

**To learn about discs**

To learn about the marks displayed on discs and packages	
--	--

"About marks displayed on discs"	P56
----------------------------------	-----

To learn about discs that can be played	
---	--

"About playable discs"	P55
------------------------	-----

To learn about disc structures	
--------------------------------	--

"About DVD disc structure"	P57
----------------------------	-----

**To operate the menu recorded on a disc**

"Operating the disc menu"	P62
---------------------------	-----

**To operate the video being played**

"Operating the video"	P60
-----------------------	-----

**To select/search for a video**

"Searching by chapter"	P62
------------------------	-----

"Searching by title number"	P63
-----------------------------	-----

"Searching by menu number"	P64
----------------------------	-----

**To change the display of touch switches**

"Changing the touch switch display"	P64
-------------------------------------	-----

# Index by topic

## To change subtitles, audio or the video angle

"Switching the video angle"	P65
"Switching subtitle languages"	P66
"Switching dubbed voice languages"	P67

## To set the player

"Setting the audio language"	P69
"Subtitle language setting"	P69
"Menu language setting"	P70
"Setting display of multi-angle mark (angle selection mark)"	P71
"Viewer restriction setting"	P72
"Changing video output"	P73

## About using the VTR

### To use the VTR

"How to use the VTR"	P76
----------------------	-----

## Other

## When something isn't clear

### When you don't understand a screen message

"If one of these messages appears"	P84
------------------------------------	-----

### When you think the deck may have a problem

"Before assuming the deck has failed"	P85
---------------------------------------	-----

# Index

## A

Adjusting high and low sounds	P23
Adjusting main volume	P20
Adjusting sound quality	P21
Adjusting the volume	P20
Adjusting volume balance	P26
Angle mark	P71
AUTO.P	P36

## B

Background screen (wallpaper)	P29
Brightness (screen adjustment)	P32

## C

CD-R (CD-Recordable)	P14
CD-RW (CD-Rewritable)	P14
Changing the subtitle language	P66
Color (screen adjustment)	P32
CONT	P18
Contrast (screen adjustment)	P32

## D

Day screen	P31
DISC RAND	P52
DISC RPT	P51
DISC SCAN	P51
DSP	P22

## H

How to use the CD changer	P50
How to use the CD player	P38
How to use the MP3 player	P40
How to use the radio	P34
How to use the VTR	P76

## L

LOUDNESS	P27
----------	-----

## M

Multi-angle mark	P71
------------------	-----

## N

Night screen	P30
Normal mode (screen modes)	P33

## P

POS	P25
-----	-----

## R

RAND	P39,52
RPT	P39,51

## S

Saving radio stations	P35
SCAN	P39,51
Setting the BEEP tone	P27

## T

Tint (screen adjustment)	P32
Turning off the screen	P31

# Index

---

## V

VOLUME switch P20

## W

Wide 1 mode (screen modes) P33

Wide 2 mode (screen modes) P33

Wide 3 mode (screen modes) P33

Woofer P28

---

# MEMO



*MEMO*



This device complies with part 15 of the FCC Rules. Operation is subject to the condition that this device does not cause harmful interference.

## CUSTOMER NOTICE

Please retain this booklet and write in the serial number of your AVN2454 for identification. The serial number is labeled or stamped on the chassis.

Serial No. \_\_\_\_\_



DIVISION OF FUJITSU TEN CORP. OF AMERICA  
19600 SOUTH VERMONT AVENUE, TORRANCE, CA 90502  
(310) 327-2151



090002-26650700  
0402MT (N)

## Free Manuals Download Website

<http://myh66.com>

<http://usermanuals.us>

<http://www.somanuals.com>

<http://www.4manuals.cc>

<http://www.manual-lib.com>

<http://www.404manual.com>

<http://www.luxmanual.com>

<http://aubethermostatmanual.com>

Golf course search by state

<http://golfingnear.com>

Email search by domain

<http://emailbydomain.com>

Auto manuals search

<http://auto.somanuals.com>

TV manuals search

<http://tv.somanuals.com>