

■ Contents

English

1. PRECAUTIONS.....	2
2. CONTROLS.....	3
3. BUTTON TERMINOLOGY.....	4
4. FEATURES.....	5
5. HANDLING COMPACT DISCS.....	6
6. DCP (Detachable Control Panel).....	7
7. REMOTE CONTROL.....	8
8. OPERATION.....	10
9. TROUBLESHOOTING.....	15
10.ERROR DISPLAYS.....	16
11.SPECIFICATIONS.....	17

■ Table des matières

Français

1. PRÉCAUTIONS.....	19
2. COMMANDES.....	3
3. NOMENCLATURE DES TOUCHES.....	20
4. CARACTÉRISTIQUES.....	21
5. MANIPULATION DES DISQUES COMPACTS.....	22
6. CLAVIER DE COMMANDE AMOVIBLE (DCP).....	23
7. TÉLÉCOMMANDE.....	24
8. FONCTIONNEMENT.....	26
9. DÉPISTAGE DES PANNES.....	31
10.AFFICHAGE DES ERREURS.....	32
11.SPÉCIFICATIONS.....	33

■ Índice

Español

1. PRECAUCIONES.....	35
2. CONTROLES.....	3
3. NOMENCLATURA DE LOS BOTONES.....	36
4. CARACTERÍSTICAS.....	37
5. MANEJO DE LOS DISCOS COMPACTOS.....	38
6. PANEL DE CONTROL DESMONTABLE (DCP).....	39
7. CONTROLADOR REMOTO.....	40
8. OPERACIÓN.....	42
9. SOLUCIÓN DE PROBLEMAS.....	47
10.INDICACIONES DE ERROR.....	48
11.ESPECIFICACIONES.....	59

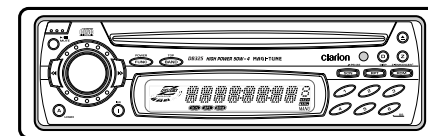

DB325

AM/FM CD PLAYER
•
RADIO AM/FM-LECTEUR CD
•
RADIO AM/FM Y REPRODUCTOR CD

1. PRECAUTIONS

- When the inside of the car is very cold and the player is used soon after switching on the heater, moisture may form on the disc or the optical parts of the player and proper playback may not be possible. If moisture forms on the disc, wipe it off with a soft cloth. If moisture forms on the optical parts of the player, do not use the player for about one hour and the condensation will disappear naturally to allow normal operation.
- Driving on extremely bumpy roads which cause severe vibration may cause the sound to skip.
- This unit uses a precision mechanism. Even in the event that trouble arises, never open the case, disassemble the unit, or lubricate the rotating parts.

This equipment has been tested and found to comply with the limits for a Class B digital device, pursuant to Part 15 of the FCC Rules. These limits are designed to provide reasonable protection against harmful interference in a residential installation. This equipment generates, uses, and can radiate radio frequency energy and, if not installed and used in accordance with the instructions, may cause harmful interference to radio communications. However, there is no guarantee that interference will not occur in a particular installation. If this equipment does cause harmful interference to radio or television reception, which can be determined by turning the equipment off and on, the user is encouraged to consult the dealer or an experienced radio/TV technician for help.

⚠ CAUTION

USE OF CONTROLS, ADJUSTMENTS, OR PERFORMANCE OF PROCEDURES OTHER THAN THOSE SPECIFIED HEREIN, MAY RESULT IN HAZARDOUS RADIATION EXPOSURE. THE COMPACT DISC PLAYER SHOULD NOT BE ADJUSTED OR REPAIRED BY ANYONE EXCEPT PROPERLY QUALIFIED SERVICE PERSONNEL.

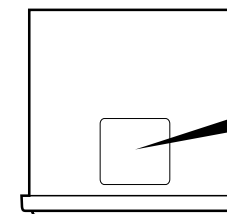

Bottom View of Source Unit

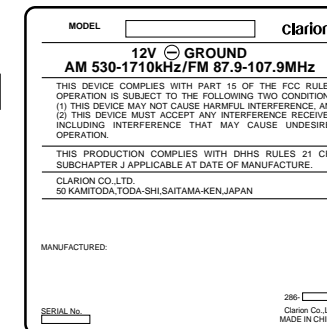

INFORMATION FOR USERS:

CHANGES OR MODIFICATIONS TO THIS PRODUCT WILL VOID THE WARRANTY AND WILL VIOLATE FCC APPROVAL.

Be sure to unfold and read the next page.
Veuillez déployer et vous référer à la page suivante.
Cerciórese de desplegar y de leer la página siguiente.

Clarion Co., Ltd.

All Rights Reserved. Copyright © 2002: Clarion Co., Ltd.
Printed in China / Imprimé en Chine / Impreso en China

PE-2498B
280-7790-00

2. CONTROLS / COMMANDES / CONTROLES

Note: Be sure to unfold this page and refer to the front diagrams as you read each chapter.

Remarque: Veuillez déployer cette page et vous référer aux schémas quand vous lisez chaque chapitre.

Nota: Cuando lea los capítulos, despliegue esta página y consulte los diagramas.

SOURCE UNIT / APPAREIL PILOTE / UNIDAD FUENTE

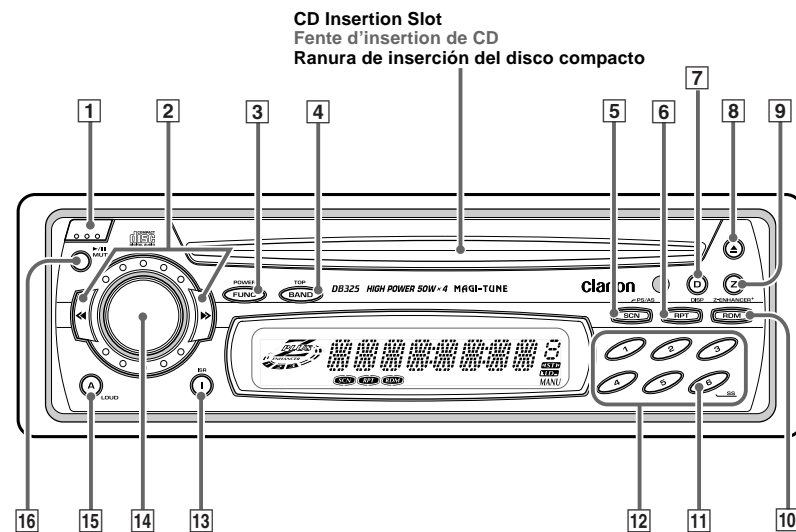

DISPLAY ITEMS/RUBRIQUES D'AFFICHAGE/ ÍTEMES DE VISUALIZACIÓN

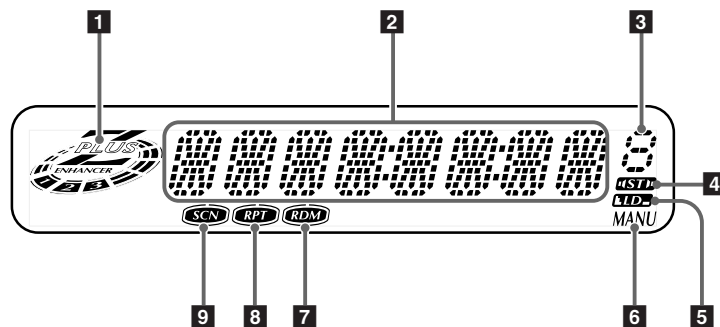

3. BUTTON TERMINOLOGY

Note:

• Be sure to read this chapter referring to the front diagrams of chapter 2. CONTROLS on page 3 (unfold).

Names of Buttons

- | | |
|--|---|
| 1 DCP Release Button | 8 Eject (▲) Button |
| 2 SRCH (Search) Left and Right (◀ and ▶) Buttons | 9 Z (Z-enhancer plus) Button |
| 3 POWER Button
FUNC (Function) Button | 10 RDM (Random) Button |
| 4 BAND (Band) Button
TOP (Top Play) Button | 11 SS (Screen Saver) Button |
| 5 SCN (Scan) Button
PS/AS (Preset Scan/Auto Store) Button | 12 Preset Buttons (1 to 6)
Direct Buttons (1 to 6) |
| 6 RPT (Repeat) Button | 13 ISR (Instant Station Recall) Button |
| 7 DISP (Display) Button | 14 Rotary Knob |
| | 15 A (Audio Mode) Button
LD (Loudness) Button |
| | 16 Play/Pause (▶/) Button
MUTE Button |

Display Items

- | | |
|--|----------------------------|
| 1 Z-EHCR PLUS (z-enhancer plus) indication | 5 LD (loudness) indication |
| 2 Operation status indication
* The frequency, play time, clock, T-SCAN, D-SCAN etc. are displayed. | 6 MANU (manual) indication |
| 3 Preset channel indication (1 to 6) | 7 RDM (random) indication |
| 4 ST (stereo) indication | 8 RPT (repeat) indication |
| | 9 SCN (scan) indication |

4. FEATURES

- Rotary Encoder Volume Control with Rubber
- DIN Chassis with Detachable Control Aluminum Face
- CD-R/CD-RW Compatible
- Z-ENHANCER PLUS for Sound Creation with 3 Adjustment Modes (2-Band P.EQ)
- **MAGI-TUNE**® FM Reception System
- AM/FM Bands-1 AM, 3 FM/18 FM/6 AM Touchbutton Memory
- 8-Times Oversampling Digital Filter and Dual 1-Bit D/A Converters
- Zero-Bit Detector™ Mute Circuit
- Repeat/Random Play/Intro Music Scan
- Blue Negative LC Display
- 4-Channel RCA Line Level Output with Fader Control

5. HANDLING COMPACT DISCS

This unit has been designed specifically for playback of compact discs bearing the  mark. No other discs can be played.

To remove the compact disc from its storage case, press down on the center of the case and lift the disc out, holding it carefully by the edges.

Removing the disc

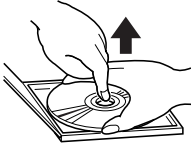

Proper way to hold the compact disc



Always handle the compact disc by the edges. Never touch the surface.

To remove fingermarks and dust, use a soft cloth, and wipe in a straight line from the center of the compact disc to the circumference.

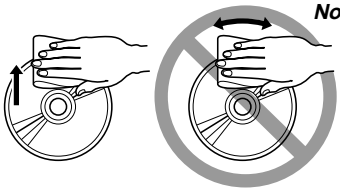

New discs may have some roughness around the edges. The unit may not work or the sound may skip if such discs are used. Use a ball-point pen, etc. to remove roughness from the edge of the disc.

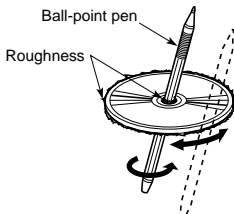

Note on Compact Discs

Never stick labels on the surface of the compact disc or mark the surface with a pencil or pen.

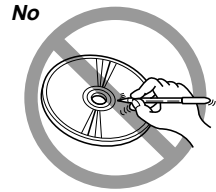

Do not use any solvents such as commercially available cleaners, anti-static spray, or thinner to clean compact discs.

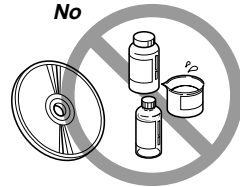

Do not use compact discs that have large scratches, are misshapen, or cracked, etc. Use of such discs will cause misoperation or damage.

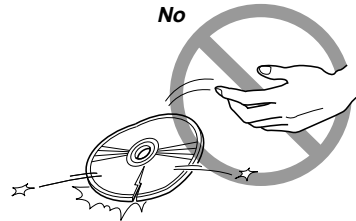

Do not expose compact discs to direct sunlight or any heat source.

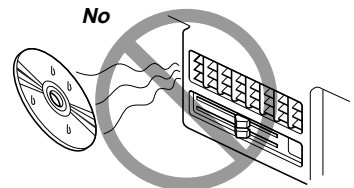

Note:

- Do not use commercially available CD protection sheets or discs equipped with stabilizers, etc. These may get caught in the internal mechanism and damage the disc.

6. DCP (Detachable Control Panel)

The control panel can be detached to prevent theft. When detaching the control panel, store it in the included DCP case to prevent scratches. We recommend taking the detachable control panel with you when leaving the car.

Removing the DCP

1. Turn off the power.
2. Press the DCP Release button **1**.

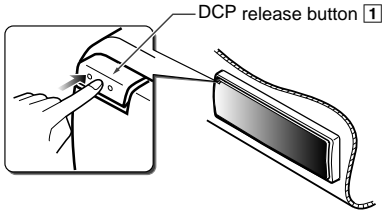

3. Remove the DCP.

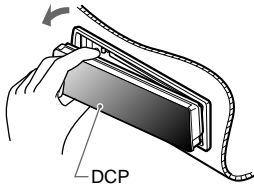

* The DCP is unlocked.

Attaching the DCP

Insert the DCP into the right side of the source unit and press the left side to lock it.

CAUTION

Do not insert the DCP from the left side. Doing so may damage it.

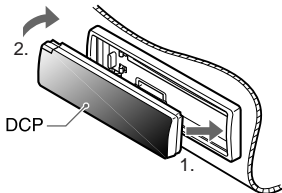

Storing the DCP in the DCP Case

Hold the DCP, in the orientation as shown in the figure below, and put it into the supplied DCP case. (Ensure the DCP is in the correct orientation.)

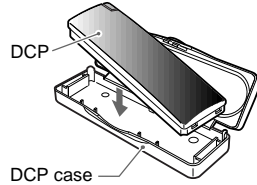

CAUTION

- The DCP can easily be damaged by shocks. After removing it, place it in a protective case and be careful not to drop it or subject it to strong shocks.
- When the release button is pressed and the DCP is unlocked, the car's vibrations may cause it to fall. To prevent damage to the DCP, always store it in a protective case after detaching it.
- The rear connector that connects the source unit and the DCP is an extremely important part. Be careful not to damage it by pressing on it with fingernails, pens, screwdrivers, etc.

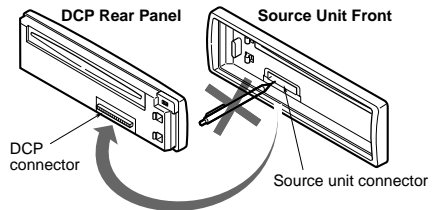

Note:

- If the DCP is dirty, wipe off with a soft, dry cloth only.

7. REMOTE CONTROL

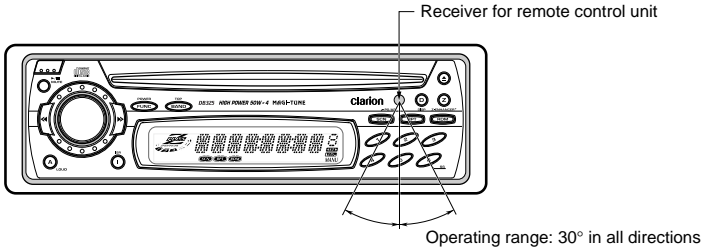

Remote Control Unit

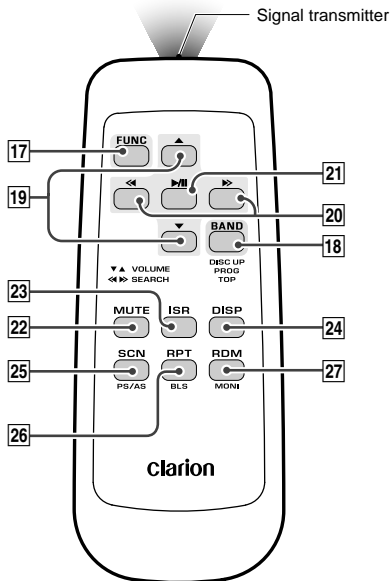

Inserting the Batteries

1. Turn the remote control unit over, then slide the rear cover in the direction of the arrow.
2. Insert the AA (UM-3/1.5 V) batteries that came with the remote control unit facing in the directions shown in the figure, then close the rear cover.

Notes:

Using batteries improperly can cause them to explode. Take note of the following points:

- When replacing batteries, replace both batteries with new ones.
- Do not short-circuit, disassemble or heat batteries.
- Do not dispose of batteries into fire or flames.
- Dispose of spent batteries properly.

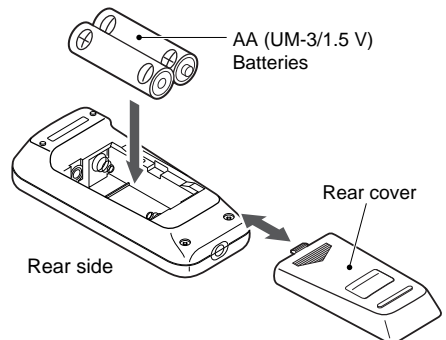

Functions of Remote Control Unit Buttons

Button	Mode	Radio	CD
17	FUNC	Turns power on and off. When pressed and held for 1 second: Turns power off. Switches between radio and CD.	
18	BAND DISC UP PROG TOP	Switches reception band.	Plays the first track. Top play.
19	VOLUME	Increases and decreases volume (in all modes).	
20	SEARCH	Moves preset channels up and down.	Moves tracks up and down. When pressed and held for 1 second: Fast-forward/ fast-backward.
21	PLAY/PAUSE	Turns mute on and off.	Switches between playback and pause.
22	MUTE	Turns mute on and off.	Switches between playback and pause.
23	ISR	Recalls ISR radio station in memory. Press and hold for more than 2 seconds: Stores current station into ISR memory (radio mode only).	
24	DISP	Switches among main display, sub display and clock display.	
25	SCN PS/AS	Preset scan. When pressed and held for 2 seconds: Auto store.	Scan play.
26	RPT BLS	No function.	Repeat play.
27	RDM MONI	No function.	Random play.

* Some of the corresponding buttons on the source unit and remote control unit have different functions.

8. OPERATION

Note:

- Be sure to read this chapter referring to the front diagrams of chapter 2. CONTROLS on page 3 (unfold).

Basic Operations

⚠ CAUTION

When this unit is turned on, starting and stopping the engine of a car with its volume raised to the maximum level may harm your hearing. Be careful about adjusting the volume.

Turning ON the Power and Adjusting the Volume

- 1) Press the POWER button [3].
 - * To turn off the power, press the POWER button [3] for 1 second or longer.
- 2) Press the FUNC button [3] and select another operation mode. Every time the FUNC button [3] is pressed, the display changes the operation mode as:
Radio → CD → Radio

Note:

- If the CD mode is selected when no disc is inserted, the display shows "NO DISC".
- 3) Turning the Rotary knob [14] clockwise increases the volume; turning it counterclockwise decreases the volume.
 - * The volume level is from 0 (minimum) to 33 (maximum).

Setting the Z-enhancer Plus

This unit comes with 4 types of sound tone effects stored in memory. Select the one you prefer.

* The factory default setting is "CUSTOM".

Each time you press Z button [9], the tone effect changes in the following order:

"B-BOOST" → "IMPACT" → "EXCITE" → "CUSTOM" → "Z+ OFF" → "B-BOOST" ...

- B-BOOST : bass emphasized
- IMPACT : treble emphasized
- EXCITE : bass and treble emphasized
- CUSTOM : bass and treble adjustment
- Z+ OFF : no sound effect

Adjusting the Tone

Press A button [15] and select the item to adjust. Each time you press A button [15], the item changes in the following order:

● When "B-BOOST" is set
"B-BOOST" → "BAL" → "FAD" → Previous mode

When "B-BOOST" is set, the bass adjustment value can be adjusted in the range of -3 to +3 by rotating the Rotary knob [14] clockwise or counterclockwise.

● When "IMPACT" is set
"IMPACT" → "BAL" → "FAD" → Previous mode

When "IMPACT" is set, the treble adjustment value can be adjusted in the range of -3 to +3 by rotating the Rotary knob [14] clockwise or counterclockwise.

● When "EXCITE" is set
"EXCITE" → "BAL" → "FAD" → Previous mode

When "EXCITE" is set, the bass and treble adjustment value can be adjusted in the range of -3 to +3 by rotating the Rotary knob [14] clockwise or counterclockwise.

● When "CUSTOM" is set
"BASS" → "TREB" → "BAL" → "FAD" → Previous mode

● When "Z+ OFF" is set
"BAL" → "FAD" → Previous mode

When the Z button [9] is pressed and hold for 1 second or longer with the tone effect set to "B-BST", "IMPACT" or "EXCITE", the sound characteristics become flat and the indication "FLAT" is shown in the display.

Adjusting the Bass

This adjustment can be performed when the Z-enhancer Plus is set to "CUSTOM".

- 1) Press A button [15] and select "BASS".
- 2) Turning Rotary knob [14] clockwise emphasizes the bass; turning it counterclockwise attenuates the bass.
 - * The factory default setting is "0". (Adjustment range: -6 to +6)
- 3) When the adjustment is complete, press A button [15] several times until the function mode is reached.

Adjusting the Treble

This adjustment can be performed when the Z-enhancer Plus is set to "CUSTOM".

- 1) Press A button **[15]** and select "TREB".
- 2) Turning Rotary knob **[14]** clockwise emphasizes the treble; turning it counterclockwise attenuates the treble.
 - * The factory default setting is "0". (Adjustment range: -6 to +6)
- 3) When the adjustment is complete, press A button **[15]** several times until the function mode is reached.

Adjusting the Balance

- 1) Press A button **[15]** and select "BAL".
- 2) Turning the Rotary knob **[14]** clockwise emphasizes the sound from the right speaker; turning it counterclockwise emphasizes the sound from the left speaker.
 - * The factory default setting is "0". (Adjustment range: L13 to R13)
- 3) When the adjustment is complete, press A button **[15]** several times until the function mode is reached.

Adjusting the Fader

- 1) Press A button **[15]** and select "FAD".
- 2) Turning the Rotary knob **[14]** clockwise emphasizes the sound from the front speakers; turning it counterclockwise emphasizes the sound from the rear speakers.
 - * The factory default setting is "0". (Adjustment range: F12 to R12)
- 3) When the adjustment is complete, press A button **[15]** several times until the function mode is reached.

Loudness Effect

In order to turn on/off the loudness effect, use the LD button **[15]** for 1 second or longer. Every time the LD button **[15]** is pressed and held for 1 second or longer, the loudness effect switches on and off.

* When the loudness effect is on, the display will show "LD".

Switching the Clock Display

Every time the DISP button **[7]** is pressed, the display will change between the operation mode and the clock display.

Setting the Clock

- 1) Press the DISP button **[7]** to display the clock display.
- 2) Press and hold the DISP button **[7]** for 1 second or longer.
- 3) Press the SRCH Left button **[2]**, then set the current hour.
- 4) Press the SRCH Right button **[2]**, then set the current minute.
- 5) Press the DISP button **[7]**, then the clock is set.

Notes:

- If you select another operation mode while you are setting the clock, the clock setting operation will be canceled.
- If you remove the vehicle's battery for a check or repair, the clock will be reset, so you must set it again.

Turning the screen saver function on or off

This unit is equipped with the function which enables you to display a variety of patterns and characters in the Operation status indication **[2]** in a random order. You can turn this function on or off.

* The factory default setting is on.

While pressing the Disp button **[7]**, press the SS button **[11]** to switch the function.

* The following illustration shows one of the patterns displayed when the screen saver function is set to on.



Radio Mode Operations

FM Reception

For enhanced FM performance the **MAGI-TUNE®** tuner includes signal actuated stereo control and Multipath noise reduction circuits.

Listening to the Radio

- 1) Press the FUNC button [3] to select the radio mode, then the radio will be on.
- 2) To select a preset band, press the BAND button [4], then select one of the preset bands such as FM1, FM2, FM3, or AM. Every time the BAND button [4] is pressed, the display will change as:
F1 (FM1) → F2 (FM2) → F3 (FM3) → AM → F1 (FM1)
- 3) Press the SRCH Left/Right button [2], then the station at which there is a broadcast will be selected (Seek selection).

Mute

Use this function to turn off the sound immediately.

Press the MUTE button [16]. The sound turns off and "MUTE" appears on the display. Press the MUTE button again to cancel the mute mode.

Manual Tuning

- 1) Press the BAND button [4], then select FM1, FM2, FM3 or AM.
- 2) Press and hold the BAND button [4] for 1 second or longer, then the display will show "MANU", which means that a manual selection function is on.
- 3) Press the SRCH Left/Right button [2] and select the right station.

Seek Tuning

- 1) Press the BAND button [4], then select FM1, FM2, FM3 or AM.
- 2) If the "MANU" on the display is on, press and hold the BAND button [4] for 1 second or longer. When the "MANU" display is off, the Seek Selection function is on.
- 3) Press the SRCH Left/Right button [2], then when it selects the station in which there is a broadcast, it automatically stops.

Preset Memory Function

Preset Memory Function can store up to 24 stations: six stations for each of FM1, FM2, FM3 and AM.

Note:

- When the present memory function is used, all the content of the memory will be erased.

Manual memory function

- 1) Press the BAND button [4], and select the band you want to store in the memory.
- 2) Press the SRCH Left/Right button [2] then select the station you want to store in the memory.
- 3) Press and hold the Preset button [12] for 2 seconds or longer, then the station will be stored in the memory.

Auto store function (Automatic Station Store)

- 1) Press the BAND button [4], then select the band you want to store in the memory.
- 2) Press and hold the AS button [5] for 2 seconds or longer, then the station at which the reception is the strongest will be automatically stored in the memory.

Note:

- When the number of stations stored is less than six, the previous content of the memory for each direct button will be retained.

Preset Scanning (Preset Station Scan)

When the PS button [5] is pressed, the preset memory numbers flash and the stations are tuned in for 7 seconds each in the order in which they were stored. Press the PS button [5] again to cancel the preset scanning mode.

Instant Station Recall (ISR)

With this function, a specific radio station can be recalled from any mode.

ISR memory

- 1) Press the FUNC button [3], then select the radio mode.
- 2) Select the radio station which you want to store in the memory.
- 3) Press and hold the ISR button [13] for 2 seconds or longer.

Recalling ISR

Press the ISR button [13] then the display will show "ISR", then the radio station previously memorized will be selected. Press the ISR button [13] again to disengage the unit from the Recalling ISR function.

Area Change

Use this function when you are using the car stereo anywhere outside the U.S.

Switchable frequency spacing

This car stereo is initially set to tune in frequency intervals of 10 kHz for AM and 200 kHz for FM, the standard calibrations in the U.S. When using the unit outside the U.S., use the following procedure to switch the frequency range. The table below lists the frequency specifications for the U.S. and other countries.

		Initial Setting (U.S. standard)	New Setting (outside U.S.)
AM	Frequency spacing	10 kHz	9 kHz
	Frequency range	530 to 1,710 kHz	531 to 1,629 kHz
FM	Frequency spacing	200 kHz	50 kHz
	Frequency range	87.9 to 107.9 MHz	87.5 to 108 MHz

Switching the area change Outside U.S. (New Setting)

While pressing the BAND button [4], press the SRCH Left button [2], then "outside U.S." will be selected.

Inside U.S. standard (Initial Setting)

While pressing the BAND button [4], press the SRCH Right button [2], then the "U.S. standard" will be selected.

CD Mode Operations

Loading a Disc

Insert the disc into the CD insertion slot with its label side up, then the CD will start playing.

For 5-inch (12 cm) CD For 3-inch (8 cm) single CD

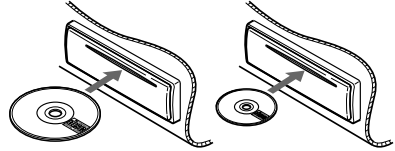

- * When inserting a single CD (3"(8 cm)), insert it from the center of the slot.
- * When inserting a single CD (3"(8 cm)), do not connect an adapter.

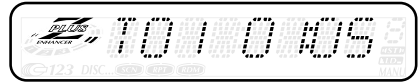

- * Press the DISP button [7], then the display will show the play time.

Notes:

- Some CDs recorded in CD-R/CD-RW mode may not be usable.

Listening to the Disc already Inserted

Press the FUNC button [3] to select the CD mode, the CD will start playing.

Stopping (pausing) Playback

Press the Play/Pause button [16].

Press the Play/Pause button [16] again to resume playback.

Ejecting the CD

Press the Eject button [8], then the CD will be ejected.

Note:

- If the ejected CD is left as it is, it will be reloaded after 15 seconds. However, single CDs will not be reloaded, so make sure to remove them.

Top Function

The top function allows the first track of the current CD to be played.

Press Top button **[4]** to play the first track (track No.1) of CD.

Selecting Tracks (songs)

Press the SRCH Left/Right button **[2]**.

▶▶: Playback will start from the next track.

◀◀: Playback will start from the beginning of the track currently playing. When this button is pressed again, the CD will play from the previous track.

Fast-Forward and Fast-Backward

Press and hold the SRCH Left/Right button **[2]**.

▶▶: To fast-forward

◀◀: To fast-backward

* Pressing the SRCH Left/Right button for 1 second or longer will move forward or backward 5 times faster than normal play, and pressing it for 3 seconds or longer will do the operation 30 times faster.

Scan Play (Intro Music Scan)

Press the SCN button **[5]**, then the display shows "SCN", then the CD will play the first 10 seconds of each track of the whole disc. Press the SCN button **[5]** again to disengage the unit from scan play.

* A scan play will start from the track following the one currently playing.

Repeat Play

Press the RPT button **[6]**, then the display shows "RPT", then the track currently playing will be played repeatedly. Press the RPT button **[6]** again to disengage the unit from repeat play.

Random Play

Press the RDM button **[10]**, then the display will show "RDM", then the entire tracks on the disc will be played at random. Press the RDM button **[10]** again to disengage the unit from random play.

9. TROUBLESHOOTING

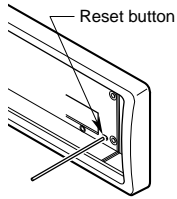
Problem	Cause	Solution
Power does not turn on. (No sound is produced.)	Fuse is blown.	Replace with a fuse of the same amperage. If the fuse blows again, consult your store of purchase.
	Incorrect wiring.	Consult your store of purchase.
Compact disc cannot be loaded.	Another compact disc is already loaded.	Eject the compact disc before loading the new one.
Sound skips or is noisy.	Compact disc is dirty.	Clean the compact disc with a soft cloth.
	Compact disc is heavily scratched or warped.	Replace with a compact disc with no scratches.
Sound is bad directly after power is turned on.	Water droplets may form on the internal lens when the car is parked in a humid place.	Let dry for about 1 hour with the power on.
Nothing happens when buttons are pressed. Display is not accurate.	Microprocessor has malfunctioned due to noise, etc.	Turn off the power, then press the DCP Release button 1 and remove the DCP. Press the reset button for about 2 seconds with a thin rod. 
	DCP or source unit connectors are dirty.	Wipe the dirt off with a soft cloth moistened with cleaning alcohol.

10. ERROR DISPLAYS

If an error occurs, one of the following displays is displayed.
Take the measures described below to eliminate the problem.

	Error Display	Cause	Measure
CD	CD ER2	A CD is caught inside the CD deck and is not ejected.	This is a failure of CD deck's mechanism and consult your store of purchase.
	CD ER3	A CD cannot be played due to scratches, etc.	Replace with a non-scratched, non-warped-disc.
	CD ER6	A CD is loaded upside-down inside the CD deck and does not play.	Eject the disc then reload it properly.

If an error display other than the ones described above appears, press the reset button. If the problem persists, turn off the power and consult your store of purchase.

11. SPECIFICATIONS

FM Tuner

Frequency Range: 87.9 MHz to 107.9 MHz
Usable Sensitivity: 11 dBf
50 dB Quieting Sensitivity: 17 dBf
Alternate Channel Selectivity: 75 dB
Stereo Separation (1 kHz): 35 dB
Frequency Response (± 3 dB): 30 Hz to 15 kHz

AM Tuner

Frequency Range: 530 kHz to 1,710 kHz
Usable Sensitivity: 25 μ V

CD Player

System: Compact disc audio system
Usable Discs: Compact disc
Frequency Response: 10 Hz to 20 kHz (± 1 dB)
Signal-to-Noise Ratio: 100 dB (1 kHz) IHF-A
Dynamic Range: 95 dB (1 kHz)
Harmonic Distortion: 0.01%

Audio

Maximum Power Output:
200 W (50 W \times 4 ch)
Continuous Average Power Output:
18 W \times 4, into 4 Ω , 20 Hz to 20 kHz, 1%THD
Bass Control Action (30 Hz): ± 12 dB
Treble Control Action (10 kHz): ± 10 dB
Line Output (CD 1 kHz, 10 k Ω): 1.8 V

General

Power Supply Voltage: 14.4 V DC (10.8 V to 15.6 V allowable), negative ground
Current Consumption: Less than 15 A
Speaker Impedance: 4 Ω (4 Ω to 8 Ω allowable)
Weight: 3.97 lb. (1.8 kg)
Dimensions:

7" (178 mm) Width \times 2" (50 mm) Height \times 6-1/8" (155 mm) Depth

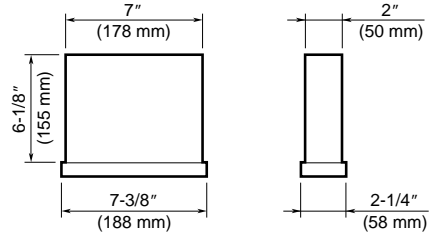

Notes:

- Specifications and design are subject to change without notice for further improvement.

Free Manuals Download Website

<http://myh66.com>

<http://usermanuals.us>

<http://www.somanuals.com>

<http://www.4manuals.cc>

<http://www.manual-lib.com>

<http://www.404manual.com>

<http://www.luxmanual.com>

<http://aubethermostatmanual.com>

Golf course search by state

<http://golfingnear.com>

Email search by domain

<http://emailbydomain.com>

Auto manuals search

<http://auto.somanuals.com>

TV manuals search

<http://tv.somanuals.com>