

clarion

Owner's manual / Mode d'emploi
Bedienungsanleitung / Istruzioni per l'uso
Gebruiksaanwijzing / Manual de instrucciones
Bruksanvisning / Manual de instruções

DB358RMP

CD/MP3 RECEIVER

•

RADIO CD/MP3

•

CD/MP3-RECEIVER

•

RICEVITORE PER CD/MP3

•

CD/MP3-RECEIVER

•

RADIO CD/MP3

•

CD/MP3-LÄSARE

•

RECEPTOR CD/MP3

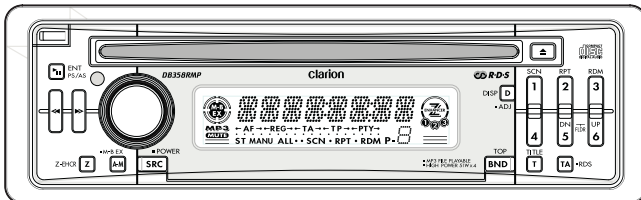

COMPACT
disc
DIGITAL AUDIO

MP3
ID3 TAG

R-D-S
EON

ISO
CONNECTOR

Thank you for purchasing this **Clarion** product.

- * Please read this owner's manual in its entirety before operating this equipment.
- * After reading this manual, be sure to keep it in a handy place (e.g., glove compartment).
- * Check the contents of the enclosed warranty card and keep it carefully with this manual.

CAUTIONS:

This appliance contains a laser system and is classified as a "CLASS 1 LASER PRODUCT". To use this model properly, read this Owner's Manual carefully and keep this manual for your future reference. In case of any trouble with this player, please contact your nearest "AUTHORIZED service station". To prevent direct exposure to the laser beam, do not try to open the enclosure.

!CAUTION

USE OF CONTROLS OR ADJUSTMENTS OR PERFORMANCE OF PROCEDURES OTHER THAN THOSE SPECIFIED IN THE OWNER'S MANUAL MAY RESULT IN HAZARDOUS RADIATION EXPOSURE.

ADVARSEL.

Denne mærking er anbragt udvendigt på apparatet og indikerer, at apparatet arbejder med laserstråler af klasse 1, hvilket betyder, at der anvendes laserstråler af svageste klasse, og at man ikke på apparatets yderside kan blive udsat for utilladelig kraftig stråling.

APPARATET BØR KUN ÅBNES AF FAGFOLK MED SÆRLIGT KENDESKAB TIL APPARATER MED LASERSTRÅLER!

Indvendigt i apparatet er anbragt den her gengivne advarselsmærkning, som advarer imod at foretage sådanne indgreb i apparatet, at man kan komme til at udsætte sig for laserstråling.

OBS!

Apparaten innehåller laserkomponenten som avger laserstråling överstigande gränsen för laserklass 1.

VAROITUS

Suojakoteloa si saa avata. Laite sisältää laseriodin, joka lähettää näkymätöntä silmille vaarallista lasersäteilyä.

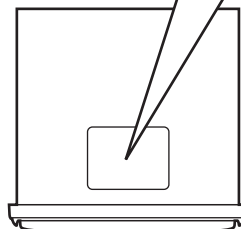

Contents

1. PRECAUTIONS	3
Handling Compact Discs	4
2. CONTROLS	5
3. NOMENCLATURE	6
Names of the Buttons and their Functions	6
Display Items	7
LCD Screen	7
4. REMOTE CONTROL (Optional item)	8
Functions of Remote Control Unit Buttons	9
5. DCP	10
6. OPERATIONS	11
Basic Operations	11
Radio Operations	13
RDS Operations	15
CD Mode Operations	17
MP3 Mode Operations	18
7. IN CASE OF DIFFICULTY	21
8. ERROR DISPLAYS	21
9. SPECIFICATIONS	22

1. PRECAUTIONS

- When the inside of the car is very cold and the player is used soon after switching on the heater moisture may form on the disc or the optical parts of the player and proper playback may not be possible. If moisture forms on the disc, wipe it off with a soft cloth. If moisture forms on the optical parts of the player, do not use the player for about one hour. The condensation will disappear naturally allowing normal operation.
- Driving on extremely bumpy roads which cause severe vibration may cause the sound to skip.
- This unit is applicable for on-road 4 wheel vehicle purpose only. Use for tractor, fork truck, bulldozer, off road vehicle, 2 or 3 wheel motor bicycle, marine boat or other special purpose vehicle is not appropriate.

INFORMATION FOR USERS:

CHANGES OR MODIFICATIONS TO THIS PRODUCT NOT APPROVED BY THE MANUFACTURER WILL VOID THE WARRANTY.

English

Handling Compact Discs

This unit has been designed specifically for playback of compact discs bearing the  mark. No other discs can be played.

To remove the compact disc from its storage case, press down on the center of the case and lift the disc out, holding it carefully by the edges.

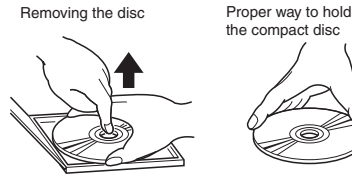

Always handle the compact disc by the edges. Never touch the surface.

To remove fingermarks and dust, use a soft cloth, and wipe in a straight line from the center of the compact disc to the circumference.

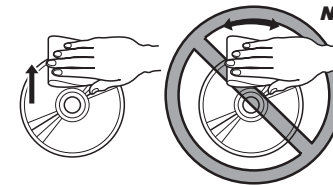

New discs may have some roughness around the edges. The unit may not work or the sound may skip if such discs are used. Use a ball-point pen, etc. to remove roughness from the edge of the disc.

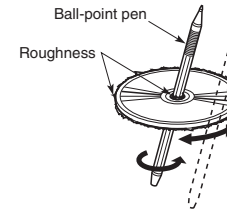

Note:

- Do not use commercially available CD protection sheets or discs equipped with stabilizers, etc. These may get caught in the internal mechanism and damage the disc.

Be sure to unfold and read the next page. / Veuillez déplier et vous référer à la page suivante.
Bitte ausbreiten und die nächste Seite lesen. / Assicurarasi di aprire e leggere la pagina successiva.
Volgende pagina uitvouwen en doorlezen a.u.b. / Cerciórese de desplegar y de leer la página siguiente.
Glöm inte att vika ut och läsa nästa sida. / Não deixe de abrir e ler a próxima página.

Note on compact discs

Never stick labels on the surface of the compact disc or mark the surface with a pencil or pen.

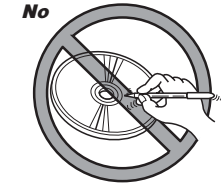

Do not use any solvents such as commercially available cleaners, anti-static spray, or thinner to clean compact discs.

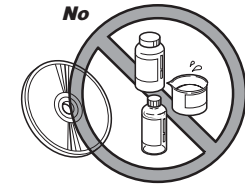

Do not use compact discs that have large scratches, are misshapen, or cracked, etc. Use of such discs will cause misoperation or damage.

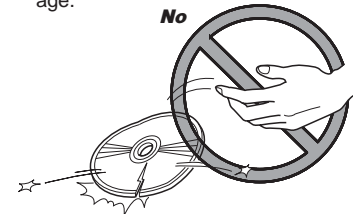

Do not expose compact discs to direct sunlight or any heat source.

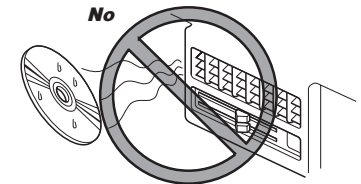

2. CONTROLS / LES COMMANDES / REGLER / CONTROLLI REGELAARS / CONTROLES / KONTROLLER / CONTROLOS

Main unit / Appareil principal / Hauptgerät / Apparechio principale
Hoofdtoestel / Unidad principal / Huvudenhet / Unidade principal

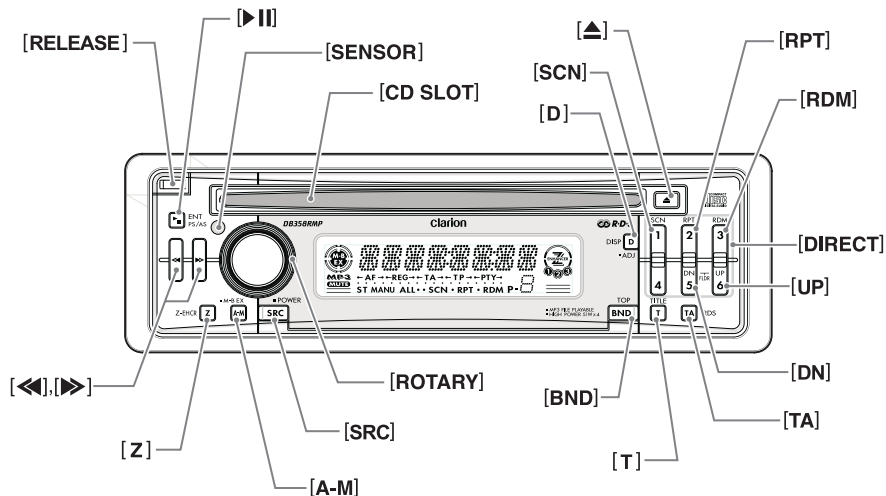

Note: Be sure to unfold this page and refer to the front diagrams as you read each chapter.

Remarque: Veuillez déplier cette page et vous référer aux schémas quand vous lisez chaque chapitre.

Hinweis: Bitte diese Seite ausfallen und beim Lesen der einzelnen Kapitel die Frontdiagramme beachten.

Nota: Assicurarsi di aprire questa pagina e fare riferimento a questi diagrammi quando si legge ciascun capitolo.

Opmerking: Vouw deze pagina uit en zie tevens de afbeeldingen van het voorpaneel tijdens het doorlezen van de volgende hoofdstukken.

Nota: Cuando lea los capítulos, despliegue esta página y consulte los diagramas.

Observera: Vik ut denna sida för att kunna se figurerna över bilstereons framsida medan du läser de olika kapitlen.

Nota: Certifique-se de abrir esta página e consulte os diagramas frontais conforme realiza a leitura de cada capítulo.

3. NOMENCLATURE

Note:

- Be sure to read this chapter referring to the front diagrams of chapter "2. CONTROLS" on page 5 (unfold).

Names of the Buttons and their Functions

[RELEASE] button

- Press the [RELEASE] button to unlock the DCP.

[▶||] button

- Plays or pauses a CD while in the CD mode.
- To enter various setting.
- Performs preset scan while in the radio mode. When the button is pressed and held, auto store is performed.

[SENSOR] button

- Receiver for remote control unit.
- Operating range: 30° in all directions.

[CD SLOT]

- CD insertion slot.

[▲] button

- Ejects a CD when it is loaded into the unit.

[D] button

- Switch the display indication (Main display, clock display).

MP3 FUNCTION-DISPLAY SELECTION

- Display changes in the following order:
Track No. / Play time → Folder No. / Track No.
→ Title Display → Clock Display → Track No. / Play time...
- Long press to enter adjustment mode.

[SCN] button

- Performs scan play for 10 seconds for each track while in the CD mode.

[RPT] button

- Plays repeatedly while in the CD mode.

[RDM] button

- Performs random play while in the CD mode.

[UP] button

- Play first track of next folder which contain MP3 files.*
- * Key function only available after MP3 indicator turned on.

[DN] button

- Play first track of previous folder which contain MP3 files.*
- * Key function only available after MP3 indicator turned on.

[DIRECT] button

- Stores a station into memory or recall it directly while in the radio mode.

[TA] button

- Use the button to set the TA (Traffic Announcement) standby mode.
- Long press to enter RDS mode.

[T] button

- Switches MP3 TITLE display.
- Press and hold for 1 second to scroll display data.

[BND] button

- Switches the band, or seek tuning or manual tuning while in the radio mode.
- Plays a first track while in the CD mode.
- Press and hold the button to select between CD-DA playback and MP3 playback in Multisession CD.

[ROTARY] knob

- Adjust the volume by turning the knob clockwise or counterclockwise.
- Use the knob to perform various settings.

[SRC] button

- Press the button to turn on the power. Press and hold the button for 1 second or longer to turn off the power.
- Switches the operation mode among radio and CD/MP3 mode.

[A-M] button

- Press and hold the button for 1 second or longer to switch the MAGNA BASS EX on/off.
- Use the button to switch to the audio mode (bass/treble, balance/fader)

[Z] button

- Use the button to select one of the three types of sound characteristics already stored in memory. (Z-Enhancer)

[◀], [▶] button

- Selects a station while in the radio mode or selects a track when listening to a CD.
- Press and hold the button for 1 second or longer to switches the fast-forward/fast-backward.

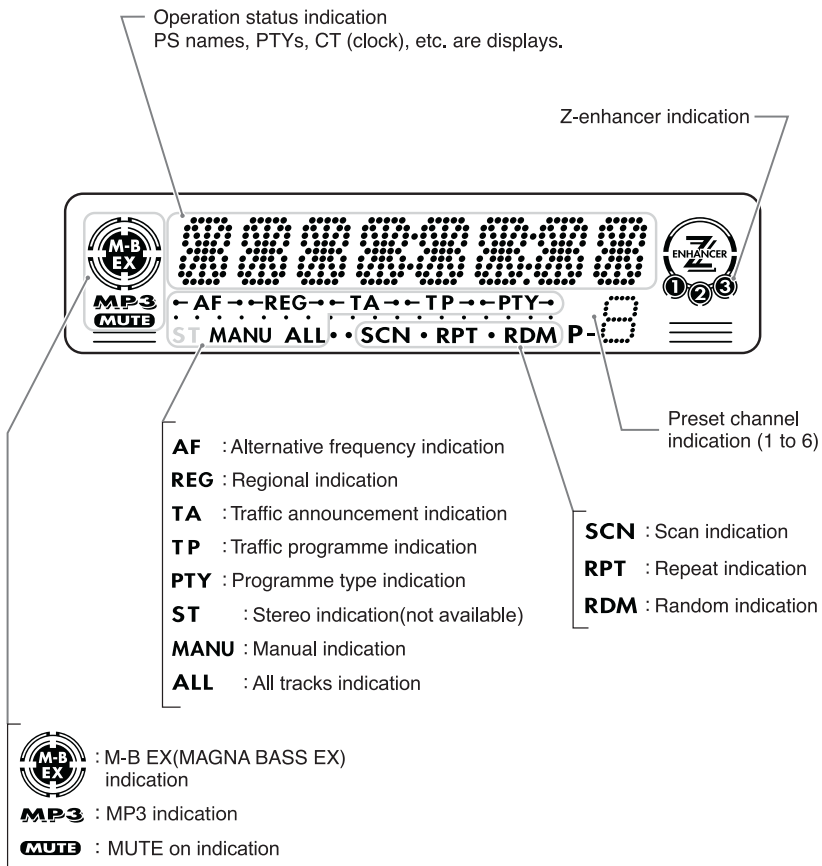

LCD Screen

In extreme cold, the screen movement may slow down and the screen may darken, but this is normal. The screen will recover when it returns to normal temperature.

4. REMOTE CONTROL (Optional item)

If you buy the RCB-172-200 sold separately, you can enjoy the use of the Remote Control function.

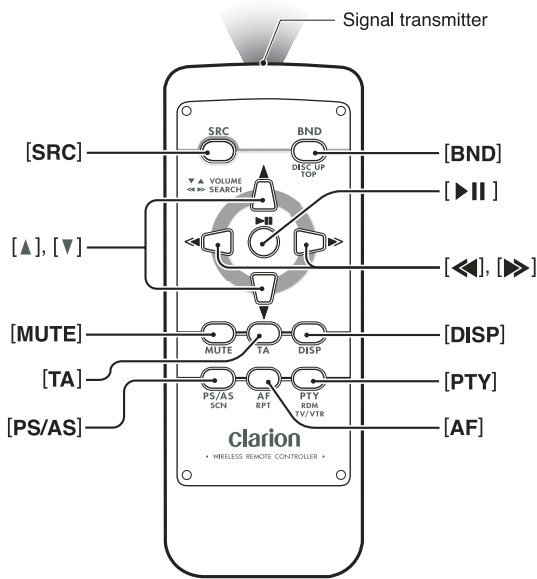

Inserting the Battery

1. Turn over the remote control unit and slide the cover in the direction indicated by the arrow in the illustration.
2. Insert the battery (CR2025) into the insertion guides, with the printed side (+) facing upwards.
3. Press the battery in the direction indicated by the arrow so that it slides into the compartment.
4. Replace the cover and slide in until it clicks into place.

Notes:

Misuse may result in rupture of the battery, producing leakage of fluid and resulting in personal injury or damage to surrounding materials. Always follow these safety precautions:

- Use only the designated battery .
- When replacing the battery, insert properly, with +/- polarities oriented correctly.
- Do not subject battery to heat, or dispose of in fire or water. Do not attempt to disassemble the battery.
- Dispose of used batteries properly.

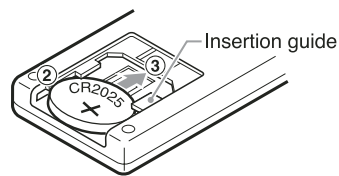
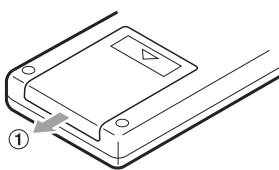

Functions of Remote Control Unit Buttons

Mode Button	Radio	CD	MP3
[SRC]	Turns power on and off. When press and held for 1 second: Turns power off. Switches between radio and CD/MP3.		
[BND]	Switches reception band.	Plays the first track. Top play.	Plays the first track of the current folder.
[▲], [▼]	Increases and decreases volume (in all modes).		
[◀], [▶]	Moves preset channels up and down.	Moves tracks up and down. When pressed and held for 1 second: Fast-forward/ fast-backward.	
[▶]	Turns mute on and off	Switches between playback and pause.	
[MUTE]	Turns mute on and off.	Switches between playback and pause.	
[TA]	Recalls ISR radio station in memory. Press and hold for 2 seconds or longer: Stores current station into ISR (radio mode only).		
[DISP]	Switches among main display, clock display.		Switch among main display, folder number display, TITLE display, clock display.
[PS/AS]	Preset scan. When pressed and held for 1 second: Auto store.	Scan play.	Scan play. When pressed and held for 1 second: Folder scan.
[AF]	No function	Repeat play.	Repeat play. When pressed and held for 1 second: Folder repeat.
[PTY]	No function	Random play.	Random play. When pressed and held for 1 second: Folder random.

* Some of the corresponding buttons on the main unit and remote control unit have different functions.

5. DCP

The control panel can be detached to prevent theft. When detaching the control panel, store it in the DCP (Detachable Control Panel) case to prevent scratches.

We recommend taking the DCP with you when leaving the car.

Removing the DCP

1. Press the [SRC] button for 1 second or longer to switch off the power.
2. Press in the [RELEASE] button.

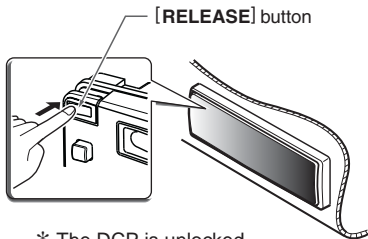

3. Remove the DCP.

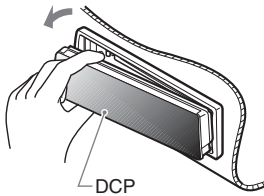

Attaching the DCP

1. Insert the right side of the DCP into the main unit.
2. Insert the left side of the DCP into the main unit.

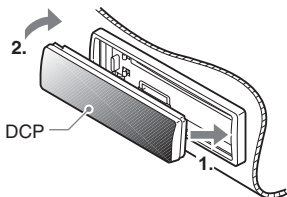

Storing the DCP in the DCP case

Hold the DCP, in the orientation as shown in the figure below, and put it into the supplied DCP case. (Ensure the DCP is in the correct orientation.)

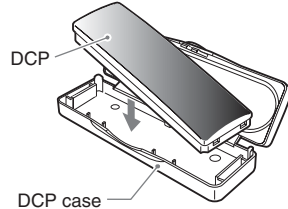

⚠ CAUTION

- The DCP can easily be damaged by shocks. After removing it, be careful not to drop it or subject it to strong shocks.
- When the Release button is pressed and the DCP is unlocked, the car's vibrations may cause it to fall. To prevent damage to the DCP, always store it in its case after detaching it. (See figure above.)
- The connector connecting the main unit and the DCP is an extremely important part. Be careful not to damage it by pressing on it with fingernails, pens, screwdrivers, etc.

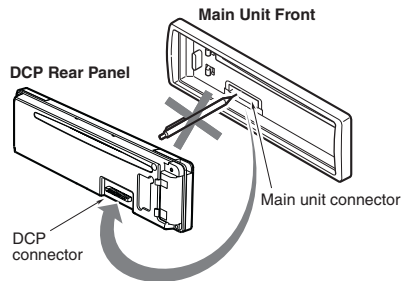

Note:

- If the DCP is dirty, wipe off the dirt with a soft, dry cloth only.

6. OPERATIONS

Basic Operations

Note: Be sure to read this chapter referring to the front diagrams of chapter "2. CONTROLS" on page 5 (unfold).

⚠ CAUTION

Be sure to lower the volume before switching off the unit power or the ignition key. The unit remembers its last volume setting. If you switch the power off with the volume up, when you switch the power back on, the sudden loud volume may hurt your hearing and damage the unit.

Turning on/off the power

Note:

- Be careful about using this unit for a long time without running the engine. If you drain the car's battery too far, you may not be able to start the engine and this can reduce the service life of the battery.
1. Press the [SRC] button.
 2. The illumination and display on the unit light up. The unit automatically remembers its last operation mode and will automatically switch to display that mode.
 3. Press and hold the [SRC] button for 1 second or longer to turn off the power for the unit.

Selecting a mode

1. Press the [SRC] button to change the operation mode.
2. Each time you press the [SRC] button, the operation mode changes in the following order:
Radio mode → CD mode → Radio mode...

Note:

- If the CD mode is selected when no disc is inserted, the display shows "NO DISC".

Adjusting the volume

Turning the [ROTARY] knob clockwise increases the volume; turning it counterclockwise decreases the volume.

- * The volume level is from 0 (minimum) to 33 (maximum).

Setting the Z-Enhancer

This unit is provided with 3 types of sound tone effects stored in memory. Select the one you prefer.

- * The factory default setting is Z-EHCR OFF.

Each time you press the [Z] button, the tone effect changes in the following order:

Z-ENHANCER 1 → Z-ENHANCER 2 → Z-ENHANCER 3 → Z-EHCR OFF → Z-ENHANCER 1...

- Z-ENHANCER 1 : bass emphasized
- Z-ENHANCER 2 : treble emphasized
- Z-ENHANCER 3 : bass and treble emphasized
- Z-EHCR OFF : no sound effect

Audio mode adjustments

1. Press the [A-M] button to select the adjustment mode. The mode switches as follows each time the [A-M] button is pressed:

BASS → TREB → BAL → FAD → Previous mode

- * When the Z-Enhancer function is turned on, BASS (Bass) and TREB (Treble) cannot be selected.

2. Turning the [ROTARY] knob to adjust the selected audio mode.

BASS (Bass) : Adjustment range: -7 to +7

TREB (Treble) : Adjustment range: -7 to +7

BAL (Balance) : Adjustment range: L13 to R 13

FAD (Fader) : Adjustment range: F12 to R12

3. When the adjustment is complete, press the [A-M] button several times until the function.

Basic Operations

Turning on/off MAGNA BASS EX

The MAGNA BASS EX does not adjust the low sound area like the normal sound adjustment function, but emphasizes the deep bass sound area to provide you with a dynamic sound.

* The factory default setting is off.

Press and hold the [A-M] button for 1 second or longer to turn the MAGNA BASS EX and "M-B EX" in the display lights on or off.

Switching display

Press the [D] button to select the desired display. The display switches in the following order:

Main Display → Clock (CT) Display →

Main Display ...

* If the display is changed by other button operation when the clock (CT) is displayed, the clock display returns automatically after the operation.

CT (Clock Time) function

The CT function enables you to display clock time only when CT data is received.

Press the [D] button, the display switches to CT (Clock Time).

* When no CT data is received, "CT—:—" appears in the display.

Note:

- There are some countries and stations where clock time data are not transmitted. In some areas, the CT may not be displayed correctly.

Illumination dimmer function

When the illumination line of this unit is connected with the car-side illumination signal line, the display illumination of this unit dims in connection with turning on the car-side illumination.

ADJ mode adjustment

1. Press [D] button more than 1 second at POWER ON mode to enter ADJ mode, the previous selected ADJ items will be called out.
2. Press [D] button again at ADJ mode will cancel ADJ mode and return to previous display.
3. Press [SRC] button will also release ADJ mode.
4. ADJ mode will also be released when current source mode is changed. (Mode changes of LOADING, EJECT, interruption and interruption release)
5. Press [◀]/[▶] button to switch the ADJ mode items,

→SCRN SVR ↔ A-SCROLL ↔ TELSW←
6. The ADJ Mode Title will be display for 2 seconds before showing the ADJ Mode setting.

Adjusting screensaver setting

1. Press the [D] button and press [◀]/[▶] button to select "SCRN SVR".
2. "SS ON" or "SS OFF" will be display after 2 seconds.
3. Turn the [ROTARY] knob clockwise to turn on the screensaver or counterclockwise to turn off the screensaver.
4. If Screensaver setting is set to on, Screensaver will be activated after 30 seconds of no key operation.

Adjusting auto-scroll setting

1. Press the [D] button and press [◀]/[▶] button to select "A-SCROLL".
2. "SCRL ON" or "SCRL OFF" will be display after 2 seconds.
3. Turn the [ROTARY] knob clockwise to turn on the auto-scroll or counterclockwise to turn off the auto-scroll.
4. If Auto-Scroll setting is set to on, the MP3 Title will scroll continuously in MP3 Title Display Mode.

Basic Operations

Adjusting telephone interrupt setting

1. Press the [D] button and press [◀]/[▶] button to select "TEL-SW".
2. "TEL ON" or "TEL OFF" will be display after 2 seconds.
3. Turn the [ROTARY] knob clockwise to turn on the Tel Interrupt or counterclockwise to turn off the Tel Interrupt.
 - * During telephone interrupt, the display shows "TEL".

This unit requires special wiring to mute the audio signal automatically when a cellular telephone rings in the car.

- * This function is not compatible with all cellular telephones. Contact your local authorized Clarion dealer for information on proper installation and compatibility.
- * The factory default setting is "TEL OFF".

Radio Operations

Listening to the radio

1. Press the [SRC] button and select the radio mode. The frequency or PS appears in the display.
 - * PS: Programme service name
2. To select a preset band, press the [BND] button, then select one of the preset bands such as FM1, FM2, FM3 or AM. Every time the [BND] button is pressed, the display will change as: F1→F2→F3→AM→F1...
3. Press the [◀] or [▶] button to tune in the desired station.

Tuning

There are 3 types of tuning mode available, seek tuning, manual tuning and preset tuning.

Seek tuning

There are 2 types of seek tuning: DX SEEK and LOCAL SEEK.

DX SEEK can automatically tune in to receivable broadcast stations; LOCAL SEEK can tune in to only broadcast stations with a good reception sensitivity.

1. Press the [BND] button and select the desired band (FM or AM (MW, LW)).
2. Tune into a station.
 - * If "MANU" is lit in the display, press and hold the [BND] button for 1 second or longer.
 - * If "TA" is lit in the display, TP stations are automatically sought.

● DX SEEK

Press the [◀] or [▶] button to automatically seek a station.

When the [▶] button is pressed, the station is sought in the direction of higher frequencies; if the [◀] button is pressed, the station is sought in the direction of lower frequencies.

* When seek tuning starts, "DX" appears in the display.

● LOCAL SEEK

If you press and hold the [◀] or [▶] button for 1 second or longer, local seek tuning is carried out. Broadcast stations with good reception sensitivity are selected.

* When local seeking starts, "LO" appears in the display.

Radio Operations

Manual tuning

There are 2 ways available: Quick tuning and step tuning.

When you are in the step tuning mode, the frequency changes one step at a time. In the quick tuning mode, you can quickly tune the desired frequency.

1. Press the **[BND]** button and select the desired band (FM or AM (MW/LW)).
 - * If "MANU" is not lit in the display, press and hold the **[BND]** button for 1 second or longer. "MANU" is lit in the display and manual tuning is now available.
2. Tune into a station.
 - **Quick Tuning:**
Press and hold the **[◀▶]** or **[▶▶]** button for 1 second or longer to tune in a station.
 - **Step Tuning:**
Press the **[◀▶]** or **[▶▶]** button to manually tune in a station.

Recalling a preset station

A total of 24 preset positions (6-FM1, 6-FM2, 6-FM3, 6-AM) exists to store individual radio stations in memory. Pressing the corresponding **[DIRECT]** button recalls the stored radio frequency automatically.

1. Press the **[BND]** button and select the desired band (FM or AM (MW/LW)).
2. Press the corresponding **[DIRECT]** button to recall the stored station.
 - * Press and hold one of the **[DIRECT]** buttons for 1 second or longer to store that station into preset memory.

Manual memory

1. Select the desired station with seek tuning, manual tuning or preset tuning.
2. Press and hold one of the **[DIRECT]** buttons for 1 second or longer to store the current station into preset memory.

Auto store

Auto store is a function for storing up to 6 stations that are automatically tuned in sequentially. If 6 receivable stations cannot be received, a previously stored station remains unoverwritten at the memory position.

Notes:

- The only FM band that can store the stations will automatically be stored in FM3.
 - When the auto store is performed, the station previously stored in the memory at that position is overwritten.
 - If there are fewer than 6 stations with good reception, the stations previously stored at the remaining **[DIRECT]** buttons are not overwritten.
 - A station already stored in one of **[DIRECT]** buttons cannot be stored in another **[DIRECT]** buttons.
1. Press the **[BND]** button and select the desired band (FM or AM (MW/LW)).
 2. Press and hold the **[▶▶▶]** button for 1 second or longer. The stations with good reception are stored automatically to the preset channels.
 - * If auto store is performed in the FM bands, the stations are stored in FM3 even if FM1 or FM2 was chosen for storing stations.

Preset scan

Preset scan receives the stations stored in preset memory in order. This function is useful when searching for a desired station in memory.

1. Press the **[▶▶▶]** button.
2. When a desired station is tuned in, press the **[▶▶▶]** button again to continue receiving that station.

Note:

- Be careful not to press and hold the **[▶▶▶]** button for 1 second or longer, otherwise the auto store function is engaged and the unit starts storing stations.

RDS Operations

RDS (Radio Data System)

This unit has a built-in RDS decoder system that supports broadcast stations transmitting RDS data.

This system can display the name of the broadcast station being received (PS) and can automatically switch to the broadcast station with the best reception as you move long distances (AF switching).

Also, if a traffic announcement or programme type is broadcast from an RDS station, no matter what mode you are in, this broadcast is received.

Additionally, if EON information is received, this information enables automatic switching of other preset stations on the same network and interruption of the station being received with traffic information from other stations (TP). This function is not available in some areas.

When using the RDS function, always set the radio to FM mode.

- AF : Alternative Frequency
- PS : Programme Service Name
- PTY : Programme Type
- EON : Enhanced Other Network
- TP : Traffic Programme

* RDS interrupt does not function during AM radio reception.

Manually tuning a regional station in the same network

1. This function is valid when the AF function is ON and the REG function is OFF.

Note:

- This function can be used when a regional broadcast of the same network is received.
2. Press any one of the [DIRECT] buttons to call out the regional station.
 3. If the reception condition of the called out station is bad, press the [DIRECT] button of the same number. The unit receives a local station on the same network.

TA (Traffic Announcement)

In the TA standby mode, when a traffic announcement broadcast starts, the traffic announcement broadcast is received as top priority regardless of the function mode so you can listen to it. Traffic programme (TP) automatic tuning is also possible.

* This function can only be used when "TP" is lit in the display. When "TP" is lit, this means that the RDS broadcast station being received has traffic announcement programmes.

● Setting the TA standby mode

If you press the [TA] button when only "TP" is lit in the display, "TP" and "TA" light in the display and the unit is set into the TA standby mode until a traffic announcement is broadcast. When a traffic announcement broadcast starts, "TRA INFO" appears in the display. If you press the [TA] button while a traffic announcement broadcast is being received, the traffic announcement broadcast reception is cancelled and the unit goes into the TA standby mode.

● Cancelling the TA standby mode

With "TP" and "TA" lit in the display, press the [TA] button. The "TA" in the display goes off and the TA standby mode is cancelled.

* If "TP" is not lit, pressing the [TA] button searches for a TP station.

● Searching for a TP station

When "TP" is not lit, if you press the [TA] button, "TA" in the display lights and the unit automatically receives a TP station.

Note:

- If a TP station is not received, the unit continues the search operation. Pressing [TA] button again goes off "TA" in the display and stops TP station searching.

RDS MODE adjustment

Press and hold the [TA] button for 1 second or longer to select the RDS MODE.

The mode switches as follows each time the [◀] or [▶] buttons are pressed:

PTY ON ← → PTY-S<E>*1 ← → AF ON ← →
REG ON*2

Press [RDS] button to exit RDS MODE.

Note:

- *1"PTY-S<E>" only available when "PTY ON".
- *2"REG ON" only available when "AF ON".

Adjusting PTY

This function enables you to listen to a broadcast of the selected programme type when it starts even if the unit is on a function mode other than radio.

- * Some countries do not yet have PTY broadcast.
- * In the TA standby mode, a TP station has priority over a PTY broadcast station.

1. Press the **[TA]** button for 1 second or longer and press [**◀**]/[**▶**] button to select "PTY ON" or "PTY OFF".
2. Turning the **[ROTARY]** knob clockwise to "PTY ON"; or counterclockwise to "PTY OFF".

PTY selection

1. Press the **[TA]** button for 1 second or longer and press [**◀**]/[**▶**] button to select "PTY-S<E>". Press [**▶**||] to enter PTY selection mode.
2. Press any one of the **[DIRECT]** buttons. Alternatively, turn the **[ROTARY]** knob clockwise or counterclockwise to select the desired PTY.
 - * Below are the factory default settings stored for the **[DIRECT]** buttons.

Preset number	PTY item	
	ENGLISH	Contents
1	NEWS	News
2	INFO	Information
3	POP M	Pop Music
4	SPORT	Sport
5	CLASSICS	Serious Classical Music
6	EASY M	Easy Listening Music

3. The PTY select mode is cancelled automatically 7 seconds after a PTY is selected.

PTY seek

1. Select desired PTY item.
2. Press the [**◀**] or [**▶**] button. If you press the [**▶**] button, the unit seeks a PTY broadcast moving up the frequencies; if you press the [**◀**] button, it seeks moving down the frequencies.

PTY preset memory

1. Press the **[TA]** button for 1 second or longer and press [**◀**]/[**▶**] button to select "PTY-S<E>". Press [**▶**||] to enter PTY selection mode.
2. Turn the **[ROTARY]** knob clockwise or counterclockwise to select the desired PTY.

The 29 types of PTY below can be selected.

PTY item	
ENGLISH	Contents
NEWS	News
AFFAIRS	Today's events
INFO	Information
SPORT	Sports
EDUCATE	Education
DRAMA	Drama
CULTURE	Culture
SCIENCE	Science
VARIED	Variety
POP M	Pop music
ROCK M	Rock music
EASY M	Easy music
LIGHT M	Light music
CLASSICS	Classics
OTHER M	Other music
WEATHER	Weather
FINANCE	Finance
CHILDREN	For children
SOCIAL	Social
RELIGION	Religion
PHONE IN	Phone in
TRAVEL	Travel
LEISURE	Leisure
JAZZ	Jazz
COUNTRY	Country
NATION M	Nation music
OLDIES	Oldies
FOLK M	Folk music
DOCUMENT	Documentaries

3. If you press and hold any one of the **[DIRECT]** buttons for 2 seconds or longer, the selected PTY is stored into that preset channel memory.

RDS Operations

Adjusting AF

The AF function switches to a different frequency on the same network in order to maintain optimum reception.

* The factory default setting is "ON".

1. Press the [TA] button for 1 second or longer and press [◀]/[▶] button to select "AF ON" or "AF OFF".
2. Turning the [ROTARY] knob clockwise to "AF ON"; turning it counterclockwise to "AF OFF".

* If the reception of the current broadcast station deteriorates, "SEARCH" appears in the display and the radio searches for the same programme on another frequency.

Adjusting REG

When the REG function is ON, the optimum regional station can be received. When this function is OFF, if the regional station area switches as you drive, a regional station for that region is received.

* The factory default setting is "OFF".

1. Press the [TA] button for 1 second or longer and press [◀]/[▶] button to select "REG ON" or "REG OFF".
2. Turning the [ROTARY] knob clockwise to "REG ON"; turning it counterclockwise to "REG OFF".

Emergency broadcast

If an emergency broadcast is received, all the function mode operations are stopped.

"ALARM" appears in the display and the emergency broadcast can be heard.

● Cancelling an emergency broadcast

If you press the [TA] button, emergency broadcast reception is cancelled.

Volume setting of TA, emergency broadcast (ALARM) and PTY

The volume for TA, ALARM and PTY interrupts can be set during TA, ALARM or PTY interrupt.

* The factory default setting is "15".

During a TA, ALARM or PTY interrupt, turn the [ROTARY] knob clockwise or counterclockwise to set the volume to the desired level (0 to 33).

* When the TA, ALARM or PTY interrupt ends, the volume returns to the level it had before the interrupt.

CD Mode Operations

Loading a CD

Insert a CD into the center of the CD insertion slot with the labeled side facing up. "LOADING" appears in the display, the CD enters into the slot and start playing.

Notes:

- Do not put your hand, fingers, or foreign objects into the CD insertion slot.
- If a CD has already been loaded, another CD cannot be inserted. Do not insert another one forcefully.
- Discs not bearing the  mark cannot be played with the unit. CD-ROMs cannot be played.
- Some CDs recorded in CD-R/CD-RW mode may not be usable.

Listening to the disc already inserted

Press the [SRC] button to select the CD mode, the CD will start playing.

Stopping (Pausing) playback

While the CD playing, pressing the [▶||] button will stop the CD and "PAUSE" indicate.

Press the [▶||] button again to resume playback.

Ejecting the CD

Press the [▲] button, then the CD will be ejected.

Note:

- If the ejected CD is left as it is, it will be reloaded after 15 seconds.

Top function

Press the [BND] button, then the CD will start playing from the first song (track number 1).

* For MP3 mode, it will start playing from the first song of current folder.

CD Mode Operations

Selecting tracks (Songs)

Press the [◀] or [▶] button.

- ▶ : Playback will start from the next track.
- ◀ : Playback will start from the beginning of the track currently playing. When this button is pressed again, the CD will play from the previous track.

* For MP3 mode, track selection is only valid in current folder.

Fast-forward and fast-backward

Press and hold the [◀◀] or [▶▶] button.

- ▶▶ : To fast-forward
- ◀◀ : To fast-backward

* For Audio CD mode pressing the [◀◀] or [▶▶] button for 1 second or longer will move forward or backward 5 times faster than normal play, and pressing it for 3 seconds or longer will do the operation 30 times faster.

* For MP3 mode, pressing the [◀◀] or [▶▶] button for 1 second or longer will move forward or backward 10 times faster than normal play.

Scan play (Intro Music Scan)

At Audio CD press the [SCN] button, the "SCN" is lit & display shows "TRK SCN", then the CD will play the first 10 seconds of each track of the whole disc. Press the [SCN] button again to disengage the unit from scan play.

* A scan play will start from the track following the one currently playing.

Repeat play

At Audio CD press the [RPT] button, the "RPT" is lit & display shows "TRK RPT", then the track currently playing will be played repeatedly. Press the [RPT] button again to disengage the unit from repeat play.

Random play

At Audio CD press the [RDM] button, the "RDM" is lit & display shows "TRK RDM", then the entire tracks on the disc will be played at random. Press the [RDM] button again to disengage the unit from random play.

MP3 Mode Operations

What is MP3?

MP3 is an audio compression method and classified into audio layer 3 of MPEG standards. This audio compression method has penetrated into PC users and become a standard format. This MP3 features the original audio data compression to about 12 percent of its initial size with a high quality sound. This means that about 10 music CDs can be recorded on a CD-R disc or CD-RW disc to allow a long listening time without having to change CDs.

Precautions when creating MP3 disc

● File extensions

- Always add a file extension ".MP3" to MP3 file by using single byte letters. If you add a file extension other than specified or forget to add the file extension, the file cannot be played.

● Logical format (File system)

- When writing MP3 file on a CD-R disc or CD-RW disc, please select "ISO9660 level 1, 2, 3 or JOLIET or Romeo" as the writing software format. normal play may not be possible if the disc is recorded on another format.
- The folder name and file name can be displayed as the title during MP3 play but the title must be within 16 (Folder Name) or 28 (File Name) single byte alphabetical letters and numerals (excluding an extension)

● Number of files or folders

- The MP3 recording media reproducible on this unit has the following limitations :
 1. Maximum number of files : 254
 2. Maximum number of folders : 128
 3. Some noise may occur depending on the type of encoder software used while recording.

Folder up down function

1. This function enables you to search for a folder on the MP3 CD. The LCD will show the target MP3 CD folder.

[UP] – Folder up

[DN] – Folder down

2. When a desired folder is selected, the MP3 CD player will play 1st track of target folder.

Note:

- The folder which contents of no MP3 file will be skipped.

MP3 Mode Operations

MP3 playing order

When selected for play folder up down functions, files and folders are accessed in the order in which they were written by the CD-ROM writer.

Because of this, the order in which they are expected to be played may not match the order in which they are actually played. You may be able to set the order in which MP3 are to be played by writing them onto a medium such as a CD-R with their file names beginning with play sequence numbers such as "01" to "99", depending on your CD writer.

For example, a medium with the following folder/file hierarchy is shown below.

Example of a medium's folder/file hierarchy

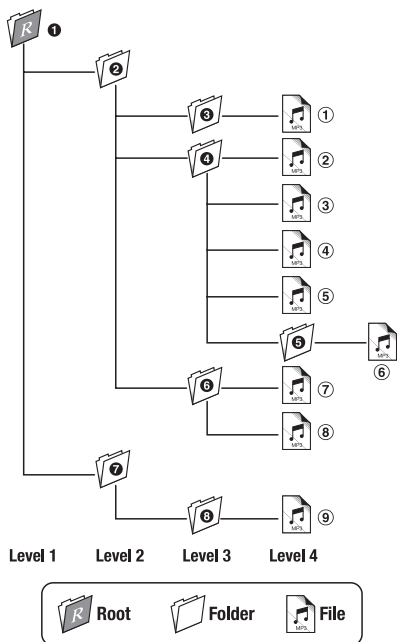

Random MP3 CD

1. This function enables you to play all the tracks in the MP3 folder or on the disc in random order.
2. There are 2 types of random play accessible for MP3 CDs; Random track and Random all folders.

Random access	Function	Display	Indicator
Press the [RDM] button less than 1 second	Random track in current folder only	"TRK RDM"	"RDM"
Press the [RDM] button more than 1 second	Random track in all folders	"FLDR RDM"	"ALL" & "RDM"

3. Each time the button is pressed, random play turns on or off.

Repeat MP3 CD

1. This function enables you to replay the track or folder you are listening to.
2. There are 2 types of repeat play accessible for MP3 CD; Repeat track and Repeat current folder.

Repeat access	Function	Display	Indicator
Press the [RPT] button less than 1 second	Repeat current song	"TRK RPT"	"RPT"
Press the [RPT] button more than 1 second	Repeat current folder	"FLDR RPT"	"ALL" & "RPT"

3. Each time the button is pressed, repeat play turns on or off.

Scan MP3 CD

1. This function enables you to play the first 10 seconds of each track in the MP3 folder or the first track of each folder.
2. There are 2 types of scan play accessible for MP3 CD; Scan track and Scan all folders.

MP3 Mode Operations

Repeat access	Function	Display	Indicator
Press the [SCN] button less than 1 second	Scan in current folder	"TRK SCN"	"SCN"
Press the [SCN] button more than 1 second	Scan first track of each folder	"FLDR SCN"	"ALL" & "SCN"

- Each time the button is pressed, scan play turns on or off.

Display selection

- You can choose the display type for MP3 CD by pressing the [D] button.

To select the next type, press the [D] button again.

The arrangement is shown below.

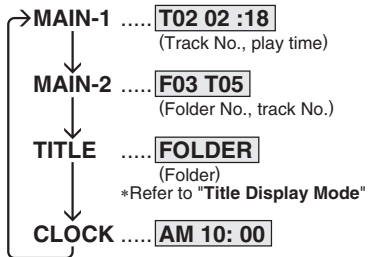

Title display mode

- There are 5 types of display for the Title Display mode.
- To select the next type, press the [T] button for less than 1 second.

The arrangement is shown below.

After 2 seconds

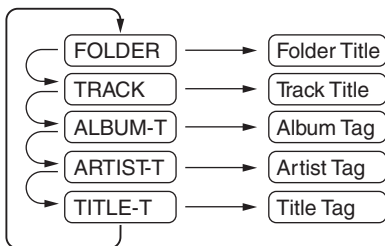

- The displayed item can be scrolled by pressing the [T] button for more than 1 second.
- If a MP3 file does not support for ID3 TAG, the display will show "NO TAG"
- If a MP3 file encode with ID3 TAG header but no consist of any TAG information, the display will show nothing.

Note:

- The folder name will be displayed as "ROOT" which the file allocates in the root folder.
- The MP3 player decodes each file ID3 TAG ver 2 by default, if ID3 TAG ver 2 is unavailable, ID3 TAG ver 1 will be decoded.
- UNICODE ID3 (Chinese, Japanese and etc) is not supported.

CD-DA/MP3 selection on Multi-Session CD

- If a multi-session CD which contains CD-DA and MP3 files is being inserted, user can select either CD-DA or MP3 files to be played.
- Default setting for files to be played on multi-session CD is CD-DA files.
- Press the [BND] button for more than 1 second will toggle between selection of CD-DA and MP3 files to be played.
- When CD-DA type is selected, display will show "M-S CD". When MP3 type is selected, display will show "M-S MP3".
- CD-DA/MP3 Selection function can only be performed in CD/MP3 mode. It will only activate after re-insert CD. For example, current setting is CD-DA type. Press [BND] button for more than 1 second to set MP3 type. User has to eject CD and re-insert it again as to play MP3 files.
- Types of recording that can be played are as follows.

Disc	Setting	Set to CD	Set to MP3
	Mixed with CD and MP3 type tracks		Play CD
CD type track only		Play CD	Play CD
MP3 type track only		Play MP3	Play MP3

- When a mixed mode CD is loaded and CD is set, the track to be played first is MP3 file data and no sound is heard.

7. IN CASE OF DIFFICULTY

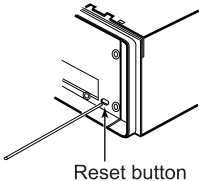
Problem	Cause	Solution
Power does not turn on. (No sound is produced)	Fuse is blown.	Replace with a fuse of the same amperage. If the fuse blows again, consult your store of purchase.
	Incorrect wiring.	Consult your store of purchase.
Compact disc cannot be loaded.	Another compact disc is already loaded.	Eject the compact disc before loading the new one.
Sound skips or is noisy.	Compact disc is dirty.	Clean the compact disc with a soft cloth.
	Compact disc is heavily scratched or warped.	Replace with a compact disc with no scratches.
Sound is bad directly after power is turned on.	Water droplets may form on the internal lens when the car is parked in a humid place.	Let dry for about 1 hour with the power on.
Nothing happens when button are pressed. Display is not accurate.	The microprocessor has malfunctioned due to noise, etc.	Turn off the power, then press the [RELEASE] button and remove the DCP. Press the reset button for about 2 seconds with a thin rod. 
	DCP or main unit connectors are dirty.	Wipe the dirt off with a soft cloth moistened with cleaning alcohol.

8. ERROR DISPLAYS

- To protect the system, this unit has been equipped with self diagnostic functions. If a fault arises, a warning is issued by various error displays. Follow the corrective measures and remove the fault.

Error Display	Corrective Measure
ERROR 2	This error display indicates that a fault has arisen in the mechanism of the source unit (for example, the disc cannot be ejected). → Check the source unit.
ERROR 3	This error display indicates that the pickup focus is off because of a scratched disc or some other factor during source unit play. → Check the compact disc.
ERROR 6	This indicates that the CD's TOC (table of contents) cannot be read, for example because the selected disc is upside-down.

9. SPECIFICATIONS

FM tuner

Frequency Range: 87.5 MHz to 108 MHz
 Usable Sensitivity: 11 dBf
 50 dB Quieting Sensitivity: 17 dBf
 Alternate Channel Selectivity: 75 dB
 Stereo Separation (1 kHz): 35 dB
 Frequency Response (± 3 dB): 30 Hz to 15 kHz

AM tuner

Frequency Range:
 MW 531 kHz to 1602 kHz
 LW 153 kHz to 279 kHz
 Usable Sensitivity: 25 μ V

CD player

System: Compact disc audio system
 Usable Discs: Compact disc
 Frequency Response: 10 Hz to 20 kHz (± 1 dB)
 Signal-to-Noise Ratio: 100 dB (1 kHz) IHF-A
 Dynamic Range: 95 dB (1 kHz)
 Harmonic Distortion: 0.01%

MP3

Decode Format: MPEG 1,2 and 2.5 -Layer 3
 Sampling rate (kHz): MPEG-1: 32,44,1,48
 MPEG-2: 16,22,05,24
 MPEG-2.5: 8,11,025,12
 Bit-rate (kbps): 8, 16, 24, 32, 40, 48, 56, 64, 80,
 96, 112, 128, 144, 160, 192,224
 256, 320, VBR
 CD-ROM Format: ISO9660 Level 1, 2, Romeo
 and Joliet
 Folder Level Limit: No limitation
 Folder Support: 128
 File Support: 254
 Folder Name: Maximum 16 characters
 File Name: Maximum 28 characters

Audio

Maximum Power Output: 204 W (51 W X 4 ch)
 Continuous Average Power Output:
 25 W X 4, into 4 Ω , 20 Hz to 20 kHz, 1%THD
 Bass Control Action (100 Hz): ± 14 dB
 Treble Control Action (10 kHz): ± 14 dB
 Line Output (with A/C 1 kHz, 10 k Ω): 1.8 V

General

Power Supply Voltage:
 14.4 V DC (10.8 V to 15.6 V allowable), negative ground
 Current Consumption: Less than 15 A
 Speaker Impedance: 4 Ω (4 Ω to 8 Ω allowable)
 Weight: 2.42 lb. (1.1 kg)
 Dimensions:
 178 mm Width X 50 mm Height X 152 mm Depth

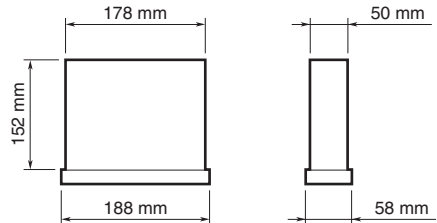

Notes:

- Specifications comply with JEITA Standards.
- Specifications and design are subject to change without notice for further improvement.
- Please make sure when connecting external power amplifier, that you properly, to the car chassis, ground the amplifier.
- If this is not done, severe damage to the source unit may happen.

Clarion Co., Ltd.

All Rights Reserved. Copyright © 2004: Clarion Co., Ltd.

Printed in Malaysia / Imprimé en Malaisie / Gedruckt in Malaysia / Stampato in Malaysia
Gedruckt in Maleisi / Impreso en Malasia / Tryckt i Malaysia / Impresso na Malásia

PE-2738E
280-8150-00

Free Manuals Download Website

<http://myh66.com>

<http://usermanuals.us>

<http://www.somanuals.com>

<http://www.4manuals.cc>

<http://www.manual-lib.com>

<http://www.404manual.com>

<http://www.luxmanual.com>

<http://aubethermostatmanual.com>

Golf course search by state

<http://golfingnear.com>

Email search by domain

<http://emailbydomain.com>

Auto manuals search

<http://auto.somanuals.com>

TV manuals search

<http://tv.somanuals.com>