

Clarion®

Owner's manual

使用说明书

사용 설명서

DXZ435

AM/FM CD PLAYER

AM/FM CD 播放器

AM/FM CD 플레이어

ProAudio **CaNET**

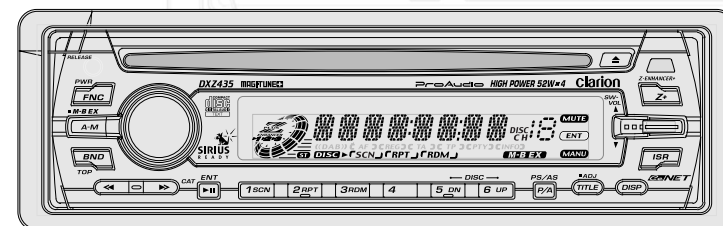

Clarion Co., Ltd.

All Rights Reserved. Copyright © 2003: Clarion Co., Ltd.

PE-2557K
280-7913-01

2003/04 (AB)



Thank you for purchasing this **Clarion** product.

- * Please read this owner's manual in its entirety before operating this equipment.
- * After reading this manual, be sure to keep it in a handy place (e.g., glove compartment).
- * Check the contents of the enclosed warranty card and keep it carefully with this manual.
- * This manual includes the operating procedures of the CD changer, MD changer and TV tuner connected via the CeNET cable. The CD changer, MD changer and TV tuner have their own manuals, but no explanations for operating them are described.

Contents

1. FEATURES	2
2. PRECAUTIONS	3
Handling Compact Discs	4
3. CONTROLS	5
4. NOMENCLATURE	6
Names of the Buttons and their Functions	6
Major button operations when external equipment is connected to this unit	6
Display Items	8
LCD Screen	8
5. DCP	9
6. REMOTE CONTROL	10
Inserting the Batteries	10
Functions of Remote Control Unit Buttons	11
7. OPERATIONS	12
Basic Operations	12
Radio Operations	14
CD Operations	16
Operations Common to Each Mode	17
8. OPERATIONS OF ACCESSORIES	20
CD/MD Changer Operations	20
TV Operations	22
9. IN CASE OF DIFFICULTY	24
10. ERROR DISPLAYS	25
11. SPECIFICATIONS	26

1. FEATURES

- 1-Bit D/A Converters and 8-Times Oversampling Digital Filter
- Z-ENHANCER PLUS for Sound Creation with 3 Adjustment Modes (2-Band P.EQ)
- MAGNA BASS EX for Dynamic Bass Tuning, Volume Level Dependent
- DIN Chassis with Detachable Control Aluminum Face with Blue Negative LC Display
- Screen Saver with User Programmable MESSAGE INFORMATION
- CeNET with Balanced Audio Line Transmission and Dynamic Noise Cancelling

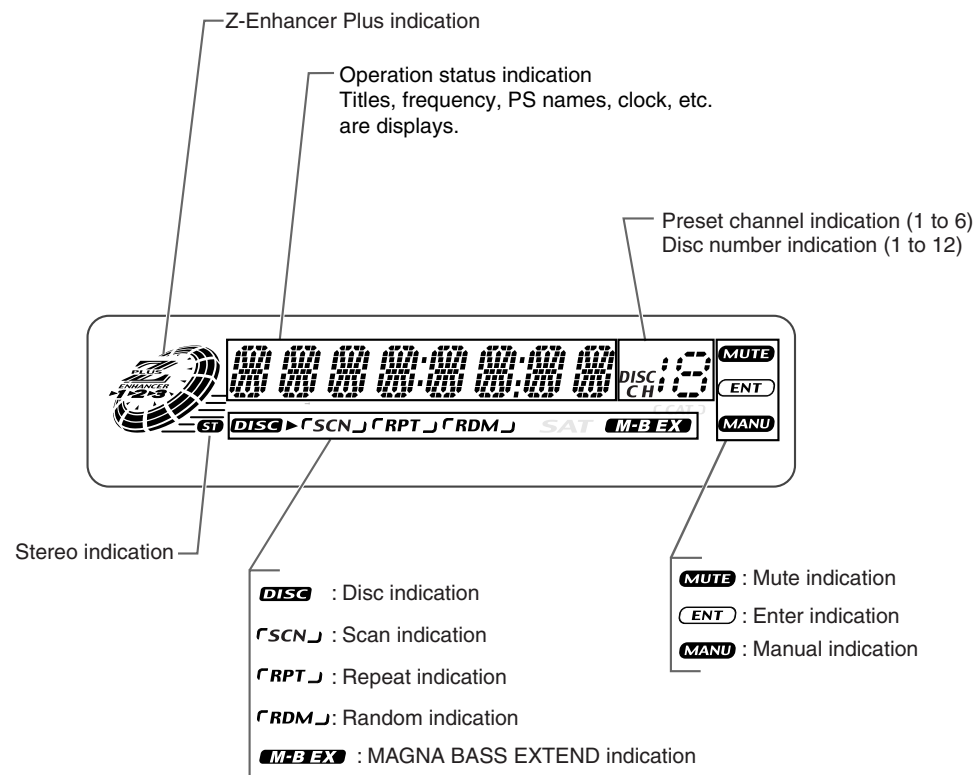

LCD Screen

In extreme cold, the screen movement may slow down and the screen may darken, but this is normal. The screen will recover when it returns to normal temperature.

2. PRECAUTIONS

1. When the inside of the car is very cold and the player is used soon after switching on the heater moisture may form on the disc or the optical parts of the player and proper playback may not be possible. If moisture forms on the disc, wipe it off with a soft cloth. If moisture forms on the optical parts of the player, do not use the player for about one hour. The condensation will disappear naturally allowing normal operation.
2. Driving on extremely bumpy roads which cause severe vibration may cause the sound to skip.
3. This unit uses a precision mechanism. Even in the event that trouble arises, never open the case, disassemble the unit, or lubricate the rotating parts.

CAUTION

USE OF CONTROLS, ADJUSTMENTS, OR PERFORMANCE OF PROCEDURES OTHER THAN THOSE SPECIFIED HEREIN, MAY RESULT IN HAZARDOUS RADIATION EXPOSURE.

THE COMPACT DISC PLAYER and MINI DISC PLAYER SHOULD NOT BE ADJUSTED OR REPAIRED BY ANYONE EXCEPT PROPERLY QUALIFIED SERVICE PERSONNEL.

CHANGES OR MODIFICATIONS NOT EXPRESSLY APPROVED BY THE MANUFACTURER FOR COMPLIANCE COULD VOID THE USER'S AUTHORITY TO OPERATE THE EQUIPMENT.

INFORMATION FOR USERS:

CHANGES OR MODIFICATIONS TO THIS PRODUCT NOT APPROVED BY THE MANUFACTURER WILL VOID THE WARRANTY AND WILL VIOLATE FCC APPROVAL.

Handling Compact Discs

Use only compact discs bearing the COMPACT DISC DIGITAL AUDIO mark.

Do not play heart-shaped, octagonal, or other specially shaped compact discs.

Some CDs recorded in CD-R/CD-RW mode may not be usable.

Handling

- Compared to ordinary music CDs, CD-R and CD-RW discs are both easily affected by high temperature and humidity and some of CD-R and CD-RW discs may not be played. Therefore, do not leave them for a long time in the car.
- New discs may have some roughness around the edges. If such discs are used, the player may not work or the sound may skip. Use a ball-point pen or the like to remove any roughness from the edge of the disc.
- Never stick labels on the surface of the compact disc or mark the surface with a pencil or pen.
- Never play a compact disc with any cellophane tape or other glue on it or with peeling off marks. If you try to play such a compact disc, you may not be able to get it back out of the CD player or it may damage the CD player.

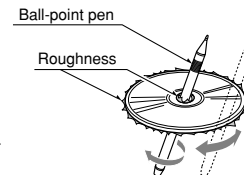

- Do not use compact discs that have large scratches, are misshapen, cracked, etc. Use of such discs may cause misoperation or damage.
- To remove a compact disc from its storage case, press down on the center of the case and lift the disc out, holding it carefully by the edges.
- Do not use commercially available CD protection sheets or discs equipped with stabilizers, etc. These may damage the disc or cause breakdown of the internal mechanism.

Storage

- Do not expose compact discs to direct sunlight or any heat source.
- Do not expose compact discs to excess humidity or dust.
- Do not expose compact discs to direct heat from heaters.

Cleaning

- To remove fingermarks and dust, use a soft cloth and wipe in a straight line from the center of the compact disc to the circumference.
- Do not use any solvents, such as commercially available cleaners, anti-static spray, or thinner to clean compact discs.
- After using special compact disc cleaner, let the compact disc dry off well before playing it.

3.CONTROLS / 控制 / 컨트롤

Source unit / 主机 / 본체

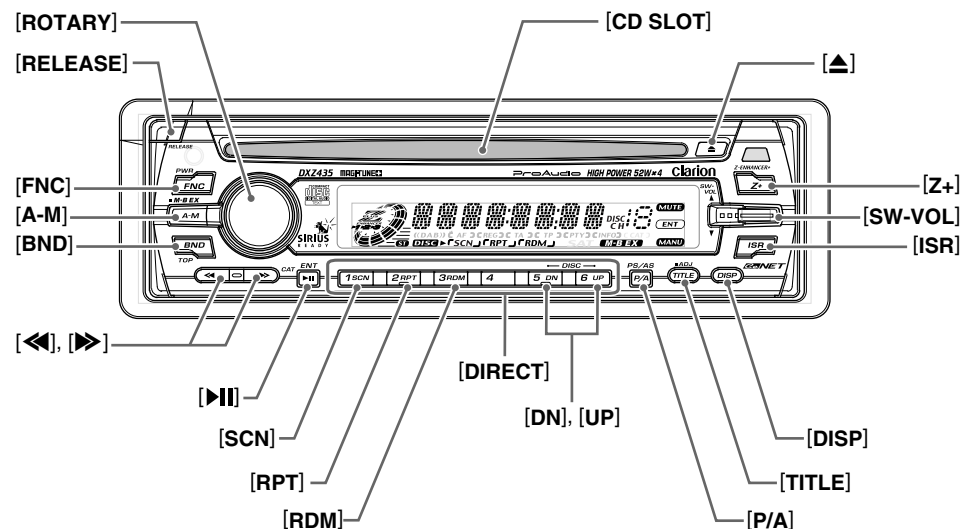

Note: Be sure to unfold this page and refer to the front diagrams as you read each chapter.

注意: 阅读各章时请务必参阅本页并参照前视图。

주: 이 페이지를 펼쳐두고, 각 장을 읽을 때 전면 그림을 참조하십시오.

4. NOMENCLATURE

Note:

• Be sure to read this chapter referring to the front diagrams of chapter "3. CONTROLS" on page 5 (unfold).

Names of the Buttons and their Functions

[RELEASE] button

- Press the [RELEASE] button to unlock the DCP.

[ROTARY] knob

- Adjust the volume by turning the knob clockwise or counterclockwise.
- Use the knob to perform various settings.

[CD SLOT]

- CD insertion slot.

[▲] button

- Eject a CD when it is loaded into the unit.

[Z+] button

- Use the button to select one of the 3 types of sound characteristics already stored in memory.

[SW-VOL] button

- Adjust sub woofer volume.
The volume is adjusted in the range ± 6 .

[ISR] button

- Recall ISR radio station in memory.
- Press and hold for 2 seconds or longer: Store current station into ISR memory (radio mode only).

[DISP] button

- Switch the display indication (Main display, Sub display, Clock display).

[TITLE] button

- Use the button to input a title in the CD mode.
- Press and hold the button for 1 second or longer to enter the adjust mode.

[P/A] button

- Perform preset scan while in the radio mode.
When the button is pressed and held, auto store is performed.

Major button operations when external equipment is connected to this unit

● When the CD/MD/DVD changer is connected

- * For details, see the section "CD/MD changer operations". For the DVD changer, refer to the Owner's Manual provided with the DVD changer.

[UP], [DN] buttons

- Select the disc.

[DIRECT] buttons

- Store a station into memory or recall it directly while in the radio mode.

[RDM] button

- Perform random play while in the CD mode.

[RPT] button

- Repeat play while in the CD mode.

[SCN] button

- Perform scan play for 10 seconds of each track while in the CD mode.

[▶||] button

- Play or pause a CD while in the CD mode.

[◀◀], [▶▶] buttons

- Select a station while in the radio mode or select a track when listening to a CD. These buttons are used to make various settings.
- Press and hold the button for 1 second or longer to switch the fast-forward/fast-backward.

[BND] button

- Switch the band, or seek tuning or manual tuning while in the radio mode.
- Play a first track while in the CD mode.

[A-M] button

- Use the button to switch to the audio mode (bass/treble, balance/fader Z-Enhancer Plus, Magna Bass Extended adjustment)

[FNC] button

- Press the button to turn on the power.
Press and hold the button for 1 second or longer to turn off the power.
- Switches the operation mode among the radio mode, etc.

[DISP] button

- When the button is pressed and held, switches the disc titles or track titles while in the MD changer mode.
- When the button is pressed and held, switches the user titles or track titles, etc. while in the CD changer mode.

[TITLE] button

- Use the button to input a title in the CD changer mode.
- Use the button to scroll the title during CD-text play or MD changer play in the MD changer mode.

[UP], [DN] buttons

- Select the disc.

[RDM] button

- Perform random play. Also perform disc random play when the button is pressed and held for 1 second or longer.

[RPT] button

- Perform repeat play. When this button is pressed and held for 1 second or longer, disc repeat play is performed.

[BND] button

- Move the next disc in increasing order.

[SCN] button

- Perform scan play for 10 seconds of each track. Disc scan play is performed when the button is pressed and held for 1 second or longer.

[▶||] button

- Play or pause a CD, MD or DVD.

[◀◀], [▶▶] buttons

- Select a track when listening to a disc.
- Press and hold the button for 1 second or longer to switch the fast-forward/fast-backward.

● When the TV is connected

- * For details, see the section "TV operations".

[P/A] button

- Perform preset scan while in the TV mode.
When the button is pressed and held for 2 seconds or longer, auto store is performed.

[▶||] button

- Switch the TV picture mode or VTR (external) picture mode.

[DIRECT] buttons

- Store a station into memory or recall it directly.

[◀◀], [▶▶] buttons

- Select a station.

[BND] button

- Switch the band.
- When the button is pressed and held for 1 second or longer, switch seek tuning or manual mode.

5. DCP

The control panel can be detached to prevent theft. When detaching the control panel, store it in the DCP (DETACHABLE CONTROL PANEL) case to prevent scratches.

We recommend taking the DCP with you when leaving the car.

Removing the DCP

1. Press the [FNC] button for 1 second or longer to switch off the power.
2. Press in the [RELEASE] button.

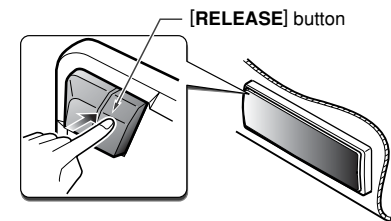

* The DCP is unlocked

3. Remove the DCP.

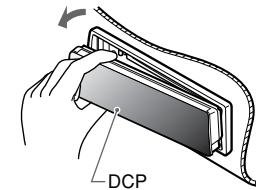

Attaching the DCP

1. Insert the right side of the DCP into the main unit.
2. Insert the left side of the DCP into the main unit.

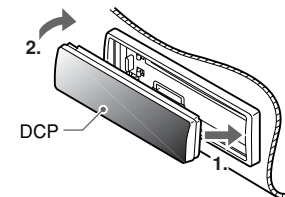

Storing the DCP in the DCP Case

Hold the DCP, in the orientation as shown in the figure below, and put it into the supplied DCP case. (Ensure the DCP is in the correct orientation.)

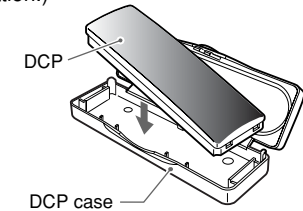

CAUTION

- The DCP can easily be damaged by shocks. After removing it, be careful not to drop it or subject it to strong shocks.
- When the Release button is pressed and the DCP is unlocked, the car's vibrations may cause it to fall. To prevent damage to the DCP, always store it in its case after detaching it. (see figure below.)
- The connector connecting the main unit and the DCP is an extremely important part. Be careful not to damage it by pressing on it with fingernails, screwdrivers, etc.

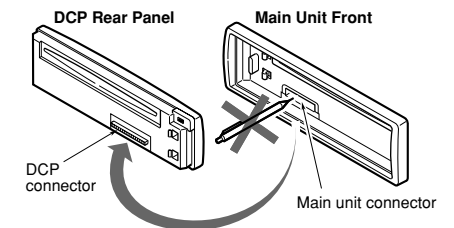

Note:

- If the DCP is dirty, wipe off the dirt with a soft, dry cloth only.

6. REMOTE CONTROL

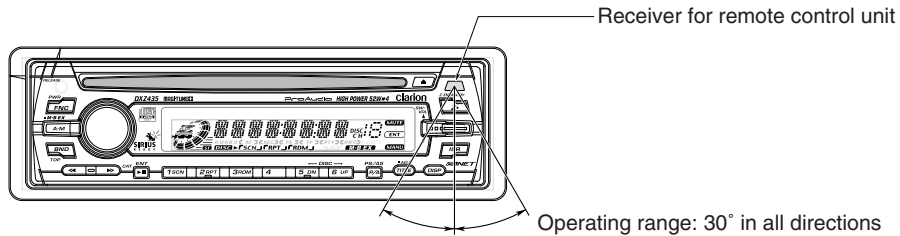

Remote control unit

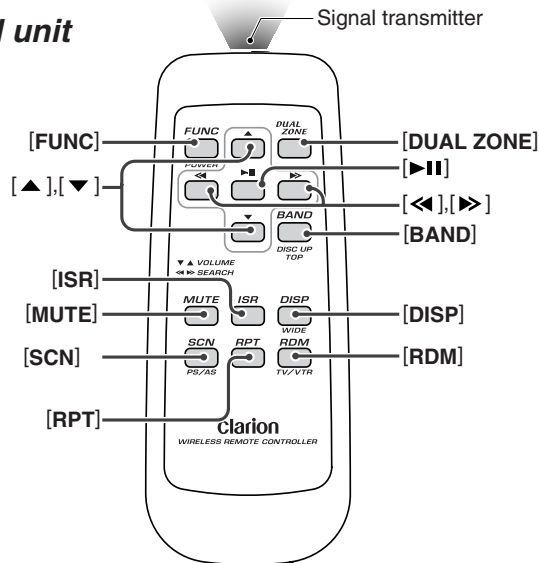

Inserting the Batteries

1. Turn the remote control unit over, then slide the rear cover in the direction of the arrow.
2. Insert the AA (SUM-3, IECR-6/1.5V) batteries that came with the remote control unit facing in the directions shown in the figure, then close the rear cover.

Notes:

Using batteries improperly can cause them to explode. Take note of the following points:

- When replacing batteries, replace both batteries with new ones.
- Do not short-circuit, disassemble or heat batteries.
- Do not dispose of batteries into fire or flames.
- Dispose of spent batteries properly.

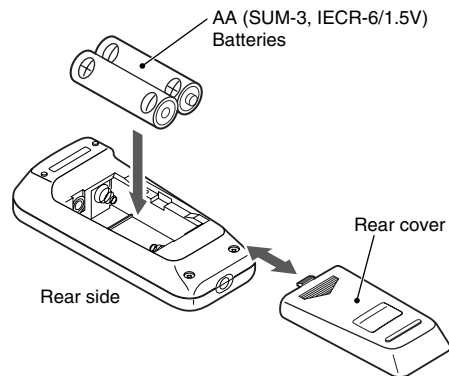

Functions of Remote Control Unit Buttons

Mode Button	Radio	CD	CD/MD changer DVD changer	TV
[FUNC]	Switches among radio, CD, CD/MD changer, DVD changer, TV and AUX.			
[BAND]	Switches reception band.	Plays the first track. Top play.	Moves the next disc in increasing order.	Switches reception band.
[▲], [▼]	Increases and decreases volume (in all modes).			
[<<], [>>]	Moves preset channels up and down.	Moves tracks up and down. When pressed and held for 1 second: Fast-forward/fast-backward.		Moves preset channels up and down.
[▶]	No function.	Switches between playback and pause.		No function.
[MUTE]	Turns mute on and off.			
[ISR]	Recalls ISR radio station in memory. Press and hold for 2 seconds or longer: Stores current station into ISR memory (radio mode only).			
[DISP]	Switches among main display, sub display, clock display.			
[SCN]	Preset scan. When pressed and held for 2 seconds: Auto store.	Scan play.	Scan play. When pressed and held for 1 second: Disc scan play.	Preset scan. When pressed and held for 2 seconds: Auto store.
[RPT]	No function.	Repeat play.	Repeat play. When pressed and held for 1 second: Disc repeat play.	No function.
[RDM]	No function.	Random play.	Random play. When pressed and held for 1 second: Disc random play.	Switches between TV and VTR.

* Some of the corresponding buttons on the main unit and remote control unit have different functions.

* [DUAL ZONE] button is not available.

7. OPERATIONS

Basic Operations

Note: Be sure to read this chapter referring to the front diagrams of chapter "3. CONTROLS" on page 5 (unfold).

CAUTION

Be sure to lower the volume before switching off the unit power or the ignition key. The unit remembers its last volume setting. If you switch the power off with the volume up, when you switch the power back on, the sudden loud volume may hurt your hearing and damage the unit.

Turning on/off the power

Note:

• Be careful about using this unit for a long time without running the engine. If you drain the car's battery too far, you may not be able to start the engine and this can reduce the service life of the battery.

1. Press the [FNC] button.
2. The illumination and display on the unit light up. The unit automatically remembers its last operation mode and will automatically switch to display that mode.
3. Press and hold the [FNC] button for 1 second or longer to turn off the power for the unit.

Note:

System check

The first time this unit is turned on after the wire connections are completed, it must be checked what equipment is connected. When the power is turned on, "SYSTEM" and "PUSH PWR" appear in the display alternately, so press the [FNC] button. The system check starts within the unit. When the system check is complete, press the [FNC] button again.

Selecting a mode

1. Press the [FNC] button to change the operation mode.
2. Each time you press the [FNC] button, the operation mode changes in the following order:
Radio mode → CD mode → CD changer mode → MD changer mode → DVD changer mode → TV mode → AUX mode → Radio mode...

* External equipment not connected with CeNET is not displayed.

Adjusting the volume

Turning the [ROTARY] knob clockwise increases the volume; turning it counterclockwise decreases the volume.

* The volume level is from 0 (minimum) to 33 (maximum).

Switching the display

Press the [DISP] button to select the desired display.

Each time you press the [DISP] button, the display switches in the following order:

Main display



Sub display



Clock display



Main display

* Once selected, the preferred display becomes the display default. When a function adjustment such as volume is made, the screen will momentarily switch to that function's display, then revert back to the preferred display several seconds after the adjustment.

* When you have entered a title in a CD, it appears in the sub display. If you have not entered a title, "NO TITLE" appears in the title display instead. For information on how to enter a title, refer to the subsection "Entering titles" in section "Operations Common to Each Mode".

Setting the Z-Enhancer Plus

This unit are provided with 3 types of sound tone effects stored in memory. Select the one you prefer.

* The factory default setting is "Z+ OFF".

Each time you press the [Z+] button, the tone effect changes in the following order:

Basic Operations

"Z+ OFF" → "B-BOOST" → "IMPACT" → "EXCITE" → "CUSTOM" → "Z+ OFF" ...

- B-BOOST : bass emphasized
- IMPACT : bass and treble emphasized
- EXCITE : bass and treble emphasized mid-de-emphasized
- CUSTOM : user custom
- Z+ OFF : no sound effect

Adjusting the tone

Press the [A-M] button and select the item to adjust. Each time you press the [A-M] button, the item changes as following order:

●When "B-BOOST" is set

"B-BOOST" → "BAL 0" → "FAD 0" → Last function mode.

●When "IMPACT" is set

"IMPACT" → "BAL 0" → "FAD 0" → Last function mode.

●When "EXCITE" is set

"EXCITE" → "BAL 0" → "FAD 0" → Last function mode.

●When "CUSTOM" is set

"BASS" → "TREBLE" → "BAL 0" → "FAD 0" → Last function mode.

●When "Z+ OFF" is set

"BAL 0" → "FAD 0" → Last function mode.

Adjusting the bass (Gain, Frequency, Q-curve)

This adjustment can be performed when the Z-Enhancer Plus is set to "CUSTOM".

1. Press the [A-M] button and select "BASS".
2. Turning the [ROTARY] knob clockwise emphasizes the bass; turning it counterclockwise attenuates the bass.
* The factory default setting is "B<G 0>". (Adjustment range: -6 to +6)
3. Press the [▶▶] or [◀◀] button to select "B<F 60>".
Turning the [ROTARY] knob clockwise or counterclockwise to select the frequency.
* The factory default setting is "B<F 60>". (Adjustment range: 60/100/200 Hz)
4. Press the [▶▶] or [◀◀] button to select "B<Q 1>".
Turning the [ROTARY] knob clockwise or counterclockwise to select the Q-curve.

* The factory default setting is "B<Q 1>". (Adjustment 1/1.25/1.5/2)

5. When the adjustment is complete, press the [A-M] button several times until the function mode is reached.

Adjusting the treble (Gain, Frequency)

This adjustment can be performed when the Z-Enhancer Plus is set to "CUSTOM".

1. Press the [A-M] button and select "TREBLE".
2. Turning the [ROTARY] knob clockwise emphasizes the treble; turning it counterclockwise attenuates the treble.
* The factory default setting is "T<G 0>". (Adjustment range: -6 to +6)
3. Press the [▶▶] or [◀◀] button to select "T<F 10>".
Turning the [ROTARY] knob clockwise or counterclockwise to select the frequency.
* The factory default setting is "T<F 10>". (Adjustment 10 kHz/15 kHz)
4. When the adjustment is complete, press the [A-M] button several times until the function mode is reached.

Adjusting the balance

1. Press the [A-M] button and select "BAL 0".
2. Turning the [ROTARY] knob clockwise emphasizes the sound from the right speaker; turning it counterclockwise emphasizes the sound from the left speaker.
* The factory default setting is "BAL 0". (Adjustment range: L13 to R13)
3. When the adjustment is complete, press the [A-M] button several times until the function mode is reached.

Adjusting the fader

1. Press the [A-M] button and select "FAD 0".
2. Turning the [ROTARY] knob clockwise emphasizes the sound from the front speakers; turning it counterclockwise emphasizes the sound from the rear speakers.
* The factory default setting is "FAD 0". (Adjustment range: F12 to R12)
3. When the adjustment is complete, press the [A-M] button several times until the function mode is reached.

Basic Operations

Adjusting the Z-Enhancer Plus

- Press the **[Z+]** button and select the Z-Enhancer Plus mode to adjust.
 - Press the **[A-M]** button and turning the **[ROTARY]** knob clockwise adjusts in the + direction; turning it counterclockwise adjusts in the – direction.
 - When “**B-BST 0**” is selected, you can adjust the bass in the range of –3 to 3.
 - When “**IMPACT 0**” is selected, you can adjust the bass and treble in the range of –3 to 3.
 - When “**EXCITE 0**” is selected, you can adjust the bass and treble in the range of –3 to 3.
- * Press and hold the **[Z+]** button for 2 seconds or longer to change to the “**CUSTOM**” mode. Bass/treble characteristics become flat and the indication “**Z+FLAT**” is shown in the display.
- Press the **[Z+]** button again to change to the “**Z+ OFF**” mode.

Adjusting MAGNA BASS EXTEND

The MAGNA BASS EXTEND does not adjust the low sound area like the normal sound adjustment function, but emphasizes the deep bass sound area to provide you with a dynamic sound.

* The factory default setting is off.

- Press and hold the **[A-M]** button for 1 second or longer to turn on the MAGNA BASS EXTEND effect. “**M-B EX**” lights in the display.
- Press and hold the **[A-M]** button for 1 second or longer to turn off the MAGNA BASS EXTEND effect. “**M-B EX**” goes off from the display.

Adjusting the subwoofer

When you default select one of mode (LPF50, LPF80, LPF120).

* The factory default setting is “**S-VOL 0**”. (Adjustment range: –6 to +6)

- Press the **[SW-VOL ↕]** button to select the subwoofer volume increases or decreases.
- Press and hold the **[SW-VOL ↕]** button, the subwoofer volume automatically increases or decreases.

Radio Operations

FM reception

For enhanced FM performance the **MAGTUNE**® tuner includes signal actuated stereo control, Enhanced Multi AGC, Impulse noise reduction circuits and Multipath noise reduction circuits.

Listening to the radio

- Press the **[FNC]** button and select the radio mode. The frequency or PS appears in the display.
 - * PS: Programme service name
- Press the **[BND]** button and select the radio band. Each time the button is pressed, the radio reception band changes in the following order:
FM1 → FM2 → FM3 → AM → FM1...
- Press the **[◀]** or **[▶]** button to tune in the desired station.

Tuning

There are 3 types of tuning mode available, seek tuning, manual tuning and preset tuning.

Seek tuning

- Press the **[BND]** button and select the desired band (FM or AM).
 - * If “**MANU**” is lit in the display, press and hold the **[BND]** button for 1 second or longer. “**MANU**” in the display goes off and seek tuning is now available.
- Press the **[◀]** or **[▶]** button to automatically seek a station.

When the **[▶]** button is pressed, the station is sought in the direction of higher frequencies; if the **[◀]** button is pressed, the station is sought in the direction of lower frequencies.

Radio Operations

Manual tuning

There are 2 ways available: Quick tuning and step tuning.

When you are in the step tuning mode, the frequency changes one step at a time. In the quick tuning mode, you can quickly tune the desired frequency.

- Press the **[BND]** button and select the desired band (FM or AM).
 - * If “**MANU**” is not lit in the display, press and hold the **[BND]** button for 1 second or longer. “**MANU**” is lit in the display and manual tuning is now available.
- Tune in a station.

● Quick tuning:

Press and hold the **[◀◀]** or **[▶▶]** button for 1 second or longer to tune in a station.

● Step tuning:

Press the **[◀]** or **[▶]** button to manually tune in a station.

Recalling a preset station

A total of 24 preset positions (6-FM1, 6-FM2, 6-FM3, 6-AM) exist to store individual radio stations in memory. Pressing the corresponding **[DIRECT]** button recalls the stored radio frequency automatically.

- Press the **[BND]** button and select the desired band (FM or AM).
- Press the corresponding **[DIRECT]** button to recall the stored station.
 - * Press and hold one of the **[DIRECT]** buttons for 2 seconds or longer to store that station into preset memory.

Manual memory

- Select the desired station with seek tuning, manual tuning or preset tuning.
- Press and hold one of the **[DIRECT]** buttons for 2 seconds or longer to store the current station into preset memory.

Auto store

Auto store is a function for storing up to 6 stations that are automatically tuned in sequentially. If 6 receivable stations cannot be received, a previously stored station remains unoverwritten at the memory position.

- Press the **[BND]** button and select the desired band (FM or AM).
- Press and hold the **[P/A]** button for 2 seconds or longer. The stations with good reception are stored automatically to the preset channels.
 - * If auto store is performed in the FM bands, the stations are stored in FM3 even if FM1 or FM2 was chosen for storing stations.

Preset scan

Preset scan receives the stations stored in preset memory in order. This function is useful when searching for a desired station in memory.

- Press the **[P/A]** button.
- When a desired station is tuned in, press the **[P/A]** button again to continue receiving that station.

Note:

- Be careful not to press and hold the **[P/A]** button for 2 seconds or longer, otherwise the auto store function is engaged and the unit starts storing stations.

Instant station recall (ISR)

Instant station recall is a special radio preset that instantly accesses a favorite radio station at a touch of a button. The ISR function even operates with the unit in other modes.

● ISR memory

- Select the station that you wish to store in ISR memory.
- Press and hold the **[ISR]** button for 2 seconds or longer.

● Recalling a station with ISR



In any mode, press the **[ISR]** button to turn on the radio function and tune the selected radio station. “**ISR**” appears in the display. Press the **[ISR]** button again to return to the previous mode.

Loading a CD

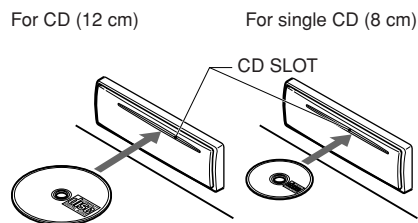
Insert a CD into the centre of the CD SLOT with the labeled side facing up. "LOADING" appears in the display, the CD enters into the slot, and the play starts.



Notes:

- Never insert foreign objects into the CD SLOT.
- If the CD is not inserted easily, there may be another CD in the mechanism or the unit may require service.
- Discs not bearing the  or  mark and CD-ROMs cannot be played by this unit.
- Some CDs recorded in CD-R/CD-RW mode may not be usable.

Loading 8 cm compact discs

- * No adapter is required to play an 8 cm CD.
- * Insert the 8 cm CD into the centre of the insertion slot.

Listening to a CD already inserted

Press the [FNC] button to select the CD mode. Play starts automatically. If no CD is loaded in the unit, "NO DISC" appears in the display.

Pausing play

1. Press the [▶||] button to pause play. "PAUSE" appears in the display.
2. To resume CD play, press the [▶||] button again.

Displaying CD titles

This unit can display title data for CD-text CDs and user titles input with this unit.

1. Press the [DISP] button to display the title.
2. Each time you press and hold the [DISP] button for 1 second or longer, the title display changes in the following order:
User title (disc) → CD-text title (disc) → Artist name → CD-text title (track) → User title (disc)...

Note:

- If the CD playing is not a CD-text CD or no user title has been input, "NO TITLE" appears in the display.

Ejecting a CD

1. Press the [▲] to eject the CD. Take it out from the ejected position.

Note:

- If you force a CD into before auto reloading, this can damage the CD.
- * If a CD (12 cm) is left in the ejected position for 15 seconds, the CD is automatically reloaded (Auto reload).
- * 8 cm CDs are not auto reloaded. Be sure to remove it when ejected.

Selecting a track

●Track-up

1. Press the [▶▶] button to move ahead to the beginning of the next track.
2. Each time you press the [▶▶] button, the track advances ahead to the beginning of the next track.

●Track-down

1. Press the [◀◀] button to move back to the beginning of the current track.
2. Press the [◀◀] button twice to move to the beginning of the previous track.

Fast-forward/fast-backward

●Fast-forward

Press and hold the [▶▶] button for 1 second or longer.

●Fast-backward

Press and hold the [◀◀] button for 1 second or longer.

Top function

The top function resets the CD player to the first track of the disc. Press the [BND] button to play the first track (track No. 1) on the disc.

Scan play

The scan play locates and plays the first 10 seconds of each track on a disc automatically. This function continues on the disc until it is cancelled.

- * The scan play is useful when you want to select a desired track.

1. Press the [SCN] button to start scan play. "SCN" lights in the display.
2. To cancel the scan play, press the [SCN] button again. "SCN" goes off from the display and the current track continues to play.

Repeat play

The repeat play continuously plays the current track. This function continues automatically until it is cancelled.

1. Press the [RPT] button. "RPT" lights in the display and the current track is repeated.
2. To cancel the repeat play, press the [RPT] button again. "RPT" goes off from the display and normal play resumes.

Random play

The random play selects and plays individual tracks on a disc in no particular order. This function continues automatically until it is cancelled.

1. Press the [RDM] button. "RDM" lights in the display, an individual track is selected randomly and play begins.
2. To cancel the random play, press the [RDM] button again. "RDM" goes off from the display and normal play resumes.

Turning the screen saver function on or off

This unit is provided with the screen saver function which allows you to show various kinds of patterns and characters in the Operation Status indication area of the display in a random order. You can turn on and off this function.

If the button operation is performed with the screen saver function on, the operation display corresponding to the button operation is shown for about 30 seconds and the display returns to the screen saver display.

- * The factory default setting is "SS".

1. Press and hold the [TITLE] button for 1 second or longer to switch to the adjustment selection display.
2. Press the [◀◀] or [▶▶] button to select "SCRN SVR".
3. Press the [▶||] button.
4. Turn the [ROTARY] knob clockwise or counterclockwise to select the setting. Each time you turn the [ROTARY] knob, the setting changes in the following order:
OFF → SS → MESSAGE
5. Press the [▶||] button to store the setting.
6. Press the [TITLE] button to return to the previous mode.

- * The following illustration presents one of the patterns which are shown when the screen saver function is turned on.



Entering MESSAGE INFORMATION

Message up to 30 characters long can be stored in memory and displayed for any mode.

- * The factory default setting is "WELCOME TO CLARION".

1. Press and hold the [TITLE] button for 1 second or longer to switch to the adjustment selection display.
2. Press the [◀◀] or [▶▶] button to select "INPUT".
3. Press the [▶||] button.
4. Press the [◀◀] or [▶▶] button to move the cursor.

Operations Common to Each Mode

- Press the [DISP] button to select a character. Each time you press the [DISP] button, the character changes in the following orders: Numbers → Symbols → Capital letters → Numbers...
- Turn the [ROTARY] knob to select the desired character.
- Repeat step 4 to 6 to enter up to 30 characters for message.
- Press and hold the [▶||] button for 2 seconds or longer to store the message in memory and cancel input message.
- Press the [TITLE] button to return to the previous mode.

Setting the method for title scroll

Set how to scroll in CD-TEXT or MD.

* The factory default setting is "ON".

- Press and hold the [TITLE] button for 1 second or longer to switch to the adjustment selection display.
- Press the [◀] or [▶] button to select "SCROLL".
- Turn the [ROTARY] knob clockwise or counterclockwise and select "ON" or "OFF".
 - **ON:**
To scroll automatically.
 - **OFF:**
To scroll just 1 time when the title was changed or the title key was pressed.
- Press the [TITLE] button to return to the previous mode.

Dimmer control

You can set the dimmer control on or off.

* The factory default setting is "ON".

- Press and hold the [TITLE] button for 1 second or longer to switch to the adjustment selection display.
- Press the [◀] or [▶] button to select "DIMMER".
- Turn the [ROTARY] knob clockwise to "ON" or counterclockwise to "OFF".
- Press the [TITLE] button to return to the previous mode.

Adjusting the display contrast

You can adjust the display contrast to match the angle of installation of the unit.

* The factory default setting is "5". (Adjustment level:1 to 8)

- Press and hold the [TITLE] button for 1 second or longer to switch to the adjustment selection display.
- Press the [◀] or [▶] button to select "CONTRAST".
- Turn the [ROTARY] knob clockwise or counterclockwise to adjust the contrast.
- Press the [TITLE] button to return to the previous mode.

Setting LOW PASS FILTER

This function allows you to set the low-pass filter sub-woofer output.

* The factory default setting is "LPF 120".

- Press and hold the [TITLE] button for 1 second or longer to switch to the adjustment selection display.
- Press the [◀] or [▶] button to select "SW LPF".
- Turn the [ROTARY] knob clockwise or counterclockwise to select the setting. Each time you turn the [ROTARY] knob, the setting changes in the following order:
REAR → LPF 50 → LPF 80 → LPF 120
- Press the [TITLE] button to return to the previous mode.

Selecting AUX IN sensitivity

Make the following settings to select the sensitivity when sounds from external devices connected to this unit are difficult to hear even after adjusting the volume.

* The factory default setting is "MID".

- Press and hold the [TITLE] button for 1 second or longer to switch to the adjustment selection display.
- Press the [◀] or [▶] button to select "AUX SENS".
- Turn the [ROTARY] knob clockwise or counterclockwise as needed and select from "HIGH", "MID" or "LOW".
- Press the [TITLE] button to return to the previous mode.

Operations Common to Each Mode

Setting the clock

- Press and hold the [TITLE] button for 1 second or longer to switch to the adjustment selection display.
- Press the [◀] or [▶] button to select "CLOCK".
- Press the [▶||] button.
- Press the [◀] or [▶] button to select the hour or the minute.
- Turn the [ROTARY] knob clockwise or counterclockwise to set the correct time.
 - * The clock is displayed in 12-hour format.
- Press the [▶||] button to store the time into memory.
- Press the [TITLE] button to return to the previous mode.

Note:

• You cannot set the clock when it is displayed with only the ignition on. If you drain or remove the car's battery or take out this unit, the clock is reset. While setting the clock, if another button or operation is selected, the clock set mode is canceled.

Entering titles

Titles up to 8 characters long can be stored in memory and displayed for CD, CD changer and TV stations. The number of titles that can be entered for each mode are as follows.

Mode	Number of titles
CD mode	50 titles
TV mode	20 titles

CD changer mode	Number of titles
DCZ625 connected	100 titles
CDC655Tz connected	100 titles
CDC1255z connected	50 titles

- Press the [FNC] button to select the mode you want to enter a title (CD, CD changer or TV).
- Select and play a CD in the CD changer or tune in to a TV station for which you want to enter the title.
- Press the [DISP] button and display the sub.
- Press the [TITLE] button. The cursor position flashes.
- Press the [◀] or [▶] button to move the cursor.

- Press the [DISP] button to select a character. Each time you press the [DISP] button, the character changes in the following order: Numbers → Symbols → Capital letters → Numbers...
- Turn the [ROTARY] knob to select the desired character.
- Repeat steps 5 to 7 to enter up to 8 characters for the title.
- Press and hold the [▶||] button for 2 seconds or longer to store the title into memory and cancel title input mode.

Clearing titles

- Select and play a CD in the CD changer or tune in to a TV station for which you want to clear the title.
- Press the [DISP] button and display the sub.
- Press the [TITLE] button. The display switches to the title input display.
- Press the [BND] button.
- Press and hold the [▶||] button for 2 seconds or longer to clear the title and cancel title input mode.

AUX function

This system has an external input jack so you can listen to sounds and music from external devices connected to this unit.

8. OPERATIONS OF ACCESSORIES

CD/MD Changer Operations

CD/MD changer functions

When an optional CD/MD changer is connected through the CēNET cable, this unit controls all CD/MD changer functions. This unit can control a total of 2 changers.

Press the [FNC] button and select the CD(MD) changer mode to start play. If 2 CD(MD) changers are connected, press the [FNC] button to select the CD(MD) changer for play.

* If "NO MAG" appears in the display, insert the magazine into the CD changer. "DISC CHK" appears in the display while the player loads (checks) the magazine.

* If "NO DISC" appears in the display, eject the magazine and insert discs into each slot. Then, reinsert the magazine back into the CD changer.

* If "NO DISC" appears in the display, load MDs into the MD changer.

Note:

- Some CDs recorded in CD-R/CD-RW mode may not be usable.

CAUTION

CD-ROM discs cannot be played from every CD changer, it's depended on the model.

Pausing play

1. Press the [▶||] button to pause play. "PAUSE" appears in the display.
2. To resume play, press the [▶||] button again.

Displaying CD titles

This unit can display title data for CD-text CDs and user titles input with this unit.

* Title data for CD-text CDs can be displayed with this unit only when it is connected to CDC655Tz.

●When connected to CDC655z or CDC1255z.

Press the [DISP] button to display the title.

●When connected to DCZ625 or CDC655Tz

1. Press the [DISP] button to display the title.
2. Each time you press and hold the [DISP] button for 1 second or longer, the title display changes in the following order:

User title (disc) → CD-text title (disc) → Artist title → CD-text title (track) → User title (disc)...

Notes:

- If the CD playing is not a CD-text CD or no user title has been input, "NO TITLE" appears in the display.
- If a CD-text CD is not input its disc title or a track title, "NO TITLE" appears in the display.

Switching disc titles and track titles (MD)

This unit can display disc titles and track titles already entered on MDs.

* Titles cannot be entered for MDs with this unit.

1. Press [DISP] button to display the title. The disc title or track title is displayed.
2. Each time you press and hold the [DISP] button for 1 second or longer, the display toggles between the disc title and the track title.

Note:

- If an MD is not input its disc title or a track title, "NO TITLE" appears in the display.

Procedure to scroll a title

Set "SCROLL" to "ON" or "OFF".

(The factory default setting is "ON". Refer to the subsection "Turning the screen saver function on or off" in section "Operation common to each mode".)

●When set to "ON"

The title is automatically kept scrolling.

●When set to "OFF"

Press the [TITLE] button to scroll the title.

Selecting a CD

[DN] or [UP] button correspond to a disc load in the magazine.

Press the [DN] or [UP] button to select the desired disc.

* If a CD is not loaded in a slot of magazine, "NO DISC" appears in the display.

CD/MD Changer Operations

Selecting a MD

[DN] or [UP] button correspond to a MD load in the MD changer. Press the [DN] or [UP] button to select the desired disc.

* If a MD is not loaded in a slot of MD changer, "NO DISC" appears in the display.

Selecting a track

●Track-up

1. Press the [▶▶] button to move ahead to the beginning of the next track.
2. Each time you press the [▶▶] button, the track advances ahead to the beginning of the next track.

●Track-down

1. Press the [◀◀] button to move back to the beginning of the current track.
2. Press the [◀◀] button twice to move to the beginning of the previous track.

Fast-forward/fast-backward

●Fast-forward

Press and hold the [▶▶] button for 1 second or longer.

●Fast-backward

Press and hold the [◀◀] button for 1 second or longer.

Scan play

Scan play locates and plays the first 10 seconds of each track on a disc automatically. This function continues on the disc until it is cancelled.

* The scan play is useful when you want to select a desired track.

1. Press the [SCN] button to start track scanning. "SCN" lights in the display.
2. To cancel the scan play, press the [SCN] button again. "SCN" goes off from the display and the current track continues to play.

Disc scan play

Disc scan play locates and plays the first 10 seconds of the first track on each disc in the currently selected CD (MD) changer. This function continues automatically until it is cancelled.

* Disc scan play is useful when you want to select a desired CD (MD).

1. Press and hold the [SCN] button for 1 second or longer. "DISC" and "SCN" light in the display and disc scan play starts.

2. To cancel disc scan play, press the [SCN] button again. "DISC" and "SCN" go off from the display and the current track continues to play.

Repeat play

Repeat play continuously plays the current track. This function continues automatically until it is cancelled.

1. Press the [RPT] button. "RPT" lights in the display and the current track is repeated.
2. To cancel repeat play, press the [RPT] button again. "RPT" goes off from the display and normal play resumes.

Disc repeat play

After all the tracks on the current disc have been played, disc repeat play automatically replays the current disc over from the first track. This function continues automatically until it is cancelled.

1. Press and hold the [RPT] button for 1 second or longer. "DISC" and "RPT" light in the display and disc repeat play starts.
2. To cancel disc repeat play, press and hold the [RPT] button again. "DISC" and "RPT" go off from the display and normal play resumes on the current track.

Random play

Random play selects and plays individual tracks on the disc in no particular order. This function continues automatically until it is cancelled.

1. Press the [RDM] button. "RDM" lights in the display and random play begins.
2. To cancel random play, press the [RDM] button again. "RDM" goes off from the display and normal play resumes.

Disc random play

The disc random play selects and plays individual tracks or discs automatically in no particular order. This function continues automatically until it is cancelled.

1. Press and hold the [RDM] button for 1 second or longer. "DISC" and "RDM" light in the display and disc random play starts.
2. To cancel disc random play, press and hold the [RDM] button again. "DISC" and "RDM" go off from the display and normal play resumes from the current track.

TV tuner functions

When an optional TV tuner is connected through the CeNET cable, this unit controls all TV tuner functions. To watch TV requires a TV tuner and monitor.

Watching a TV

1. Press the [FNC] button and select the TV mode.
2. Press the [BND] button to select the desired TV band (TV1 or TV2). Each time the button is pressed, the input selection toggles between TV1 and TV2.
3. Press the [◀] or [▶] button to tune in the desired TV station.

Watching a video

The TV tuner has a VTR input terminal to which 1 external device can be connected. Connect a 12 V video cassette player (VCP) or video cassette recorder (VCR) to the TV tuner input terminal.

1. Press the [▶II] button to select VTR.
2. To return to the TV broadcast, press the [▶II] button.

Tuning

There are 3 types of tuning mode available, Seek tuning, manual tuning and preset tuning.

Seek tuning

1. Press the [BND] button and select the desired TV band (TV1 or TV2).
 - * If "MANU" is lit in the display, press and hold the [BND] button for 1 second or longer. "MANU" in the display goes off and seek tuning is now available.
2. Press the [◀] or [▶] button to automatically seek a station. Press the [▶] button to automatically tune up the frequency band to the next available TV station; press the [◀] button to automatically tune down.

Manual tuning

There are 2 ways available: Quick tuning and step tuning.

When you are in the step tuning mode, the frequency changes one step at a time. In the quick tuning mode, you can quickly tune the desired frequency.

1. Press the [BND] button and select the desired band (TV1 or TV2).
 - * If "MANU" is not lit in the display, press and hold the [BND] button for 1 second or longer. "MANU" lights in the display and manual tuning is now available.
2. Tune in a station.

● Quick tuning:

Press and hold the [◀] or [▶] button for 1 second or longer to tune in a station.

● Step tuning:

Press the [◀] or [▶] button to manually tune in a station.

Recalling a preset station

A total of 12 TV stations can be stored (6-TV1 and 6-TV2). This allows you to select your favorite TV stations and store them in memory for later recall.

1. Press the [BND] button and select the desired TV band (TV1 or TV2).
2. To recall a stored TV station, press the desired [DIRECT] button to select that station.
 - * Press and hold one of the [DIRECT] buttons for 2 seconds or longer to store the current station into preset memory.

Manual memory

1. Select the desired station with seek tuning, manual tuning or preset tuning.
2. Press and hold one of [DIRECT] buttons for 2 seconds or longer to store the current station into preset memory.

Auto store

Auto store selects 6 TV stations automatically and stores each one into preset memory.

If there are not 6 stations with good reception, stations previously stored in memory remain and only the strong stations are stored into memory.

1. Press the [BND] button and select the desired TV band (TV1 or TV2).
2. Press and hold the [P/A] button for 2 seconds or longer. The stations with good reception are stored automatically to the preset channels.

Preset scan

Preset scan allows the user to view each preset position before it automatically advances to the next preset. This function is useful for searching for a desired TV station in memory.

1. Press the [P/A] button.
2. When the desired station is found, press the [P/A] button again to remain tuned to that station.

Note:

- Do not press and hold the [P/A] button for 2 seconds or longer. Doing so will trigger the auto store function and start storing stations into memory.

Setting the TV diver

You can change the reception setting for the TV antenna connected to the TV tuner.

1. Press and hold the [TITLE] button for 1 second or longer to switch to the adjustment selection display.
2. Press the [◀] or [▶] button to select "TV DIVER".
3. Turn the [ROTARY] knob clockwise to set to "ON" or counterclockwise to set to "OFF".
 - ON:
Sets reception emphasizing the visual.
 - OFF:
Sets the diver setting to OFF.
4. Press the [TITLE] button to return to the previous mode.

Setting the TV area

When you select the TV area (TV reception area), the TV tuner area setting changes.

1. Press and hold the [TITLE] button for 1 second or longer to switch to the adjustment selection display.
2. Press the [◀] or [▶] button to select "TV AREA".
3. Press the [▶II] button.
4. Turn the [ROTARY] knob clockwise or counterclockwise to select the reception area.
5. Press the [▶II] button.
6. Press the [TITLE] button to return to the previous mode.

The above operations are required when a TV tuner other than TTX7501z is connected.

9. IN CASE OF DIFFICULTY

	Problem	Cause	Measure
General	Power does not turn on. (No sound is produced.)	Fuse is blown.	Replace with a fuse of the same amperage. If the fuse blows again, consult your store of purchase.
		Incorrect wiring.	Consult your store of purchase.
	No sound output when operating the unit with amplifiers or power antenna attached.	Power antenna lead is shorted to ground or excessive current is required for remote-on the amplifiers or power antenna.	<ol style="list-style-type: none"> Turn the unit off. Remove all wires attached to the power antenna lead. Check each wire for a possible short to ground using an ohm meter. Turn the unit back on. Reconnect each amplifier remote wire to the power antenna lead one by one. If the amplifiers turn off before all wires are attached, use an external relay to provide remote-on voltage (excessive current required).
		Nothing happens when buttons are pressed. Display is not accurate.	The microprocessor has malfunctioned due to noise, etc.
	DCP or main unit connectors are dirty.	Wipe the dirt off with a soft cloth moistened with cleaning alcohol.	
CD	Compact disc cannot be loaded.	Another compact disc is already loaded.	Eject the compact disc before loading the new one.
	Sound skips or is noisy.	Compact disc is dirty.	Clean the compact disc with a soft cloth.
		Compact disc is heavily scratched or warped.	Replace with a compact disc with no scratches.
	Sound is bad directly after power is turned on.	Water droplets may form on the internal lens when the car is parked in a humid place.	Let dry for about 1 hour with the power on.

10. ERROR DISPLAYS

If an error occurs, one of the following displays is displayed.
Take the measures described below to eliminate the problem.

	Error Display	Cause	Measure
CD	ERROR 2	A CD is caught inside the CD deck and is not ejected.	This is a failure of CD deck's mechanism and consult your store of purchase.
	ERROR 3	A CD cannot be played due to scratches, etc.	Replace with a non-scratched, non-warped-disc.
	ERROR 6	A CD is loaded upside-down inside the CD deck and does not play.	Eject the disc then reload it properly.
CD changer	ERROR 2	A CD inside the CD changer is not loaded.	This is a failure of CD changer's mechanism and consult your store of purchase.
	ERROR 3	A CD inside the CD changer cannot be played due to scratches, etc.	Replace with a non-scratched, non-warped disc.
	ERROR 6	A CD inside the CD changer cannot be played because it is loaded upside-down.	Eject the disc then reload it properly.
MD changer	ERROR H	Displayed when the temperature in the MD changer is too high and playback has been stopped automatically.	Lower the surrounding temperature and wait for a while to cool off MD changer.
	ERROR 2	An MD inside the MD changer is not loaded.	This is a failure of MD changer's mechanism and consult your store of purchase.
	ERROR 3	An MD inside the MD changer cannot be played due to scratches, etc.	Replace with a non-scratched, non-warped disc.
	ERROR 6	An MD inside the MD changer cannot be played because it is loaded upside-down.	Eject the disc then reload it properly.
		Displayed when a non-recorded MD is loaded in the MD changer.	Load a pre-recorded MD in the MD changer.
DVD changer	ERROR 2	A DISC inside the DVD changer cannot be played.	This is a failure of DVD mechanism and consult your store of purchase.
	ERROR 3	A DISC cannot be played due to scratches, etc.	Retry or replace with a non-scratched, non-warped-disc.
	ERROR 6	A DISC inside the DVD changer cannot be played because it is loaded upside-down.	Eject the disc then reload it properly
	ERROR P	Parental level error	Set the correct Parental level.
	ERROR R	Region code error	Eject the disc and replace correct region code disc.

If an error display other than the ones described above appears, press the reset button. If the problem persists, turn off the power and consult your store of purchase.

11. SPECIFICATIONS

FM Tuner

Frequency Range:
87.0 MHz to 108 MHz

Usable Sensitivity:
9 dBf

50dB Quieting Sensitivity:
15 dBf

Alternate Channel Selectivity:
70 dB

Stereo Separation (1 kHz):
35 dB

Frequency Response (± 3 dB):
30 Hz to 15 kHz

AM Tuner

Frequency Range:
531 kHz to 1602 kHz

Usable Sensitivity:
25 μ V

CD Player

System:
Compact disc digital audio system

Usable Discs:
Compact disc

Frequency Response (± 1 dB):
10 Hz to 20 kHz

Signal to Noise Ratio (1 kHz):
100 dB

Dynamic Range (1 kHz):
95 dB

Harmonic Distortion:
0.01%

Audio

Maximum Power Output:
208 W (52 W \times 4 ch)

Continuous Average Power Output:
17 W \times 4, into 4 Ω , 20 Hz to 20 kHz, 1%THD

Bass Control Action (60 Hz):
 ± 15 dB

Treble Control Action (10 kHz):
 ± 12 dB

Line Output Level (CD 1 kHz):
2 V

General

Power Supply Voltage:
14.4 V DC (10.8 to 15.6 V allowable), negative ground

Current Consumption:
Less than 15 A

Speaker Impedance:
4 Ω (4 Ω to 8 Ω allowable)

Weight / Source unit:
2.64 lb. (1.2 kg)

Weight / Remote control unit:
1 oz. (30 g) (including battery)

Dimensions / Source unit:
7" (Width) \times 2" (Height) \times 6-1/8" (Depth)
[178 (W) \times 50 (H) \times 155 (D) mm]

Dimensions / Remote control unit:
1-3/4" (Width) \times 4-5/16" (Height) \times 1-1/8" (Depth)
[44 (W) \times 110 (H) \times 27 (D) mm]

Note:

- Specifications and design are subject to change without notice for further improvement.

Free Manuals Download Website

<http://myh66.com>

<http://usermanuals.us>

<http://www.somanuals.com>

<http://www.4manuals.cc>

<http://www.manual-lib.com>

<http://www.404manual.com>

<http://www.luxmanual.com>

<http://aubethermostatmanual.com>

Golf course search by state

<http://golfingnear.com>

Email search by domain

<http://emailbydomain.com>

Auto manuals search

<http://auto.somanuals.com>

TV manuals search

<http://tv.somanuals.com>