

Thank you for purchasing this **Clarion** product.

- * Please read this owner's manual in its entirety before operating this equipment.
- * After reading this manual, be sure to keep it in a handy place (e.g., glove compartment).
- * Check the contents of the enclosed warranty card and keep it carefully with this manual.
- * This manual includes the operating procedures of the CD changer, MD changer, AUX, DVD and PHONE MUTE connected via the CeNET cable. The CD changer and MD changer have their own manuals, but no explanations for operating them are described.

Contents

1. FEATURES	2	7. OPERATIONS	12
2. PRECAUTIONS	3	Basic Operations	12
Flip Down Panel	4	Radio Operations	14
Handling Compact Discs	4	CD Operations	16
3. CONTROLS	5	Operations Common to Each Mode	17
4. NOMENCLATURE	6	8. OPERATIONS OF ACCESSORIES	19
Names of the Buttons and their Functions ..	6	CD/MD Changer Operations	19
Major button operations when external equip-	7	9. IN CASE OF DIFFICULTY	21
ment is connected to this unit	7	10. ERROR DISPLAYS	22
Display Items	8	11. SPECIFICATIONS	66
LCD Screen	8		
5. DCP	9		
6. REMOTE CONTROL	10		
Inserting the Batteries	10		
Functions of Remote Control Unit Buttons	11		

1. FEATURES

- Rotary Encoder Volume with Rubber
- Flip Down Detachable Aluminum Face & High Visibility Multi-Color LC Display
- Controller for Optional SIRIUS Tuner Modules
- CD-R/CD-RW Compatible
- Z-Enhancer Plus for Sound Creation with 3 Adjustment Modes (2-Band P.EQ)
- CeNET with Balanced Audio Line Transmission and Dynamic Noise Cancelling
- **MAGITUNE**® FM Reception System
- 8-Times Oversampling Digital Filter and Dual 1-Bit D/A Converters
- Zero-Bit Detector™ Mute Circuit
- 4-Channel RCA Line Level Output with Fader Control
- 2-Channel RCA AUX Input with 3 Level Adjustments

Display Items

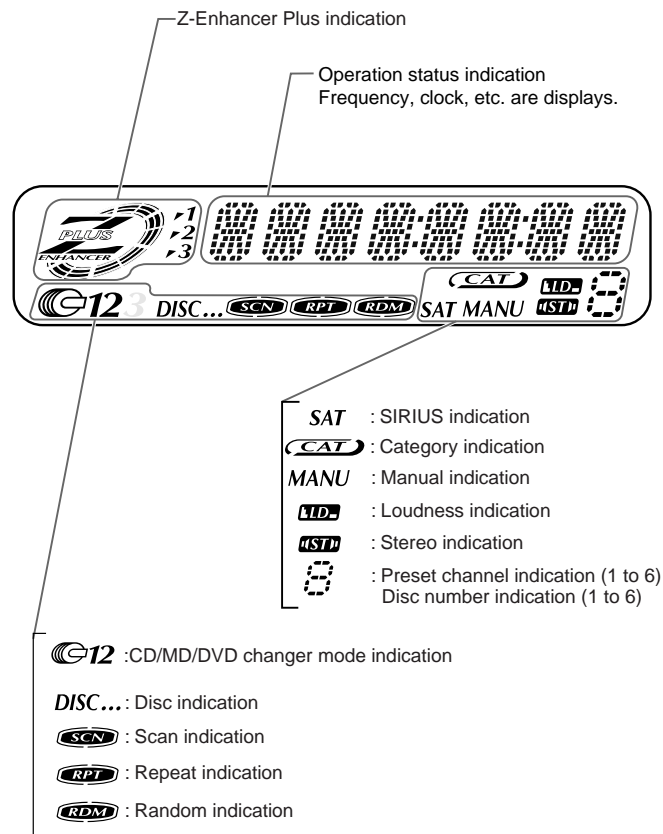

LCD Screen

In extreme cold, the screen movement may slow down and the screen may darken, but this is normal. The screen will recover when it returns to normal temperature.

2. PRECAUTIONS

- When the inside of the car is very cold and the player is used soon after switching on the heater moisture may form on the disc or the optical parts of the player and proper playback may not be possible. If moisture forms on the disc, wipe it off with a soft cloth. If moisture forms on the optical parts of the player, do not use the player for about one hour. The condensation will disappear naturally allowing normal operation.
- Driving on extremely bumpy roads which cause severe vibration may cause the sound to skip.
- This unit uses a precision mechanism. Even in the event that trouble arises, never open the case, disassemble the unit, or lubricate the rotating parts.

This equipment has been tested and found to comply with the limits for a Class B digital device, pursuant to Part 15 of the FCC Rules.

These limits are designed to provide reasonable protection against harmful interference in a residential installation.

This equipment generates, uses, and can radiate radio frequency energy and, if not installed and used in accordance with the instructions, may cause harmful interference to radio communications. However, there is no guarantee that interference will not occur in a particular installation.

If this equipment does cause harmful interference to radio or television reception, which can be determined by turning the equipment off and on, the user is encouraged to consult the dealer or an experienced radio/TV technician for help.

CAUTION

USE OF CONTROLS, ADJUSTMENTS, OR PERFORMANCE OF PROCEDURES OTHER THAN THOSE SPECIFIED HEREIN, MAY RESULT IN HAZARDOUS RADIATION EXPOSURE.

THE COMPACT DISC PLAYER and MINI DISC PLAYER SHOULD NOT BE ADJUSTED OR REPAIRED BY ANYONE EXCEPT PROPERLY QUALIFIED SERVICE PERSONNEL.

CHANGES OR MODIFICATIONS NOT EXPRESSLY APPROVED BY THE MANUFACTURER FOR COMPLIANCE COULD VOID THE USER'S AUTHORITY TO OPERATE THE EQUIPMENT.

INFORMATION FOR USERS:

CHANGES OR MODIFICATIONS TO THIS PRODUCT NOT APPROVED BY THE MANUFACTURER WILL VOID THE WARRANTY AND WILL VIOLATE FCC APPROVAL.

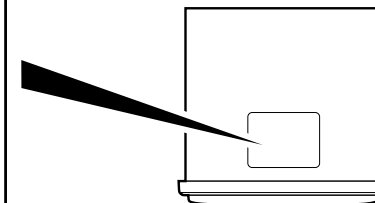

Bottom View of Source Unit

Flip Down Panel

This unit uses a flip-down structure that makes possible large-size displays.

CAUTION

When opening and closing the FLIP DOWN PANEL, be careful not to catch your fingers. They could be injured.

- Always use this unit with the FLIP DOWN PANEL closed.
- Do not force operations or use this device abnormally when opening or closing the FLIP DOWN PANEL.
- Do not use the FLIP DOWN PANEL as a tray to place objects on when it is open.

- When closing the FLIP DOWN PANEL, do not press the [OPEN] button.
- Strong impacts to the operating or display section can cause damage or deformation.
- If the FLIP DOWN PANEL does not open fully, gently open it with your hand.

Handling Compact Discs

Use only compact discs bearing the mark. Do not play heart-shaped, octagonal, or other specially shaped compact discs.

Some CDs recorded in CD-R/CD-RW mode may not be usable.

Handling

- Compared to ordinary music CDs, CD-R and CD-RW discs are both easily affected by high temperature and humidity and some of CD-R and CD-RW discs may not be played. Therefore, do not leave them for a long time in the car.
- New discs may have some roughness around the edges. If such discs are used, the player may not work or the sound may skip. Use a ball-point pen or the like to remove any roughness from the edge of the disc.
- Never stick labels on the surface of the compact disc or mark the surface with a pencil or pen.
- Never play a compact disc with any cellophane tape or other glue on it or with peeling off marks. If you try to play such a compact disc, you may not be able to get it back out of the CD player or it may damage the CD player.

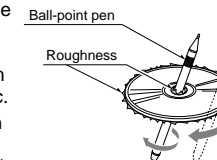

- Do not use compact discs that have large scratches, are misshapen, cracked, etc. Use of such discs may cause misoperation or damage.
- To remove a compact disc from its storage case, press down on the center of the case and lift the disc out, holding it carefully by the edges.
- Do not use commercially available CD protection sheets or discs equipped with stabilizers, etc. These may damage the disc or cause breakdown of the internal mechanism.

Storage

- Do not expose compact discs to direct sunlight or any heat source.
- Do not expose compact discs to excess humidity or dust.
- Do not expose compact discs to direct heat from heaters.

Cleaning

- To remove fingermarks and dust, use a soft cloth and wipe in a straight line from the center of the compact disc to the circumference.
- Do not use any solvents, such as commercially available cleaners, anti-static spray, or thinner to clean compact discs.
- After using special compact disc cleaner, let the compact disc dry off well before playing it.

Be sure to unfold and read the next page. / Veuillez déplier et vous référer à la page suivante. / Cerciórese de desplegar y de leer la página siguiente.

3. CONTROLS / LES COMMANDES / CONTROLES

Source unit / Appareil pilote / Unidad fuente

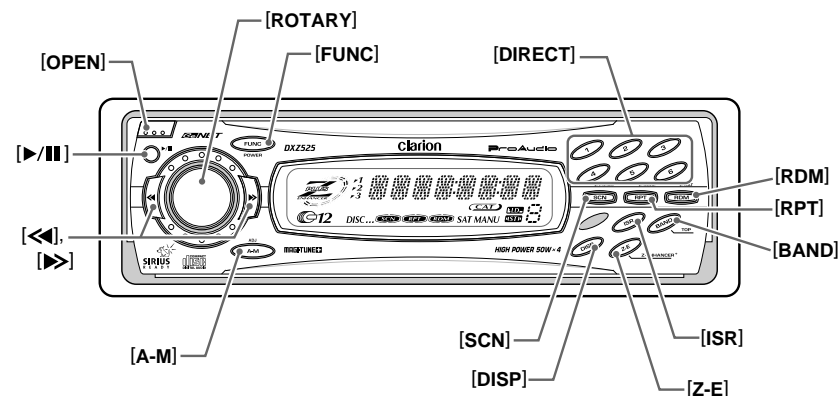

With the FLIP DOWN PANEL opened / Ouvrez le PANNEAU RABATTABLE
Apertura del PANEL ABATIBLE

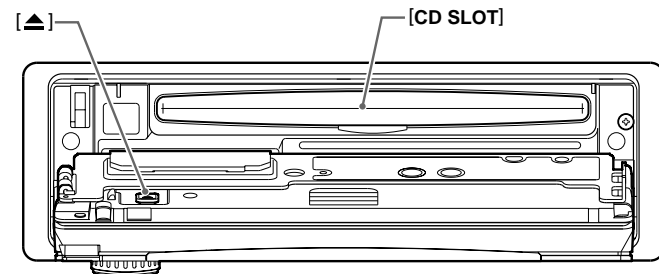

Note: Be sure to unfold this page and refer to the front diagrams as you read each chapter.
Remarque: Veuillez déplier cette page et vous référer aux schémas quand vous lisez chaque chapitre.
Nota: Cuando lea los capítulos, despliegue esta página y consulte los diagramas.

4. NOMENCLATURE

Note:

- Be sure to read this chapter referring to the front diagrams of chapter "3. CONTROLS" on page 5 (unfold).

Names of the Buttons and their Functions

[OPEN] button

- Deeply push in [OPEN] button to unlock the flip down panel.

[ROTARY] knob

- Adjust the volume by turning the knob clockwise or counterclockwise.
- Use the knob to perform various settings.

[FUNC] button

- Press the button to turn on the power. Press and hold the button for 1 second or longer to turn off the power.
- Switches the operation mode among the radio mode, etc.

[DIRECT] button

- Stores a station into memory or recall it directly while in the radio mode.

[RDM] button

- Performs random play while in the CD mode.

[RPT] button

- Repeat play while in the CD mode.

[BAND] button

- Switches the band, or seek tuning or manual tuning while in the radio mode.
- Plays a first track while in the CD mode.

[ISR] button

- Recalls ISR radio station in memory.
- Press and hold for 2 seconds or longer: Stores current station into ISR memory (radio mode only).

[Z-E] button

- Use the button to select one of the three types of sound characteristics already stored in memory.

[DISP] button

- Switches the display indication (Main display, clock display).

[SCN] button

- Performs preset scan while in the radio mode. When the button is pressed and held, auto store is performed.
- Performs scan play for 10 seconds for each track while in the CD mode.

[A-M] button

- Press and hold the button for 1 second or longer to make the System Adjustments.
- Use the button to switch to the audio mode (bass/treble, balance/fader Z-Enhancer Plus, loudness adjustment)

[◀], [▶] button

- Selects a station while in the radio mode or selects a track when listening to a CD. These buttons are used to make various settings.
- Press and hold the button for 1 second or longer to switches the fast-forward/fast-backward.

[▶/II] button

- Plays or pauses a CD while in the CD mode.

[▲] button

- Ejects a CD when it is loaded into the unit.

[CD SLOT]

- CD insertion slot.

Major button operations when external equipment is connected to this unit

● When the CD/MD/DVD changer is connected

- * For details, see the section "CD/MD changer operations". For the DVD changer, refer to the Owner's Manual provided with the DVD changer.

[DIRECT] button

- Designates the disc to be played.

[RDM] button

- Performs random play. Also performs disc random play when the button is pressed and held

[RPT] button

- Performs repeat play. When this button is pressed and held, disc repeat play is performed.

[BAND] button

- Moves the next disc in increasing order.

[SCN] button

- Performs scan play for 10 seconds for each track. Disc scan play is performed when the button is pressed and held.

[◀], [▶] button

- Selects a track when listening to a disc.

- Press and hold the button for 1 second or longer to switches the fast-forward/fast-backward.

[▶/II] button

- Plays or pauses a CD, MD or DVD.

● When the Sirius Satellite Radio is connected

- * For details, refer to the Owner's Manual provided with the Sirius Satellite Radio.

[FUNC] button

- Press the button to switch the operation mode among the SIRIUS mode, etc.

[SCN] button

- Performs category scan while in the SIRIUS mode. When the button is pressed and held, preset scan is performed.

[DIRECT] button

- Stores a station into memory or recall it directly while in the SIRIUS mode.

[◀], [▶] button

- Press the button to selects a station.

What is Sirius Satellite Radio?



Sirius is radio the way it was meant to be: Up to 100 new channels of digital quality programming delivered to listeners coast to coast via satellite. That means 50 channels of completely commercial-free music. Plus up to 50 more channels of news, sports, and entertainment from names like CNBC, Discovery, SCI-FI Channel, A&E, House of Blues, E!, NPR, Speedvision and ESPN.

Sirius is live, dynamic entertainment, completely focused on listeners. Every minute of every day of every week will be different. All 50 commercial-free music channels are created in-house and hosted by DJs who know and love the music. Do you like Reggae? How about Classic Rock or New Rock? Sirius has an array of choices spanning a vast range of musical tastes including the hits of the 50's, 60's, 70's, & 80's as well as Jazz, Country, Blues, Pop, Rap, R&B, Bluegrass, Alternative, Classical, Heavy Metal, Dance and many others...

From its state-of-the-art, digital broadcasting facility in Rockefeller Center, New York City, Sirius will deliver the broadest, deepest mix of radio entertainment from coast to coast.

Sirius will bring you music and entertainment programming that is simply not available on traditional radio in any market across the country. It's radio like you've never heard before.

So Get Sirius and Listen Up! For more information, visit siriusradio.com.

5. DCP

The control panel can be detached to prevent theft. When detaching the control panel, store it in the DCP (DETACHABLE CONTROL PANEL) case to prevent scratches.

We recommend taking the DCP with you when leaving the car.

Removing the DCP

1. Press the [FUNC] button for 1 second or longer to turn off the power.

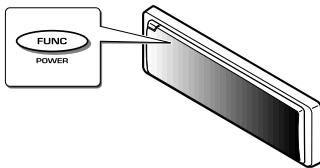

2. Deeply push in [OPEN] button to unlock the flip down panel.

* If the flip down panel does not open fully, gently open it with your hand.

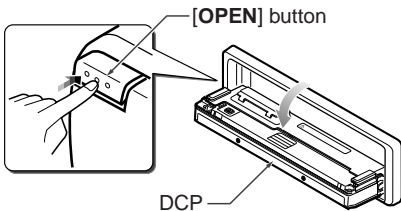

3. Pull the DCP toward you and remove it.

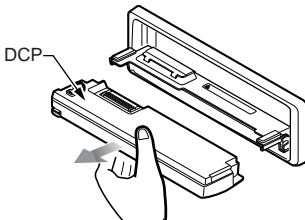

4. Close the HOLD FLAP.

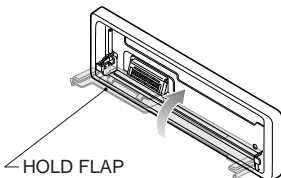

CAUTION

Be sure to close the HOLD FLAP for safety when removing the DCP.

Attaching the DCP

1. Insert the right side of the DCP into the main unit.
2. Insert the left side of the DCP into the main unit.

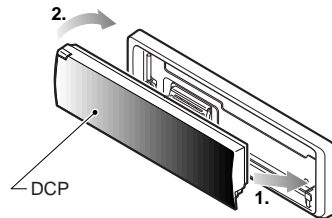

CAUTION

- The DCP can easily be damaged by shocks. After removing it, be careful not to drop it or subject it to strong shocks.
- If the FLIP DOWN PANEL is kept open, the DCP may drop due to vibration of the car. This results in damage to the DCP. So close the FLIP DOWN PANEL or remove the DCP to store into the case.
- The connector connecting the source unit and the DCP is an extremely important part. Be careful not to damage it by pressing on it with fingernails, screwdrivers, etc.

Note:

- If the DCP is dirty, wipe off the dirt with a soft, dry cloth only.

6. REMOTE CONTROL

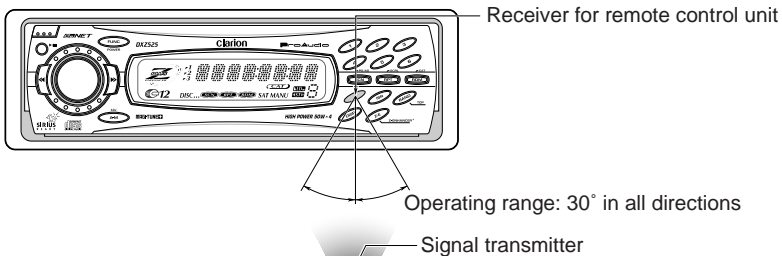

Remote control unit

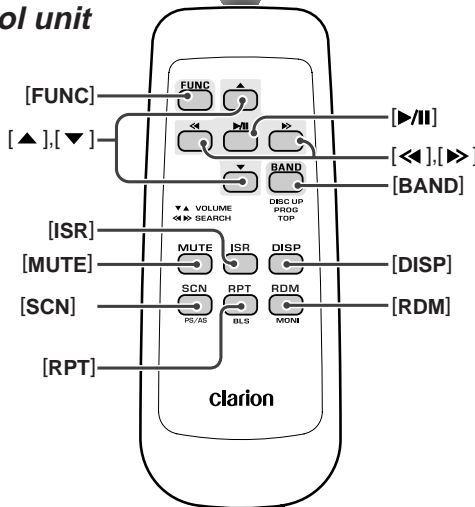

Inserting the Batteries

1. Turn the remote control unit over, then slide the rear cover in the direction of the arrow.
2. Insert the AA (SUM-3, IECR-6/1.5V) batteries that came with the remote control unit facing in the directions shown in the figure, then close the rear cover.

Notes:

Using batteries improperly can cause them to explode. Take note of the following points:

- When replacing batteries, replace both batteries with new ones.
- Do not short-circuit, disassemble or heat batteries.
- Do not dispose of batteries into fire or flames.
- Dispose of spent batteries properly.

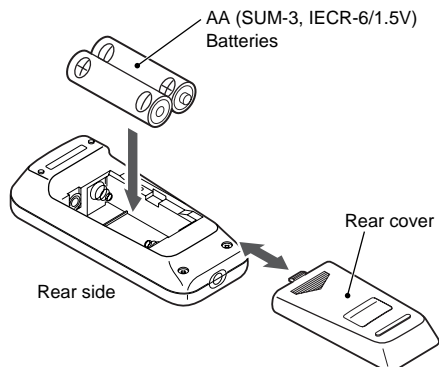

Functions of Remote Control Unit Buttons

Mode Button	Radio	CD	CD/MD changer
[FUNC]	Switches among radio, SIRIUS tuner, CD, CD/MD changer, DVD changer and AUX.		
[BAND]	Switches reception band.	Plays the first track. Top play.	Moves the next disc in increasing order.
[▲], [▼]	Increases and decreases volume (in all modes).		
[◀], [▶]	Moves preset channels up and down.	Moves tracks up and down. When pressed and held for 1 second: Fast-forward/fast-backward.	
[▶/II]	No function.	Switches between playback and pause.	
[MUTE]	Turns mute on and off.		
[ISR]	Recalls ISR radio station in memory. Press and hold for 2 seconds or longer: Stores current station into ISR memory (radio mode only).		
[DISP]	Switches among main display, clock display.		
[SCN]	Preset scan. When pressed and held for 2 seconds: Auto store.	Scan play.	Scan play. When pressed and held for 1 second: Disc scan play.
[RPT]	No function	Repeat play.	Repeat play. When pressed and held for 1 second: Disc repeat play.
[RDM]	No function	Random play.	Random play. When pressed and held for 1 second: Disc random play.

* Some of the corresponding buttons on the main unit and remote control unit have different functions.

7. OPERATIONS

Basic Operations

Note: Be sure to read this chapter referring to the front diagrams of chapter "3. CONTROLS" on page 5 (unfold).

⚠ CAUTION

Be sure to lower the volume before switching off the unit power or the ignition key. The unit remembers its last volume setting. If you switch the power off with the volume up, when you switch the power back on, the sudden loud volume may hurt your hearing and damage the unit.

Turning on/off the power

Note:

• Be careful about using this unit for a long time without running the engine. If you drain the car's battery too far, you may not be able to start the engine and this can reduce the service life of the battery.

1. Press the [FUNC] button.
2. The illumination and display on the unit light up. The unit automatically remembers its last operation mode and will automatically switch to display that mode.
3. Press and hold the [FUNC] button for 1 second or longer to turn off the power for the unit.

Note:

• System check

The first time this unit is turned on after the wire connections are completed, it must check what equipment is connected. When the power is turned on, "SYSTEM" and "PUSH PWR" appear in the display alternately, so press the [FUNC] button. The system check starts within the unit. When the system check is complete, the power is turned off, so press the [FUNC] button again.

Selecting a mode

1. Press the [FUNC] button to change the operation mode.
 2. Each time you press the [FUNC] button, the operation mode changes in the following order:
Radio mode → SIRIUS mode → CD mode → CD changer mode → MD changer mode → DVD changer mode → AUX mode → Radio mode...
- * External equipment not connected with CeNET is not displayed.

Adjusting the volume

Turning the [ROTARY] knob clockwise increases the volume; turning it counterclockwise decreases the volume.

* The volume level is from 0 (minimum) to 33 (maximum).

Switching the display

Press the [DISP] button to select the desired display.

Each time you press the [DISP] button, the display switches in the following order:

Main display



Clock display

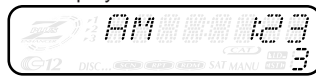

Main display

* Once selected, the preferred display becomes the display default. When a function adjustment such as volume is made, the screen will momentarily switch to that function's display, then revert back to the preferred display several seconds after the adjustment.

Setting the Z-Enhancer Plus

This unit are provided with 3 types of sound tone effects stored in memory. Select the one you prefer.

* The factory default setting is "Z+ OFF".

Each time you press the [Z-E] button, the tone effect changes in the following order:

"Z+ OFF" → "B BOOST" → "IMPACT" → "EXCITE" → "CUSTOM" → "Z+ OFF" ...

- B BOOST : bass emphasized
- IMPACT : bass and treble emphasized
- EXCITE : bass and treble emphasized mid de-emphasized
- CUSTOM : user custom
- Z+ OFF : no sound effect

Adjusting the tone

Press the [A-M] button and select the item to adjust. Each time you press the [A-M] button, the item changes in the following order:

● When “B BOOST” is set

“B BOOST” → “BAL 0” → “FAD 0” → “LOUD OFF” → Last function mode.

● When “IMPACT” is set

“IMPACT” → “BAL 0” → “FAD 0” → “LOUD OFF” → Last function mode.

● When “EXCITE” is set

“EXCITE” → “BAL 0” → “FAD 0” → “LOUD OFF” → Last function mode.

● When “CUSTOM” is set

“BASS” → “TREB” → “BAL 0” → “FAD 0” → “LOUD OFF” → Last function mode.

● When “Z+ OFF” is set

“BAL 0” → “FAD 0” → “LOUD OFF” → Last function mode.

Adjusting the bass (Gain, Frequency, Q-curve)

This adjustment can be performed when the Z-Enhancer Plus is set to “CUSTOM”.

1. Press the [A-M] button and select “BASS”.
2. Turning the [ROTARY] knob clockwise emphasizes the bass; turning it counterclockwise attenuates the bass.
* The factory default setting is “B<G 0>”. (Adjustment range: -6 to +6)
3. Press the [▶▶] or [◀◀] button to select “B<F 60>”.

Turning the [ROTARY] knob clockwise or counterclockwise to select the frequency.

* The factory default setting is “B<F 60>”. (Adjustment 60/100/200 Hz)

4. Press the [▶▶] or [◀◀] button to select “B<Q 1>”.

Turning the [ROTARY] knob clockwise or counterclockwise to select the Q-curve.

* The factory default setting is “B<Q 1>”. (Adjustment 1/1.25/1.5/2)

5. When the adjustment is complete, press the [A-M] button several times until the function mode is reached.

Adjusting the treble (Gain, Frequency)

This adjustment can be performed when the Z-Enhancer Plus is set to “CUSTOM”.

1. Press the [A-M] button and select “TREB”.
2. Turning the [ROTARY] knob clockwise emphasizes the treble; turning it counterclockwise attenuates the treble.
* The factory default setting is “T<G 0>”. (Adjustment range: -6 to +6)
3. Press the [▶▶] or [◀◀] button to select “T<F 10>”.
Turning the [ROTARY] knob clockwise or counterclockwise to select the frequency.
* The factory default setting is “T<F 10>”. (Adjustment 10 kHz/15 kHz)
4. When the adjustment is complete, press the [A-M] button several times until the function mode is reached.

Adjusting the balance

1. Press the [A-M] button and select “BAL”.
2. Turning the [ROTARY] knob clockwise emphasizes the sound from the right speaker; turning it counterclockwise emphasizes the sound from the left speaker.
* The factory default setting is “BAL 0”. (Adjustment range: L13 to R13)
3. When the adjustment is complete, press the [A-M] button several times until the function mode is reached.

Adjusting the fader

1. Press the [A-M] button and select “FAD”.
2. Turning the [ROTARY] knob clockwise emphasizes the sound from the front speakers; turning it counterclockwise emphasizes the sound from the rear speakers.
* The factory default setting is “FAD 0”. (Adjustment range: F12 to R12)
3. When the adjustment is complete, press the [A-M] button several times until the function mode is reached.

Basic Operations

Adjusting the Z-Enhancer Plus

1. Press the [Z-E] button and select the Z-Enhancer Plus mode to adjust.
 2. Press the [A-M] button and turning the [ROTARY] knob clockwise adjusts in the + direction; tuning it counterclockwise adjusts in the - direction.
 - When "B BST 0" selected, you can adjust the bass in the range of -3 to 3.
 - When "IMPACT 0" selected, you can adjust the bass and treble in the range of -3 to 3.
 - When "EXCITE 0" selected, you can adjust the bass and treble in the range of -3 to 3.
- * When Z-Enhancer Plus is selected, press and hold the [Z-E] button for 2 seconds or longer to change the "CUSTOM" mode.
Bass/treble characteristics become flat and the indication "--FLAT--" is shown in the display.
Press the [Z-E] button again to change the "Z+ OFF" mode.

Turning on/off the loudness

The loudness effect emphasizes the bass to create a natural sound tone. When you are listening to music at a low volume, it is recommended to use the loudness effect.

1. Press the [A-M] button to select "LOUD OFF".
2. Turning the [ROTARY] knob clockwise or counterclockwise to select "LOUD ON"(on) or "LOUD OFF"(off).
When loudness effect is turned on, "LD"lights on the display.
* The factory default setting is "LOUD OFF".

Radio Operations

FM reception

For enhanced FM performance the **MAGITUNEES®** tuner includes signal actuated stereo control, Enhanced Multi AGC, Impulse noise reduction circuits and Multipath noise reduction circuits.

Changing the reception area

This unit is initially set to USA frequency intervals of 10kHz for AM and 200kHz for FM. When using it outside the USA, the frequency reception range can be switched to the intervals below.

● Setting the reception area

1. Press the [BAND] button and select the desired radio band (FM or AM).
2. While pressing the [DISP] button, each time you press and hold the number "6" of the [DIRECT] buttons for 2 seconds or longer, the reception area switches from inside the USA to outside the USA or from outside the USA to inside the USA.
* Any station preset memories are lost when the reception area is changed.

Listening to the radio

1. Press the [FUNC] button and select the radio mode. The frequency appears in the display.
2. Press the [BAND] button and select the radio band. Each time the button is pressed, the radio reception band changes in the following order:
FM1 → FM2 → FM3 → AM → FM1...
3. Press the [◀] or [▶] button to tune in the desired station.

Tuning

There are 3 types of tuning mode available, seek tuning, manual tuning and preset tuning.

Seek tuning

- Press the **[BAND]** button and select the desired band (FM or AM).
 - * If "MANU" is lit in the display, press and hold the **[BAND]** button for 1 second or longer. "MANU" in the display goes off and seek tuning is now available.
- Press the **[◀◀]** or **[▶▶]** button to automatically seek a station.

When the **[▶▶]** button is pressed, the station is sought in the direction of higher frequencies; if the **[◀◀]** button is pressed, the station is sought in the direction of lower frequencies.

Manual tuning

There are 2 ways available: Quick tuning and step tuning.

When you are in the step tuning mode, the frequency changes one step at a time. In the quick tuning mode, you can quickly tune the desired frequency.

- Press the **[BAND]** button and select the desired band (FM or AM).
 - * If "MANU" is not lit in the display, press and hold the **[BAND]** button for 1 second or longer. "MANU" is lit in the display and manual tuning is now available.
- Tune into a station.

● Quick tuning:

Press and hold the **[◀◀]** or **[▶▶]** button for 1 second or longer to tune in a station.

● Step tuning:

Press the **[◀◀]** or **[▶▶]** button to manually tune in a station.

Recalling a preset station

A total of 24 preset positions (6-FM1, 6-FM2, 6-FM3, 6-AM) exists to store individual radio stations in memory. Pressing the corresponding **[DIRECT]** button recalls the stored radio frequency automatically.

- Press the **[BAND]** button and select the desired band (FM or AM).
- Press the corresponding **[DIRECT]** button to recall the stored station.
 - * Press and hold one of the **[DIRECT]** buttons for 2 seconds or longer to store that station into preset memory.

Manual memory

- Select the desired station with seek tuning, manual tuning or preset tuning.
- Press and hold one of the **[DIRECT]** buttons for 2 seconds or longer to store the current station into preset memory.

Auto store

Auto store is a function for storing up to 6 stations that are automatically tuned in sequentially. If 6 receivable stations cannot be received, a previously stored station remains unoverwritten at the memory position.

- Press the **[BAND]** button and select the desired band (FM or AM).
- Press and hold the **[SCN]** button for 2 seconds or longer. The stations with good reception are stored automatically to the preset channels.
 - * If auto store is performed in the FM bands, the stations are stored in FM3 even if FM1 or FM2 was chosen for storing stations.

Preset scan

Preset scan receives the stations stored in preset memory in order. This function is useful when searching for a desired station in memory.

- Press the **[SCN]** button.
- When a desired station is tuned in, press the **[SCN]** button again to continue receiving that station.

Note:

- Be careful not to press and hold the **[SCN]** button for 2 seconds or longer, otherwise the auto store function is engaged and the unit starts storing stations.

Instant station recall (ISR)

Instant station recall is a special radio preset that instantly accesses a favorite radio station at a touch of a button. The ISR function even operates with the unit in other modes.

● ISR memory

- Select the station that you wish to store in ISR memory.
- Press and hold the **[ISR]** button for 2 seconds or longer.

● Recalling a station with ISR

In any mode, press the **[ISR]** button to turn on the radio function and tune the selected radio station. "ISR" appears in the display. Press the **[ISR]** button again to return to the previous mode.

CD Operations

Loading a CD

1. Press the [OPEN] button to access the CD SLOT behind the FLIP DOWN PANEL.
2. Insert a CD into the centre of the CD SLOT with the label side facing up. The CD plays automatically after loading.

Notes:

- Never insert foreign objects into the CD SLOT.
- If the CD is not inserted easily, there may be another CD in the mechanism or the unit may require service.
- Discs not bearing the  mark and CD-ROMs cannot be played by this unit.
- Some CDs recorded in CD-R/CD-RW mode may not be usable.

Loading 8 cm compact discs

- * No adapter is required to play an 8 cm CD.
 - * Insert the 8 cm CD into the centre of the insertion slot.
3. Close the FLIP DOWN PANEL.

⚠ CAUTION

Be careful not to catch your hand or fingers while closing the FLIP DOWN PANEL.

Notes:

- If the FLIP DOWN PANEL does not open fully, gently open with your hand.
- After loading a CD, always close the FLIP DOWN PANEL.

Listening to a CD already inserted

Press the [FUNC] button to select the CD mode. Play starts automatically. If no CD is loaded in the unit, "NO DISC" appears in the display.

Pausing play

1. Press the [▶/||] button to pause play. "PAUSE" appears in the display.
2. To resume CD play, press the [▶/||] button again.

Ejecting a CD

1. Press the [OPEN] button to open the FLIP DOWN PANEL.
2. Press the [▲] to eject the CD. Take it out from the ejected position.
3. Close the FLIP DOWN PANEL.

⚠ CAUTION

Be careful not to catch your hand or fingers while closing the FLIP DOWN PANEL.

Notes:

- If the FLIP DOWN PANEL does not open fully, gently open with your hand.
- After taking out the CD, be sure to close the FLIP DOWN PANEL.
- * If a CD (12 cm) is left in the ejected position for 15 seconds, the CD is automatically reloaded (Auto reload).
- * 8 cm CDs are not auto reloaded. Be sure to remove it when ejected.

Note:

- If you force a CD into before auto reloading, this can damage the CD.

Selecting a track

● Track-up

1. Press the [▶▶] button to move ahead to the beginning of the next track.
2. Each time you press the [▶▶] button, the track advances ahead to the beginning of the next track.

● Track-down

1. Press the [◀◀] button to move back to the beginning of the current track.
2. Press the [◀◀] button twice to move to the beginning of the previous track.

Fast-forward/fast-backward

● Fast-forward

Press and hold the [▶▶] button for 1 second or longer.

● Fast-backward

Press and hold the [◀◀] button for 1 second or longer.

Top function

The top function resets the CD player to the first track of the disc. Press the [BAND] button to play the first track (track No. 1) on the disc.

Scan play

The scan play locates and plays the first 10 seconds of each track on a disc automatically. This function continues on the disc until it is cancelled.

* The scan play is useful when you want to select a desired track.

1. Press the [**SCN**] button to start scan play. "**SCN**" lights in the display.
2. To cancel the scan play, press the [**SCN**] button again. "**SCN**" goes off from the display and the current track continues to play.

Repeat play

The repeat play continuously plays the current track. This function continues automatically until it is cancelled.

1. Press the [**RPT**] button. "**RPT**" lights in the display and the current track is repeated.
2. To cancel the repeat play, press the [**RPT**] button again. "**RPT**" goes off from the display and normal play resumes.

Random play

The random play selects and plays individual tracks on a disc in no particular order. This function continues automatically until it is cancelled.

1. Press the [**RDM**] button. "**RDM**" lights in the display, an individual track is selected randomly and play begins.
2. To cancel the random play, press the [**RDM**] button again. "**RDM**" goes off and normal play resumes.

Operations Common to Each Mode

Hi / Lo dimmer control

You can adjust the reduced illumination level of the dimmer.

* The factory default setting is "**ON**".

1. Press and hold the [**A-M**] button for 1 second or longer to switch to the adjustment selection display.
2. Press the [**◀◀**] or [**▶▶**] button to select "**DIMMER**".
3. Turn the [**ROTARY**] knob clockwise to "**ON**" or counterclockwise to "**OFF**".
4. Press the [**A-M**] button to return to the previous mode.

AUX function

This system has an external input jack so you can listen to sounds and music from external devices connected to this unit.

Selecting AUX IN sensitivity

Make the following settings to select the sensitivity when sounds from external devices connected to this unit are difficult to hear even after adjusting the volume.

* The factory default setting is "**MID**".

1. Press and hold the [**A-M**] button for 1 second or longer to switch to the adjustment selection display.
2. Press the [**◀◀**] or [**▶▶**] button and select "**AUX SENS**".
3. Turn the [**ROTARY**] knob clockwise or counterclockwise as needed and select from "**HIGH**", "**MID**" or "**LOW**".
4. Press the [**A-M**] button to return to the previous mode.

Setting the clock

1. Press and hold the [**A-M**] button for 1 second or longer to switch to the adjustment selection display.
2. Press the [**◀◀**] or [**▶▶**] button to select "**CLOCK En**".
3. Press the [**▶/II**] button.
4. Press the [**◀◀**] or [**▶▶**] button to select the hour or the minute.

Operations Common to Each Mode

5. Turn the [ROTARY] knob clockwise or counterclockwise to set the correct time.
 - * The clock is displayed in 12-hour format.
6. Press the [▶/||] button to store the time into memory.
7. Press the [A-M] button to return to the previous mode.

Note:

- You cannot set the clock when it is displayed with only the ignition on. If you drain or remove the car's battery or take out this unit, the clock is reset. While setting the clock, if another button or operation is selected, the clock set mode is canceled.

Turning the screen saver function on or off

This unit is provided with the screen saver function. You can turn on and off this function.

If the button operation is performed with the screen saver function on, the operation display corresponding to the button operation is shown for about 30 seconds and the display returns to the screen saver display.

* The factory default setting is "ON".

1. Press and hold the [A-M] button for 1 second or longer to switch to the adjustment selection display.
2. Press the [◀◀] or [▶▶] button and select "AUTO SS".
3. Turn the [ROTARY] knob clockwise or counterclockwise to select "ON" or "OFF".
4. Press the [A-M] button to return to the previous mode.

* The following illustration presents one of the patterns which are shown when the screen saver function is turned on.



Triggered audio mute for cellular telephones

This unit requires special wiring to mute the audio signal automatically when a cellular telephone rings in the car.

- * This function is not compatible with all cellular telephones. Contact your local authorized Clarion dealer for information on proper installation and compatibility.

8. OPERATIONS OF ACCESSORIES

CD/MD Changer Operations

CD/MD changer functions

When an optional CD/MD changer is connected through the CeNET cable, this unit controls all CD/MD changer functions. This unit can control a total of 2 changers (MD and/or CD).

Press the **[FUNC]** button and select the CD(MD) changer mode to start play. If 2 CD(MD) changers are connected, press the **[FUNC]** button to select the CD(MD) changer for play.

- * If **"NO MAGA"** appears in the display, insert the magazine into the CD changer. **"DISC CHK"** appears in the display while the player loads (checks) the magazine.
- * If **"NO DISC"** appears in the display, eject the magazine and insert discs into each slot. Then, reinsert the magazine back into the CD changer.
- * If **"NO DISC"** appears in the display, load MDs into the MD changer.

⚠ CAUTION

CD-ROM discs cannot be played in the CD changer.

Pausing play

1. Press the **[▶/||]** button to pause play. **"PAUS"** appears in the display.
2. To resume play, press the **[▶/||]** button again.

Selecting a CD

Each **[DIRECT]** button corresponds to a disc loaded into the magazine.

● Selecting a disc from 1 to 6

Press the corresponding **[DIRECT]** button (1 to 6) to select the desired disc.

● Selecting a disc from 7 to 12 (only when a 12 disc CD changer is used.)

Press and hold the **[DIRECT]** button (1 to 6) for 1 second or longer to select the desired disc.

- * If a CD is not loaded in a slot of magazine, pressing the **[DIRECT]** button corresponding to its disc number is invalid.

Selecting an MD

Each **[DIRECT]** button corresponds to an MD loaded into the MD changer. Press the corresponding **[DIRECT]** button (1 to 6) to select the desired disc.

- * If an MD is not loaded in a slot of MD changer, pressing the **[DIRECT]** button corresponding to its disc number is invalid.

Selecting a track

● Track-up

1. Press the **[▶▶]** button to move ahead to the beginning of the next track.
2. Each time you press the **[▶▶]** button, the track advances ahead to the beginning of the next track.

● Track-down

1. Press the **[◀◀]** button to move back to the beginning of the current track.
2. Press the **[◀◀]** button twice to move to the beginning of the previous track.

Fast-forward/fast-backward

● Fast-forward

Press and hold the **[▶▶]** button for 1 second or longer.

● Fast-backward

Press and hold the **[◀◀]** button for 1 second or longer.

Top function(CD)

The top function plays from the first track (track No. 1) of the disc.

● When playing a disc 1 to 6

Press the **[DIRECT]** button (1 to 6) with the same number as the CD playing.

● When playing a disc 7 to 12 (only when a 12 disc CD changer is used.)

Press and hold for 1 second or longer the **[DIRECT]** button (1 to 6) with the same number as the CD playing.

- * If a CD is not loaded in a slot of magazine, pressing the **[DIRECT]** button corresponding to its disc number is invalid.

CD/MD Changer Operations

Top function(MD)

The top function plays from the first track (track No. 1) of the disc. Press the **[DIRECT]** button (1 to 6) with the same number as the MD playing.

* If an MD is not loaded in a slot of MD changer, pressing the **[DIRECT]** button corresponding to its disc number is invalid.

Scan play

Scan play locates and plays the first 10 seconds of each track on a disc automatically. This function continues on the disc until it is cancelled.

* The scan play is useful when you want to select a desired track.

1. Press the **[SCN]** button to start track scanning. "SCN" lights in the display.
2. To cancel the scan play, press the **[SCN]** button again. "SCN" goes off from the display and the current track continues to play.

Disc scan play

Disc scan play locates and plays the first 10 seconds of the first track on each disc in the currently selected CD (MD) changer. This function continues automatically until it is cancelled.

* Disc scan play is useful when you want to select a desired CD (MD).

1. Press and hold the **[SCN]** button for 1 second or longer. "DISC" and "SCN" light in the display and disc scan play starts.
2. To cancel disc scan play, press the **[SCN]** button again. "DISC" and "SCN" go off from the display and the current track continues to play.

Repeat play

Repeat play continuously plays the current track. This function continues automatically until it is cancelled.

1. Press the **[RPT]** button. "RPT" lights in the display and the current track is repeated.
2. To cancel repeat play, press the **[RPT]** button again. "RPT" goes off from the display and normal play resumes.

Disc repeat play

After all the tracks on the current disc have been played, disc repeat play automatically replays the current disc over from the first track. This function continues automatically until it is cancelled.

1. Press and hold the **[RPT]** button for 1 second or longer. "DISC" and "RPT" light in the display and disc repeat play starts.
2. To cancel disc repeat play, press and hold the **[RPT]** button again. "DISC" and "RPT" go off from the display and normal play resumes on the current track.

Random play

Random play selects and plays individual tracks on the disc in no particular order. This function continues automatically until it is cancelled.

1. Press the **[RDM]** button. "RDM" lights in the display and random play begins.
2. To cancel random play, press the **[RDM]** button again. "RDM" goes off from the display and normal play resumes.

Disc random play

The disc random play selects and plays individual tracks or discs automatically in no particular order. This function continues automatically until it is cancelled.

1. Press and hold the **[RDM]** button for 1 second or longer. "DISC" and "RDM" light in the display and disc random play starts.
2. To cancel disc random play, press and hold the **[RDM]** button again. "DISC" and "RDM" go off from the display and normal play resumes from the current track.

9. IN CASE OF DIFFICULTY

	Problem	Cause	Measure
General	Power does not turn on. (No sound is produced.)	Fuse is blown.	Replace with a fuse of the same amperage. If the fuse blows again, consult your store of purchase.
		Incorrect wiring.	Consult your store of purchase.
	No sound output when operating the unit with amplifiers or power antenna attached.	Power antenna lead is shorted to ground or excessive current is required for remote-on the amplifiers or power antenna.	<ol style="list-style-type: none"> 1. Turn the unit off. 2. Remove all wires attached to the power antenna lead. Check each wire for a possible short to ground using an ohm meter. 3. Turn the unit back on. 4. Reconnect each amplifier remote wire to the power antenna lead one by one. If the amplifiers turn off before all wires are attached, use an external relay to provide remote-on voltage (excessive current required).
		Nothing happens when buttons are pressed. Display is not accurate.	The microprocessor has malfunctioned due to noise, etc.
	DCP or main unit connectors are dirty.	Wipe the dirt off with a soft cloth moistened with cleaning alcohol.	
CD	Compact disc cannot be loaded.	Another compact disc is already loaded.	Eject the compact disc before loading the new one.
	Sound skips or is noisy.	Compact disc is dirty.	Clean the compact disc with a soft cloth.
		Compact disc is heavily scratched or warped.	Replace with a compact disc with no scratches.
Sound is bad directly after power is turned on.	Water droplets may form on the internal lens when the car is parked in a humid place.	Let dry for about 1 hour with the power on.	

10. ERROR DISPLAYS

If an error occurs, one of the following displays is displayed.

Take the measures described below to eliminate the problem.

	Error Display	Cause	Measure
CD	ERROR 2	A CD is caught inside the CD deck and is not ejected.	This is a failure of CD deck's mechanism and consult your store of purchase.
	ERROR 3	A CD cannot be played due to scratches, etc.	Replace with a non-scratched, non-warped-disc.
	ERROR 6	A CD is loaded upside-down inside the CD deck and does not play.	Eject the disc then reload it properly.
CD changer	ERROR 2	A CD inside the CD changer is not loaded.	This is a failure of CD changer's mechanism and consult your store of purchase.
	ERROR 3	A CD inside the CD changer cannot be played due to scratches, etc.	Replace with a non-scratched, non-warped disc.
	ERROR 6	A CD inside the CD changer cannot be played because it is loaded upside-down.	Eject the disc then reload it properly.
MD changer	ERROR H	Displayed when the temperature in the MD changer is too high and playback has been stopped automatically.	Lower the surrounding temperature and wait for a while to cool off MD changer.
	ERROR 2	An MD inside the MD changer is not loaded.	This is a failure of MD changer's mechanism and consult your store of purchase.
	ERROR 3	An MD inside the MD changer cannot be played due to scratches, etc.	Replace with a non-scratched, non-warped disc.
	ERROR 6	An MD inside the MD changer cannot be played because it is loaded upside-down.	Eject the disc then reload it properly.
		Displayed when a non-recorded MD is loaded in the MD changer.	Load a pre-recorded MD in the MD changer.

If an error display other than the ones described above appears, press the reset button. If the problem persists, turn off the power and consult your store of purchase.

11. SPECIFICATIONS

FM Tuner

Frequency Range:
87.9 MHz to 107.9 MHz

Usable Sensitivity:
9 dBf

50dB Quieting Sensitivity:
15 dBf

Alternate Channel Selectivity:
70 dB

Stereo Separation (1 kHz):
35 dB

Frequency Response (± 3 dB):
30 Hz to 15 kHz

AM Tuner

Frequency Range:
530 kHz to 1710 kHz

Usable Sensitivity:
25 μ V

CD Player

System:
Compact disc digital audio system

Usable Discs:
Compact disc

Frequency Response (± 1 dB):
10 Hz to 20 kHz

Signal to Noise Ratio (1 kHz):
100 dBA

Dynamic Range (1 kHz):
95 dB

Harmonic Distortion:
0.01%

Channel Separation (1 kHz):
85 dB

Audio

Maximum Power Output:
200 W (50 W \times 4 ch)

Continuous Average Power Output:
18 W \times 4, into 4 Ω , 20 Hz to 20 kHz, 1%THD

Bass Control Action (60 Hz/100 Hz/200 Hz):
 ± 15 dB

Treble Control Action (10 kHz/15 kHz):
 ± 12 dB

Line Output Level (CD 1 kHz):
2 V

General

Power Supply Voltage:
14.4 V DC (10.8 to 15.6 V allowable), negative ground

Current Consumption:
Less than 15 A

Speaker Impedance:
4 Ω (4 Ω to 8 Ω allowable)

Weight / Source unit:
3.30 lb. (1.5 kg)

Weight / Remote control unit:
1 oz. (30 g) (including battery)

Dimensions / Source unit:
7" (Width) \times 2" (Height) \times 6-1/8" (Depth)
[178 (W) \times 50 (H) \times 155 (D) mm]

Dimensions / Remote control unit:
1-3/4" (Width) \times 4-5/16" (Height) \times 1-1/8" (Depth)
[44 (W) \times 110 (H) \times 27 (D) mm]

Notes:

- Specifications and design are subject to change without notice for further improvement.

11. SPÉCIFICATIONS

Tuner FM

Plage de fréquence :
87,9 à 107,9 MHz

Sensibilité utilisable :
9 dBf

Seuil de sensibilité à 50dB :
15 dBf

Sélectivité de canal de substitution :
70 dB

Séparation stéréo (1 kHz) :
35 dB

Réponse en fréquence (± 3 dB) :
30 Hz à 15 kHz

Tuner AM

Plage de fréquence :
530 kHz à 1710 kHz

Sensibilité utilisable :
25 μ V

Lecteur CD

Système :
Système audionumérique de disque compact

Disques utilisables :
Disques compacts

Réponse en fréquence (± 1 dB) :
10 Hz à 20 kHz

Rapport signal/bruit (1 kHz) :
100 dBA

Plage dynamique (1 kHz) :
95 dB

Distorsion harmonique :
0,01%

Séparation des canaux (1 kHz):
85 dB

Remarques :

- La conception et les spécifications sont sujettes à modification sans préavis pour des raisons d'amélioration.

Audio

Puissance de sortie maximale :
200 W (50 W \times 4 canaux)

Puissance de sortie continue moyenne :
18 W \times 4, à 4 W, 20 Hz à 20 kHz, DHT 1%

Plage de variation des graves (60 Hz/100 Hz/
200 Hz) :
 ± 15 dB

Plage de variation des aigus (10 kHz/15 kHz) :
 ± 12 dB

Sortie de ligne (CD 1 kHz) :
2 V

Données générales

Tension d'alimentation :
14,4 V CC (10,8 V à 15,6 V admissible),
masse négative

Consommation :
Inférieure à 15 A

Impédance de haut-parleurs :
4 Ω (4 Ω à 8 Ω admissible)

Poids / Appareil pilote :
3,30 lb. (1,5 kg)

Poids / Télécommande :
1 oz. (30 g) (avec la pile)

Dimensions / Appareil pilote :
7" (largeur) \times 2" (hauteur) \times 6-1/8" (profondeur)
[178 (L) \times 50 (H) \times 155 (P) mm]

Dimensions / Télécommande :
1-3/4" (largeur) \times 4-5/16" (hauteur) \times 1-1/8" (profondeur)
[44 (L) \times 110 (H) \times 27 (P) mm]

11. ESPECIFICACIONES

Sintonizador de FM

- Gama de frecuencias:
87,9 a 107,9 MHz
- Sensibilidad útil:
9 dBf
- Sensibilidad a 50 dB de silenciamiento:
15 dBf
- Selectividad de canal alternativo:
70 dB
- Separación entre canales (1 kHz):
35 dB
- Respuesta en frecuencia (± 3 dB):
30 Hz a 15 kHz

Sintonizador de AM

- Gama de frecuencias:
530 a 1710 kHz
- Sensibilidad útil:
25 μ V

Reproductor de discos compactos

- Sistema:
Sistema audiodigital de discos compactos
- Discos utilizables:
Discos compactos
- Respuesta en frecuencia (± 1 dB):
10 Hz a 20 kHz
- Relación señal-ruido (1 kHz):
100 dBA
- Gama dinámica (1 kHz):
95 dB
- Distorsión armónica:
0,01%
- Separación entre canales (1 kHz):
85 dB

Notas:

- Las especificaciones y el diseño están sujetos a cambio sin previo aviso por motivo de mejoras.

Audio

- Salida máxima de potencia:
200 W (50 W \times 4 canales)
- Salida media continua de potencia:
18 W \times 4, con 4 Ω , de 20 Hz a 20 kHz, 1% de distorsión armónica total
- Acción de control de graves (60 Hz/100 Hz/
200 Hz):
 ± 15 dB
- Acción de control de agudos (10 kHz/15 kHz):
 ± 12 dB
- Salida de línea (reproductor de discos compactos 1 kHz):
2 V

Generales

- Tensión de alimentación:
14,4 V CC (permisible de 10,8 a 15,6 V),
negativo a masa
- Consumo de corriente:
Menos de 15 A
- Impedancia de los altavoces:
4 Ω (permisible de 4 a 8 Ω)
- Peso / Unidad fuente:
3,30 lb. (1,5 kg)
- Peso / Controlador remoto:
1 oz. (30 g) (incluyendo la pila)
- Dimensiones / Unidad fuente:
7" (An) \times 2" (Al) \times 6-1/8" (Prf)
[178 (An) \times 50 (Al) \times 155 (Prf) mm]
- Dimensiones / Controlador remoto:
1-3/4" (An) \times 4-5/16" (Al) \times 1-1/8" (Prf)
[44 (An) \times 110 (Al) \times 27 (Prf) mm]

Free Manuals Download Website

<http://myh66.com>

<http://usermanuals.us>

<http://www.somanuals.com>

<http://www.4manuals.cc>

<http://www.manual-lib.com>

<http://www.404manual.com>

<http://www.luxmanual.com>

<http://aubethermostatmanual.com>

Golf course search by state

<http://golfingnear.com>

Email search by domain

<http://emailbydomain.com>

Auto manuals search

<http://auto.somanuals.com>

TV manuals search

<http://tv.somanuals.com>