

# clarion®

**Owner's manual**  
**Mode d'emploi**  
**Manual de instrucciones**

## ***DXZ585USB***

---

**CD/USB/MP3/WMA/AAC RECEIVER WITH CeNET CONTROL**  
**AUTORADIO CD/USB/MP3/WMA/AAC / AVEC COMMANDE CeNET**  
**RECEPTOR CD/USB/MP3/WMA/AAC CON CONTROL CeNET**

This equipment has been tested and found to comply with the limits for a Class B digital device, pursuant to Part 15 of the FCC Rules.

These limits are designed to provide reasonable protection against harmful interference in a residential installation.

This equipment generates, uses, and can radiate radio frequency energy and, if not installed and used in accordance with the instructions, may cause harmful interference to radio communications. However, there is no guarantee that interference will not occur in a particular installation.

If this equipment does cause harmful interference to radio or television reception, which can be determined by turning the equipment off and on, the user is encouraged to consult the dealer or an experienced radio/TV technician for help.

Cet appareil a été testé et jugé conforme aux limites des appareils numériques de Classe B, aux termes de la Section 15 des Règlements FCC.

Ces limites ont pour but d'assurer une protection raisonnable contre les interférences parasites dans une installation résidentielle.

Cet appareil engendre, utilise et peut émettre une énergie radioélectrique et, s'il n'est pas installé et utilisé en stricte conformité avec ces instructions, il peut provoquer des interférences parasites sur les liaisons radiophoniques. Ceci ne garantit par pour autant qu'une installation particulière ne provoquera aucune interférence.

Si l'appareil engendre des interférences sur la réception des ondes radio ou de télévision, ce qui peut être vérifié en mettant l'appareil hors tension puis sous tension, l'utilisateur est invité à consulter son revendeur ou un technicien expérimenté en radio/télévision pour lui demander conseil.

Este equipo ha sido probado y se ha comprobado que cumple con los límites de un dispositivo digital de clase B, según lo indicado en la Parte 15 de las Normas de FCC.

Estos límites se han establecido para ofrecer una protección razonable contra interferencias perjudiciales en instalaciones residenciales.

Este equipo genera, emplea, y puede radiar energía de radiofrecuencia y, si no se instala y emplea de acuerdo con las instrucciones, puede causar interferencias perjudiciales en las radiocomunicaciones. Sin embargo, no se garantiza que las interferencias no ocurran en una instalación en particular.

Si este equipo causa interferencias perjudiciales en la recepción de radio o de televisión, lo cual podrá determinarse conectando y desconectando la alimentación del equipo, se aconseja al usuario que consulte al abastecedor o que pida ayuda a un técnico en radio/televisión experimentado.

MODEL	<input type="text"/>	Clarion
<b>12V <math>\ominus</math> GROUND</b> <b>AM 530-1710kHz/FM 87.9-107.9MHz</b>		
<small>THIS DEVICE COMPLIES WITH PART 15 OF THE FCC RULES. OPERATION IS SUBJECT TO THE FOLLOWING TWO CONDITIONS:          (1) THIS DEVICE MAY NOT CAUSE HARMFUL INTERFERENCE, AND          (2) THIS DEVICE MUST ACCEPT ANY INTERFERENCE RECEIVED, INCLUDING INTERFERENCE THAT MAY CAUSE UNDESired OPERATION.</small>		
<small>THIS PRODUCTION COMPLIES WITH DHHS RULES 21 CFR SUBCHAPTER J APPLICABLE AT DATE OF MANUFACTURE.</small>		
<small>CLARION CO., LTD.          7-2, SHINTOSHIN, CHUO-KU, SAITAMA-SHI, SAITAMA 330-0081, JAPAN</small>		
<small>This product includes technology owned by Microsoft Corporation and cannot be used or distributed without a license from MSLGP.</small>		
MANUFACTURED:		
		
SERIAL No.	<input type="text"/>	276- <input type="text"/>
PE	<input type="text"/>	Clarion Co., Ltd. MADE IN <input type="text"/>

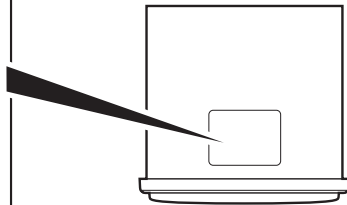

**Bottom View of Source Unit**  
**Fond de l'appareil pilote**  
**Vista inferior de la unidad fuente**

# CLARION PRODUCT REGISTRATION INFORMATION

For USA and Canada only  
[www.clarion.com](http://www.clarion.com)

Dear Customer:

Congratulations on your purchase of a Clarion mobile electronic products. We are confident that you'll enjoy your Clarion experience.

There are many benefits to registering your product. We invite you to visit our website at [www.clarion.com](http://www.clarion.com) to register your Clarion product.

We have made product registration simple with our easy to use website. The registration form is short and easy to complete. Once you're registered, we can keep you informed of important product information.

Register at [www.clarion.com](http://www.clarion.com) - it's easy to keep your Clarion product up to date.

Thank you for purchasing this **Clarion** product.

- \* Please read this owner's manual in its entirety before operating this equipment.
- \* After reading this manual, be sure to keep it in a handy place (e.g., glove compartment).
- \* Check the contents of the enclosed warranty card and keep it carefully with this manual.

## Contents

<b>1. FEATURES</b> .....	<b>4</b>
<b>2. PRECAUTIONS</b> .....	<b>4</b>
Flip Down Panel .....	4
Handling Compact Discs .....	5
<b>3. CONTROLS</b> .....	<b>6</b>
Names of the Buttons and Their Functions .....	7
Display Items .....	8
Display Screen .....	8
<b>4. DCP (DETACHABLE CONTROL PANEL)</b> .....	<b>9</b>
<b>5. REMOTE CONTROL</b> .....	<b>10</b>
Inserting the Battery .....	10
Functions of Remote Control Unit Buttons .....	11
<b>6. OPERATIONS</b> .....	<b>13</b>
Basic Operations .....	13
Radio Operations .....	17
CD/MP3/WMA/AAC Operations .....	19
Operations Common to Each Mode .....	24
<b>7. ACCESSORIES</b> .....	<b>27</b>
USB/MTP Operations .....	27
iPod Operations .....	29
Satellite Radio Operations .....	31
CD Changer Operations .....	33
DVD Changer Operations .....	34
TV Operations .....	35
<b>8. TROUBLESHOOTING</b> .....	<b>36</b>
<b>9. ERROR DISPLAYS</b> .....	<b>38</b>
<b>10. SPECIFICATIONS</b> .....	<b>39</b>
<b>11. OTHERS</b> .....	<b>40</b>

# 1. FEATURES



- 6ch/6V RCA Output / 53W X 4 Built-in MOSFET Amplifier
- USB Audio for iPod®
- USB Digital Media Streaming Capability

- \* "iPod" is for legal or rightholder-authorized copying only. Don't steal music.
- "iPod" is a trademark of Apple Inc., registered in the U.S. and other countries.
- \* XM and the XM logos are trademarks of XM Satellite Radio Inc.

## 2. PRECAUTIONS

1. When the inside of the car is very cold and the player is used soon after switching on the heater moisture may form on the disc or the optical parts of the player and proper playback may not be possible. If moisture forms on the disc, wipe it off with a soft cloth. If moisture forms on the optical parts of the player, do not use the player for about one hour. The condensation will disappear naturally allowing normal operation.
2. Driving on extremely bumpy roads which cause severe vibration may cause the sound to skip.
3. This unit uses a precision mechanism. Even in the event that trouble arises, never open the case, disassemble the unit, or lubricate the rotating parts.

### ⚠ CAUTION

**USE OF CONTROLS, ADJUSTMENTS, OR PERFORMANCE OF PROCEDURES OTHER THAN THOSE SPECIFIED HEREIN, MAY RESULT IN HAZARDOUS RADIATION EXPOSURE.**

**THE COMPACT DISC PLAYER SHOULD NOT BE ADJUSTED OR REPAIRED BY ANYONE EXCEPT PROPERLY QUALIFIED SERVICE PERSONNEL.**

**CHANGES OR MODIFICATIONS NOT EXPRESSLY APPROVED BY THE MANUFACTURER FOR COMPLIANCE COULD VOID THE USER'S AUTHORITY TO OPERATE THE EQUIPMENT.**

### **INFORMATION FOR USERS:**

**CHANGES OR MODIFICATIONS TO THIS PRODUCT NOT APPROVED BY THE MANUFACTURER WILL VOID THE WARRANTY AND WILL VIOLATE FCC APPROVAL.**

## Flip Down Panel

This unit uses a flip-down structure that makes possible large-size displays.

### ⚠ CAUTION

**When opening and closing the FLIP DOWN PANEL, be careful not to catch your fingers. They could be injured.**



1. Always use this unit with the FLIP DOWN PANEL closed.
2. Do not force operations or use this device abnormally when opening or closing the FLIP DOWN PANEL.

## Flip Down Panel

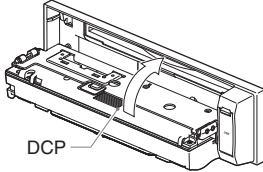
3. Do not use the FLIP DOWN PANEL as a tray to place objects on when it is open.
4. When closing the FLIP DOWN PANEL, do not press the [OPEN] button.
  - \* Press the center of the DCP to close.
5. Strong impacts to the operating or display section can cause damage or deformation.
6. If the FLIP DOWN PANEL does not open fully, gently open it with your hand.



## Handling Compact Discs

Use only compact discs bearing the  or  mark.

Do not play heart-shaped, octagonal, or other specially shaped compact discs.

Some CDs recorded in CD-R/CD-RW mode may not be usable.

### Handling

- Compared to ordinary music CDs, CD-R and CD-RW discs are both easily affected by high temperature and humidity and some of CD-R and CD-RW discs may not be played. Therefore, do not leave them for a long time in the car.
- New discs may have some roughness around the edges. If such discs are used, the player may not work or the sound may skip. Use a ball-point pen or the like to remove any roughness from the edge of the disc.
- Never stick labels on the surface of the compact disc or mark the surface with a pencil or pen.
- Never play a compact disc with any cellophane tape or other glue on it or with peeling off marks. If you try to play such a compact disc, you may not be able to get it back out of the CD player or it may damage the CD player.
- Do not use compact discs that have large scratches, are misshapen, cracked, etc. Use

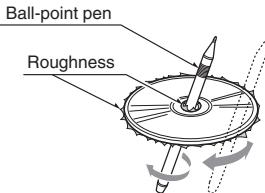

of such discs may cause misoperation or damage.

- To remove a compact disc from its storage case, press down on the center of the case and lift the disc out, holding it carefully by the edges.
- Do not use commercially available CD protection sheets or discs equipped with stabilizers, etc. These may damage the disc or cause breakdown of the internal mechanism.

### Storage

- Do not expose compact discs to direct sunlight or any heat source.
- Do not expose compact discs to excess humidity or dust.
- Do not expose compact discs to direct heat from heaters.

### Cleaning

- To remove fingermarks and dust, use a soft cloth and wipe in a straight line from the center of the compact disc to the circumference.
- Do not use any solvents, such as commercially available cleaners, anti-static spray, or thinner to clean compact discs.
- After using special compact disc cleaner, let the compact disc dry off well before playing it.

# 3. CONTROLS

## Source unit

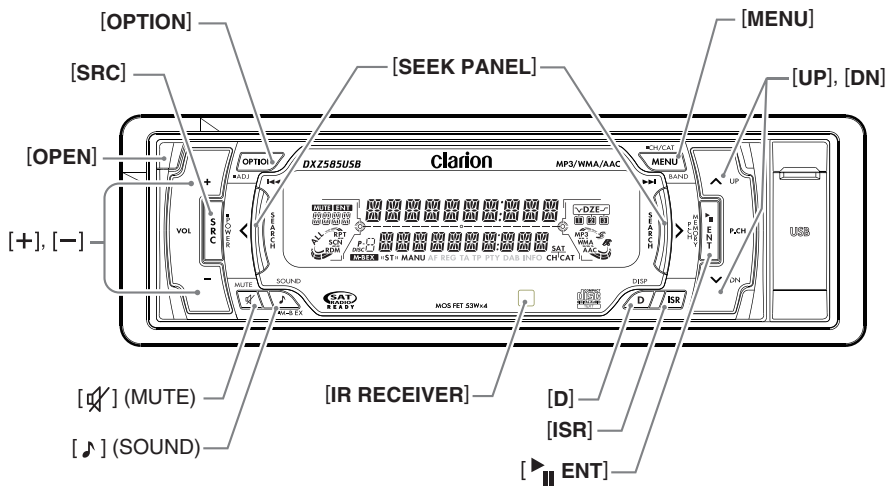

## With the FLIP DOWN PANEL opened

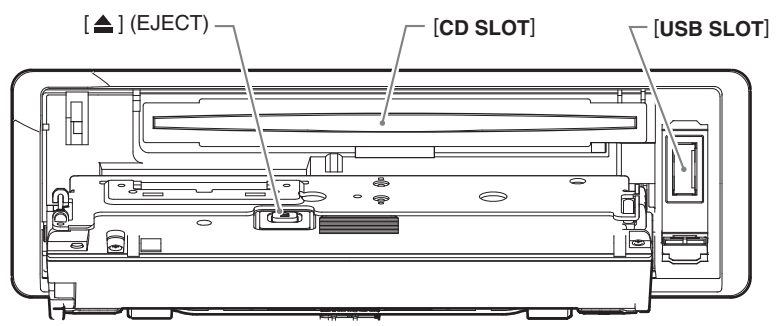

# Names of the Buttons and Their Functions

## [OPEN] button

- Deeply push in [OPEN] button to unlock the flip down panel.

## [SRC] button

- Press the button to turn on the power.
- Press and hold the button for 1 second or longer to turn off the power.
- Switch the operation mode among the radio mode, etc.

## [OPTION] button

- Press the button to enter the option mode.
- Press and hold the button for 1 second or longer to enter the adjust mode.

## [SEEK PANEL]

- The [SEEK PANEL] allows the controls on the ends to be moved to right or left to permit station tuning (radio), track selection (CD), and to perform various settings in the adjustment mode.

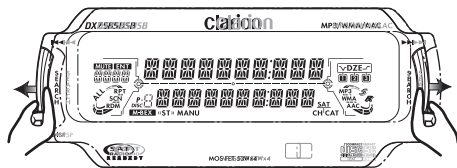

## [MENU] button

- Switch the band, or seek tuning or manual tuning while in the radio mode.
- Press the button to enter the list search mode while in the CD/MP3/WMA/AAC mode.
- Press and hold the button for 1 second or longer to play the first track while in the CD/MP3/WMA/AAC mode.
- Press the button to change the character.

## [▶||] button

- Play or pause a track while in the CD/MP3/WMA/AAC mode.
- Press the button to enter the preset memory mode (radio).
- Confirm various settings.

## [UP], [DN] buttons

- Press the button upward or downward to recall the stored station while in the radio mode.
- Select the folder while in the MP3/WMA/AAC mode.
- Perform various settings.

## [♪] (SOUND) button

- Press the button to enter the sound adjust mode.
- Press and hold the button for 1 second or longer to turn on or off the MAGNA BASS EXTEND mode.

## [ISR] button

- Recall ISR radio station in memory.
- Press and hold the button for 2 seconds or longer: Store current station into ISR memory (radio mode only).

## [IR RECEIVER]

- Receiver for remote control unit. (Operating range: 30° in all directions)

## [D] button

- Use the button to switch the user titles or track titles, etc. while in the CD/MP3/WMA/AAC mode.
- Press the button to switch the display indication (Main display, Title display and Clock time display).

## [M] (MUTE) button

- Turn mute on or off.

## [EJECT] button

- Press to eject a CD loaded in the unit.

## [+], [-] buttons

- Press the button upward or downward to adjust the volume.

## [CD SLOT]

- CD insertion slot.

## [USB SLOT]

- USB memory/MTP/iPod devices insertion slot.

# Display Items

Operation status indication  
Source, Titles, function, Setting,  
Clock, etc. are displayed

Operation status indication  
Titles, frequency, band, channel,  
play time, etc. are displayed

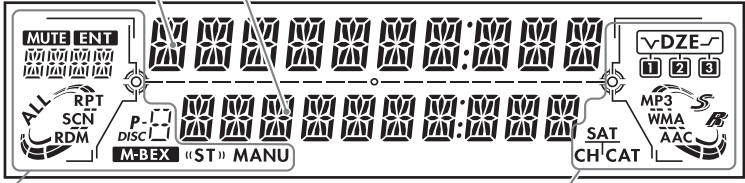

- MUTE** : MUTE indication
- ENT** : Enter indication
- : Source indication  
CD, USB etc. are displayed
- ALL** : Disc or Folder indication
- RPT** : Repeat indication
- SCN** : Scan indication
- RDM** : Random indication
- : Disc number indication  
Preset channel indication (1 to 6)
- M-BEX** : MAGNA BASS EX indication
- ST** : Stereo indication (radio only)
- MANU** : Manual indication

- : Digital Z-Enhancer indication
- MP3** : MP3 indication
- WMA** : WMA indication
- AAC** : AAC indication
- SR** : Sound Restorer indication
- SAT** : Satellite indication
- CH** : Channel indication
- CAT** : Category indication

# Display Screen

In extreme cold, the screen movement may slow down and the screen may darken, but this is normal. The screen will recover when it returns to normal temperature.



# 4. DCP (DETACHABLE CONTROL PANEL)

The control panel can be detached to prevent theft. When detaching the control panel, store it in the DCP (DETACHABLE CONTROL PANEL) case to prevent scratches.

We recommend taking the DCP with you when leaving the car.

## Removing the DCP

1. Press the [SRC] button for 1 second or longer to turn off the power.
2. Deeply push in [OPEN] button to unlock the flip down panel.
  - \* If the flip down panel does not open fully, gently open it with your hand.

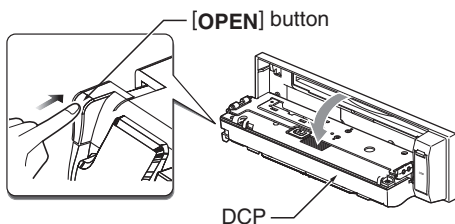

3. Pull the DCP toward you and remove it.

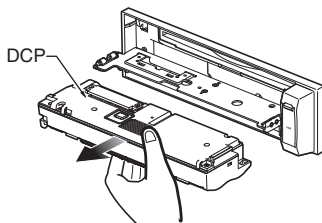

4. Close the HOLD FLAP.

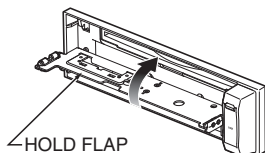

## CAUTION

Be sure to close the HOLD FLAP for safety when removing the DCP.

## Attaching the DCP

1. Insert the right side of the DCP into the main unit.
2. Insert the left side of the DCP into the main unit.

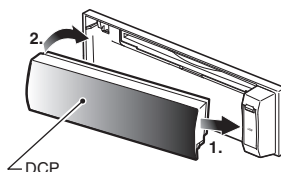

## CAUTION

- The DCP can easily be damaged by shocks. After removing it, be careful not to drop it or subject it to strong shocks.
- If the FLIP DOWN PANEL is kept open, the DCP may drop due to vibration of the car. This results in damage to the DCP. So close the FLIP DOWN PANEL or remove the DCP to store into the case.
- The connector connecting the source unit and the DCP is an extremely important part. Be careful not to damage it by pressing on it with fingernails, screwdrivers, etc.

### Note:

- If the DCP is dirty, wipe off the dirt with a soft, dry cloth only.

# 5. REMOTE CONTROL

## Inserting the Battery

- ① Turn over the remote control unit and slide the cover in the direction indicated by the arrow in the illustration.
- ② Insert the battery (CR2025) into the insertion guides, with the printed side (+) facing upwards.
- ③ Press the battery in the direction indicated by the arrow so that it slides into the compartment.
- ④ Replace the cover and slide in until it clicks into place.

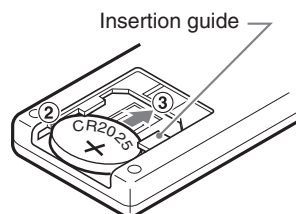
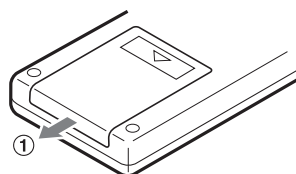

### Notes:

Misuse may result in rupture of the battery, producing leakage of fluid and resulting in personal injury or damage to surrounding materials. Always follow these safety precautions:

- Use only the designated battery.
- When replacing the battery, insert properly, with +/- polarities oriented correctly.
- Do not subject battery to heat, or dispose of in fire or water. Do not attempt to disassemble the battery.
- Dispose of used batteries properly.

# Functions of Remote Control Unit Buttons

\* Some buttons on the remote control unit have different functions from the corresponding buttons on the main unit.

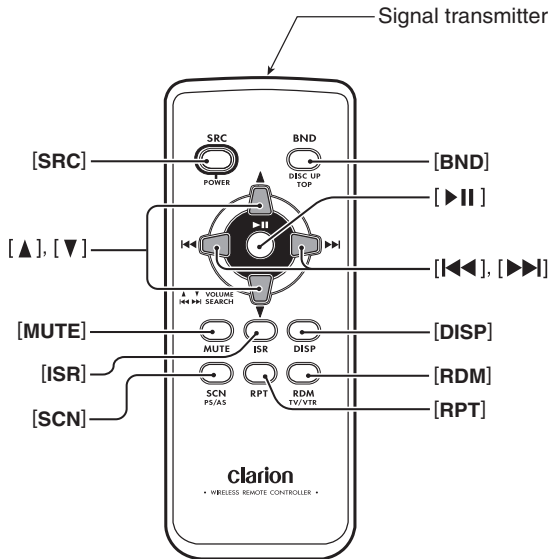

## ● Shared modes

### [SRC] button

- Press the button to turn on the power.  
Press and hold the button for 1 second or longer to turn off the power.
- Use to alternate operation mode among the various modes.

### [▲], [▼] buttons

- Increases and decreases volume.

### [MUTE] button

- Turns mute function on and off.

### [ISR] button

- Recalls ISR radio station stored in memory.
- Press and hold the button for 2 seconds or longer to store current station in ISR memory (radio mode only).

### [DISP] button

- Press to select the desired display.

## ● Radio/Satellite Radio modes

### [BND] button

- Switches reception band.

### [◀◀], [▶▶] buttons

- Moves preset channels up and down.

### [SCN] button

- Press to perform preset scan.
- Press and hold the button for 2 seconds or longer to perform auto store.
- In the Satellite Radio mode, press once to perform category scan; hold depressed for 1 second or longer to perform preset scan.

## ● CD/MP3/WMA/AAC and USB/MTP modes

### [BND] button

- Press to play the first track.

### [◀◀], [▶▶] buttons

- Press to move the tracks up and down.
- Press and hold the button for 1 second or longer to perform fast-forward/fast-backward (Except DRM file).

## Functions of Remote Control Unit Buttons

### [▶||] button

- Switches between playback and pause.

### [SCN] button

- Press to perform scan play.
- When in MP3/WMA/AAC and USB/MTP modes, press and hold the button for 1 second or longer to perform folder scan play.

### [RPT] button

- Press to perform repeat play.
- When in MP3/WMA/AAC and USB/MTP modes, press and hold the button for 1 second or longer to perform folder repeat play.

### [RDM] button

- Press to perform random play.
- When in MP3/WMA/AAC and USB/MTP modes, press and hold the button for 1 second or longer to perform folder random play.

## ● *CD changer/DVD changer modes*

### [BND] button

- Press to switch to next disc in ascending order.

### [◀◀], [▶▶] buttons

- Press to move to the tracks up and down.
- Press and hold the button for 1 second or longer to perform fast-forward/fast-backward.

### [▶||] button

- Switches between playback and pause.

### [SCN] button

- Press to perform scan play.
- Press and hold the button for 1 second or longer to perform disc scan play.

### [RPT] button

- Press to perform repeat play.
- Press and hold the button for 1 second or longer to perform disc repeat play.

### [RDM] button

- Press to perform random play.
- Press and hold the button for 1 second or longer to perform disc random play.

## ● *iPod mode*

### [◀◀], [▶▶] buttons

- Press to move the tracks up and down.
- Press and hold the button for 1 second or longer to perform fast-forward/fast-backward.

### [▶||] button

- Switches between playback and pause.

### [RPT] button

- Press to perform repeat play.

### [RDM] button

- Press to perform random play.
- Press and hold the button for 1 second or longer to perform all random play.

## ● *TV mode*

### [BND] button

- Switches reception band.

### [◀◀], [▶▶] buttons

- Moves preset channels up and down.

### [SCN] button

- Press to perform preset scan.
- Press and hold the button for 2 seconds or longer to perform auto store.

### [RDM] button

- Press to alternate between TV and VTR.

# 6. OPERATIONS

## Note:

- Be sure to read this chapter referring to the front diagrams of chapter "3. CONTROLS" on page 6.

## Basic Operations

### ⚠ CAUTION

Be sure to lower the volume before switching off the unit power or the ignition key. The unit remembers its last volume setting. If you switch the power off with the volume up, when you switch the power back on, the sudden loud volume may hurt your hearing and damage the unit.

### Turning on/off the power

#### Note:

- Be careful about using this unit for a long time without running the engine. If you drain the car's battery too far, you may not be able to start the engine and this can reduce the service life of the battery.

1. Press the [SRC] button.  
The mode that was previous active is displayed.
2. Press and hold the [SRC] button for 1 second or longer to turn off the power for the unit.

#### Note:

- The first time this unit is turned on after the wire connections are completed, it must be checked what equipment is connected. When the power is turned on, the "SYSTEM CHECK" appears in the display, then the unit returns to the clock display mode. The system check starts within the unit. When the system check is complete, press the [SRC] button again.

### Selecting a mode

1. Press the [SRC] button to change the operation mode.
2. Each time you press the [SRC] button, the operation mode changes in the following order:  
Radio → (Satellite radio) → CD/MP3/WMA/AAC → USB/MTP/iPod → (CD changer) → (DVD changer) → (TV) → AUX → Radio...  
\* External equipment not connected with CeNET is not displayed.  
\* iPod/MTP can connect to this unit via USB slot.

### Adjusting the volume

1. Press the [+] or [-] button to adjust the volume.  
\* The volume level is from 0 (minimum) to 33 (maximum).



### Switching the display

1. Press the [D] button to select the desired display.
- **When the power is turned off**
    1. Each time you press the [D] button, the clock time appears or disappears in the display.

## Basic Operations



### Adjusting MAGNA BASS EXTEND

The MAGNA BASS EXTEND does not adjust the low sound area like the normal sound adjustment function, but emphasizes the deep bass sound area to provide you with a dynamic sound.

1. Press and hold the [  ] button for 1 second or longer to turn on the MAGNA BASS EXTEND effect. "M-B EX" lights in the display.
2. Press and hold the [  ] button for 1 second or longer to turn off the MAGNA BASS EXTEND effect. "M-B EX" goes off from the display.
  - \* The adjustment can only be performed when the DZE is set to "DZE OFF".
  - \* The factory default setting is off.



### Mute

Use this function to turn off the sound immediately.

1. Press the [  ] button.  
The sound turns off and "MUTE" blinks in the display.
2. Press the [  ] button again to cancel the mute mode.

## Adjusting Sound Mode

### To change sound mode

1. Press the [  ] button and select the sound mode to adjust.
2. Push the [SEEK PANEL] leftward or rightward to select the "item name".  
"S-W VOL" ↔ "DZE" ↔ "BASS" ↔  
"TREBLE" ↔ "S RESTOR" ↔ "HPF" ↔  
"S-W LPF" ↔ "BALANCE" ↔ "FADER"
3. Press the [UP] or [DN] button to select the "desired setting value".
  - \* In the case of display blinking "ENT", you can press the [  ENT ] button to adjust the setting value.
  - \* "BASS" and "TREBLE" can be adjusted only when "DZE" is set to "DZE OFF" (page 15).
  - \* After completing settings, press the [  ] button to return to the previous mode.

#### Note:

- During sound adjustment mode, if no operation is performed for more than 10 seconds, this mode can be canceled and return to the previous mode.

### ● Adjusting the subwoofer output volume

You can adjust the volume output from the unit's subwoofer output terminal.

- 2-1. Select the "S-W VOL".
- 3-1. Press the [UP] or [DN] button to change the output volume.
  - \* The factory default setting is "0".  
(Setting range: +5 to -5)

## ● Setting the Digital Z-Enhancer

This unit is provided with 3 types of sound tone effects stored in memory. Select the one you prefer.

\* The factory default setting is "DZE OFF".

2-1. Select the "DZE".

3-1. Press the [UP] or [DN] button to select the tone effect. Each time you press the [UP] or [DN] button, the tone effect changes in the following order:

"DZE OFF" ↔ "DZE 1" ↔ "DZE 2" ↔ "DZE 3"

**DZE OFF** : No sound effect

**DZE 1** : Suitable for genuine speakers

**DZE 2** : Suitable for separate speakers

**DZE 3** : Suitable for co-axial speakers

3-2. When the "DZE 1", "DZE 2" or "DZE 3" is set, press the [ENT] button. Then press the [UP] or [DN] button to change the DZE level from +3 to -3.

\* The factory default setting is "0".

3-3. Press the [ENT] button to return to the previous mode.

## ● Compensation

There is no need to compensate frequency characteristics if they are flat (no peaks or valleys) when you have measured the frequency characteristics with a measuring device. However, sometimes the frequency characteristics rise or fall in some places. If this happens, the frequency characteristics must be compensated. Create a frequency curve having characteristics that are opposite to the center frequency of parts where the characteristics rise and fall to cancel out these peaks and values, and make the frequency characteristics as flat as possible.

Making the frequency characteristics as flat as possible is called "Compensation".

## ● Compensation of frequency characteristics

The figure below shows the relationship between the center frequency, gain and Q curve.

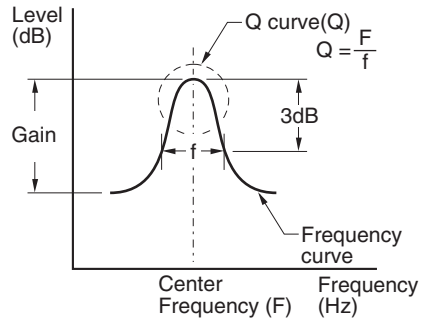

## ● Q curve

The Q curve becomes sharper when the numerical value is increased, and smoother when the numerical value is decreased.

Flat frequency characteristics can be made by selecting a Q curve opposite to that of the curve to be compensated.

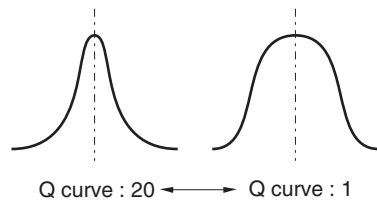

## ● Adjusting the bass

The bass gain, bass FREQ (center frequency) and bass Q can be adjusted as follows.

The adjustment can only be performed when the DZE is set to "DZE OFF".

2-1. Select "BASS".

2-2. Press the [ENT] button.

2-3. Push the [SEEK PANEL] leftward or rightward and select from:

"B GAIN" ↔ "B FREQ" ↔ "B Q"

3-1. Press the [UP] or [DN] button to adjust the gain, the FREQ (center frequency) and the Q.

**B GAIN**: -7 to 7 (The factory default setting is "0")

**B FREQ**: 50Hz/80Hz/120Hz (The factory default setting is "50")

**B Q**: 1/1.25/1.5/2 (The factory default setting is "1")

3-2. Press the [ENT] button to return to the previous mode.

## Basic Operations

### ● Adjusting the treble

The treble gain and treble FREQ (center frequency) can be adjusted as follows.

The adjustment can only be performed when the DZE is set to "DZE OFF".

2-1. Select "TREBLE".

2-2. Press the [  ENT ] button.

2-3. Push the [SEEK PANEL] leftward or rightward and select from:

"T GAIN" ↔ "T FREQ"

3-1. Press the [UP] or [DN] button to adjust the gain and FREQ (center frequency).

**T GAIN:** -6 to +6 (The factory default setting is "0")

**T FREQ:** 8KHz/12KHz (The factory default setting is "12K")

3-2. Press the [  ENT ] button to return to the previous mode.

### ● Adjusting the sound restorer

The sound restorer enriches the playback of all types of music files that have undergone any level of data compression.

2-1. Select "S RESTOR".

3-1. Press the [UP] or [DN] button to adjust.

Each time you press the [UP] or [DN] button, the sound restorer changes in the following order:

"OFF" ↔ "1" ↔ "2" ↔ "3"

\* The factory default setting is "OFF".

Set this adjustment in accordance with the music source used.

**OFF:** For music sources compressed at high bit rate

**1:** For music sources compressed for high quality at low bit rate

**2:** For music sources compressed for standard quality at low bit rate

**3:** For music sources compressed for low quality at low bit rate

### ● Setting high pass filter

2-1. Select "HPF".

3-1. Press the [UP] or [DN] button to select the setting. Each time you press the [UP] or [DN] button, the setting changes in the following order:

"THROUGH" ↔ "50Hz" ↔ "80Hz" ↔ "120Hz"

\* The factory default setting is "THROUGH" (through).

### ● Setting low pass filter

2-1. Select "S-W LPF".

3-1. Press the [UP] or [DN] button to select the setting.

Each time you press the [UP] or [DN] button, the setting changes in the following order:

"THROUGH" ↔ "50Hz" ↔ "80Hz" ↔ "120Hz"

\* The factory default setting is "THROUGH" (through).

### ● Adjusting the balance

2-1. Select "BALANCE".

3-1. Press the [UP] button to emphasize the sound from the right speaker, press the [DN] button to emphasize the sound from the left speaker.

\* The factory default setting is "CENTER". (Adjustment range: L12 to R12)

### ● Adjusting the fader

2-1. Select "FADER".

3-1. Press the [UP] button to emphasize the sound from the front speaker, press the [DN] button to emphasize the sound from the rear speaker.

\* The factory default setting is "CENTER". (Adjustment range: R12 to F12)



## Listening to the radio

1. Press the [SRC] button and select the radio mode. The frequency appears in the display.
2. Press the [MENU] button and select the radio band. Each time the button is pressed, the radio reception band changes in the following order:  
FM1 → FM2 → FM3 → AM → FM1...
3. Push the [SEEK PANEL] leftward or rightward to tune in the desired station.

## Tuning

There are 3 types of tuning mode available, seek tuning, manual tuning and preset tuning.

## Seek tuning

1. Press the [MENU] button and select the desired band (FM or AM).
2. Tune into a station.
  - \* If "MANU" is lit in the display, press and hold the [MENU] button for 1 second or longer. "MANU" in the display goes off and seek tuning is now available.

When the [SEEK PANEL] is pushed rightward, the station is sought in the direction of higher frequencies; if the [SEEK PANEL] is pushed leftward, the station is sought in the direction of lower frequencies.

## Manual tuning

There are 2 ways available: Quick tuning and step tuning.

When you are in the step tuning mode, the frequency changes one step at a time. In the quick tuning mode, you can quickly tune the desired frequency.

1. Press the [MENU] button and select the desired band (FM or AM).
  - \* If "MANU" is not lit in the display, press and hold the [MENU] button for 1 second or longer. "MANU" is lit in the display and manual tuning is now available.
2. Tune into a station.

## ● Quick tuning

Push the [SEEK PANEL] leftward or rightward and hold in position for 1 second or longer to tune in a station.

## ● Step tuning



Push the [SEEK PANEL] leftward or rightward to manually tune in a station.

## Recalling a preset station

A total of 24 preset positions (6-FM1, 6-FM2, 6-FM3, 6-AM) exists to store individual radio stations in memory. Pressing the [UP] or [DN] button recalls the stored radio frequency automatically.

1. Press the [MENU] button and select the desired band (FM or AM).
2. Press the [UP] or [DN] button to recall the stored station.

## Manual memory

1. Select the desired station with seek tuning or manual tuning.
2. Press the [  ENT ] button to enter the preset memory mode.
3. Press the [UP] or [DN] button to select a desired station, then press and hold the [  ENT ] button for 2 seconds or longer to store the current station into preset memory.

## Radio Operations

### Auto store

Auto store is a function for storing up to 6 stations that are automatically tuned in sequentially. If 6 receivable stations cannot be received, a previously stored station remains unoverwritten at the memory position.

1. Press the [MENU] button and select the desired band (FM or AM).
2. Press the [OPTION] button.
3. Push the [SEEK PANEL] leftward or rightward to select "AUTO STORE".
4. Press and hold the [▶|| ENT] button for 2 seconds or longer. The stations with good reception are stored automatically to the preset channels.

### Preset scan

Preset scan receives the stations stored in preset memory in order. This function is useful when searching for a desired station in memory.

1. Press the [OPTION] button.
2. Push the [SEEK PANEL] leftward or rightward to select "PRESET SCN".
3. Press the [▶|| ENT] button.
  - \* When a desired station is tuned in, press the [▶|| ENT] button again to continue receiving that station.

### Instant station recall (ISR)

Instant station recall is a special radio preset that instantly accesses a favorite radio station at a touch of a button. The ISR function even operates with the unit in other modes.

#### ● ISR memory

1. Select the station that you wish to store in ISR memory.
2. Press and hold the [ISR] button for 2 seconds or longer.

#### ● Recalling a station with ISR

In any mode, press the [ISR] button to turn on the radio function and tune the selected radio station. "ISR" appears in the display. Press the [ISR] button again to return to the previous mode.

## MP3/WMA/AAC

### What is MP3?

MP3 is an audio compression method and classified into audio layer 3 of MPEG standards. This audio compression method has penetrated into PC users and become a standard format.

This MP3 features the original audio data compression to about 10 percent of its initial size with a high sound quality. This means that about 10 music CDs can be recorded on a CD-R disc or CD-RW disc to allow a long listening time without having to change CDs.

### What is WMA?

WMA is the abbreviation of Windows Media Audio, an audio file format developed by Microsoft Corporation.

#### Notes:

- If you play a file with DRM (Digital Rights Management) for WMA remaining ON, no audio is output (The WMA indicator blinks).
- Windows Media™, and the Windows® logo are trademarks, or registered trademarks of Microsoft Corporation in the United States and/or other countries.

#### ● To disable DRM (Digital Rights Management)

1. When using Windows Media Player 9/10/11, click on TOOL → OPTIONS → MUSIC RECORD tab, then under Recording settings, unclick the Check box for RECORD PROTECTED MUSIC. Then, reconstruct files.

Personally constructed WMA files are used at your own responsibility.

### What is AAC?

- AAC is an acronym for “Advanced Audio Coding” and refers to the audio compression method used with video compression standards MPEG-2 and MPEG-4.
- AAC files composed with the following conditions can be played:
  - AAC files encoded with iTunes.
  - iTunes Ver. 7.0 or earlier.
  - File extension “.m4a” (“.M4A”)
- Tracks purchased at an iTunes Music store, and copyright-protected files cannot be played.

- When playing AAC files that include image data, additional time may be required before playback begins.
- Files may not play properly, depending on the iTunes version under which an AAC file is encoded.

### Precautions when creating MP3/WMA/AAC file

#### ● Usable sampling rates and bit rates

1. MP3: Sampling rate 8 kHz–48 kHz,  
Bit rate 8 kbps–320 kbps / VBR
2. WMA: Bit rate 8 kbps–320 kbps
3. AAC: Sampling rate 8 kHz–48 kHz,  
Bit rate 8 kbps–320 kbps / VBR

#### ● File extensions

1. Always add a file extension “.MP3” (.mp3), “.WMA” (.wma) or “.M4A” (.m4a) to MP3, WMA or AAC file by using single byte letters. If you add a file extension other than specified or forget to add the file extension, the file cannot be played.
2. Files without MP3/WMA/AAC data will not play. The files will be played soundlessly if you attempt to play files without MP3/WMA/AAC data.

\* When VBR files are played, the play time display may differ the play location.

\* When MP3/WMA/AAC files are played, a little no sound part is caused between tunes.

#### ● Logical format (File system)

1. When writing MP3/WMA/AAC file on a CD-R disc or CD-RW disc, please select “ISO9660 level 1, 2 or JOLIET or Romeo or APPLE ISO” as the writing software format. Normal play may not be possible if the disc is recorded on another format.
2. The folder name and file name can be displayed as the title during MP3/WMA/AAC play but the title must be within 64 single byte alphabetical letters and numerals (including an extension).
3. Do not affix a name to a file inside a folder having the same name.

#### ● Folder structure

1. A disc with a folder having more than 8 hierarchical levels will be impossible.

## CD/MP3/WMA/AAC Operations

### ● Number of files or folders

1. Up to 255 files can be recognized per folder.  
Up to 510 files can be played.
2. Tracks are played in the order that they were recorded onto a disc. (Tracks might not always be played in the order displayed on the PC.)
3. Some noise may occur depending on the type of encoder software used while recording.

### Set the type of file to be played (multi-session function)

When a single disc holds both normal CD type tracks and MP3/WMA/AAC type tracks, use this command to select which type of track to play.

\* Default setting is "CD".

- When only one type of track (either music CD or MP3/WMA/AAC) is recorded on a disc, selecting either type will allow playback of the disc.
- When playing CCCD (copy-control CDs), set to CD type.
  1. Press the [OPTION] button.
  2. Push the [SEEK PANEL] leftward or rightward to select "M-SESS".
  3. Press the [UP] or [DN] button to select "CD" or "MP3". The mixed mode is switched between CD type or MP3/WMA/AAC type.
    - **CD**  
When playing music CD only.
    - **MP3**  
When playing music MP3/WMA/AAC only.
- 4. When setting is completed, remove the disc and reinsert it.

### Disc-In-Play function

As long as the ignition key is turned to the ON or ACC position, this function allows you to turn the power to the unit and start playing the disc automatically when the disc is inserted even if the power is not turned on.

## ⚠ CAUTION

- Do not try to put your hand or fingers in the disc insertion slot. Also never insert foreign objects into the slot.
- Do not insert discs where adhesive comes out from cellophane tape or a rental CD label, or discs with marks where cellophane tape or rental CD labels were removed. It may be impossible to extract these discs from the unit and they may cause the unit to break down.

### Backup Eject function

Just pressing the [▲] button, ejects the disc even if the power to the unit was not turned on.

1. Press the [OPEN] button to open the FLIP DOWN PANEL.

#### Note:

- If the FLIP DOWN PANEL will not open far enough, open it gently with your hand.
2. Press the [▲] button. Remove the disc after it is ejected.
  3. Close the FLIP DOWN PANEL.
    - \* Press the center of the DCP to close.

#### Notes:

- Always close the FLIP DOWN PANEL once you take out the disc.
- If you force a CD into before auto reloading, this can damage the CD.
- If a CD (12 cm) is left in the ejected position for 15 seconds, the CD is automatically reloaded (Auto reload).

### Listening to a disc already loaded in the unit

Press the [SRC] button to select the CD/MP3/WMA/AAC mode.



When the unit enters the CD/MP3/WMA/AAC mode, play starts automatically.

If there is no disc loaded, the indication "NO DISC" appears in the title display.

## Loading a CD

1. Press the [OPEN] button to access the CD SLOT behind the FLIP DOWN PANEL.
2. Insert a CD into the center of the CD SLOT with the labeled side facing up. The CD plays automatically after loading.

### Notes:

- Never insert foreign objects into the CD SLOT.
  - If the CD is not inserted easily, there may be another CD in the mechanism or the unit may require service.
  - Discs not bearing the  or  mark and CD-ROMs cannot be played by this unit.
  - Some CDs recorded in CD-R/CD-RW mode may not be usable.
3. Close the FLIP DOWN PANEL.
    - \* Press the center of the DCP to close.



## CAUTION

Be careful not to catch your hand or fingers while closing the FLIP DOWN PANEL.

### Notes:

- If the FLIP DOWN PANEL does not open fully, gently open with your hand.
- After loading a CD, always close the FLIP DOWN PANEL.

## Pausing play

1. Press the [  ENT ] button to pause play. "PAUSE" appears in the display.
2. To resume CD play, press the [  ENT ] button again.

## Displaying CD titles

This unit can display title data for CD-text/MP3/WMA/AAC disc and user titles input with this unit.

1. Each time you press the [D] button, the title display changes in the following order:

### ● CD-TEXT disc

Track → Disc/Artist → User → Track ...

### ● MP3/WMA/AAC disc

Track → Folder → Title/Album → Artist → Track ...

### Notes:

- If the CD playing is not a CD-text CD or no user title has been input, "NO TITLE" appears in the display.
- If MP3/WMA/AAC disc is not input TAG, "NO TITLE" appears in the display.
- For MP3, supports ID3 Tags V2.3 / 2.2 / 1.1 / 1.0.
- Tag displays give priority to V2.3 / 2.2.
- In the case of album Tags for WMA, the information written into the extension header is displayed.
- Only ASCII characters can be displayed in Tags.

## Selecting a track

### ● Track-up

1. Push the [SEEK PANEL] rightward to move ahead to the beginning of the next track.
2. Each time you push the [SEEK PANEL] rightward, the track advances ahead to the beginning of the next track.

### ● Track-down

1. Push the [SEEK PANEL] leftward to move back to the beginning of the current track.
2. Push the [SEEK PANEL] leftward twice to move back to the beginning of the previous track.

## CD/MP3/WMA/AAC Operations

### Fast-forward/fast-backward

#### ● Fast-forward

1. Push the **[SEEK PANEL]** rightward and hold in position for 1 second or longer.

#### ● Fast-backward

1. Push the **[SEEK PANEL]** leftward and hold in position for 1 second or longer.
  - \* For MP3/WMA/AAC discs, it takes some time until the start of searching and between tracks. In addition, the playing time may have a margin of error.

### Folder Select

This function allows you to select a folder containing MP3/WMA/AAC files and start playing from the first track in the folder.

1. Press the **[UP]** or **[DN]** button.
 

Press the **[UP]** button to move the next folder. Press the **[DN]** button to move the previous folder.

  - \* Folder without an MP3/WMA/AAC file is not selectable.
2. To select a track, push the **[SEEK PANEL]** leftward or rightward.

### Top function

The top function resets the CD player to the first track of the disc. Press and hold the **[MENU]** button for 1 second or longer to play the first track (track No. 1) on the disc.

- \* In case of MP3/WMA/AAC, the first track of a folder being played will be returned.

### List search function

1. Press the **[MENU]** button to enter the list search mode. And then the track list appears in the display.
2. Press the **[UP]** or **[DN]** button to select a track.
  - \* If you push the **[SEEK PANEL]** leftward or rightward, the track list scrolls 5 lines at a time.
3. Press the **[▶||ENT]** button to play.
  - \* In case of MP3/WMA/AAC, this function is performed in the current folder.
  - \* If no operation is performed for more than 10 seconds, this mode can be cancel and return to the usual mode.

## Other various play functions

1. Press the [OPTION] button.



### ● Scan play

This function allows you to locate and play the first 10 seconds of all the tracks recorded on a disc.

2. Push the [SEEK PANEL] leftward or rightward to select "SCN".
3. Press the [UP] or [DN] button to select "TRACK", and then press the [▶|| ENT] button to perform scan play. "SCAN" appears in the display.
  - \* Scan play starts from the next track after the track currently being played.

### ● Folder scan play

This function allows you to locate and play the first 10 seconds of the first track of all the folders on an MP3/WMA/AAC disc.

2. Push the [SEEK PANEL] leftward or rightward to select "SCN".
3. Press the [UP] or [DN] button to select "ALL", and then press the [▶|| ENT] button to perform folder scan play. "ALL SCN" appears in the display.
  - \* Folder scan play starts from the next folder after the folder currently being played.

### ● Repeat play

This function allows you to play the current track repeatedly.

2. Push the [SEEK PANEL] leftward or rightward to select "RPT".
3. Press the [UP] or [DN] button to select "TRACK", and then press the [▶|| ENT] button to perform repeat play.
  - \* "REPEAT" appears in the display.

### ● Folder repeat play

This function allows you to play a track currently being played in the MP3/WMA/AAC folder repeatedly.

2. Push the [SEEK PANEL] leftward or rightward to select "RPT".
3. Press the [UP] or [DN] button to select "ALL", and then press the [▶|| ENT] button to perform folder repeat play. "ALL RPT" appears in the display.

### ● Random play

This function allows you to play all tracks recorded on a disc in a random order.

2. Push the [SEEK PANEL] leftward or rightward to select "RDM".
3. Press the [UP] or [DN] button to select "TRACK", and then press the [▶|| ENT] button to perform random play. "RANDOM" appears in the display.

### ● Folder random play

This function allows you to play all the tracks of all the folders recorded on an MP3/WMA/AAC disc in a random order.

2. Push the [SEEK PANEL] leftward or rightward to select "RDM".
3. Press the [UP] or [DN] button to select "ALL", and then press the [▶|| ENT] button to perform folder random play. "ALL RDM" appears in the display.

### ● To cancel the trick play

2. Push the [SEEK PANEL] leftward or rightward to select "TRICK PLAY OFF".
3. Press the [▶|| ENT] button to cancel the trick play.

# Operations Common to Each Mode

## To change adjustment setting

1. Press and hold the [OPTION] button for 1 second or longer to switch to the adjustment selection display.
2. Push the [SEEK PANEL] leftward or rightward to select the "item name".  
 "CLOCK" ↔ "CONTRAST" ↔ "SCRN SVR" ↔ "MESSAGE INPUT" ↔ "AUTO SCR" ↔ "SCRL SPD" ↔ "DIMMER" ↔ "BLINKLED" ↔ "A CANCEL" ↔ "TEL SP" ↔ "TEL SW" ↔ "SYSTEM CHECK" ↔ "CLOCK"...
3. Press the [UP] or [DN] button to select the "desired setting value".
  - \* In the case of display blinking "ENT", you can press the [▶|| ENT] button to adjust the setting value.
  - \* After completing settings, press the [OPTION] button to return to the previous mode.

## ● Setting the clock

- 2-1. Select "CLOCK".
- 3-1. Press the [▶|| ENT] button
- 3-2. Push the [SEEK PANEL] leftward or rightward to select the hour or the minute.
- 3-3. Press the [UP] or [DN] button to set the correct time.
  - \* The clock is displayed in 12-hour format.
- 3-4. Press the [▶|| ENT] button to store the time into memory.

### Note:

- You cannot set the clock when it is displayed with only the ignition on. If you drain or remove the car's battery or take out this unit, the clock is reset. While setting the clock, if another button or operation is selected, the clock set mode is canceled.

## ● Setting the contrast

You can adjust the display contrast to match the angle of installation of the unit.

- \* The factory default setting is "7". (Adjustment level: 1 to 16)

- 2-1. Select "CONTRAST".
- 3-1. Press the [UP] or [DN] button to adjust the contrast.

## ● Turning the screen saver function on or off

This unit is provided with the screen saver function which allows you to show various kinds of patterns and characters in the operation status indication area of the display in a random order. You can turn on or off this function. If the button operation is performed with the screen saver function on, the operation display corresponding to the button operation is shown for about 30 seconds and the display returns to the screen saver display.

- \* The factory default setting is "ON".

- 2-1. Select "SCRN SVR".

- 3-1. Press the [UP] or [DN] button to select "ON" or "OFF".

## ● Entering message information

Message up to 30 characters long can be stored in memory and displayed as a type of screen saver setting.

- \* The factory default setting is "WELCOME TO CLARION".

- 2-1. Select "MESSAGE INPUT".

- 3-1. Press the [▶|| ENT] button.

- 3-2. Press and hold the [MENU] button for 1 second or longer to clear the old message.

- 3-3. Push the [SEEK PANEL] leftward or rightward to move the cursor.

- 3-4. Press the [MENU] button to select a character type. Each time you press the [MENU] button, the character type changes in the following order:

Capital letters → Numbers → Symbols → Capital letters...

- 3-5. Press the [UP] or [DN] button to select the desired character.

- 3-6. Repeat step 3-3 to 3-5 to enter up to 30 characters for message.

- 3-7. Press and hold the [▶|| ENT] button for 2 seconds or longer to store the message in memory and return to the previous mode.

- \* Press and hold the [MENU] button for 1 second or longer to cancel the input message. Then press and hold the [▶|| ENT] button for 2 seconds or longer to store the message and the message return to the default setting.



### ● Setting the method for title scroll

Set how to scroll in CD-TEXT, MP3/WMA/AAC title.

\* The factory default setting is "ON".

2-1. Select "AUTO SCR".

3-1. Press the [UP] or [DN] button to select "ON" or "OFF".

• **ON:**

To scroll automatically.

• **OFF:**

To scroll just 1 time.

\* When you want to see the title again, in the title mode, press and hold the [D] button for 1 second or longer to scroll the title.

### ● Setting the speed of the title scroll

This function allows you to adjust the speed of the title scroll.

\* The factory default setting is "SPEED3".

2-1. Select "SCRL SPD".

3-1. Press the [UP] or [DN] button to select from "SPEED1" to "SPEED6".

### ● Setting the dimmer control

You can set the dimmer control "HIGH", "MID", "LOW" or "OFF".

\* The factory default setting is "MID".

2-1. Select "DIMMER".

3-1. Press the [UP] or [DN] button to select "HIGH", "MID", "LOW" or "OFF".

### ● Anti-theft indicator

The red Anti-theft indicator is a function for preventing theft. When the DCP is removed from the unit, this indicator blinks.

\* The factory default setting is "OFF".

2-1. Select "BLINKLED".

3-1. Press the [UP] or [DN] button to select "ON" or "OFF".

### ● Setting the external amplifier

\* The factory default setting is "OFF".

2-1. Select "A CANCEL".

3-1. Press the [UP] or [DN] button to select "ON" or "OFF".

• **ON:**

Use with connected AMP.

• **OFF:**

Use with inside AMP.

### ● Setting the car speaker output for the cellular phone

When the AUX input cable is used to connect a AUX BLUETOOTH BB (BLT370) (sold separately).

\* The factory default setting is "R".

\* To output the telephone calls, set the cellular phone interrupt to ON.

2-1. Select "TEL SP".

3-1. Press the [UP] or [DN] button to select "R" or "L".

• **R:**

Telephone calls can be heard on the front right speaker connected to this unit.

• **L:**

Telephone calls can be heard on the front left speaker connected to this unit.

### ● Cellular phone interrupt setting

If you connect this unit and your cellular phone with a separately sold cable, you can listen to your telephone calls on your car speakers.

When the AUX input cable is used to connect a AUX BLUETOOTH BB (BLT370) (sold separately).

\* The factory default setting is "OFF".

2-1. Select "TEL SW".

3-1. Press the [UP] or [DN] button to select the setting in the following order:

"OFF" ↔ "ON" ↔ "MUTE"

• **OFF:**

This unit continues normal operation even when the cellular phone is used.

• **ON:**

You can listen to your telephone calls from the speakers connected to this unit.

\* When listening to your calls on your car speakers, you can adjust the volume by pressing the [UP] or [DN] button.

• **MUTE:**

The sound from this unit is muted during telephone calls.

**Note:**

• If connecting a hands-free kit, please ensure the setting is ON to receive the telephone audio through the system.

## Operations Common to Each Mode

### ● Performing a system check

2-1. Select "SYSTEM CHECK".

3-1. Press and hold the [  ENT ] button for 1 second or longer.

"SYSTEM CHECK" appears in the display, then the unit returns to the previous operation mode.

### AUX function

This system has an external input cable so you can listen to sounds and music from external devices connected to this unit.

#### ● Selecting AUX IN sensitivity

Make the following settings to select the sensitivity when sounds from external devices connected to this unit are difficult to hear even after adjusting the volume.

\* The factory default setting is "MID".

1. Press the [OPTION] button, "AUX SENS MID" appears in the display.
2. Press the [UP] or [DN] button to select "LOW", "MID" or "HIGH".
3. Press the [OPTION] button to return to the previous mode.

#### Note:

- When AUX mode is selected, AUX IN sensitivity can be set.



### Entering titles

Titles up to 10 characters long can be stored in memory and displayed for CD, CD changer and TV stations. The number of titles that can be entered for each mode are as follows.



Mode	Number of titles
Radio mode	30 titles
CD mode	50 titles
TV mode	20 titles

CD changer mode	Number of titles
DCZ625 connected	100 titles

1. Press the [SRC] button to select the mode you want to enter a title (CD, CD changer or TV).
2. Select and play a CD in the CD changer or tune in to a TV station for which you want to enter the title.
3. Press the [OPTION] button.
4. Push the [SEEK PANEL] leftward or rightward to select "TITLE INPUT".

5. Press the [  ENT ] button.  
The display switches to the title input display.
6. Push the [SEEK PANEL] leftward or rightward to move the cursor.
7. Press the [MENU] button to select a character type. Each time you press the [MENU] button, the character type changes in the following order:  
Capital letters → Numbers → Symbols → Capital letters...
8. Press the [UP] or [DN] button to select the desired character.
9. Repeat steps 6 to 8 to enter up to 10 characters for the title.
10. Press and hold the [  ENT ] button for 2 seconds or longer to store the title into memory.

### Clearing titles

1. Select and play a CD in the CD changer or tune in to a TV station for which you want to clear the title.
2. Press the [OPTION] button.
3. Push the [SEEK PANEL] leftward or rightward to select "TITLE INPUT".
4. Press the [  ENT ] button.  
The display switches to the title input display.
5. Press and hold the [MENU] button for 1 second or longer.  
All characters in the title disappear.
6. Press and hold the [  ENT ] button for 2 seconds or longer to store the setting.

# 7. ACCESSORIES

## USB/MTP Operations

### USB memory/MTP device operation

#### Note:

- The following operations are the same as for CD mode:

\*Pause

\*Track selection

\*Fast-forward/fast-backward (Except DRM file)

\*Top function

\*Scan play

\*Repeat play

\*Random play

\*Folder selection

\*List search function

See “CD/MP3/WMA/AAC Operations” (page 19-23) for details.

### About USB memory

- USB is an acronym for Universal Serial Bus, and refers to an external bus standard supporting data transfer rates of 12 Mbps.
- This unit is compatible with USB 1.1/2.0 with maximum data transfer rates of 12 Mbps.
- USB memory devices that can be played by connecting to the unit’s USB cable are limited to those recognized as “USB mass storage class devices”; operation is not guaranteed with all USB memory devices.
  - \* Devices compatible with “USB Mass Storage Class” can be used merely by connecting to the host device, without need for special drivers or application software.
- Consult the manufacturer of your USB memory device for information regarding whether it is supported by “USB Mass Storage Class” standards.
- Audio files playable on this unit are limited to MP3/WMA/AAC files. For details, see the section “MP3/WMA/AAC” (page 19).
- To prevent the accidental loss of data, always back up important data on your computer.
- This unit does not support connections to a computer. In addition, connections made through a USB hub device are also not supported.

- When a USB memory device is composed of two or more drives, only one of the drives will be detected.
- USB memory devices with security functions cannot be played.
- The order in which tracks are recorded may differ depending on the USB memory device connected (the actual playback order may not be the same as that indicated on your computer’s display).
- If you continuously operate folder up/down, the play time keeps as “00:00”, and the sound is not emitted.

### About USB Digital Media Streaming

This unit supports USB Digital Media Streaming. USB Digital Media Streaming is a function used to play music files transmitted using Media Transfer Protocol (MTP). This function also supports the playback of WMDRM 10 files.

During USB Digital Media Streaming, the unit displays the “MTP” mode indicator.

Use of USB Digital Media Streaming requires the purchase of a supported portable audio player. For information regarding supported portable audio players, consult your nearest Clarion dealer, or visit Clarion's website.

# USB/MTP Operations

## ⚠ CAUTION

- **Insert and remove a USB memory/MTP device only when the device is not being accessed. Connecting or disconnecting the device at the following times may result in the loss of data:**
  - If the USB memory/MTP device is removed or power is disconnected during writing to the device.
  - When the device is subjected to static electricity or electric noise.
- **Do not leave a USB memory/MTP device unattended in an automobile. Exposure to direct sunlight or high temperatures may cause deformation or other malfunction of the USB memory/MTP device.**
- **Do not turn on vehicle ignition when the MTP device is connected, since it may result in loss or damage to data on the MTP device.**  
**Connect the MTP device to the USB slot after vehicle ignition is turned on.**

### Connecting a USB memory/MTP device

1. Connect the USB memory/MTP device to the USB slot.  
 Playback will begin from the first file recorded on the device.

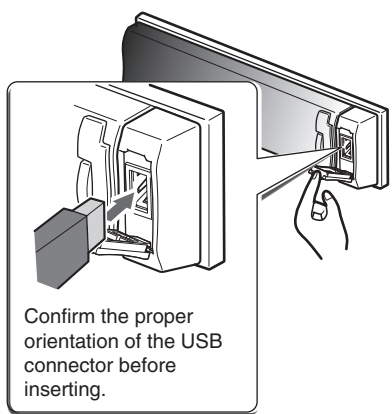

- \* If the device is not recognized, press the [SRC] button to switch the source to the device.
- \* Always insert the device fully into the connector. Incomplete connections may cause the device not to be recognized.
- \* Depending on the number of tracks recorded, some amount of time may be required until all tracks are read into the unit.
- \* The order in which tracks are recorded may differ depending on the device connected (the actual playback order may not be the same as that indicated on your computer's display).

### To listen to tracks on a connected USB memory/MTP device

1. Press the [SRC] button to switch the source. When USB memory/MTP device is selected, playback (except DRM files) will begin from the location at which playback was previously stopped.
  - \* When a USB memory/MTP device is connected the USB/MTP mode will be displayed.
  - \* When a USB memory/MTP device is disconnected and then reconnected, playback will begin from the beginning of the USB memory/MTP device.
  - \* When "MTP" mode is selected, AAC files on the MTP device cannot be played.

### To stop play

1. Press the [SRC] button and switch the function to a source other than the USB memory.

## ⚠ CAUTION

**Do not remove the USB memory/MTP device when the USB/MTP mode is selected, since it may result in loss or damage to data on the USB memory/MTP device.**  
**Always backup and save important data on your computer.**

2. Remove the USB memory/MTP device from the USB slot.

## ● iPod

This section describes operations when connected to an Apple iPod via the USB slot.

### Notes:

- See the iPod Owner's Manual for details regarding operation conditions.
- The unit will not operate, or may operate improperly with unsupported versions.
- For a list of compatible Apple iPod unit with the this model, please contact your Clarion dealer or [www.clarion.com](http://www.clarion.com).

## Connecting an iPod

When an iPod is connected to the USB slot, "Shuffle" set on the iPod will become as follows:

- "Shuffle (Albums)" play → Random play
- "Shuffle (Songs)" play → All random play

The iPod has two modes, the "Play mode" and the "iPod menu mode" for selecting tracks. Switch between these modes by pressing the [MENU] button.

### Note:

- To connect iPod, please use the USB cable attached in iPod.

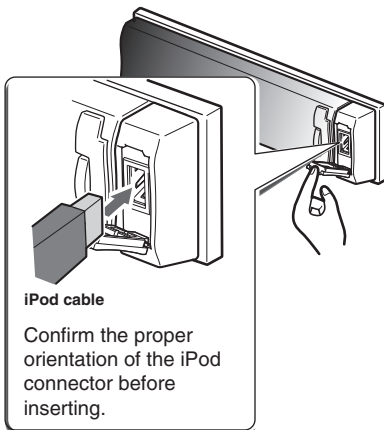

## Select iPod mode

1. Press the [SRC] button.  
Playback will begin from the last file that was played on the iPod.

### Note:

- The following operations in Play mode operate the same as in CD mode:
  - \*Track selection: [SEEK PANEL]
  - \*Fast-forward/fast-backward: [SEEK PANEL]
  - \*Pause: [▶|| ENT]See "CD/MP3/WMA/AAC Operations" (page 19-23) for details.

## Other various play functions (in Play mode)

### Notes:

- These functions are not supported when in the iPod menu mode.
- The Random function set on the iPod remains the same after attachment/ detachment of the iPod.
- The Repeat function on the iPod will be changed when you connect/disconnect the iPod to the unit.

1. Press the [OPTION] button.

### ● Repeat play

Play back one track repeatedly.

2. Push the [SEEK PANEL] leftward or rightward to select "RPT".
3. Press the [▶|| ENT] button to perform repeat play.

### ● Random play

Play all albums within a selected category, in random order. (Corresponds to "Shuffle (Albums)" command on iPod.)

2. Push the [SEEK PANEL] leftward or rightward to select "RDM".
3. Press the [UP] or [DN] button to select "ALBUM", and then press the [▶|| ENT] button to perform random play.

### ● All random play

Play all tracks within a selected category, in random order. (Corresponds to "Shuffle (Songs)" command on iPod.)

2. Push the [SEEK PANEL] leftward or rightward to select "RDM".
3. Press the [UP] or [DN] button to select "ALL", and then press the [▶|| ENT] button to perform all random play.

# iPod Operations

## ● To cancel the trick play

2. Push the [SEEK PANEL] leftward or rightward to select "RPT OFF" or "RDM OFF".
3. Press the [  ENT ] button.

### Notes:

- When the repeat play mode is canceled, after play all tracks within a selected category, playback will begin from the first track in the selected category.
- When playing the last track within a selected category in Random mode, if ACC is switched off then on again, playback will begin from a different track.
- Though the default setting of an iPod is "All Repeat", the indication on the mode status is not displayed.

## Selecting category from the iPod menu

1. Press the [MENU] button.  
The iPod menu categories will be displayed.
2. Press the [UP] or [DN] button to switch between categories.  
The iPod menu categories alternate in the following order:  
"PLAYLISTS" ↔ "ARTISTS" ↔ "ALBUMS"  
↔ "SONGS" ↔ "GENRES" ↔  
"COMPOSERS" ↔ "PLAYLISTS" ...

### Notes:

- The iPod menu mode can be canceled by pressing the [MENU] button.
  - In iPod menu mode, if you push the [SEEK PANEL] or press the [UP] or [DN] button fast, playback may not be performed.
3. Push the [SEEK PANEL] rightward to select the category.
  4. When the track name display is showing, push the [SEEK PANEL] rightward.  
Playback will begin from the first track in the selected category, and the iPod menu mode will be canceled.

- \* Subfolders may be displayed, depending on the category.  
In this case, press the [UP] or [DN] button to switch between subfolders, then push the [SEEK PANEL] rightward to select the desired subfolder.
  - \* When the track name display is showing, pushing the [SEEK PANEL] leftward will return to the currently playing folder name display.
5. Press the [UP] or [DN] button to select a track within a category.
  6. Push the [SEEK PANEL] rightward to play the desired track.

## About title display

This unit supports the display of title information transmitted from a connected iPod.

- Character code information is UTF-8; displayable characters include English alphanumerics, some symbols, and some umlaut characters.
- Unsupported characters will be replaced by asterisks (\*).

This function is available when a Satellite Radio Receiver is connected through the CeNET cable.

This unit can control the following satellite radio receivers:

- XM Satellite Interface Adapter (Mini-Tuner Included) : CNP2000UC  
Clarion cable for CNP2000UC : CNPCLA1
- SIRIUS Satellite Radio Receiver : SIRCL3
- SIRIUS Satellite Translator Adapter :  
CLA-SC1 (which needs Sirius universal Tuner sold separately.)

#### Note:

- When the function is differ depending to the connected receiver, they are distinguished by the following notations:  
"XM": for an XM Satellite Radio Receiver  
"SIRIUS": for a SIRIUS Satellite Radio Receiver

## Selecting a Satellite Radio mode

1. Press the [SRC] button.

The system changes to the specified Satellite Radio mode.

## Selecting a band

1. Press the [MENU] button to select a band.

This changes the reception band as follows:

- XM: XM1 → XM2 → XM3 → XM1 ...
- SIRIUS: SR1 → SR2 → SR3 → SR1 ...

### ● Information displayed during reception

The following information is displayed when the satellite radio cannot be received normally.

- When the receiver is turned on the first time or after a reset: "UPDATING"
- When a channel is being tuned in (no signal is yet received):  
XM: "LOADING", SIRIUS: "ACQUIRING"
- A channel without a broadcast has been selected:  
XM: "-- -- CH", SIRIUS: "INVALID CH"
- A channel not covered by your contract:  
XM: "UPDATING", SIRIUS: "CALL 888" ↔  
"539-SIRI" (alternated)
- When your contract is expired: "SUB UPDATE"

## Confirming your SIRIUS ID

1. Press the [OPTION] button.
2. Push the [SEEK PANEL] leftward or rightward to select "SID DISP".
3. Press the [UP] or [DN] button.  
Your SIRIUS ID will be displayed 6 digits number.
4. To return to the previous mode, press the [OPTION] button.

## Displaying channel labels

1. Press the [D] button to select the desired channel label.  
Channel → Category → Artist → Title →  
Radio text → Channel...

## Channel selection

1. Channels are selected with the [SEEK PANEL].  
\* For details, see the following operation descriptions.

#### Note:

- The audio output is muted and other button operations are not accepted during channel selection.

## Tuning mode

There are two channel selection modes: quick tuning mode and step tuning mode.

### ● Quick tuning

1. Push the [SEEK PANEL] leftward or rightward and hold in position for 1 second or longer.

### ● Step tuning

1. Push the [SEEK PANEL] leftward or rightward.

## Satellite Radio Operations

### Recalling a preset station



A total of 18 satellite radio stations can be stored.

- **XM:** 6-XM1, 6-XM2 and 6-XM3
- **SIRIUS:** 6-SR1, 6-SR2 and 6-SR3

This allows you to store your favorite satellite radio stations in memory for later recall.

1. Press the **[MENU]** button to select the desired band.
2. Push the **[SEEK PANEL]** leftward or rightward to select the desired preset station.

### Preset memory

1. Press the **[MENU]** button to select the desired band.
2. Select the desired channel with quick tuning or step tuning.
3. Press the [  **ENT** ] button to enter the P.CH memory screen.
4. Press the **[UP]** or **[DN]** button to select the desired preset channel.
5. Press and hold the [  **ENT** ] button for 2 seconds or longer to store the current channel into preset memory.

### Receiving stations selected by category

Satellite Radio allows you to select broadcast channel category (contents).

1. Press and hold the **[MENU]** button for 1 second or longer to select the category selection mode.
  - \* It press once again, return to the channel selection mode.
2. Press the **[UP]** or **[DN]** button to change the category item.
3. Push the **[SEEK PANEL]** leftward or rightward to tune in a station.

#### Note:

- When the category selection mode is entered, the category of the last received channel is displayed first.
- The category selection mode is canceled when no channel with the selected category can be found.
- If the **[SEEK PANEL]** are not pushed within 7 seconds, the category selection mode is canceled, and resumes to the channel mode.

### Scan function

There are two scan modes: the category scan mode and the preset scan mode.

During scanning channels are displayed in abbreviated form, the display mode cannot be switched.

#### ● Category scan (CATEGORY SCN)

In a category scan, broadcast channels in the same category as the current channel are selected about every 10 seconds.

1. Press the **[OPTION]** button.
2. Push the **[SEEK PANEL]** leftward or rightward to select "**CATEGORY SCN**".
3. Press the [  **ENT** ] button.

#### Note:

- Category scanning is not available when no category is defined for the current channel.

#### ● Preset scan (PRESET SCN)

A preset scan scans the channels (up to 18 channels) stored in the preset memory about every 10 seconds.

1. Press the **[OPTION]** button.
2. Push the **[SEEK PANEL]** leftward or rightward to select "**PRESET SCN**".
3. Press the [  **ENT** ] button.



## Note:

- The following operations are the same as for CD mode:

- \*Pause
- \*Track selection
- \*Fast-forward/fast-backward
- \*Scan play
- \*Repeat play
- \*Random play

See “CD/MP3/WMA/AAC Operations” (page 19-23) for details.

## CD changer functions

When an optional CD changer is connected through the CeNET cable, this unit controls all CD changer functions. This unit can control a total of 2 changers.

Press the [SRC] button and select the CD changer mode to start play. If 2 CD changers are connected, press the [SRC] button to select the CD changer for play.

- \* If “NO MAG” appears in the display, insert the magazine into the CD changer. “DISC CHECK” appears in the display while the player loads (checks) the magazine.
- \* If “NO DISC” appears in the display, eject the magazine and insert discs into each slot. Then, reinsert the magazine back into the CD changer.

## Note:

- Some CDs recorded in CD-R/CD-RW mode may not be usable.

## ⚠ CAUTION

**CD-ROM discs cannot be played from every CD changer, it's depended on the model.**

## Displaying CD titles

This unit can display title data for CD-text CDs and user titles input with this unit.

1. Press the [D] button to change the title display.

## Procedure to scroll a title

Set “AUTO SCR” to “ON” or “OFF”.

(The factory default setting is “ON”. Refer to the subsection “Setting the method for title scroll” in section “Operations Common to Each Mode”.)

### ● When set to “ON”

The title is automatically kept scrolling.

### ● When set to “OFF”

To scroll just 1 time.

When you want to see the title again in the title mode, press and hold the [D] button for 1 second or longer to scroll the title.

## Note:

- User title can't scroll.

## Selecting a CD

1. Press the [UP] or [DN] button to select a desired disc in the magazine.
  - \* If a CD is not loaded in a slot of magazine, “NO DISC” appears in the display

## Other various play functions

### ● Disc scan play

Disc scan play locates and plays the first 10 seconds of the first track on each disc in the currently selected CD changer. This function continues automatically until it is cancelled.

- \* Disc scan play is useful when you want to select a desired CD.

1. Press the [OPTION] button.
2. Push the [SEEK PANEL] leftward or rightward to select “SCN”.
3. Press the [UP] or [DN] button to select “ALL”, and then press the [▶|| ENT] button. “ALL SCAN” appears in the display and disc scan play starts.

### ● Disc repeat play

After all the tracks on the current disc have been played, disc repeat play automatically replays the current disc over from the first track. This function continues automatically until it is cancelled.

1. Press the [OPTION] button.
2. Push the [SEEK PANEL] leftward or rightward to select “RPT”.
3. Press the [UP] or [DN] button to select “ALL”, and then press the [▶|| ENT] button. “ALL RPT” appears in the display and disc repeat play starts.

## CD Changer Operations

### ● Disc random play

The disc random play selects and plays individual tracks or discs automatically in no particular order. This function continues automatically until it is cancelled.

1. Press the [OPTION] button.
2. Push the [SEEK PANEL] leftward or rightward to select "RDM".
3. Press the [UP] or [DN] button to select "ALL", and then press the [▶|| ENT] button. "ALL RDM" appears in the display and disc random play starts.

### ● To cancel the trick play

1. Press the [OPTION] button.
2. Push the [SEEK PANEL] leftward or rightward to select "TRICK PLAY OFF".
3. Press the [▶|| ENT] button to cancel the trick play.

## DVD Changer Operations

By connecting an optional DVD changer that supports CeNET wiring, this unit can be used to control the DVD changer. To view DVDs, an optional monitor is required.

- The DVD control and display functions supported by this unit are limited; the unit does not support all the functions possible on a DVD changer.

For fullest functionality, use the remote control unit provided with your DVD changer to control its operations. For details, consult the Owner's Manual provided with your DVD changer.

### Note:

- The following operations are the same as for CD and CD Changer modes:

\*Pause

\*Track selection

\*Fast-forward/fast-backward

\*Scan play

\*Repeat play

\*Random play

See "CD/MP3/WMA/AAC Operations" (page 19-23) and "CD Changer Operations" (page 33-34) for details.

## Note:

- The following operations are performed the same as for radio mode:

\***Channel selection**

\***Storing channels in memory**

\***Calling channels from memory**

\***Auto store**

\***Preset scan**

See “Radio Operations” (page 17-18) for details.

## TV tuner functions

When an optional TV tuner is connected through the CeNET cable, this unit controls all TV tuner functions. To watch TV requires a TV tuner and monitor.

### Watching a TV

1. Press the [SRC] button and select the TV mode.
2. Press the [MENU] button to select the desired TV band (TV1 or TV2). Each time the button is pressed, the input selection toggles between TV1 and TV2.
3. Push the [SEEK PANEL] leftward or rightward to tune in the desired TV station.

### Watching a video

The TV tuner has a VTR input terminal to which 1 external device can be connected. Connect a 12 V video cassette player (VCP) or video cassette recorder (VCR) to the TV tuner input terminal.

1. Press the [OPTION] button.
2. Push the [SEEK PANEL] leftward or rightward to select “TV/VTR”.
3. Press the [▶|| ENT] button to enter the VTR mode.
4. To return to the TV broadcast, press the [OPTION] button.
5. Press the [▶|| ENT] button to return to the TV mode.

## Setting the TV diver

You can change the reception setting for the TV antenna connected to the TV tuner.

1. Press the [OPTION] button to switch to the adjustment selection display.
2. Push the [SEEK PANEL] leftward or rightward to select “TV DIVER”.
3. Press the [UP] or [DN] button to set to “ON” or “OFF”.
  - **ON:**  
Sets the diver setting to ON.
  - **OFF:**  
Sets the diver setting to OFF.
4. Press the [OPTION] button to return to the previous mode.

# 8. TROUBLESHOOTING

	Problem	Cause	Measure
General	Power does not turn on. (No sound is produced.)	Fuse is blown.	Replace with a fuse of the same amperage. If the fuse blows again, consult your store of purchase.
		Incorrect wiring.	Consult your store of purchase.
	No sound output when operating the unit with amplifiers or power antenna attached.	Power antenna lead is shorted to ground or excessive current is required for remote-on the amplifiers or power antenna.	<ol style="list-style-type: none"> <li>1. Turn the unit off.</li> <li>2. Remove all wires attached to the power antenna lead. Check each wire for a possible short to ground using an ohm meter.</li> <li>3. Turn the unit back on.</li> <li>4. Reconnect each amplifier remote wire to the power antenna lead one by one. If the amplifiers turn off before all wires are attached, use an external relay to provide remote-on voltage (excessive current required).</li> </ol>
	Nothing happens when buttons are pressed.	The microprocessor has malfunctioned due to noise, etc.	Turn off the power, then press the <b>[OPEN]</b> button and remove the DCP. Press the reset button for about 2 seconds with a thin rod.
	Display is not accurate.		
	DCP or main unit connectors are dirty.	Wipe the dirt off with a soft cloth moistened with cleaning alcohol.	
	No sound heard	The speaker protection circuit is operating.	<ol style="list-style-type: none"> <li>1. Turn down sound volume. Function can also be restored by turning the power off and on again. (Speaker volume is reduced automatically when the speaker protection circuit operates).</li> <li>2. If the sound is muted again, consult our service department.</li> </ol>
CD/MP3/WMA/AAC	No sound heard	MP3/WMA/AAC files are absent in a disc.	Write MP3/WMA/AAC files onto the disc properly.
		Files are not recognized as an MP3/WMA/AAC file.	Use MP3/WMA/AAC files encoded properly.
		File system is not correct.	Use ISO9660 level 1, 2 or JOLIET or Romeo or APPLE ISO file system.
	Sound skips or is noisy.	Compact disc is dirty.	Clean the compact disc with a soft cloth.
		Compact disc is heavily scratched or warped.	Replace with a compact disc with no scratches.
	Sound is cut or skipped. Noise is generated or noise is mixed with sound.	MP3/WMA/AAC files are not encoded properly.	Use MP3/WMA/AAC files encoded properly.
	Sound is bad directly after power is turned on.	Water droplets may form on the internal lens when the car is parked in a humid place.	Let dry for about 1 hour with the power on.
Wrong filename	File system is not correct.	Use ISO9660 level 1, 2 or JOLIET or Romeo or APPLE ISO file system.	

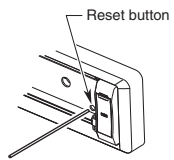

	Problem	Cause	Measure
USB/MTP/iPod	No sound heard	The device contains no MP3/WMA/AAC files.	Record MP3/WMA/AAC files properly to the device.
		The files are not proper MP3/WMA/AAC format.	Use only properly encoded MP3/WMA/AAC files.
		Connectors are loose.	Disconnect the device and reconnect securely.
	Sound is interrupted or has noise.	The MP3/WMA/AAC files are improperly encoded.	Use only properly encoded MP3/WMA/AAC files.
	The device isn't recognized.	The device is damaged.	Disconnect the device and reconnect. If the device is still not recognized, try replacing with a different device.
		Connectors are loose.	
		According to the state of operation on the device, the communication fault is caused.	Disconnect the device and reconnect.
Can't insert the device.	The device has been inserted improperly.	Try reversing the connection direction of the device (usually the brand name surface should be facing left).	
	The connector is broken.	Replace with a new device.	

# 9. ERROR DISPLAYS

If an error occurs, one of the following displays is displayed.  
 Take the measures described below to eliminate the problem.

	Error Display	Cause	Measure
CD/MP3/WMA/AAC	<b>ERROR 2</b>	A CD is caught inside the CD deck and is not ejected.	This is a failure of CD deck's mechanism and consult your store of purchase.
	<b>ERROR 3</b>	A CD cannot be played due to scratches, etc.	Replace with a non-scratched, non-warped-disc.
	<b>ERROR 6</b>	A CD is loaded upside-down inside the CD deck and does not play.	Eject the disc then reload it properly.
CD changer	<b>ERROR 2</b>	A CD inside the CD changer is not loaded.	This is a failure of CD changer's mechanism and consult your store of purchase.
	<b>ERROR 3</b>	A CD inside the CD changer cannot be played due to scratches, etc.	Replace with a non-scratched, non-warped disc.
	<b>ERROR 6</b>	A CD inside the CD changer cannot be played because it is loaded upside-down.	Eject the disc then reload it properly.
DVD changer	<b>ERROR 2</b>	A DISC inside the DVD changer cannot be played.	This is a failure of DVD mechanism and consult your store of purchase.
	<b>ERROR 3</b>	A DISC cannot be played due to scratches, etc.	Retry or replace with a non-scratched, non-warped-disc.
	<b>ERROR 6</b>	A DISC inside the DVD changer cannot be played because it is loaded upside-down.	Eject the disc then reload it properly.
	<b>ERROR P</b>	Parental level error	Set the correct Parental level.
	<b>ERROR R</b>	Region code error	Eject the disc and replace correct region code disc.
USB/MTP/iPod	<b>ERROR 2</b>	The files are not proper MP3/WMA/AAC format.	Use only properly encoded MP3/WMA/AAC files.
	<b>ERROR 3 (USB/MTP mode)</b>	The MP3/WMA/AAC files are improperly encoded.	Use only properly encoded MP3/WMA/AAC files.
	<b>ERROR 3 (iPod mode)</b>	The iPod contains no audio files.	Insert an iPod containing audio files.
	<b>ERROR 5</b>	The connected devices are not recognized	Disconnect the devices and reconnect.
	<b>BUS-PWR</b>	Overcurrent detection.	Disconnect the devices and reconnect. If the devices are still not recognized, try replacing with a different devices.
	<b>HUB</b>	The connected devices are not recognized.	Disconnect the devices and reconnect. If the devices are still not recognized, try replacing with a different devices.

If an error display other than the ones described above appears, press the reset button. If the problem persists, turn off the power and consult your store of purchase.

# 10.SPECIFICATIONS

## FM Tuner

Frequency Range: 87.9 MHz to 107.9 MHz  
 Usable Sensitivity: 9 dBf  
 50dB Quieting Sensitivity: 15 dBf  
 Alternate Channel Selectivity: 70 dB  
 Stereo Separation (1 kHz): 35 dB  
 Frequency Response ( $\pm 3$  dB): 30 Hz to 15 kHz

## AM Tuner

Frequency Range: 530 kHz to 1710 kHz  
 Usable Sensitivity: 25  $\mu$ V

## CD Player

System: Compact disc digital audio system  
 Usable Discs: Compact disc  
 Frequency Response ( $\pm 1$  dB): 5 Hz to 20 kHz  
 Dynamic Range (1 kHz): 95 dB  
 Harmonic Distortion: 0.01%

## Audio

Maximum Power Output: 212 W (53 W  $\times$  4 ch)  
 Bass Control Action (80 Hz): +14 dB, -14 dB  
 Treble Control Action (10 kHz): +12 dB, -12 dB  
 Line Output Level (CD 1 kHz): 5.7 V

### Note:

- Specifications and design are subject to change without notice for further improvement.

## General

Power Supply Voltage:  
 14.4 V DC (10.8 to 15.6 V allowable), negative ground  
 Current Consumption: Less than 15 A  
 Speaker Impedance: 4  $\Omega$  (4  $\Omega$  to 8  $\Omega$  allowable)  
 Auto Antenna Rated Current: 500 mA or less  
 Weight / Source unit: 2.75 lb. (1.6 kg)  
 Weight / Remote control unit:  
 1.41 oz. (40 g) (including battery)  
 Dimensions / Source unit:  
 7" (Width)  $\times$  2" (Height)  $\times$  6-1/8" (Depth)  
 [178 (W)  $\times$  50 (H)  $\times$  158 (D) mm]  
 Dimensions / Remote control unit:  
 1-3/4" (Width)  $\times$  4-5/16" (Height)  $\times$  7/16"  
 (Depth)  
 [44 (W)  $\times$  113 (H)  $\times$  11 (D) mm]

### Power Output :

18 W RMS x 4 Channels at 4  
 and 1 % THD+N

### Signal to Noise Ratio:

84 dBA (reference: 1 W into 4 )



# 11.OTHERS

## ***WMDRM 10 for devices***

- This product is protected by certain intellectual property rights of Microsoft. Use or distribution of such technology outside of this product is prohibited without a license from Microsoft.
- Content owners use Windows Media digital rights management technology (WMDRM) to protect their intellectual property, including copyrights. This device uses WMDRM software to access WMDRM-protected content. If the WMDRM software fails to protect the content, content owners may ask Microsoft to revoke the software's ability to use WMDRM to play or copy protected content. Revocation does not affect unprotected content. When you download licenses for protected content, you agree that Microsoft may include a revocation list with the licenses. Content owners may require you to upgrade WMDRM to access their content. If you decline an upgrade, you will not be able to access content that requires the upgrade.



# Clarion Co., Ltd.

---

All Rights Reserved. Copyright © 2007: Clarion Co., Ltd.  
Printed in China / Imprimé en Chine / Impreso en China

**PE-3044B**  
**280-8595-00**

2007/12

## Free Manuals Download Website

<http://myh66.com>

<http://usermanuals.us>

<http://www.somanuals.com>

<http://www.4manuals.cc>

<http://www.manual-lib.com>

<http://www.404manual.com>

<http://www.luxmanual.com>

<http://aubethermostatmanual.com>

Golf course search by state

<http://golfingnear.com>

Email search by domain

<http://emailbydomain.com>

Auto manuals search

<http://auto.somanuals.com>

TV manuals search

<http://tv.somanuals.com>