

# Clarion

Owner's manual

使用说明书

사용 설명서

## ***DXZ756MC***

**CD/MP3/WMA Receiver / CeNET Control  
& Music Catcher**

**CD/MP3/WMA接收器/ CeNET控制& Music  
Catcher**

**CD/MP3/WMA 리시버 / CeNET 컨트롤 & 뮤  
직 캐처**

**CeNET**

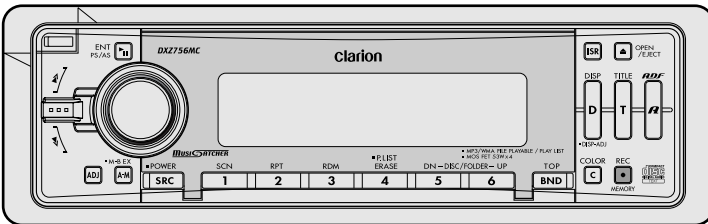

Thank you for purchasing this **Clarion** product.

\* Please read this owner's manual in its entirety before operating this equipment.

\* After reading this manual, be sure to keep it in a handy place (e.g., glove compartment).

\* This manual includes the operating procedures of the CD changer and TV tuner connected via the CeNET cable. The CD changer and TV tuner have their own manuals, but no explanations for operating them are described.

# Contents

<b>1. FEATURES</b> .....	2
<b>2. PRECAUTIONS</b> .....	3
Sloping Console .....	4
Handling Compact Discs .....	4
<b>3. CONTROLS</b> .....	5
<b>4. NOMENCLATURE</b> .....	6
Names of the Buttons and their Functions .....	6
Major Button Operations When External Equipment is Connected to This Unit .....	7
Display Items .....	8
LCD Screen .....	8
<b>5. DCP</b> .....	9
<b>6. REMOTE CONTROL</b> .....	10
Inserting the Battery .....	10
Functions of the Remote Control Unit Buttons .....	11
<b>7. OPERATIONS</b> .....	12
Basic Operations .....	12
Radio Operations .....	14
CD/MP3/WMA Operations .....	16
MUSIC CATCHER Operations .....	20
Common Operations .....	21
<b>8. OPERATIONS OF ACCESSORIES</b> .....	26
CD Changer Operations .....	26
TV Operations .....	28
<b>9. IN CASE OF DIFFICULTY</b> .....	30
<b>10. ERROR DISPLAYS</b> .....	32
<b>11. SPECIFICATIONS</b> .....	33

## 1. FEATURES

- Full-Dot, High-Contrast Positive Display With Eye-Catching Graphics
- 728 Variable Colors (Display/Function Keys)
- MP3 and WMA Playback With ID3-TAG and WMA-TAG Display Capability
- High-Powered Internal MOSFET Amplifier (53 Watts x 4 Channels)
- Music Catcher for One-Touch CD Recording (Up to 80 Songs)
- Shock-Proof Memory for Skip-Free CD Playback
- 6-Channel RCA Output for Easy System Expansion
- Auxiliary Input for External Device Connection
- 2-Band Parametric EQ and ADF Compressed Audio Enhancer
- Aluminum Motorized Detachable Faceplate

## 2. PRECAUTIONS

1. When the inside of the car is very cold and the player is used soon after switching on the heater moisture may form on the disc or the optical parts of the player and proper playback may not be possible. If moisture forms on the disc, wipe it off with a soft cloth. If moisture forms on the optical parts of the player, do not use the player for about one hour. The condensation will disappear naturally allowing normal operation.
2. Driving on extremely bumpy roads which cause severe vibration may cause the sound to skip.
3. This unit uses a precision mechanism. Even in the event that trouble arises, never open the case, disassemble the unit, or lubricate the rotating parts.

### **⚠ CAUTION**

**USE OF CONTROLS, ADJUSTMENTS, OR PERFORMANCE OF PROCEDURES OTHER THAN THOSE SPECIFIED HEREIN, MAY RESULT IN HAZARDOUS RADIATION EXPOSURE.**

**THE COMPACT DISC PLAYER and MINI DISC PLAYER SHOULD NOT BE ADJUSTED OR REPAIRED BY ANYONE EXCEPT PROPERLY QUALIFIED SERVICE PERSONNEL.**

**CHANGES OR MODIFICATIONS NOT EXPRESSLY APPROVED BY THE MANUFACTURER FOR COMPLIANCE COULD VOID THE USER'S AUTHORITY TO OPERATE THE EQUIPMENT.**

#### **INFORMATION FOR USERS:**

**CHANGES OR MODIFICATIONS TO THIS PRODUCT NOT APPROVED BY THE MANUFACTURER WILL VOID THE WARRANTY.**

## Sloping Console

This unit uses sloping console to make large-screen displays possible.

When you use the sloping console, be sure to close it.

### CAUTION



**BE CAREFUL NOT TO GET YOUR FINGERS CAUGHT WHEN OPENING AND CLOSING THE SLOPING CONSOLE.**

1. For safety's sake, always close the SLOPING CONSOLE before leaving this unit unused for a prolonged period or switching OFF the ignition key.

If you switch OFF the ignition key with the SLOPING CONSOLE tilted, the SLOPING CONSOLE does not close.

2. Before the SLOPING CONSOLE closes, there may be a braking sound from the safety mechanism. This is normal.
3. If you move the SLOPING CONSOLE by hand, this may create play. To correct this play, with the power on for the unit, press the [▲] button to close the SLOPING CONSOLE.
4. After a disc is ejected, the SLOPING CONSOLE automatically returns to the tilted or closed state. If there is any obstruction when the SLOPING CONSOLE tries to close, the safety mechanism is triggered and the SLOPING CONSOLE returns to the open state. If this happens, remove the obstruction, then press the [▲] button.
5. To avoid scratching the compact disc, keep the 12 or 8 cm CD level when inserting or removing them.

## Handling Compact Discs

Use only compact discs bearing the  or  mark.

Do not play heart-shaped, octagonal, or other specially shaped compact discs.

Some CDs recorded in CD-R/CD-RW mode may not be usable.

### Handling

- Compared to ordinary music CDs, CD-R and CD-RW discs are both easily affected by high temperature and humidity and some of CD-R and CD-RW discs may not be played. Therefore, do not leave them for a long time in the car.
- New discs may have some roughness around the edges. If such discs are used, the player may not work or the sound may skip. Use a ball-point pen or the like to remove any roughness from the edge of the disc.
- Never stick labels on the surface of the compact disc or mark the surface with a pencil or pen.
- Never play a compact disc with any cellophane tape or other glue on it or with peeling off marks. If you try to play such a compact disc, you may not be able to get it back out of the CD player or it may damage the CD player.

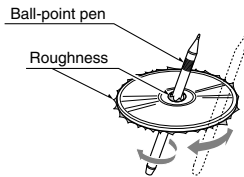

- Do not use compact discs that have large scratches, are misshapen, cracked, etc. Use of such discs may cause misoperation or damage.
- To remove a compact disc from its storage case, press down on the center of the case and lift the disc out, holding it carefully by the edges.
- Do not use commercially available CD protection sheets or discs equipped with stabilizers, etc. These may damage the disc or cause breakdown of the internal mechanism.

### Storage

- Do not expose compact discs to direct sunlight or any heat source.
- Do not expose compact discs to excess humidity or dust.
- Do not expose compact discs to direct heat from heaters.

### Cleaning

- To remove fingermarks and dust, use a soft cloth and wipe in a straight line from the center of the compact disc to the circumference.
- Do not use any solvents, such as commercially available cleaners, anti-static spray, or thinner to clean compact discs.
- After using special compact disc cleaner, let the compact disc dry off well before playing it.

Be sure to unfold and read the next page. / 务必打开并阅读下一页。  
이 페이지를 펼친 채로 다음 페이지를 읽어 주십시오.

# 3. CONTROLS / 控制 / 컨트롤

Source unit / 主机 / 본체

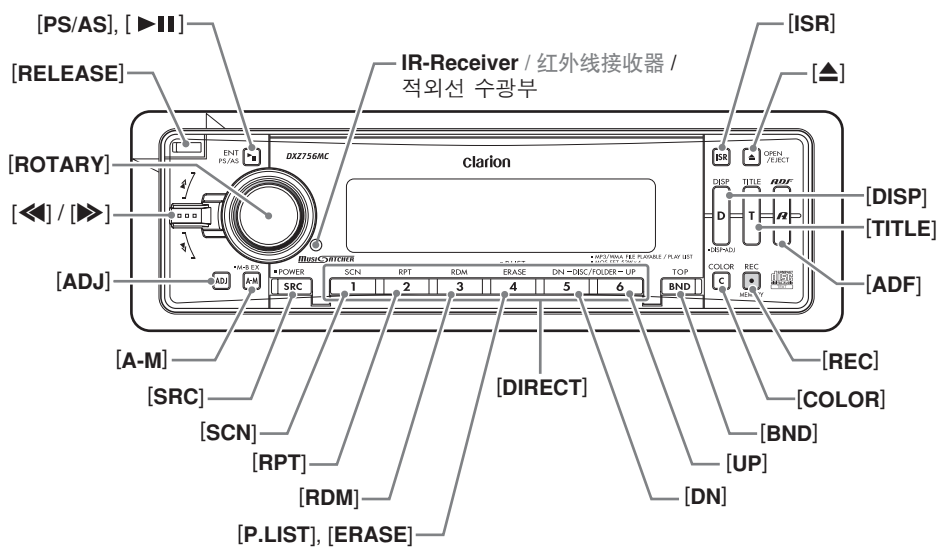

With the SLOPING CONSOLE opened / 在翻开式面板打开时 / 슬로핑 콘솔이 열린 상태

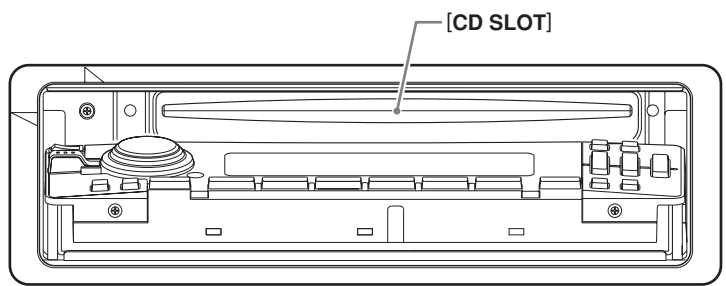

Note: Be sure to unfold this page and refer to the front diagrams as you read each chapter.  
 注: 请务必打开此页, 并在阅读每一章节时参照上面的正视图。  
 주: 이 페이지를 펼쳐두고, 각 장을 읽을 때 전면 그림을 참조하십시오.

# 4. NOMENCLATURE

## Notes:

- Be sure to read this chapter referring to the front diagrams of chapter "3. CONTROLS" on page 5 (unfold).
- MC is the abbreviation of MUSIC CATCHER.
- ADF is the abbreviation of Anti Distortion Filter.

## Names of the Buttons and their Functions

### [RELEASE] button

- Deeply push in the button to unlock the DCP.

### [PS/AS], [▶||] button

- Plays or pauses a CD while in the CD/MP3/WMA, MC mode.
- Performs preset scan in the radio mode. Press and hold for 2 seconds or longer to perform auto store.
- Confirms various settings.

### IR-Receiver

- Receiver for remote control unit. (Operating range: 30° in all directions)

### [ISR] button (Instant station recall)

- Recalls ISR radio station in memory.
- Press and hold for 2 seconds or longer: Stores current station into ISR memory (radio mode only).

### [▲] button

- Press to open the SLOPING CONSOLE and insert a CD into the CD SLOT.
- Press to eject a CD loaded in the unit.

### [DISP] button

- Switches the display indication (main display, sub display, title display).
- Press and hold for 1 second or longer to switch to the display adjust mode.

### [TITLE] button

- Switches the titles.
- Press and hold for 1 second or longer to input or scroll the title.

### [ADF] button

- Selects one of the 4 types of sound characteristics preset in memory.

### [REC] button

- Press during CD playback, and the track currently being played back is recorded onto MC. (TRACK REC)
- Press and hold for 2 seconds or longer during CD playback, and all tracks are recorded onto MC. (DISC REC)

### [COLOR] button

- Press to select display color.

### [BND] button

- Switches the band.
- Press and hold for 1 second or longer to switch seek or manual tuning.
- Returns to a first track while in the CD/MP3/WMA, MC mode.
- Press and hold for 1 second or longer to switch the track type to play in the CD/MP3/WMA mode.

### [UP], [DN] buttons

- Selects the folder. (MP3/WMA disc, MC mode only)

### [DIRECT] buttons

- Stores a station into memory or recalls it directly while in the radio mode.

### [P.LIST], [ERASE] button

- Press and hold for 1 second or longer to turn on or off the play list mode. (MP3/WMA disc only)
- Erases a track or folder in the MC mode.
- Press and hold for 2 seconds or longer to switch to the ALL ERASE mode.

### [RDM] button

- Performs random play while in the CD/MP3/WMA, MC mode.
- Press and hold for 1 second or longer to perform folder random play while in the MP3/WMA disc, MC mode.

### [RPT] button

- Repeats play while in the CD/MP3/WMA, MC mode.
- Press and hold for 1 second or longer to perform folder repeat play while in the MP3/WMA disc, MC mode.

### [SCN] button

- Performs scan play for 10 seconds of each track while in the CD/MP3/WMA, MC mode.
- Press and hold for 1 second or longer to perform folder scan play while in the MP3/WMA disc, MC mode.

### [SRC] button

- Press to turn on the power.
- Press and hold for 1 second or longer to turn off the power.
- Switches the operation mode among the radio mode, etc.

### [A-M] button

- Switches to the audio mode (SUB-WOOF VOL, ADF, BASS, TREBLE, BALANCE, FADER).
- Press and hold for 1 second or longer to turn on or off the MAGNA BASS EXTEND.

### [ADJ] button

- Switches to the adjust mode.

### [◀|▶] lever

- Selects a station while in the radio mode or selects a track when listening to the CD/MP3/WMA, MC mode.
- This lever is used to make various settings.
- Move for 1 second or longer to switch the fast-forward/fast-rewind.

### [ROTARY] knob

- Turn to adjust the volume.
- Performs various settings.

### [CD SLOT]

- CD insertion slot.

# Major Button Operations When External Equipment is Connected to This Unit

## ● When the CD/DVD changer is connected

- \* For details, see the section “**CD Changer Operations**”. For the DVD changer, refer to the Owner’s Manual provided with the DVD changer.

### [▶||] button

- Plays or pauses a CD or DVD.

### [DISP] button

- Switches the display indication (main display, sub display, title display).

### [TITLE] button

- Switches the titles.
- Press and hold for 1 second or longer to input or scroll the title.

### [BND] button

- Advances to next disc.

### [UP], [DN] buttons

- Selects the disc.

### [RDM] button

- Performs random play.
- Press and hold for 1 second or longer to perform disc random play.

### [RPT] button

- Performs repeat play.
- Press and hold for 1 second or longer to perform disc repeat play.

### [SCN] button

- Performs scan play for 10 seconds of each track.
- Press and hold for 1 second or longer to perform disc scan play.

### [◀|/▶] lever

- Repeats or advances a track when listening to a disc.
- Move for 1 second or longer to switch the fast-forward/fast-rewind.

## ● When the TV is connected

- \* For details, see the section “**TV Operations**”.

### [PS/AS] button

- Performs preset scan. Press and hold for 2 seconds or longer to perform auto store.

### [BND] button

- Switches the band.
- Press and hold for 1 second or longer to switch seek or manual tuning.

### [DIRECT] buttons

- Stores a station into memory or recalls it directly.

### [ADJ] button

- Press and hold for 1 second or longer to switch the TV picture mode or VTR (external) picture mode.

### [◀|/▶] lever

- Selects a station.

# Display Items

## Main display

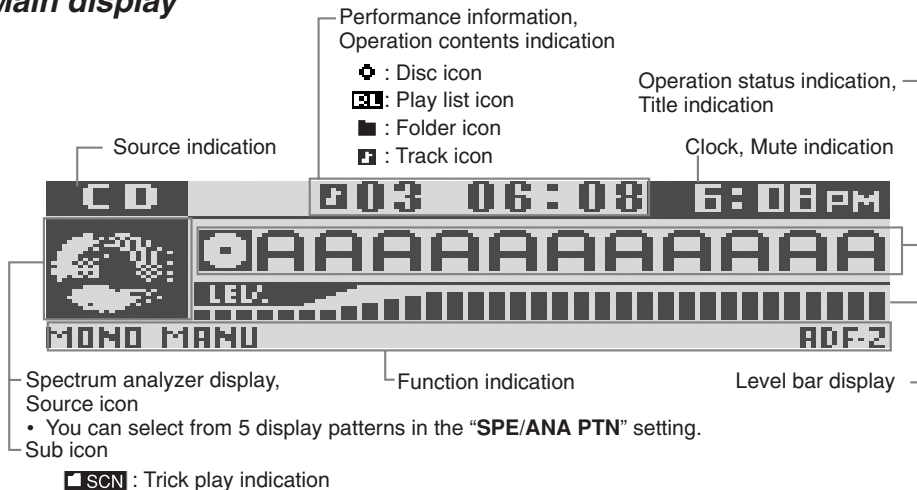

■ SCN : Trick play indication

## Sub display



## Title display



- You cannot change the combination of the upper and lower title to your preference. The user title is displayed only in the upper title, and the lower title does not appear.
- The title display does not appear in the radio, TV, AUX or DVD changer mode.

Operation status indication, Title indication

## LCD Screen

In extreme cold, the screen movement may slow down and the screen may darken, but this is normal. The screen will recover when it returns to normal temperature.



# 5. DCP

The control panel can be detached to deter theft. When detaching the control panel, store it in the DCP (DETACHABLE CONTROL PANEL) case to prevent scratches.

We recommend taking the DCP with you when leaving the car.

## Removing the DCP

1. With the SLOPING CONSOLE closed, turn off the power.
2. Press the [RELEASE] button deeply to open the DCP.

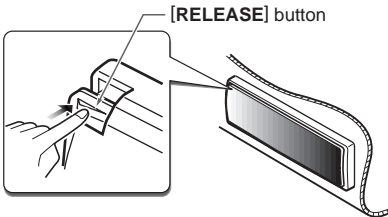

3. Pull the DCP toward you and remove it.

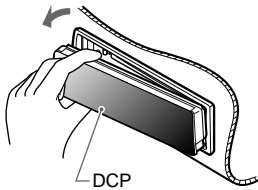

### CAUTION

- Always close the SLOPING CONSOLE before removing the DCP.
- If you remove the DCP with the SLOPING CONSOLE open, the sloping console closes immediately. Be careful not to get your fingers caught.

## Attaching the DCP

1. Insert the DCP so that the (A) section on the right side of the DCP catches on the hook (B) on the unit.

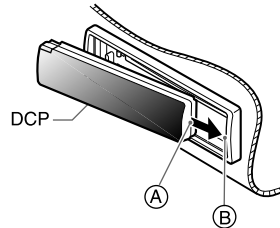

2. Press the left side (C) of the DCP carefully to fit it in place.

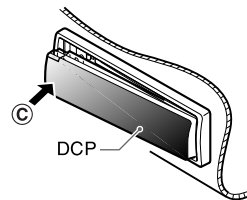

### CAUTION

- The DCP can easily be damaged by shocks. After removing it, be careful not to drop it or subject it to strong shocks.
- If the [RELEASE] button is pressed and the DCP is not locked into place, it may fall out from vibration of the car. This can break the DCP, so after removing it, either install it on the unit or put it in its DCP case.
- The connector connecting the unit and the DCP is an extremely important part. Be careful not to damage it by pressing on it with fingernails, screwdrivers, etc.

#### Note:

- If the DCP is dirty, wipe off the dirt with a soft, dry cloth only.

# 6. REMOTE CONTROL

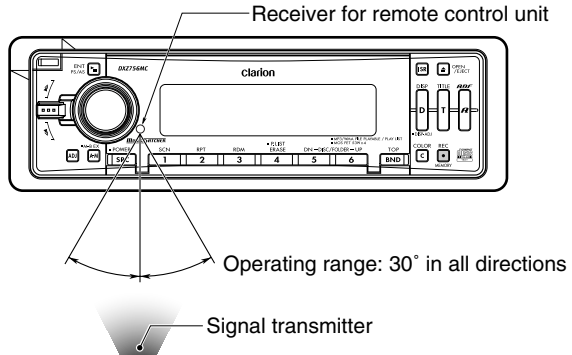

## Remote control unit

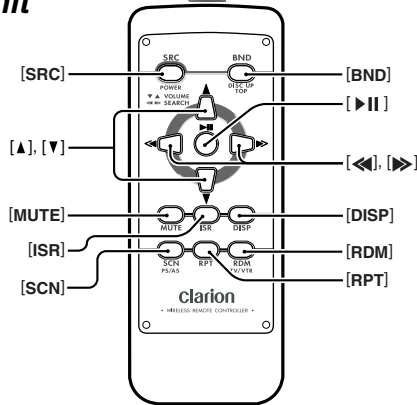

## Inserting the Battery

- Turn over the remote control unit and slide the cover in the direction indicated by the arrow in the illustration.
- Insert the battery (CR2025) into the insertion guides, with the printed side (+) facing upwards.
- Press the battery in the direction indicated by the arrow so that it slides into the compartment.
- Replace the cover and slide in until it clicks into place.

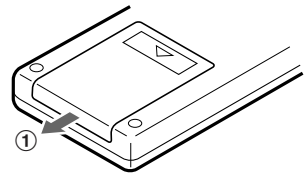

### Notes:

Misuse may result in rupture of the battery, producing leakage of fluid and resulting in personal injury or damage to surrounding materials. Always follow these safety precautions:

- Use only the designated battery.
- When replacing the battery, insert properly, with +/- polarities oriented correctly.
- Do not subject battery to heat, or dispose of in fire or water. Do not attempt to disassemble the battery.
- Dispose of used batteries properly.

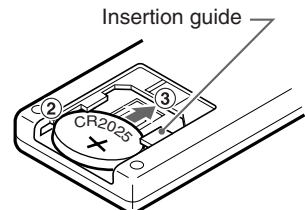

# Functions of the Remote Control Unit Buttons

Mode Button	Radio	CD/MP3/WMA/ M.CATCHER	CD changer DVD changer	TV
[SRC]	Switches among radio, CD/MP3/WMA, MC, CD changer, DVD changer, TV and AUX.			
[BND]	Switches reception band.	Returns to the first track.	Moves the next disc in increasing order.	Switches reception band.
[▲] , [▼]	Increases and decreases volume (in all modes).			
[◀] , [▶]	Moves preset channels up and down.	Moves tracks up and down. When pressed and held for 1 second or longer: Fast-forward/fast-rewind.		Moves preset channels up and down.
[▶  ]	No function.	Switches between playback and pause.		No function.
[MUTE]	Turns mute on and off.			
[ISR]	Recalls ISR radio station in memory. When pressed and held for 2 seconds or longer: Stores current station into ISR memory (radio mode only).			
[DISP]	Switches among main display, sub display and title display. When pressed and held for 1 second or longer: Switches the titles (except in the radio, DVD changer, TV mode).			
[SCN]	Preset scan. When pressed and held for 2 seconds or longer: Auto store.	Scan play. When pressed and held for 1 second or longer: Folder scan play (MP3/WMA disc, MC mode).	Scan play. When pressed and held for 1 second or longer: Disc scan play.	Preset scan. When pressed and held for 2 seconds or longer: Auto store.
[RPT]	No function.	Repeat play. When pressed and held for 1 second or longer: Folder repeat play (MP3/WMA disc, MC mode).	Repeat play. When pressed and held for 1 second or longer: Disc repeat play.	No function.
[RDM]	No function.	Random play. When pressed and held for 1 second or longer: Folder random play (MP3/WMA disc, MC mode).	Random play. When pressed and held for 1 second or longer: Disc random play.	Switches between TV and VTR.

\* Some of the corresponding buttons on the main unit and remote control unit have different functions.

# 7. OPERATIONS

## Basic Operations

*Note:* Be sure to read this chapter referring to the front diagrams of chapter "3. CONTROLS" on page 5 (unfold).

### ⚠ CAUTION

Be sure to lower the volume before switching off the unit power or the ignition key. The unit remembers its last volume setting. If you switch the power off with the volume up, when you switch the power back on, the sudden loud volume may hurt your hearing and damage the unit.

### Turning on/off the power

#### Note:

• Be careful about using this unit for a long time without running the engine. If you drain the car's battery too far, you may not be able to start the engine and this can reduce the service life of the battery.

1. Press the [SRC] button.
2. The illumination and display on the unit light up. The unit automatically remembers its last operation mode and will automatically switch to display that mode.
3. Press and hold the [SRC] button for 1 second or longer to turn off the power for the unit.

#### Note:

##### • System check

During the initial power up of this unit, it will go through a system check procedure. This procedure verifies any devices connected through CeNET. Any additional CeNET devices plugged into the unit after the initial power up will initiate the system check procedure. When the power is turned on, "SYSTEM CHECK" appears in the display if the wire connections were modified. The system check starts automatically within the unit.

### Selecting a mode

1. Press the [SRC] button to change the operation mode.
2. Each time you press the [SRC] button, the operation mode changes in the following order:

**Radio mode → CD/MP3/WMA mode → M.CATCHER mode → CD changer mode → DVD changer mode → TV mode → AUX mode → Radio mode...**

\* External equipment not connected through CeNET will not be displayed.

### Adjusting the volume

1. Press the front part of the [ROTARY] knob. The knob will pop up.
2. Turn the [ROTARY] knob to adjust the volume.
  - \* The volume level is from 0 (minimum) to 33 (maximum).

### Switching the display

#### ● When the power is turned on

1. Each time you press the [DISP] button, the display switches in the following order:

**Main display → Sub display → Title display → Main display ...**

\* Once selected, the preferred display becomes the display default. When a function adjustment such as volume is made, the screen will momentarily switch to that function's display, then revert back to the preferred display several seconds after the adjustment.

\* When you have entered a title in a CD/MP3/WMA, it appears in the display. If you have not entered a title, "NO TITLE" appears in the display. For information on how to enter a title, refer to the subsection "Entering titles" in the section "Common Operations".

#### ● When the power is turned off

1. Each time you press the [DISP] button, the display switches in the following order:

**Clock display → Display off → Clock display...**

### Setting MAGNA BASS EXTEND

The MAGNA BASS EXTEND does not adjust the low frequencies like the normal sound adjustment function, but emphasizes the deep bass frequencies to provide you with a dynamic sound.

\* The factory default setting is "OFF".

1. Press and hold the [A-M] button for 1 second or longer to turn on the MAGNA BASS EXTEND effect. "M-BASS EX ON" appears on the display.
2. Press and hold the [A-M] button for 1 second or longer to turn off the MAGNA BASS EXTEND effect. "M-BASS EX OFF" appears on the display.

**Note:**

- When “**ADF 1**”, “**ADF 2**”, “**ADF 3**” or “**ADF USER**” is selected for ADF (Anti Distortion Filter), setting of **MAGNA BASS EX** cannot be performed.

**Setting the Anti Distortion Filter**

The adopted “**Liveliness Enhancement Filter**” and “**Sound Tone Compensation**” functions allow well-modulated realistic playback without affecting the characteristics of the original sound tone.

This unit is provided with 4 types of sound tone effects stored in memory. Select the one you prefer.

- \* The factory default setting is “**ADF OFF**”.

Each time you press the [**ADF**] button, the tone effect changes in the following order:

“**ADF 1**” → “**ADF 2**” → “**ADF 3**” → “**ADF USER**” → “**ADF OFF**” → “**ADF 1**” ...

- **ADF 1** : suitable for the genuine speakers
- **ADF 2** : suitable for separate speakers
- **ADF 3** : suitable for coaxial speakers
- **ADF USER**: this setting can be adjusted by the user to his or her individual preference.
- **ADF OFF** : no sound effect

**Notes:**

- The volume changes each time the ADF (Anti Distortion Filter) setting is switched. Turn down the volume and the sub-woofer volume before performing a switching operation.
- Sufficient effects cannot be obtained with some speaker systems. In such cases, adjust the volume.

**Adjusting the tone**

Press the [**A-M**] button and select the item to adjust. Each time you press the [**A-M**] button, the item changes as following order:

**●When “ADF 1, 2, 3” is set**

“**SUB-WOOF VOL**” → “**BALANCE**” → “**FADER**” → Last function mode...

**●When “ADF USER” is set**

“**SUB-WOOF VOL**” → “**ADF GAIN**” → “**BALANCE**” → “**FADER**” → Last function mode...

**●When “ADF OFF” is set**

“**SUB-WOOF VOL**” → “**BASS GAIN**” → “**TREBLE GAIN**” → “**BALANCE**” → “**FADER**” → Last function mode...

**Notes:**

- As subwoofer is effective, “**SUB-WOOF VOL**” can be selected.
- The display automatically returns to the previous mode.

**Adjusting the subwoofer**

- \* The factory default setting is “**0**”
- \* This function can be adjusted only when the subwoofer output is set to “**ON**”. For details on how to set the subwoofer, refer to the subsection “**Setting the subwoofer**” in the section “**Common Operations**”.

1. Press the [**A-M**] button to select “**SUB-WOOF VOL**”.
2. Turn the [**ROTARY**] knob to select from -6 to +6.
3. When the adjustment is complete, press the [**A-M**] button several times until the function mode is reached.

**Adjusting the ADF effects (Gain, Filter)**

This adjustment can only be performed when the ADF (Anti Distortion Filter) is set to “**ADF USER**”.

1. Press the [**A-M**] button and select “**ADF GAIN**”.
2. Turn the [**ROTARY**] knob to adjust the gain.
  - \* The factory default setting is “**1**”. (Adjustment range: 1 to 4)
  - \* “**ADF GAIN**” adjusts the filter effect.
3. Move the [◀|▶] lever to select “**ADF FILTER**”.

Turn the [**ROTARY**] knob to select the filter.

- \* The factory default setting is “**MID**”. (Adjustment LOW/MID/HIGH)
  - **LOW** : attenuates high frequencies.
  - **MID** : attenuates low and high frequencies evenly.
  - **HIGH** : attenuates low frequencies.
- 4. When the adjustment is complete, press the [**A-M**] button several times until the function mode is reached.

**Adjusting the bass (Gain, Frequency, Q-curve)**

This adjustment can only be performed when the ADF (Anti Distortion Filter) is set to “**ADF OFF**”.

1. Press the [**A-M**] button and select “**BASS GAIN**”.
2. Turn the [**ROTARY**] knob to adjust the bass.
  - \* The factory default setting is “**0**”. (Adjustment range: -6 to +8)
3. Move the [◀|▶] lever to select “**BASS FREQ**”.

Turn the [**ROTARY**] knob to select the frequency.

- \* The factory default setting is “**50**”. (Adjustment 50/80/120 Hz)

## Basic Operations

- Move the [**◀/▶**] lever to select "**BASS Q**".  
Turn the [**ROTARY**] knob to select the Q-curve.  
\* The factory default setting is "1". (Adjustment 1/1.25/1.5/2)
- When the adjustment is complete, press the [**A-M**] button several times until the function mode is reached.

### Adjusting the treble (Gain, Frequency)

This adjustment can only be performed when the ADF (Anti Distortion Filter) is set to "**ADF OFF**".

- Press the [**A-M**] button and select "**TREBLE GAIN**".
- Turn the [**ROTARY**] knob to adjust the treble.  
\* The factory default setting is "0". (Adjustment range: -6 to +6)
- Move the [**◀/▶**] lever to select "**TREBLE FREQ**".  
Turn the [**ROTARY**] knob to select the frequency.  
\* The factory default setting is "**12k**". (Adjustment 8 kHz/12 kHz)
- When the adjustment is complete, press the [**A-M**] button several times until the function mode is reached.

### Adjusting the balance

- Press the [**A-M**] button and select "**BALANCE**".
- Turn the [**ROTARY**] knob to adjust the balance of the left and right speakers.  
\* The factory default setting is "0". (Adjustment range: L13 to R13)
- When the adjustment is complete, press the [**A-M**] button several times until the function mode is reached.

### Adjusting the fader

- Press the [**A-M**] button and select "**FADER**".
- Turn the [**ROTARY**] knob to adjust the balance of the front and rear speakers.  
\* The factory default setting is "0". (Adjustment range: F12 to R12)
- When the adjustment is complete, press the [**A-M**] button several times until the function mode is reached.

## Radio Operations

### Listening to the radio

- Press the [**SRC**] button and select the radio mode. The frequency appears in the display.
- Press the [**BND**] button and select the radio band. Each time the button is pressed, the radio reception band changes in the following order:  
**FM1 → FM2 → FM3 → AM → FM1...**
- Move the [**◀/▶**] lever to tune in the desired station.

### Tuning

There are 3 types of tuning modes available, seek, manual and preset tuning.

### Seek tuning

- Press the [**BND**] button and select the desired band (FM or AM).  
\* If "**MANU**" is lit in the display, press and hold the [**BND**] button for 1 second or longer. "**MANU**" in the display goes off and seek tuning is now available.
- Move the [**◀/▶**] lever to automatically seek a station.  
When the lever is moved up, the station is sought in the direction of higher frequencies; if the lever is moved down, the station is sought in the direction of lower frequencies.

### Manual tuning

There are 2 ways available: Quick tuning and step tuning.

When you are in the step tuning mode, the frequency changes one step at a time. In the quick tuning mode, you can quickly tune the desired frequency.

- Press the [**BND**] button and select the desired band (FM or AM).  
\* If "**MANU**" is not lit in the display, press and hold the [**BND**] button for 1 second or longer. "**MANU**" is lit in the display and manual tuning is now available.
- Tune into a station.
  - **Quick tuning:**  
Move the [**◀/▶**] lever for 1 second or longer to tune in a station.
  - **Step tuning:**  
Move the [**◀/▶**] lever to manually tune in a station.

### Recalling a preset station

A total of 24 preset positions (6-FM1, 6-FM2, 6-FM3, 6-AM) exists to store individual radio stations in memory. Pressing the corresponding [DIRECT] button recalls the stored radio frequency automatically.

1. Press the [BND] button and select the desired band (FM or AM).
2. Press the corresponding [DIRECT] button to recall the stored station.
  - \* Press and hold one of the [DIRECT] buttons for 2 seconds or longer to store that station into preset memory.

### Manual memory

1. Select the desired station with seek tuning, manual tuning or preset tuning.
2. Press and hold one of the [DIRECT] buttons for 2 seconds or longer to store the current station into preset memory.

### Auto store

Auto store is a function for storing up to 6 stations that are automatically tuned in sequentially. If 6 receivable stations cannot be received, a previously stored station remains unoverwritten at the memory position.

1. Press the [BND] button and select the desired band (FM or AM).
2. Press and hold the [PS/AS] button for 2 seconds or longer. The stations with good reception are stored automatically to the preset channels.

### Preset scan

Preset scan receives the stations stored in preset memory in order. This function is useful when searching for a desired station in memory.

1. Press the [PS/AS] button.
2. When a desired station is tuned in, press the [PS/AS] button again to continue receiving that station.

#### Note:

- Be careful not to press and hold the [PS/AS] button for 2 seconds or longer, otherwise the auto store function is engaged and the unit starts storing stations.

### Instant station recall (ISR)

Instant station recall is a special radio preset that instantly accesses a favorite radio station at a touch of a button. The ISR function even operates with the unit in other modes.

#### ●ISR memory

1. Select the station that you wish to store in ISR memory.
2. Press and hold the [ISR] button for 2 seconds or longer.

#### ●Recalling a station with ISR

In any mode, press the [ISR] button to turn on the radio function and tune the selected radio station. "ISR" appears in the display. Press the [ISR] button again to return to the previous mode.

# CD/MP3/WMA Operations

## MP3/WMA

### What is MP3?

MP3 is an audio compression method and classified into audio layer 3 of MPEG standards. This audio compression method has penetrated into PC users and become a standard format.

This MP3 features the original audio data compression to about 10 percent of its initial size with a high sound quality. This means about 10 music CDs can be recorded on a CD-R disc or CD-RW disc to allow a long listening time without having to change CDs.

### What is WMA?

WMA is the abbreviation of Windows Media Audio, an audio file format developed by Microsoft Corporation.

#### Notes:

- If you play a file with DRM (Digital Rights Management) for WMA remaining ON, no audio is output. (The DRM indicator blinks.)
- Windows Media™, and the Windows® logo are trademarks, or registered trademarks of Microsoft Corporation in the United States and/or other countries.

#### ● To disable DRM (Digital Rights Management):

1. When using Windows Media Player 8, click on TOOLS → OPTIONS → COPY MUSIC tab, then under COPY SETTINGS, unclick the check box for PROTECT CONTENT. Then, reconstruct files.
2. When using Windows Media Player 9, click on TOOL → OPTIONS → MUSIC RECORD tab, then under Recording settings, unclick the Check box for RECORD PROTECTED MUSIC. Then, reconstruct files.

Personally constructed WMA files are used at your own responsibility.

### Precautions when creating MP3/WMA disc

#### ● Usable sampling rates and bit rates:

1. MP3: Sampling rate 11.025 kHz-48 kHz, Bit rate: 8 kbps-320 kbps / VBR
2. WMA: Bit rate 48 kbps-192 kbps

#### ● File extensions

1. Always add a file extension “.MP3” or “.WMA” to MP3 or WMA file by using single byte letters. If you add a file extension other than specified or forget to add the file extension, the file cannot be played.

2. Files without MP3/WMA data will not play. The indication “---” appears in the play time display if you attempt to play files without MP3/WMA data.

#### ● Logical format (File system)

1. When writing MP3/WMA file on a CD-R disc or CD-RW disc, please select “ISO9660 level 1, 2 or JOLIET or Romeo” as the writing software format. Normal play may not be possible if the disc is recorded on another format.
2. The folder name and file name can be displayed as the title during MP3/WMA play but the title must be within 128 single byte alphabetical letters and numerals (including an extension).
3. Do not affix a name to a file inside a folder having the same name.

#### ● Folder structure

1. A disc with a folder having more than 8 hierarchical levels will be impossible.

#### ● Number of files or folders

1. Up to 255 files can be recognized per folder. Up to 500 files can be played.
2. Tracks are played in the order that they were recorded onto a disc. (Tracks might not always be played in the order displayed on the PC.)
3. Some noise may occur depending on the type of encoder software used while recording.

### Multisession function

When a disc contains both normal CD type tracks and MP3/WMA type tracks mixedly, you can select which type of the recorded tracks to play.

#### ● Default value is “CD”.

Each time you press and hold the [BND] button for 1 second or longer, the mixed mode is switched between CD type and MP3/WMA type.

1. Types of recording that can be played are as follows.

Disc	Setting	Set to CD	Set to MP3/WMA
Mixed with CD and MP3/WMA type tracks		Play CD	Play MP3/WMA
CD type track only		Play CD	Play CD
MP3/WMA type track only		Play MP3/WMA	Play MP3/WMA

2. After making these settings, remove the disc and then reinsert it.



- When a mixed mode CD is loaded and CD is set, the track to be played first is MP3/WMA file data and no sound is heard.

**Note:**

- When playing a CCCD (Copy Control CD), set the setting to CD type. When this is set to MP3/WMA type, the CD cannot be played normally in some cases.



**Disc-In-Play function**

As long as the ignition key is turned to the ON or ACC position, this function allows you to turn the power to the unit and start playing the disc automatically when the disc is inserted even if the power is not turned on.

**Loading a CD**

- Press the [▲] button. The SLOPING CONSOLE opens.
- Insert a CD into the center of the CD SLOT with the label side facing up. The CD plays automatically after loading.

**Notes:**

- Never insert foreign objects into the CD SLOT.
- If the CD does not insert easily, there may be another CD in the mechanism or the unit may require service.
- Discs not bearing the  or  mark and CD-ROMs cannot be played by this unit.
- Some CDs recorded in CD-R/CD-RW mode may not be usable.

**Loading 8 cm compact discs**

- No adapter is required to play an 8 cm CD.
- Insert the 8 cm CD into the center of the insertion slot.

**Backup Eject function**

Pressing the [▲] button ejects the disc even if the power to the unit is not turned on.

- Press the [▲] button. Remove the disc after it is ejected.

**Note:**

- Always close the sloping console after opening it or ejecting the CD.

**⚠ CAUTION**

- Be careful not to catch your hand or fingers while closing the SLOPING CONSOLE.
- Do not try to put your hand or fingers in the disc insertion slot. Also never insert foreign objects into the slot.
- Do not insert discs where adhesive comes out from cellophane tape or a rental CD label, or discs with marks where cellophane tape or rental CD labels were removed. It may be impossible to extract these discs from the unit and they may cause the unit to break down.

**Listening to a disc already loaded in the unit**

Press the [SRC] button to select the CD/MP3/WMA mode.

When the unit enters the CD/MP3/WMA mode, play starts automatically.

If there is no disc loaded, the indication "NO DISC" appears in the display.

**Pausing play**

- Press the [▶||] button to pause play. "PAUSE" appears in the display.
- To resume CD play, press the [▶||] button again.

**Displaying CD titles**

This unit can display title data for CD-text/MP3/WMA disc and user titles input with this unit.

- Each time you press the [TITLE] button, the title changes in the following order:

**● CD-TEXT disc**

User title (disc) → CD-text title (disc) → Artist name → CD-text title (track) → User title (disc)...

**● MP3/WMA disc**

Folder → Track → Album → Artist → Title → Folder...

**● M.CATCHER**

Folder ↔ Track

## CD/MP3/WMA Operations

### Notes:

- If the CD playing is not a CD-text CD or no user title has been input, "NO TITLE" appears in the display.
- If MP3/WMA disc is not input TAG, "NO TITLE" appears in the display.
- For MP3, supports ID3 Tags V2.3 / 2.2 / 1.1 / 1.0.
- Tag displays give priority to V2.3 / 2.2.
- In the case of album Tags for WMA, the information written into the extension header is displayed.
- Only ASCII characters can be displayed in Tags.

### Selecting a track

#### ● Track-up

1. Move the [◀|▶] lever up to move ahead to the beginning of the next track.
2. Each time you move the lever up, the track advances ahead to the beginning of the next track.

#### ● Track-down

1. Move the [◀|▶] lever down to move back to the beginning of the current track.
2. Move the lever down twice to move to the beginning of the previous track.

### Fast-forward/fast-rewind

#### ● Fast-forward

Move the [◀|▶] lever up for 1 second or longer.

#### ● Fast-rewind

Move the [◀|▶] lever down for 1 second or longer.

- \* For MP3/WMA discs, it takes some time until the start of searching and between tracks. In addition, the playing time may have a margin of error.

### Folder select

This function allows you to select a folder containing MP3/WMA files and start playing from the first track in the folder.

1. Press the [DN] button to move to the previous folder.

Press the [UP] button to move to the next folder.

- \* Press the [UP] button while in the final folder to shift to the first folder.

- \* Folder without an MP3/WMA file is not selectable.

### Top function

The top function resets the CD player to the first track of the disc. Press the [BND] button to play the first track (track No. 1) on the disc.

- \* In case of MP3/WMA, the first track of a folder being played will be returned.

### Scan play

This function allows you to locate and play the first 10 seconds of all the tracks recorded on a disc.

1. Press the [SCN] button to perform scan play.
  - \* Scan play starts from the next track after the track currently being played.
2. To cancel scan play, press the [SCN] button again.

### Folder scan play

This function allows you to locate and play the first 10 seconds of the first track of all the folders on an MP3/WMA disc.

1. Press and hold the [SCN] button for 1 second or longer to perform folder scan play.
  - \* Folder scan play starts from the next track after the track currently being played.
2. To cancel folder scan play, press the [SCN] button again.

### Repeat play

This function allows you to play the current track repeatedly.

1. Press the [RPT] button to perform repeat play.
2. To cancel repeat play, press the [RPT] button again.

### Folder repeat play

This function allows you to play a track currently being played in the MP3/WMA folder repeatedly.

1. Press and hold the [RPT] button for 1 second or longer to perform folder repeat play.
2. To cancel folder repeat play, press the [RPT] button again.

### Random play

This function allows you to play all tracks recorded on a disc in a random order.

1. Press the [RDM] button to perform random play.
2. To cancel random play, press the [RDM] button again.

### Folder random play

This function allows you to play all the tracks of all the folders recorded on an MP3/WMA disc in a random order.

1. Press and hold the [RDM] button for 1 second or longer to perform folder random play.
2. To cancel folder random play, press the [RDM] button again.

### Play list mode

This function allows you to play tracks, up to latest 5 time stamps, by reading the play list information written on the disc.

1. Press and hold the [P.LIST] button for 1 second or longer to turn on or off the play list mode.
  - \* Play list play is possible only when there is a file whose extension is ".M3U" on the CD-R/RW.
  - \* Up to 5 play lists can be recognized, and up to 255 files can be recognized per play list.
2. Press the [DN] button to move to the previous play list.  
Press the [UP] button to move to the next play list.

#### Notes:

- The SCN/RPT/RDM functions cannot be used while in the play list mode.
- The title changes from folder name to play list name.

### Making a play list

1. Write desired tracks to a CD-R/RW, etc. Be sure to use alphanumeric/ASCII characters for all file names.
2. Make a play list by using a multimedia player, etc. and save the data. The file format must be M3U.
3. Again, write this play list to the CD-R/RW, etc.

#### Notes:

- When writing to a CD-R/RW, etc., be sure to use alphanumeric/ASCII characters.
- Up to 5 layers can be recognized as a list. For written play lists, latest 5 lists are recognized in the order in which they are written.
- When writing to a CD-R/RW, etc., turn off the Disc At Once function.
- When adding a play list, it is recommended to write it in the "Root" folder.

### MUSIC CATCHER

In the M.CATCHER mode, the files recorded in the built-in flash memory are played back. Operations for listening to a recording made using MUSIC CATCHER are the same as "CD/MP3/WMA Operations". For operations for recoding using MUSIC CATCHER, refer to the section "MUSIC CATCHER Operations".

# MUSIC CATCHER Operations

## Setting a recording mode

MUSIC CATCHER can be switched between 2 recording modes:

- HQ (High Quality) MODE: about 265 minutes
- LP (Long Play) MODE: about 353 minutes

\* The factory default setting is "HQ".

1. Press the [ADJ] button to switch to the adjust mode.
2. Move the [◀]/[▶] lever to select "MC-REC MODE".
3. Turn the [ROTARY] knob to select "HQ" or "LP".
4. Press the [ADJ] button to return to the previous mode.

## Notes on recording using MUSIC CATCHER:

- Recording operations are to be performed in the CD/MP3/WMA mode.
- Recordable media are CD-DAs only.
- Discs (CD-R/CD-RW) created by copying on a music recorder cannot be recorded.
- MP3/WMA discs cannot be recorded.
- Some CDs may show a subtractive time indication in the area between tracks when they are played back. A between-tracks area is not recorded in such a CD.
- In recording using MUSIC CATCHER, some amount of silent time is created between the tracks.
- If the disc contains some tracks that have been already recorded, the other tracks are recorded.
- Folder and track names are added automatically during recording.
- If the disc is not recordable, "NO REC DISC" appears on the display.
- If the disc contains some tracks previously recorded, "INCLUDED" appears on the display.
- If there is no empty folder available, "FOLDER FULL" appears on the display.
- When the memory capacity is used up, "MEMORY FULL" appears on the display and recording is canceled.
- Recording cannot be performed during SCN, RPT, and RDM. In such cases, "BUSY" appears on the display.
- The [▶||], [BND], and [SCN/RPT/RDM] buttons and the [◀]/[▶] lever are invalid during recording. When these buttons are pressed, "INVALID" appears on the display.

## Recording operation (REC function)

Recording using MUSIC CATCHER is performed in the CD/MP3/WMA mode and the following 2 recording modes are available: "TRACK REC" to record only one track currently being played back and "DISC REC" to record all tracks on the CD.

### ● TRACK REC

1. Press the [SRC] button to select the CD/MP3/WMA mode.
2. Play back a track to be recorded, and press the [REC] button to start recording. "TRACK REC" appears on the display for 2 seconds then the "REC" indicator lights on the display.
  - \* When recording is complete, the "REC" indicator goes off and "REC DONE" appears on the display for 2 seconds.

### ● DISC REC

1. Press the [SRC] button to select the CD/MP3/WMA mode.
2. Play back a CD to be recorded, and press and hold the [REC] button for 2 seconds or longer to start recording. "DISC REC" appears on the display for 2 seconds then the "REC" indicator lights on the display.
  - \* When recording is complete, the "REC" indicator goes off and "REC DONE" appears on the display for 2 seconds.

## Canceling recording

1. Press the [REC] button to cancel the recording process.
 

The display shows "CANCELED" for 2 seconds and then the playback of the CD continues.

### Notes:

- Recording also can be canceled by pressing the [SRC], [▲] or [ISR] button.
- When recording is canceled, the track that has been recorded incompletely is deleted.

## Erasing operation (ERASE function)

MUSIC CATCHER has 3 different modes for erasing files from memory.

- "TRACK ERASE" : erase only one track.
- "FOLDER ERASE" : erase the whole folder.
- "ALL ERASE" : erase all the contents of the flash memory.

1. Press the [SRC] button to select the M.CATCHER mode.

- Each time you press the [ERASE] button, the display switches in the following order:

**TRACK ERASE → FOLDER ERASE → Normal mode**

**Notes:**

- When a selected track or folder is erased, the approximate recordable time is shown (the recordable time shown varies according to the set recording mode).
- Do not turn off the power to the unit or switch the operation mode during erasing recordings.

● **TRACK ERASE**

- Press the [SRC] button to select the M.CATCHER mode.
- Play back a track to be erased, and press the [ERASE] button to select "TRACK ERASE".
- Press and hold the [▶||] button for 2 seconds or longer. The display shows "ERASING" as the track currently being played back is erased.

● **FOLDER ERASE**

- Press the [SRC] button to select the M.CATCHER mode.
- Play back any track of the folder to be erased, and press the [ERASE] button to select "FOLDER ERASE".
- Press and hold the [▶||] button for 2 seconds or longer. The display shows "ERASING" as the folder currently being played back is erased.

● **ALL ERASE**

- Press the [SRC] button to select the M.CATCHER mode.
- Press the [ERASE] button for 2 seconds or longer to select "ALL ERASE".
- Press and hold the [▶||] button for 2 seconds or longer. The display shows "ERASING" as ALL ERASE is executed.

**Remaining capacity of the memory**

By pressing the [REC] button while in the M.CATCHER mode, the remaining capacity of the flash memory can be displayed for 4 seconds as an approximate recordable time in "MM (minute): SS (second)".

The display shows "AVIL. 123:45".

**Note:**

- The recordable time shown varies according to the set recording mode

**Display Adjust Mode**

**Setting the clock**

- Press and hold the [DISP] button for 1 second or longer to switch to the display adjust mode.
- Move the [◀|/▶] lever to select "CLOCK".
- Press the [▶||] button.
- Move the lever to select the hour or the minute.
- Turn the [ROTARY] knob to set the correct time.
  - The clock is displayed in 12-hour format.
- Press the [▶||] button to store the time into memory.
- Press the [DISP] button to return to the previous mode.

**Note:**

- You cannot set the clock when it is displayed with only the ignition on. If you drain or remove the car's battery or take out this unit, the clock is reset. While setting the clock, if another button or operation is selected, the clock set mode is canceled.

**Switching the patterns of the spectrum analyzer display**

\* The factory default setting is "SRC ICON".

- Press and hold the [DISP] button for 1 second or longer to switch to the display adjust mode.
- Move the [◀|/▶] lever to select "SPE/ANALPTN".
- Turn the [ROTARY] knob to select the setting. Each time you turn the [ROTARY] knob, the setting changes in the following order:  
**1 → 2 → 3 → 4 → SRC ICON**
  - "SRC ICON" cannot be selected in the sub display.
- Press the [DISP] button to return to the previous mode.

**Setting the sensitivity of the spectrum analyzer display**

\* The factory default setting is "MID".

- Press and hold the [DISP] button for 1 second or longer to switch to the display adjust mode.
- Move the [◀|/▶] lever to select "S/A SENS".
- Turn the [ROTARY] knob to select from "LOW", "MID" or "HIGH".
- Press the [DISP] button to return to the previous mode.

## Common Operations

### Setting the speed of the spectrum analyzer display

\* The factory default setting is "HIGH".

1. Press and hold the [DISP] button for 1 second or longer to switch to the display adjust mode.
2. Move the [◀|/▶] lever to select "S/A SPEED".
3. Turn the [ROTARY] knob to select from "LOW", "MID" or "HIGH".
4. Press the [DISP] button to return to the previous mode.

### Turning the screen saver function on or off

This unit features various screen saver patterns that are exhibited across the display. If the screen savers are not desired, they can be turned off.

If the button operation is performed with the screen saver function on, the operation display corresponding to the button operation is shown for about 30 seconds and the display returns to the screen saver display.

\* The factory default setting is "RANDOM".

1. Press and hold the [DISP] button for 1 second or longer to switch to the display adjust mode.
2. Move the [◀|/▶] lever to select "SCREEN SVR".
3. Press the [▶||] button.
4. Turn the [ROTARY] knob to select the setting. Each time you turn the [ROTARY] knob, the setting changes in the following order:  
**OFF → SS1 → SS2 → SS3 → MESSAGE → RANDOM**
5. Press the [DISP] button to return to the previous mode.

### Entering MESSAGE INFORMATION

When "MESSAGE" is selected for the screen saver setting, you can change the contents of the message.

\* Up to 30 characters can be entered.

\* The factory default setting is "Welcome to Clarion".

1. Press and hold the [DISP] button for 1 second or longer to switch to the display adjust mode.
2. Move the [◀|/▶] lever to select "MSG INPUT".
3. Press the [▶||] button.
4. Move the lever to move the cursor.

5. Press the [BND] button to select a character. Each time you press the [BND] button, the character changes in the following orders:

**Capital letters → Small letters → Numbers and Symbols → Umlaut → Capital letters...**

6. Turn the [ROTARY] knob to select the desired character.
7. Repeat steps 4 to 6 to enter up to 30 characters for message.
8. Press and hold the [▶||] button for 2 seconds or longer to store the message in memory and return to the display adjust mode.
  - \* Press and hold the [BND] button for 1 second or longer to delete the message. Then press and hold the [▶||] button for 2 seconds or longer to return the message to the default setting.
9. Press the [DISP] button to return to the previous mode.

### Setting the method for title scroll

Set how to scroll in CD-TEXT, MP3/WMA TITLE.

\* The factory default setting is "ON".

1. Press and hold the [DISP] button for 1 second or longer to switch to the display adjust mode.
2. Move the [◀|/▶] lever to select "AUTO SCROLL".
3. Turn the [ROTARY] knob to select "ON" or "OFF".
  - **ON:**  
Scrolls automatically.
  - **OFF:**  
Scrolls just 1 time when the title was changed or you press and hold the [TITLE] button for 1 second or longer.
4. Press the [DISP] button to return to the previous mode.

### Setting the speed of title scroll

\* The factory default setting is "SPEED3". (Speed:1 to 6)

1. Press and hold the [DISP] button for 1 second or longer to switch to the display adjust mode.
2. Move the [◀|/▶] lever to select "SCRL SPEED".
3. Turn the [ROTARY] knob to select the setting.
4. Press the [DISP] button to return to the previous mode.

## Dimmer control

You can set the dimmer control.

- \* The factory default setting is "3". (Setting level: OFF, 1 to 5)
1. Press and hold the [DISP] button for 1 second or longer to switch to the display adjust mode.
  2. Move the [◀|▶] lever to select "DIMMER LV".
  3. Turn the [ROTARY] knob to select the setting.
  4. Press the [DISP] button to return to the previous mode.

## Adjusting the display contrast

You can adjust the display contrast to match the angle of installation of the unit.

- \* The factory default setting is "8". (Adjustment level: 1 to 16)
1. Press and hold the [DISP] button for 1 second or longer to switch to the display adjust mode.
  2. Move the [◀|▶] lever to select "CONTRAST".
  3. Turn the [ROTARY] knob to adjust the contrast.
  4. Press the [DISP] button to return to the previous mode.

## Adjust Mode

### Anti-theft indicator

The red Anti-theft indicator is a function for deterring theft. When the DCP is removed from the unit, this indicator blinks.

- \* The factory default setting is "OFF".
1. Press the [ADJ] button to switch to the adjust mode.
  2. Move the [◀|▶] lever to select "BLINK LED".
  3. Turn the [ROTARY] knob to select "ON" or "OFF".
  4. Press the [ADJ] button to return to the previous mode.

## Setting the subwoofer

\* The factory default setting is "ON".

1. Press the [ADJ] button to switch to the adjust mode.
2. Move the [◀|▶] lever to select "SUB-W".
3. Turn the [ROTARY] knob to select "ON" or "OFF".
4. Press the [ADJ] button to return to the previous mode.

## Setting the low pass filter

\* The factory default setting is "THROUGH".

1. Press the [ADJ] button to switch to the adjust mode.
2. Move the [◀|▶] lever to select "SUB-W LPF".
3. Turn the [ROTARY] knob to select the setting. Each time you turn the [ROTARY] knob, the setting changes in the following order:  
**THROUGH → 50Hz → 80Hz → 120Hz**
4. Press the [ADJ] button to return to the previous mode.

## Setting the amplifier bypass circuit

\* The factory default setting is "OFF".

1. Press the [ADJ] button to switch to the adjust mode.
2. Move the [◀|▶] lever to select "AMP CANCEL".
3. Turn the [ROTARY] knob to select "ON" or "OFF".
  - **ON:**  
Uses with connected AMP.
  - **OFF:**  
Uses with inside AMP.
4. Press the [ADJ] button to return to the previous mode.

## Common Operations

### Adjusting the auxiliary input sensitivity

Adjust the auxiliary sensitivity when the audio from an external device is difficult to hear even after adjusting the volume.

\* The factory default setting is "MID".

1. Press the [ADJ] button to switch to the adjust mode.
2. Move the [◀|▶] lever to select "AUX SENS".
3. Turn the [ROTARY] knob to select from "LOW", "MID" or "HIGH".
4. Press the [ADJ] button to return to the previous mode.

### Performing a system check

This function verifies the devices hooked up through CeNET.

1. Press the [ADJ] button to switch to the adjust mode.
2. Move the [◀|▶] lever to select "SYSTEM CHECK".
3. Press and hold the [▶||] button for 1 second or longer to start the system check.  
The digital connection configuration is automatically checked.

When the system check is complete, the display returns to the previous mode.

## Other operations

### Setting the button illumination

Press the [COLOR] button to select a color. Each time you press the [COLOR] button, the color changes in the following order:

**COLOR SCAN → Indigo Blue → Surf Blue → Silky White → Aqua Green → Fresh Green → Leaf Green → Warm Amber → Passion Red → Vivid Pink → Pale Pink → Dark Violet → Pure Purple → USER COLOR1 → USER COLOR2 → USER COLOR3 → COLOR SCAN...**

#### ● Setting COLOR SCAN mode

Selecting "COLOR SCAN", the color automatically changes.

\* The factory default setting is "COLOR SCAN".

\* Every 3 seconds the color changes to another.

#### ● Setting USER mode

\* The factory default setting is "RED 8, GREEN 8, BLUE 8".

Selecting "USER COLOR 1, 2, 3", press and hold the [COLOR] button for 1 second or longer. "RED 8" appears in the display.

1. Move the [◀|▶] lever to move the cursor.
2. Turn the [ROTARY] knob to select from 0 to 8.
3. Press and hold the [▶||] button for 2 seconds or longer to store the color in memory and return to the previous mode.

COLOR	R	G	B
Indigo Blue	0	0	8
Surf Blue	0	4	8
Silky White	8	8	7
Aqua Green	0	8	2
Fresh Green	0	8	0
Leaf Green	3	8	0
Warm Amber	8	3	0
Passion Red	8	0	0
Vivid Pink	8	0	3
Pale Pink	8	2	3
Dark Violet	3	0	8
Pure Purple	6	0	8
USER COLOR 1	8	8	8
USER COLOR 2	8	8	8
USER COLOR 3	8	8	8



## Entering titles

Titles up to 10 characters long can be stored in memory and displayed for CD, M.CATCHER, CD changer and Radio/TV stations. The number of titles that can be entered for each mode are as follows.

Mode	Number of titles
CD mode	50 titles
TV mode	20 titles
Radio mode	30 titles

CD changer mode	Number of titles
DCZ625 connected	100 titles
CDC655Tz connected	100 titles
CDC1255z connected	50 titles

1. Press the [SRC] button to select the mode you want to enter a title (Radio, CD, M.CATCHER, CD changer or TV).
2. Play a track or tune in to a radio/TV station for which you want to enter the title.
3. Do one of the following:
  - **In the CD or CD changer mode**  
Press the [TITLE] button to select "USER".
  - **In the M.CATCHER mode**  
Press the [TITLE] button to select "FOLDER".  
\* In the title display, select "FOLDER" in the upper title.
  - **In the radio or TV mode**  
Skip this step.
4. Press and hold the [TITLE] button for 1 second or longer to switch to the title input display.
5. Move the [◀|/▶] lever to move the cursor.
6. Press the [BND] button to select a character. Each time you press the [BND] button, the character changes in the following order:  
**Capital letters → Small letters → Numbers and Symbols → Umlaut → Capital letters...**
7. Turn the [ROTARY] knob to select the desired character.
8. Repeat steps 5 to 7 to enter up to 10 characters for the title.
9. Press and hold the [▶||] button for 2 seconds or longer to store the title into memory and return to the previous mode.

## Clearing titles

1. Play a track or tune in to a radio/TV station for which you want to delete the title.
2. Do one of the following:
  - **In the CD or CD changer mode**  
Press the [TITLE] button to select "USER".
  - **In the M.CATCHER mode**  
Press the [TITLE] button to select "FOLDER".  
\* In the title display, select "FOLDER" in the upper title.
  - **In the radio or TV mode**  
Skip this step.
3. Press and hold the [TITLE] button for 1 second or longer to switch to the title input display.
4. Press and hold the [BND] button for 1 second or longer to delete the title.
5. Press and hold the [▶||] button for 2 seconds or longer to store the setting and return to the previous mode.

## Cellular telephone mute

This unit requires special wiring to mute the audio signal automatically when a cellular telephone rings in the car.

\* This function is not compatible with all cellular telephones. Contact your local authorized Clarion dealer for information on proper installation and compatibility.

## AUX function

This system has an external input jack so you can listen to audio from an external device connected to this unit.

# 8. OPERATIONS OF ACCESSORIES

## CD Changer Operations

### CD changer functions

When an optional CD changer is connected through the CeNET cable, this unit controls all CD changer functions. This unit can control a total of 2 changers.

Press the [SRC] button and select the CD changer mode to start play. If 2 CD changers are connected, press the [SRC] button to select the CD changer for play.

\* If "NO MAGAZINE" appears in the display, insert the magazine into the CD changer. "DISC CHECK" appears in the display while the player loads (checks) the magazine.

\* If "NO DISC" appears in the display, eject the magazine and insert discs into each slot. Then, reinsert the magazine back into the CD changer.

#### Note:

• Some CDs recorded in CD-R/CD-RW mode may not be usable.

### ⚠ CAUTION

CD-ROM discs cannot be played from every CD changer, it's depended on the model.

### Pausing play

1. Press the [▶||] button to pause play. "PAUSE" appears in the display.
2. To resume play, press the [▶||] button again.

### Displaying CD titles

This unit can display title data for CD-text CDs and user titles input with this unit.

#### ● When connected to CDC655Tz or DCZ625

1. Each time you press the [TITLE] button, the title changes in the following order:

User title (disc) → CD-text title (disc) →  
Artist name → CD-text title (track) → User  
title (disc)...

#### Notes:

- If the CD playing is not a CD-text CD or no user title has been input, "NO TITLE" appears in the display.
- If a CD-text CD is not input its disc title or a track title, "NO TITLE" appears in the display.

### Procedure to scroll a title

Set "SCROLL" to "ON" or "OFF".

(The factory default setting is "ON". Refer to the subsection "Setting the method for title scroll" in the section "Common Operations".)

#### ● When set to "ON"

The title is automatically kept scrolling.

#### ● When set to "OFF"

To scroll just 1 time when the title was changed or you press and hold the [TITLE] button for 1 second or longer.

### Selecting a CD

Press the [UP] or [DN] button to select the desired disc.

\* If a CD is not loaded in a slot of magazine, pressing the [UP] or [DN] button can not work.

### Selecting a track

#### ● Track-up

1. Move the [◀|/▶] lever up to move ahead to the beginning of the next track.
2. Each time you move the lever up, the track advances ahead to the beginning of the next track.

#### ● Track-down

1. Move the [◀|/▶] lever down to move back to the beginning of the current track.
2. Move the lever down twice to move to the beginning of the previous track.

### Fast-forward/fast-rewind

#### ● Fast-forward

Move the [◀|/▶] lever up for 1 second or longer.

#### ● Fast-rewind

Move the [◀|/▶] lever down for 1 second or longer.

### **Scan play**

Scan play locates and plays the first 10 seconds of each track on a disc automatically. This function continues on the disc until it is cancelled.

\* The scan play is useful when you want to select a desired track.

1. Press the **[SCN]** button.
2. To cancel the scan play, press the **[SCN]** button again.

### **Disc scan play**

Disc scan play locates and plays the first 10 seconds of the first track on each disc in the currently selected CD changer. This function continues automatically until it is cancelled.

\* Disc scan play is useful when you want to select a desired CD.

1. Press and hold the **[SCN]** button for 1 second or longer.
2. To cancel disc scan play, press the **[SCN]** button again.

### **Repeat play**

Repeat play continuously plays the current track. This function continues automatically until it is cancelled.

1. Press the **[RPT]** button.
2. To cancel repeat play, press the **[RPT]** button again.

### **Disc repeat play**

After all the tracks on the current disc have been played, disc repeat play automatically re-plays the current disc over from the first track. This function continues automatically until it is cancelled.

1. Press and hold the **[RPT]** button for 1 second or longer.
2. To cancel disc repeat play, press the **[RPT]** button again.

### **Random play**

Random play selects and plays individual tracks on the disc in no particular order. This function continues automatically until it is cancelled.

1. Press the **[RDM]** button.
2. To cancel random play, press the **[RDM]** button again.

### **Disc random play**

The disc random play selects and plays individual tracks or discs automatically in no particular order. This function continues automatically until it is cancelled.

1. Press and hold the **[RDM]** button for 1 second or longer.
2. To cancel disc random play, press the **[RDM]** button again.

# TV Operations

## TV tuner functions

When an optional TV tuner is connected through the CeNET cable, this unit controls all TV tuner functions. To watch TV it requires a TV tuner and a monitor.

### Watching a TV

1. Press the **[SRC]** button and select the TV mode.
2. Press the **[BND]** button to select the desired TV band (TV1 or TV2). Each time the button is pressed, the input selection toggles between TV1 and TV2.
3. Move the [**◀**]/**[▶]** lever to tune in the desired TV station.

### Watching a video

The TV tuner features a VTR input for an external A/V source, such as a DVD player or game station.

1. Press and hold the **[ADJ]** button for 1 second or longer to select VTR.
2. To return to the TV broadcast, press and hold the **[ADJ]** button for 1 second or longer.

### TV tuning

There are 3 types of TV tuning modes available, seek, manual and preset tuning.

### Seek tuning

1. Press the **[BND]** button and select the desired TV band (TV1 or TV2).
  - \* If "MANU" is lit in the display, press and hold the **[BND]** button for 1 second or longer. "MANU" in the display goes off and seek tuning is now available.
2. Move the [**◀**]/**[▶]** lever to automatically seek a station. Move the lever up to automatically tune up the frequency band to the next available TV station; move the lever down to automatically tune down.

### Manual tuning

There are 2 ways available: Quick tuning and step tuning.

When you are in the step tuning mode, the frequency changes one step at a time. In the quick tuning mode, you can quickly tune the desired frequency.

1. Press the **[BND]** button and select the desired band (TV1 or TV2).
  - \* If "MANU" is not lit in the display, press and hold the **[BND]** button for 1 second or longer. "MANU" lights in the display and manual tuning is now available.
2. Tune into a station.

#### ● Quick tuning:

Move the [**◀**]/**[▶]** lever for 1 second or longer to tune in a station.

#### ● Step tuning:

Move the [**◀**]/**[▶]** lever to manually tune in a station.

### Recalling a preset station

A total of 12 TV stations can be stored (6-TV1 and 6-TV2). This allows you to select your favorite TV stations and store them in memory.

1. Press the **[BND]** button and select the desired TV band (TV1 or TV2).
2. To recall a stored TV station, press the desired **[DIRECT]** button to select that station.
  - \* Press and hold one of the **[DIRECT]** buttons for 2 seconds or longer to store the current station into preset memory.

### Manual memory

1. Select the desired station with seek tuning, manual tuning or preset tuning.
2. Press and hold one of **[DIRECT]** buttons for 2 seconds or longer to store the current station into preset memory.

### Auto store

Auto store selects 6 TV stations automatically and stores each one into preset memory.

If the 6 stations with good reception are available, stations previously stored in memory remain. Only stations with strong reception are stored into memory.

1. Press the **[BND]** button and select the desired TV band (TV1 or TV2).
2. Press and hold the **[PS/AS]** button for 2 seconds or longer. The stations with good reception are stored automatically to the preset channels.

### Preset scan

Preset scan allows the user to view each preset position before it automatically advances to the next preset. This function is useful for searching for a desired TV station in memory.

1. Press the **[PS/AS]** button.
2. When the desired station is found, press the **[PS/AS]** button again to remain tuned to that station.

#### Note:

- Do not press and hold the **[PS/AS]** button for 2 seconds or longer. Doing so will trigger the auto store function and start storing stations into memory.

### Setting the TV area

When you select the TV area (TV reception area), the TV tuner area setting changes.

1. Press the **[ADJ]** button to switch to the adjust mode.
2. Move the **[◀|/|▶]** lever to select “**TV AREA**”.
3. Press the **[▶||]** button.
4. Turn the **[ROTARY]** knob to select the reception area.
5. Press the **[▶||]** button.
6. Press the **[ADJ]** button to return to the previous mode.

The above operations are required when a TV tuner other than TTX7501z is connected.

### Setting the TV diver

You can change the reception setting for the TV antenna connected to the TV tuner.

\* The factory default setting depends on the TV.

1. Press the **[ADJ]** button to switch to the adjust mode.
2. Move the **[◀|/|▶]** lever to select “**TV DIVER**”.
3. Turn the **[ROTARY]** knob to select “**ON**” or “**OFF**”.
  - **ON:**  
Sets the diver setting to ON.
  - **OFF:**  
Sets the diver setting to OFF.
4. Press the **[ADJ]** button to return to the previous mode.

# 9. IN CASE OF DIFFICULTY

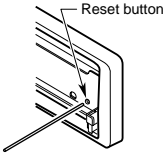
	Problem	Cause	Measure
General	Power does not turn on. (No sound is produced.)	Fuse is blown.	Replace with a fuse of the same amperage. If the fuse blows again, consult Clarion dealer.
		Incorrect wiring.	Consult Clarion dealer.
	No audio when operating the unit with amplifiers.	Amplifier turn-on lead is shorted to ground or excessive current is required.	Turn the unit off and check each wire for a possible short. If the amplifier turn-on lead shorts out, cover it with insulation such as tape.
	Nothing happens when buttons are pressed.	The microprocessor has malfunctioned due to noise, etc.	Turn off the power, then press the <b>[RELEASE]</b> button and remove the DCP. Press the reset button for about 2 seconds with a thin rod. 
	Display is not accurate.	DCP or main unit connectors are dirty.	Wipe the dirt off with a soft cloth moistened with cleaning alcohol.
	No audio.	The speaker protection circuit is operating.	<ol style="list-style-type: none"> <li>1. Check the speaker connection.</li> <li>2. Turn down sound volume. Function can also be restored by turning the power off and on again.</li> <li>3. If the sound is muted again, consult Clarion dealer.</li> </ol>
CD/MP3/WMA	No audio.	There is a disc other than a compact disc or foreign object already in place.	With the sloping console open, press and hold the <b>[▲]</b> button for 3 seconds or longer. The foreign object is forcibly ejected.
		MP3/WMA files are absent on the disc.	Write MP3/WMA files onto the disc properly.
		Files are not recognized as an MP3/WMA file.	Use MP3/WMA files encoded properly.
		File system is not correct.	Use ISO9660 level 1, 2 or JOLIET or Romeo file system.
	Sound skips or is noisy.	Disc is dirty.	Clean the disc with a soft cloth.
		Disc is heavily scratched or warped.	Replace with a disc with no scratches.

	Problem	Cause	Measure
CD/MP3/WMA	Sound is cut or skipped. Noise is generated or noise is mixed with sound.	MP3/WMA files are not encoded properly.	Use MP3/WMA files encoded properly.
	Poor sound quality in extremely cold weather or extreme humidity.	Water droplets may form on the internal lens when the car is parked in a humid place.	Let dry for about 1 hour with the power on.
	Wrong filename	File system is not correct.	Use ISO9660 level 1, 2 or JOLIET or Romeo file system.
	Play list play is not performed.	File name or extension is not correct.	Use alphanumeric/ASCII characters for MP3/WMA file name. Use <b>“.M3U”</b> for the file extension of a play list.

# 10. ERROR DISPLAYS

If an error occurs, one of the following displays is displayed.  
Take the measures described below to eliminate the problem.

	Error Display	Cause	Measure
CD/MP3/WMA	<b>ERROR 2</b>	A DISC is caught inside the CD deck and is not ejected.	This is a failure of CD deck's mechanism and consult Clarion dealer.
	<b>ERROR 3</b>	A DISC cannot be played due to scratches, etc.	Replace with a non-scratched disc.
	<b>ERROR 6</b>	A DISC is loaded upside-down inside the CD deck and cannot play.	Eject the disc then reload it properly.
M.CATCHER	<b>ERROR 7</b>	The format of the flash memory is damaged.	Execute ALL ERASE on the flash memory, and the problem is solved.
	<b>ERROR 8</b>	There is a failure with the flash memory.	Turn POWER/ACC off and then turn it on again, and the problem is solved. If not solved, executed ALL ERASE on the flash memory, and the problem is solved.
	<b>ERROR 9</b>	An error during recording, scratch on the disc, or error due to sound skips	Turn POWER/ACC off and then turn it on again, or eject the CD. The problem is solved.
CD changer	<b>ERROR 2</b>	A DISC inside the CD changer is not loaded properly.	This is a failure of CD changer's mechanism and consult Clarion dealer.
	<b>ERROR 3</b>	A DISC inside the CD changer cannot be played due to scratches, etc.	Replace with a non-scratched disc.
	<b>ERROR 6</b>	A DISC inside the CD changer cannot be played because it is loaded upside-down.	Eject the disc then reload it properly.
DVD changer	<b>ERROR 2</b>	A DISC inside the DVD changer is not loaded properly.	This is a failure of DVD mechanism and consult Clarion dealer.
	<b>ERROR 3</b>	A DISC cannot be played due to scratches, etc.	Retry or replace with a non-scratched disc.
	<b>ERROR 6</b>	A DISC inside the DVD changer cannot be played because it is loaded upside-down.	Eject the disc then reload it properly
	<b>ERROR P</b>	Parental level error	Set the correct Parental level.
	<b>ERROR R</b>	Region code error	Eject the disc and replace correct region code disc.

If an error display other than the ones described above appears, press the reset button. If the problem persists, turn off the power and consult Clarion dealer.



# 11. SPECIFICATIONS

## **FM Tuner**

Frequency Range:  
87.0 MHz to 108.0 MHz

Usable Sensitivity:  
9 dBf

50dB Quieting Sensitivity:  
15 dBf

Alternate Channel Selectivity:  
70 dB

Stereo Separation (1 kHz):  
35 dB

Frequency Response ( $\pm 3$  dB):  
30 Hz to 15 kHz

## **AM Tuner**

Frequency Range:  
531 kHz to 1629 kHz

Usable Sensitivity:  
25  $\mu$ V

## **CD Player**

System:  
Compact disc digital audio system

Usable Discs:  
Compact disc

Frequency Response ( $\pm 1$  dB):  
5 Hz to 20 kHz

Signal to Noise Ratio (1 kHz):  
100 dB

Dynamic Range (1 kHz):  
95 dB

Harmonic Distortion:  
0.01%

Channel Separation (1 kHz):  
85 dB

## **MC mode**

HQ:  
Approximately 265 minutes, 66 tracks  
(4 minutes for each)

LP:  
Approximately 353 minutes, 88 tracks  
(4 minutes for each)

### **Note:**

- Specifications and design are subject to change without notice for further improvement.

## **Audio**

Maximum Power Output:  
212 W (53 W  $\times$  4 ch)

Continuous Average Power Output:  
18 W  $\times$  4, into 4  $\Omega$ , 20 Hz to 20 kHz, 1%THD

Bass Control Action (50 Hz/80 Hz/120 Hz):  
+16 dB, -12dB

Treble Control Action (8 kHz/12 kHz):  
 $\pm 12$  dB

Line Output Level (CD 1 kHz):  
1.8 V

## **General**

Power Supply Voltage:  
14.4 V DC (10.8 to 15.6 V allowable), negative ground

Current Consumption:  
Less than 15 A, 3A

Speaker Impedance:  
4  $\Omega$  (4  $\Omega$  to 8  $\Omega$  allowable)

Weight / Source unit:  
3.52 lb. (1.6 kg)

Weight / Remote control unit:  
1.41 oz. (40 g) (including battery)

Dimensions / Source unit:  
7" (Width)  $\times$  2" (Height)  $\times$  6-1/8" (Depth)  
[178 (W)  $\times$  50 (H)  $\times$  155 (D) mm]

Dimensions / Remote control unit:  
1-3/4" (Width)  $\times$  4-7/16" (Height)  $\times$  1/2" (Depth)  
[44 (W)  $\times$  113 (H)  $\times$  13 (D) mm]

# Clarion Co., Ltd.

---

2004/11

All Rights Reserved. Copyright © 2004: Clarion Co., Ltd.

**PE-2745K**  
**280-8172-00**

Download from [Www.Somanuals.com](http://Www.Somanuals.com). All Manuals Search And Download.

## Free Manuals Download Website

<http://myh66.com>

<http://usermanuals.us>

<http://www.somanuals.com>

<http://www.4manuals.cc>

<http://www.manual-lib.com>

<http://www.404manual.com>

<http://www.luxmanual.com>

<http://aubethermostatmanual.com>

Golf course search by state

<http://golfingnear.com>

Email search by domain

<http://emailbydomain.com>

Auto manuals search

<http://auto.somanuals.com>

TV manuals search

<http://tv.somanuals.com>