

# Clarion

*Owner's manual*  
*Mode d'emploi*  
*Bedienungsanleitung*  
*Istruzioni per l'uso*  
*Gebruiksaanwijzing*  
*Manual de instrucciones*  
*Bruksanvisning*  
*Manual de instalação*

## ***DXZ858RMP***

**CD/MP3/WMA Receiver /  
CeNET & Touch Panel Control**

Récepteur CD/MP3/WMA/CeNET et écran de contrôle tactile

CD/MP3/WMA-Receiver /CeNET & Touch Panel Bedienfeld

Lettore CD/MP3/WMA / Comando pannello a tocco CeNET

CD/MP3/WMA Ontvanger /CeNET &  
Aanraakbedieningspaneel

Receptor de CD/MP3/WMA / Control en panel táctil y CeNet

CD/MP3/WMA-mottagare /CeNET & Peksärm

CD/MP3/WMA Receiver /CeNET & Touch Panel Control

**CeNET** *40*

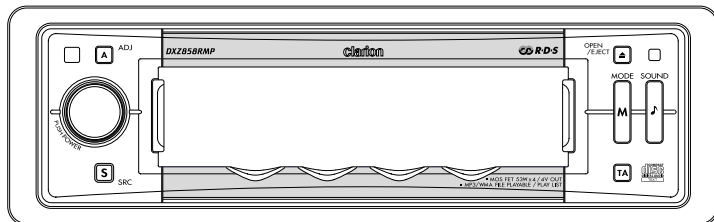

Thank you for purchasing this **Clarion** product.

- \* Please read this owner's manual in its entirety before operating this unit.
- \* After reading this manual, be sure to keep it in a handy place (e.g., glove compartment).
- \* Check the contents of the enclosed warranty card and keep it carefully with this manual.
- \* This manual includes the operating procedures of the CD changer, DAB and TV tuner connected via the CeNET cable. The CD changer and TV tuner have their own manuals, but no explanations for operating them are described.

### **CAUTIONS:**

This appliance contains a laser system and is classified as a "CLASS 1 LASER PRODUCT". To use this model properly, read this Owner's Manual carefully and keep this manual for your future reference. In case of any trouble with this player, please contact your nearest "AUTHORIZED service station". To prevent direct exposure to the laser beam, do not try to open the enclosure.

### **!CAUTIONS**

USE OF CONTROLS OR ADJUSTMENTS OR PERFORMANCE OF PROCEDURES OTHER THAN THOSE SPECIFIED IN THE OWNER'S MANUAL MAY RESULT IN HAZARDOUS RADIATION EXPOSURE.

### **ADVARSEL.**

Denne mærkning er anbragt udvendigt på apparatet og indikerer, at apparatet arbejder med laserstråler af klasse 1, hvilket betyder, at der anvendes laserstråler af svageste klasse, og at man ikke på apparatets yderside kan blive udsat for utilsigelig kraftig stråling.

**APPARATET BØR KUN ÅBNES AF FAGFOLK MED SÆRLIGT KENDESKAB TIL APPARATER MED LASERSTRÅLER!**

Indvendigt i apparatet er anbragt den her gengivne advarselsmærkning, som advarer imod at foretage sådanne indgreb i apparatet, at man kan komme til at udsætte sig for laserstråling.

### **OBS!**

Apparaten innehåller laserkomponenten som avger laserstrålning överstigande gränsen för laserklass 1.

### **VAROITUS**

Suojakoteloä si saa avata. Laite sisältää laserdiodin, joka lähettää näkymätöntä silmille vaarallista lasersäteilyä.

MODEL	<input type="text"/>	<b>Clarion</b>
<b>12V ⚡ GROUND</b>		
<b>LW</b>	<b>153-279kHz</b>	
<b>MW</b>	<b>531-1602kHz</b>	
<b>FM(UKW)</b>	<b>87.5-108MHz</b>	
This unit is designed for on-road vehicle purpose		
<b>CLASS 1 LASER PRODUCT</b>		
This product includes technology owned by Microsoft Corporation and cannot be used or distributed without a license from MSLGP.		
		PEL <input type="text"/> 286 <input type="text"/> Clarion Co., Ltd. <input type="text"/>

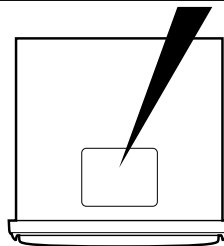

**Bottom View of Main Unit**

# Contents

<b>1. PRECAUTIONS</b> .....	<b>3</b>
Sloping Console .....	4
Handling Compact Discs .....	4
<b>2. CONTROLS</b> .....	<b>5</b>
<b>3. NOMENCLATURE</b> .....	<b>6</b>
Names of the Buttons and their Functions .....	6
Operations when External Equipment is Connected to this Unit .....	7
Touch Panel Buttons .....	8
Touch Panel Operations .....	9
<b>4. DCP</b> .....	<b>10</b>
<b>5. REMOTE CONTROL</b> .....	<b>11</b>
Inserting the Battery .....	11
Functions of Remote Control Unit Buttons .....	12
<b>6. OPERATIONS</b> .....	<b>13</b>
Basic Operations .....	13
Radio Operations .....	16
RDS Operations .....	19
CD/MP3/WMA Operations .....	24
Sound Adjustment .....	29
Common Operations .....	32
<b>7. OPERATIONS OF ACCESSORIES</b> .....	<b>41</b>
CD Changer Operations .....	41
TV Operations .....	44
Digital Radio/DAB Operations .....	47
<b>8. IN CASE OF DIFFICULTY</b> .....	<b>50</b>
<b>9. ERROR DISPLAYS</b> .....	<b>52</b>
<b>10. SPECIFICATIONS</b> .....	<b>53</b>

## 1. PRECAUTIONS

1. This unit is applicable for on-road 4 wheel vehicle purpose only. Use for tractor, fork truck, bulldozer, off road vehicle, 2 or 3 wheel motor bicycle, marine boat or other special purpose vehicle is not appropriate.
2. When the inside of the car is very cold and the player is used soon after switching on the heater, moisture may form on the disc or the optical parts of the player and proper playback may not be possible. If moisture forms on the disc, wipe it off with a soft cloth. If moisture forms on the optical parts of the player, do not use the player for about 1 hour. The condensation will disappear naturally allowing normal operation.

3. Driving on extremely bumpy roads may cause severe vibration and cause the sound to skip.

### **INFORMATION FOR USERS:**

**CHANGES OR MODIFICATIONS TO THIS PRODUCT NOT APPROVED BY THE MANUFACTURER WILL VOID THE WARRANTY.**

### **⚠ WARNING**

**For your safety, do not watch or operate the touch panel while driving.**

## Sloping Console

This unit uses a SLOPING CONSOLE to make large screen displays possible.

When you use the SLOPING CONSOLE, be sure to close it.

### ⚠ CAUTION



#### BE CAREFUL NOT TO GET YOUR FINGERS CAUGHT WHEN OPENING AND CLOSING THE SLOPING CONSOLE.

1. For safety's sake, always close the SLOPING CONSOLE before leaving this unit unused for a prolonged period or switching OFF the ignition key.

If you switch OFF the ignition key with the SLOPING CONSOLE tilted, the SLOPING CONSOLE does not close.

2. Before the SLOPING CONSOLE closes, there may be a braking sound from the safety mechanism. This is normal.
3. If you move the SLOPING CONSOLE by hand, this may start play. To correct this play, with the power for the unit ON, press the **[▲]** button to close the SLOPING CONSOLE.
4. After a disc is ejected, the SLOPING CONSOLE automatically returns to the tilted or closed state. If there is any obstruction when the SLOPING CONSOLE tries to close, the safety mechanism is triggered and the SLOPING CONSOLE returns to the open state. If this happens, remove the obstruction, then press the **[▲]** button.
5. To avoid scratching the compact disc, keep the 12 or 8 cm CD level when loading or removing it.

## Handling Compact Discs

Use only compact discs bearing the  or  mark.

Do not play heart-shaped, octagonal, or other specially shaped compact discs.

Some CDs recorded in the CD-R/CD-RW mode may not be usable.

### Handling

- Compared to ordinary music CDs, CD-R and CD-RW discs are both easily affected by high temperature and humidity and some CD-R and CD-RW discs may not be playable. Therefore, do not leave them for a long time in the car.
- New discs may have some roughness around the edges. If such discs are used, the player may not work or the sound may skip. Use a ball-point pen or the like to remove any roughness from the edge of the disc.
- Never stick labels on the surface of the compact disc or mark the surface with a pencil or pen.
- Never play a compact disc with any cellophane tape or other glue on it or with peeling off marks. If you try to play such a compact disc, you may not be able to remove it from the CD player or it may damage the CD player.

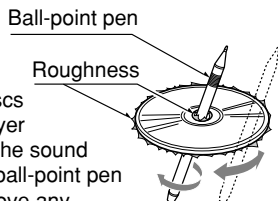

- Do not use compact discs that have large scratches, are misshapen, cracked, etc. Use of such discs may cause misoperation or damage.
- To remove a compact disc from its storage case, press down on the center of the case and lift the disc out, holding it carefully by the edges.
- Do not use commercially available CD protection sheets or discs equipped with stabilizers, etc. These may damage the disc or break the internal mechanism.

### Storage

- Do not expose compact discs to direct sunlight or any heat source.
- Do not expose compact discs to excess humidity or dust.
- Do not expose compact discs to direct heat from heaters.

### Cleaning

- To remove fingermarks and dust, use a soft cloth and wipe in a straight line from the center of the compact disc to the circumference.
- Do not use any solvents, such as commercially available cleaners, anti-static spray, or thinner to clean compact discs.
- After using special compact disc cleaner, let the compact disc dry off well before playing it.

# 2. CONTROLS

## Main unit

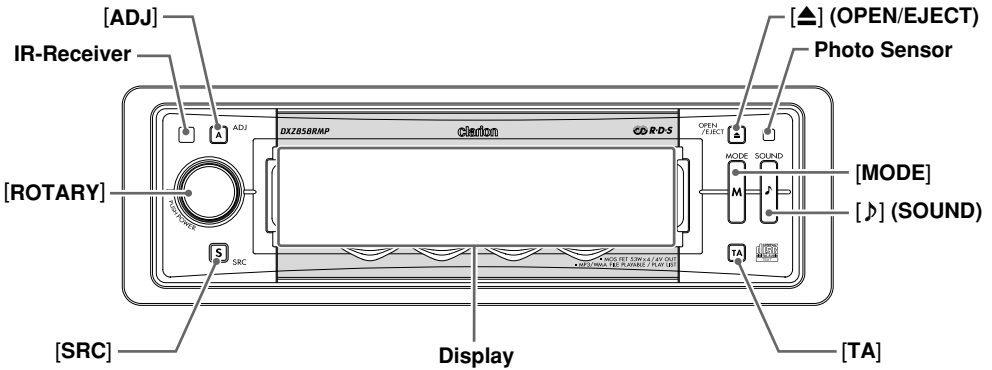

## With the SLOPING CONSOLE opened

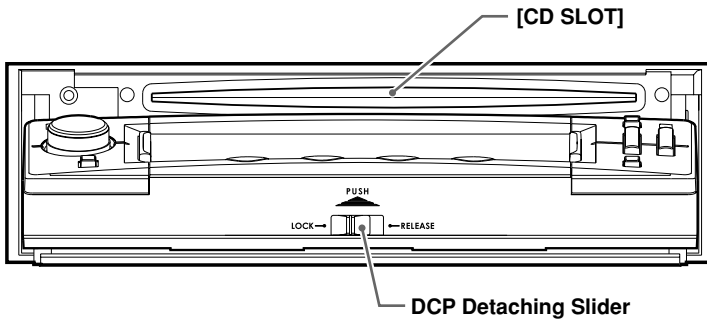

# 3. NOMENCLATURE

## *Names of the Buttons and their Functions*

### **IR-Receiver**

- Receiver for remote control unit. (Operating range: 30° in all directions)

### **[ADJ] button**

- Use this button to set or adjust the various settings in the adjust mode.

### **[▲] (OPEN/EJECT) button**

- Open/closes the control panel.  
To eject a disc, open the control panel first, and then press this button once again.

### **Photo Sensor**

- This sensor detects the brightness inside your car. When the auto-dimmer function is set to "AUTO", the brightness of the display is dimmed according to the brightness detected by this sensor.

### **[MODE] button**

- Use this button to play in scan, repeat, or random mode.
- Press and hold this button for 2 seconds or longer to switch between standard and simple operation displays.

### **[ ] (SOUND) button**

- Use this button for setting or adjusting various settings such as ADF.

### **[TA] button**

- Use this button to turn on/off TA (Traffic Announcement).

### **[SRC] button**

- Switches among sound sources as shown below.  
**Radio → (DAB) → CD/MP3 → (CD changer) → (DVD changer) → (TV) → AUX → Radio...**

#### **Note:**

*External equipment not connected with CeNET is not displayed.*

### **[ROTARY] knob**

- Press the knob to turn the power ON.
- Press the knob to turn the power OFF.
- Turn the knob to adjust the volume.

### **[CD SLOT]**

- CD insertion slot.

### **DCP Detaching Slider**

- Removes the DCP.

### **Display**

- Displays the various information that indicates the operating state of this unit such as tuning/play state and indicators.
- You can operate the display by touching or touching  the surface. (cf. page 9)

## Operations when External Equipment is Connected to this Unit

### ● When the CD/DVD changer is connected

\* For details, see the section “**CD changer operations**” (cf. page 41). For the DVD changer, refer to the Owner’s Manual provided with the DVD changer.

### ● When the TV/DAB is connected

\* For details, see the section “**TV operations**” (cf. page 44) or “**Digital Radio/DAB operations**” (cf. page 47).

# Touch Panel Buttons

## ● Standard operation display

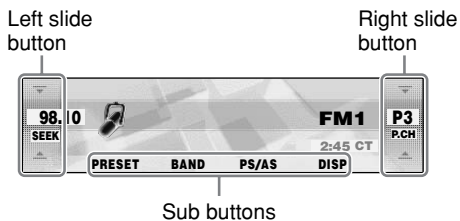

### Left slide button

- Touch this button for seek up/down or track up/down operations.
- Touch and hold this button for fast-forward/fast-rewind operations.

### Right slide button

- Touch this button for preset channel up/down, folder up/down, and disc up/down operations.

### Sub buttons

- Shows functions available in a certain context.

## ● Simple operation display

(To switch to the simple operation display, press and hold the [MODE] button for 2 seconds or longer.)

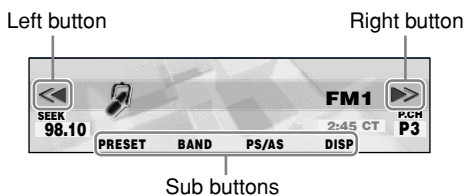

### Left button

- Touch this button for seek down or track down operations.
- Touch and hold this button for fast-rewind operation.

### Right button

- Touch this button for seek up or track up operations.
- Touch and hold this button for fast-forward operation.

### Sub buttons

- Shows functions available in a certain context.



# Touch Panel Operations

A touch panel display is used as the display on this unit. You can operate this display just by touching it with your fingertip. There are four main display operations as follows:

## Touch

Touch the display with your fingertip and take it away within 1 second. This is the most basic operation when operating the display.

## Touch and hold

Touch the display with your fingertip and hold it on the display for 1 or 2 seconds or longer. Do not move your finger while you are touching the display.

## Touch

Touch the display with your fingertip, and move your finger to the up (↑) or down (↓) with your fingertip still touching the display, and take your fingertip away within 1 second. This operation is used, for example, selecting tracks or discs.

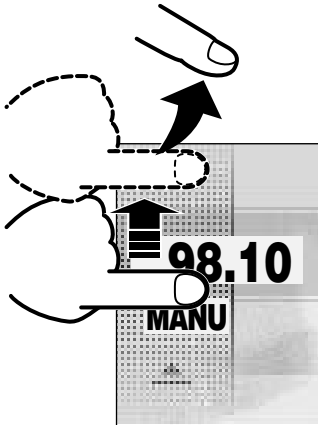

## Touch

Touch the display with your fingertip, and move your finger to the up (↑) or down (↓) with your fingertip still touching the display, and keep your fingertip on the display. The current operation continues for the time your fingertip is held on the display. This operation is used, for example, for fast-forwarding/fast-rewinding tracks.

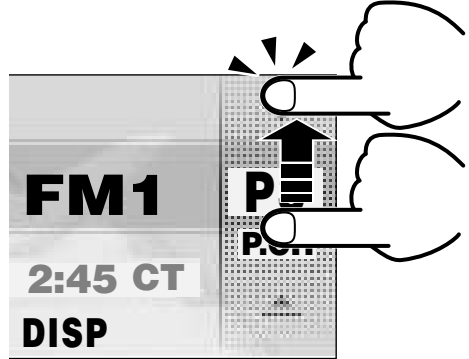

## 4. DCP

The control panel can be detached to prevent theft. When detaching the control panel, store it in the DCP (DETACHABLE CONTROL PANEL) case to prevent scratches.

We recommend taking the DCP with you when leaving the car.

### Removing the DCP

1. Turn off the power.
2. Press the [▲] button to open the DCP.
3. Move the DCP detaching slider to the "RELEASE" side.

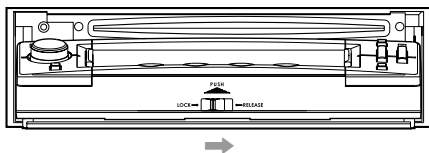

4. Push and slide the DCP upward to remove.

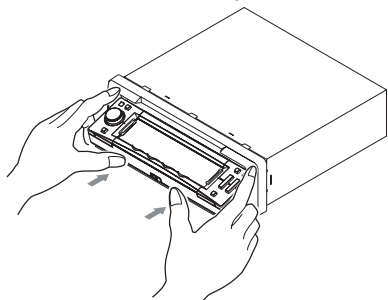

\* The SLOPING CONSOLE without DCP closes automatically in a few seconds.

### ⚠ CAUTION

- Do not try to remove or attach while driving.
- The DCP can easily be damaged by shocks. After removing it, be careful not to drop it or subject it to strong shocks.
- This DCP is equipped with a highly advanced device. In order to make the best performance, it is required to get an electrical calibration by authorised service shop. Please consult with your Clarion dealer or distributor.

### Attaching the DCP

1. Place the DCP to the SLOPING CONSOLE, adjusting the metal connectors on DCP and the SLOPING CONSOLE.
2. Press the DCP until it clicks into the SLOPING CONSOLE.

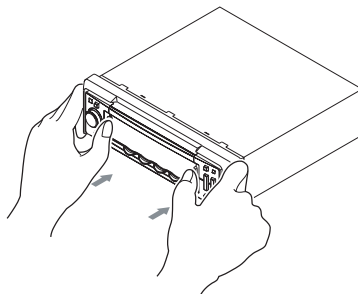

### ⚠ CAUTION

- If the slider is on the [RELEASE] side and the DCP is not locked into place, it may fall out from vibration of the car. This can break the DCP, so after removing it, either firmly reattach it on the unit or put it in its DCP case.
- The connector connecting the unit and the DCP is an extremely important part. Be careful not to damage it by pressing on it with fingernails, screwdrivers, etc.

#### Note:

- If the DCP is dirty, wipe off the dirt with a soft, dry cloth only.

# 5. REMOTE CONTROL

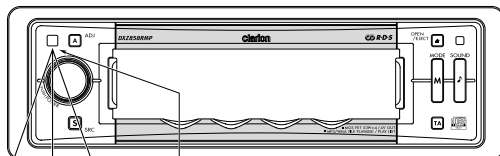

Receiver for remote control unit

Operating range : 30° in all directions

## Remote control unit

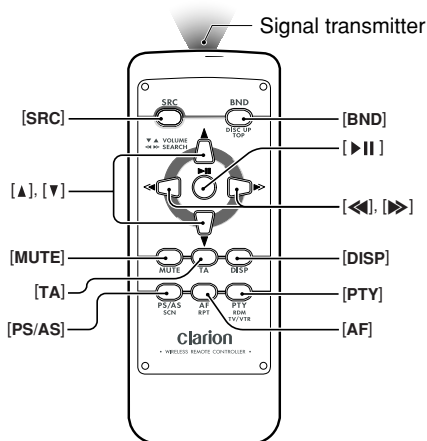

## Inserting the Battery

1. Turn over the remote control unit and slide the cover in the direction indicated by the arrow in the illustration.
2. Insert the battery (CR2025) into the insertion guides, with the printed side (+) facing upwards.
3. Press the battery in the direction indicated by the arrow so that it slides into the compartment.
4. Replace the cover and slide in until it clicks into place.

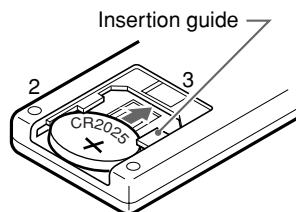
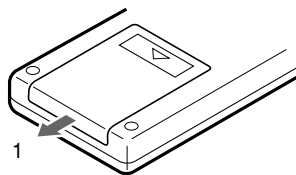

### Notes:

Misuse may result in rupture of the battery, producing leakage of fluid and resulting in personal injury or damage to surrounding materials. Always follow these safety precautions:

- Use only the designated battery .
- When replacing the battery, insert properly, with +/- polarities oriented correctly.
- Do not subject battery to heat, or dispose of in fire or water. Do not attempt to disassemble the battery.
- Dispose of used batteries properly.

## Functions of the Remote Control Unit Buttons

Mode Button	Radio (RDS)/DAB	CD/MP3/WMA	CD changer DVD changer	TV
[SRC]	Switches among radio, DAB tuner, CD/MP3/WMA, CD changer, DVD changer, TV and AUX.			
[BND]	Switches reception band.	Returns to the first track.	Moves the next disc in increasing order.	Switches reception band.
[▲], [▼]	Increases and decreases volume (in all modes).			
[◀], [▶]	Moves preset channels up and down.	Moves tracks up and down. When pressed and held for 1 second or longer: Fast-forward/fast-rewind.		Moves preset channels up and down.
[▶  ]	No function.	Switches between playback and pause.		No function.
[MUTE]	Turns mute on and off.			
[TA]	TA on and off. Press to cancel a traffic announcement broadcast during a TA interrupt.			No function.
[DISP]	Switches between the title display and the spectrum analyzer display.			
[PS/AS]	Preset scan. When pressed and held for 2 seconds or longer: Auto store.	Scan play. When pressed and held for 1 second or longer: Folder scan play (MP3/WMA disc).	Scan play. When pressed and held for 1 second or longer: Disc scan play.	Preset scan. When pressed and held for 2 seconds or longer: Auto store.
[AF]	AF function on and off. When pressed and held for 1 second or longer: REG function on and off	Repeat play. When pressed and held for 1 second or longer: Folder repeat play (MP3/WMA disc).	Repeat play. When pressed and held for 1 second or longer: Disc repeat play.	No function.
	Press to cancel an emergency broadcast during an ALARM interrupt.			No function.
[PTY]	PTY mode on and off.	Random play. When pressed and held for 1 second or longer: Folder random play (MP3/WMA disc).	Random play. When pressed and held for 1 second or longer: Disc random play.	Switches between TV and VTR.
	Press to cancel a PTY broadcast during a PTY interrupt.			No function.

\* Some of the corresponding buttons on the main unit and remote control unit have different functions.

# 6. OPERATIONS

## Basic Operations

### ⚠ CAUTION

Be sure to lower the volume before switching the unit off or the ignition key. The unit remembers its last volume setting. If you switch the power OFF with the volume up, when you switch the power back ON, the sudden loud volume may hurt your hearing and damage the unit.

## Turning ON/OFF the power

### Turning on

#### Note:

• Be careful when using this unit for a long time without running the engine. If you drain the car's battery too far, you may not be able to start the engine and this can reduce the service life of the battery.

1. Press the [ROTARY] knob.  
The mode that was previously active is displayed.

### Turning off

1. Press the [ROTARY] knob.

## CODEMATIC function

When "CODEMATIC" is set to "ON", and the power is turned ON with the DCP attached, the Touch Code display appears. Touch the display in the order that was set in the adjust mode.



For details on the CODEMATIC function, see "Using the security function" (cf. page 40).

## Selecting a mode

1. Press the [SRC] button to change the operation mode.
2. Each time you press the [SRC] button, the operation mode changes in the following order:  
**Radio → (DAB) → CD/MP3 → (CD changer) → (DVD changer) → (TV) → AUX → Radio...**  
\* External equipment not connected with CeNET is not displayed.

## Adjusting the volume

1. Turning the [ROTARY] knob clockwise increases the volume; turning it counterclockwise decreases the volume.  
\* The volume level is from 0 (minimum) to 33 (maximum).

## Switching the operation display mode

There are 2 basic operation displays: standard operation display and simple operation display.

1. Press and hold the [MODE] button for 2 seconds or longer to switch the operation display.

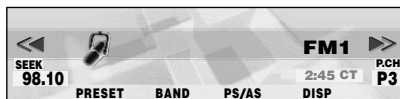

In the simple operation display, the operations of touching ↗ ↘ ↙ ↚ in the radio or CD mode display screen are not required.

Descriptions given in this manual are mainly for the standard operation display. For descriptions for operations in the simple operation display, refer to the descriptions for the screen displays in the radio mode or the CD mode.

## Switching the background

1. Touch **[DISP]**.

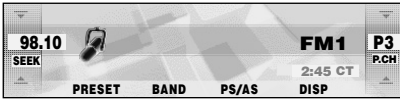

\* DISPLAY EDIT screen displays.

2. Touch on the left of the display to choose the background.



- \* The background includes 12 wallpaper images and 2 motion pictures.
- \* Choose **[SCAN]** to automatically display all the wallpaper.

### ● Background

- M01:** WRC
- M02:** Landscape
- P01:** Car and Checker Flag
- P02:** 307WRC from Two View Points
- P03:** Rally Driver
- P04:** Driving Scene
- P05:** Cube
- P06:** Bubble
- P07:** Speaker
- P08:** Digital Image1 (Disc media)
- P09:** Digital Image2 (Broadcast media such as satellite)
- P10:** Mixer
- P11:** Record Player
- P12:** Meter

3. Touch **[RTN]**.

### ■ To change wallpaper color

You can change the colors of the wallpaper (from P05 to P12).

- It can be set to both "DAY" mode and "NIGHT" mode.

1. Touch **[DISP]**.
2. Touch **[COLOR]**.



\* The **[COLOR]** is displayed only when you choose wallpaper from P05 to P12.

3. Touch on the left of the display to select **[DAY]** or **[NIGHT]**.



4. Touch on the right of the display to select the color to set.

### ● COLOR

- DARK BLUE
- IVORY
- WINE RED
- LIGHT BLUE
- GREEN

## Adjusting the spectrum analyzer

1. Touch **[DISP]**.



\* Display edit mode appears.

2. Touch **[SP/ANA]**.

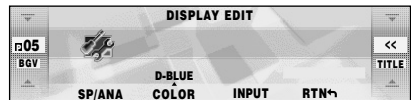

\* The display shows the spectrum analyzer mode.

3. Touch on the right of the display to select the spectrum analyzer to set.



- You can choose from four types.
- When **[SCAN]** is selected, each of them is displayed for about 10 seconds.

4. Touch **[SENS]** to select the sensitivity.

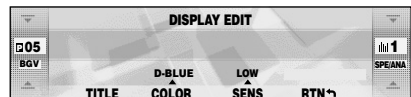

- You can choose from **[HIGH]**, **[MID]**, or **[LOW]**.

5. Touch **[RTN]**.

## Switching the title display

You can display stored information such as disc titles or track titles when playing back music in CD or CD changer mode.

1. Touch **[DISP]** while a title is shown.



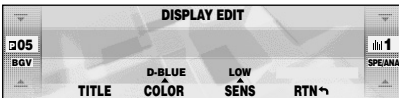

\* Display edit mode appears.

2. Touch **[TITLE]**.



\* Title edit mode appears.

3. Touch    on the right of the display to choose the kind of title to show.

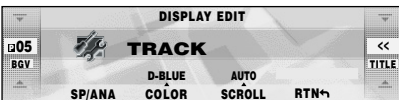

\* The title you have chosen is displayed. If it is too long to fit into the display, it automatically scrolls.

4. Touch **[SCROLL]**.
  - Select **[AUTO]** to scroll the title repeatedly.
  - Select **[ONCE]** to scroll the title only once.

### Notes:

- You cannot set the scroll options in User title.

5. Touch **[RTN]**.

### ●CD mode (MP3/WMA)

**Folder title (when using a folder) → Play list (when using a play list) → Track title → Album TAG → Artist TAG → Title TAG → Folder title (when using a folder)...**

### Notes:

- MP3 supports ID3 Tags V2.3 / 2.2 / 1.1 / 1.0.
- Tag displays give priority to V2.3 / 2.2.
- In the case of album Tags for WMA, the information written into the extension header is displayed.
- Only ASCII characters can be displayed in Tags.

## CT (Clock Time) function

The CT allows you to receive CT data sent from an RDS station and display the time. To display the CT screen, touch the centre of the display.

- If CT data is not being received, "--:-- CT" appears in the display.

### Note:

- CT data is not transmitted in some countries and by some broadcast stations. Also, in some areas, the CT data may not display accurately.

# Radio Operations

## Screen displays in the radio mode

### ● Standard operation display

The standard operation display appears by pressing the [SRC] button and selecting the radio mode.

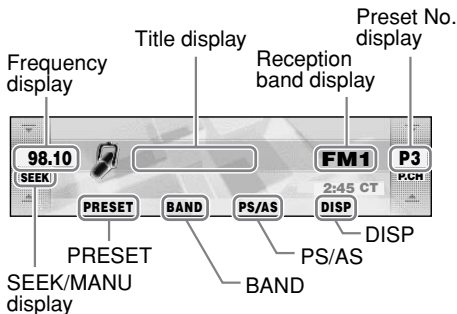

### ● Simple operation display

Pressing and holding the [MODE] button for 2 seconds or longer switches the simple operation display.

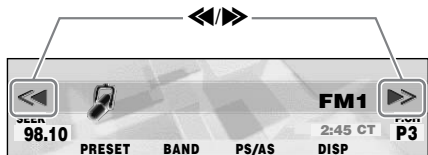

### Frequency display

The frequency currently being received is displayed.

Touching or on the left slide button in the standard operation display allows you to perform seek tuning or manual tuning.

### Preset No. display

Touching on the right slide button in the standard operation display selects a preset memory.

### Title display

Displays the name of the broadcast channel currently being received.

### Reception band display

**AM:** AM band name

**FM1:** FM band name

### PRESET

Touching this displays a preset memory No. list.

### BAND

Touching this switches the reception band. Touching and holding this for 1 second or longer switches between the manual tuning mode and the seek tuning mode.

### PS/AS

Touching this starts a preset scan.

Touching and holding this for 2 seconds or longer starts an auto store.

Touching this during the preset scan/auto scan ends the operation.

### DISP

The display contents can be changed.

### ◀▶ (only in the simple operation display)

Touching these enables seek tuning or step tuning (in the manual tuning mode).

Touching and holding these enables quick tuning (in the manual tuning mode).

## Listening to the radio

1. Press the [SRC] button to select the radio mode.

Each press of the [SRC] button switches the mode as follows:

**Radio** → (DAB) → CD/MP3 → (CD Changer) → (DVD Changer) → (TV) → AUX → Radio...

\* The mode of equipment that is not connected is not displayed.

2. Touch [BAND] to switch the reception band. Each touch of [BAND] switches the reception band as follows:

**FM1** → FM2 → FM3 → AM (MW/LW) → FM1...

## Tuning

There are 3 types of tuning mode available, seek tuning, manual tuning and preset tuning.

## Seek tuning



There are 2 types of seek tuning: DX SEEK and LOCAL SEEK.





DX SEEK can automatically tune in to receivable broadcast stations, while LOCAL SEEK can tune in to only broadcast stations with good reception sensitivity.



1. Touch **[BAND]** to select the desired band (FM or AM (MW, LW)).
2. Tune into a station.
  - \* If **"MANU"** is displayed, touch and hold **[BAND]** for 1 second or longer. Automatic tuning is possible when **"SEEK"** is displayed.
  - \* If **"TA"** is lit in the display, TP stations are automatically sought.



### DX SEEK

When    is touched on the frequency display, automatic tuning starts.

When   is touched, the station is sought in the direction of higher frequencies; when   is touched, the station is sought in the direction of lower frequencies.

\* When seek tuning starts, **"DX SEEK"** appears in the display.

### LOCAL SEEK

When    is touched on the frequency display, local seek tuning is carried out. Broadcast stations with good reception sensitivity are selected.

\* When local seek starts, **"LO SEEK"** appears in the display.



## Manual tuning

There are 2 ways available: quick tuning and step tuning.



In the step tuning mode, the frequency changes 1 step at a time. In the quick tuning mode, you can quickly tune the desired frequency.

1. Touch and hold **[BAND]** for 1 second or longer if **"SEEK"** is displayed. Manual tuning is possible when **"MANU"** is displayed.
2. Operate the frequency display to tune to a frequency on which there is a broadcast.

### ● Step tuning



Touch    on the frequency display.

### ● Quick tuning

Touch    on the frequency display. Tuning stops when you take your finger away from the panel.

## Recalling a preset station

Recalling a preset station is a function for tuning pre-stored stations.

1. Touch **[PRESET]**.  
The preset memory No. list is displayed.
2. Touch the preset memory No.
  - \* In the standard operation display, preset No. can also be tuned by touching   .

### ■ To cancel tuning

1. Touch **[RTN]**.

## Preset memory

A total of 24 preset positions (6-FM1, 6-FM2, 6-FM3, 6-AM) exists to store individual radio stations in memory.

1. Touch **[BAND]** to switch the reception band.
2. Operate the frequency display to tune to a frequency to store.
3. Touch **[PRESET]**.  
The preset memory No. list is displayed.
4. Touch and hold the preset No. to store the station to for 2 seconds or longer.  
You will hear a long beep, and the station is stored in memory.

## Auto store

Auto store is a function for storing up to 6 stations that are automatically tuned in sequentially.

1. Touch and hold **[PS/AS]** for 2 seconds or longer.  
**"A-STORE"** is displayed.
  - \* Stations with good reception are automatically searched, and are stored to preset memory (No.1 to No.6) in order from the station having the lowest frequency.

### Notes:

- When auto store is performed, stations stored to memory so far are cleared.
- When there are fewer than 6 stations with good reception in LOCAL SEEK, low frequencies are automatically returned to, and auto store is performed again by DX SEEK. If there are fewer than 6 stations even after auto store is performed twice, stations stored so far remain in memory.
- If auto store is performed in the FM bands, the stations are stored in FM3 even if FM1 or FM2 was chosen for storing stations.

### **Preset scan**

Preset scan is a function for receiving stations in the order that they are currently stored to preset No. so that broadcasts can be checked.

1. Touch **[PS/AS]**.  
“**P-SCAN**” is displayed.  
\* The currently stored stations are received in order for 7 seconds or longer each.  
Stations with poor reception are skipped, and the next station is received.

#### ■ **To cancel preset scan**

1. Touch **[PS/AS]**.  
“**P-SCAN**” display disappears and the stations that were being received when **[PS/AS]** was touched are received next.

## RDS (Radio Data System)

This unit has a built-in RDS decoder system that supports broadcast stations transmitting RDS data.

This system can display the name of the broadcast station being received (PS), and can automatically switch to the broadcast station with the best reception as you move over long distances (AF switching).

If a traffic announcement or programme type is broadcasted from an RDS station, this broadcast is received no matter what mode you are in.

Also, if EON information is received, this information enables automatic switching of other preset stations on the same network and interruption of the station being received with traffic information from other stations (TP). This function is not available in some areas.

When using the RDS function, always set the radio to the FM mode.

- AF : Alternative Frequency
- PS : Programme Service Name
- PTY : Programme Type
- EON : Enhanced Other Network
- TP : Traffic Programme
- PI : Programme Identification
- TA : Traffic Announcement
  - \* RDS interrupt does not function during AM radio reception.
  - \* When this unit receives the RDS signal, and can read PS data, PS appears in the display.

## AF function

The AF function switches to a different frequency on the same network in order to maintain optimum reception.

- The factory default setting is "ON".
- When the AF function is ON, "AF" blinks in the display.

### ■ To switch the AF function ON/OFF



1. Press the [MODE] button.
2. Touch [AF].

"AF" goes off in the display.  
To switch the AF function ON, repeat steps 1 and 2.



  - \* If the reception of the current broadcast station deteriorates, "SEARCH" appears in the display, and the radio searches for the same programme on another frequency.

### ■ AF function between RDS and DAB

When the same programme is broadcasted by both RDS and DAB, and this function is ON, this unit automatically switches to receive the broadcast with the better reception.

- This function only operates when the DAH923 or DAH913 DAB unit (Optional) is connected.
  - This factory default setting is "ON".
1. Press the [ADJ] button to set to the adjust mode.
  2. Touch [TUNER].
  3. Touch    on the left of the display to select "LINK ACT".



4. Touch    on the right of the display to select "ON" or "OFF".

**ON:**  
AF switching between DAB and RDS is enabled.

**OFF:**  
AF switching between DAB and RDS is disabled.
5. Press the [ADJ] button to return to the original mode.

## REG (Regional programme) function

When the REG function is ON, the optimum regional station can be received. When this function is OFF, the optimum station for that region is received if the regional station area switches as you drive.

- The factory default setting is “OFF”.

### Notes:

- This function is disabled when a national station such as BBC R2 is being received.
- The REG function ON/OFF setting is valid when the AF function is ON.

### ■ To switch the REG function ON/OFF

1. Press the [MODE] button.
2. Touch [REG].  
“REG” lights in the display.  
To switch the REG function OFF, repeat steps 1 and 2.

## Manually tuning a regional station in the same network

- This function is valid when the AF function is ON.
- The operation differs according to the ON/OFF setting of the REG function. When the REG function is ON, broadcasts having a perfectly matching PI code can be received. When the REG function is OFF, broadcasts of the same type of PI code can be received.

### Notes:

- This function can be used when a regional broadcast of the same network is received.
- The PI code is a coding system that is unique to each broadcast station.

1. Touch [PRESET].  
The preset memory No. list is displayed.
2. Touch the preset memory No. of the broadcast to be received.

## TA (Traffic Announcement)

When a traffic announcement broadcast starts in the TA standby mode, the traffic announcement broadcast is received as top priority regardless of the function mode so you can listen to it. Traffic programme (TP) automatic tuning is also possible.

- This function can only be used when “TP” is lit in the display. When “TP” is lit, this means that the RDS broadcast station being received has traffic announcement programmes.

### ■ To set the TA standby mode

If you press the [TA] button when only “TP” is lit in the display, “TP” and “TA” light in the display, and this unit is set to the TA standby mode until a traffic announcement is broadcast. When a traffic announcement broadcast starts, “TRA INFO” appears in the display. If you press the [TA] button while a traffic announcement broadcast is being received, the traffic announcement broadcast reception is cancelled and this unit enters the TA standby mode.

### ■ To cancel the TA standby mode

With “TP” and “TA” lit in the display, press the [TA] button. “TA” in the display goes off and the TA standby mode is cancelled.

- If “TP” is not lit, pressing the [TA] button searches for a TP station.

### ■ To search for a TP station

If you press the [TA] button when “TP” is not lit, “TA” in the display lights and this unit automatically receives a TP station.

### Note:

- When a TP station cannot be received, “TP SEEK” is displayed, and the search for the TP station is continued. When the [TA] button is pressed again, “TA” and “TP SEEK” in the display go off, and the search for the TP station ends.

## Auto store function for TP stations

You can automatically store up to 6 TP stations to preset memory. If the number of TPs that can be received is less than 6, broadcast stations already stored in memory are left without being overwritten.

1. Make sure that **"TA"** is displayed.  
If **"TA"** is not displayed, press the **[TA]** button to display **"TA"**.
  2. Touch and hold **[PS/AS]** for 2 seconds or longer.  
**"A-STORE"** is displayed and the preset No. in the auto-store operation appears on the preset No. display.
- TP stations with good reception sensitivity are stored to preset memory.
  - Even if you select FM1 or FM2, a TP station is stored to memory for FM3.

## PTY

This function enables you to listen to a broadcast of the selected programme type even if this unit is in a function mode other than radio.

- The factory default setting is **"OFF"**.
- Some countries do not yet have PTY broadcast.
- In the TA standby mode, a TP station has priority over a PTY broadcast station.

### ■ To set the PTY standby mode

1. Press the **[MODE]** button.
2. Touch **[PTY]**.  
**"PTY"** lights in the display and the PTY standby mode is turned on.  
When the selected PTY broadcast starts, the PTY item name appears in the display.



### ■ To cancel the PTY standby mode

1. Press the **[MODE]** button.
2. Touch **[PTY]**.  
**"PTY"** goes off in the display and the PTY standby mode is cancelled.

### ■ To cancel a PTY interrupt broadcast

Press the **[TA]** button during the PTY interrupt broadcast. The PTY interrupt broadcast is cancelled and this unit returns to the PTY standby mode.











## Selecting PTY

1. Press the **[MODE]** button.
2. Touch **[PTY SELECT]**.
3. Touch    on the right of the display to select PTY.  
\* Below are the factory default settings stored:

Preset number	PTY item	
	ENGLISH	Contents
P1	News	News
P2	Info	Information
P3	Pop M	Pop Music
P4	Sport	Sport
P5	Classics	Serious Classical Music
P6	Easy M	Easy Listening Music

4. The PTY select mode is cancelled automatically 7 seconds after, or touch **[RTN]**.

## PTY seek

1. Press the **[MODE]** button.
2. Touch **[PTY SELECT]**.
3. Either touch    on the right of the display, or touch **[PTY-]/[PTY+]** to select PTY.
4. Touch    on the left of the display.  
When   is touched, this unit seeks a PTY broadcast moving up the frequencies, while when   is touched it seeks moving down the frequencies.  
\* If no station with the selected PTY broadcast can be received, this unit returns to the previous mode.

PTY item				
ENGLISH	DEUTSCH	SVENSKA	FRANÇAIS	Contents
<b>News</b>	Nachricht	Nyheter	Infos	News
<b>Affairs</b>	Aktuell	Aktuellt	Magazine	Today's events
<b>Info</b>	Service	Info	Services	Information
<b>Sport</b>	Sport	Sport	Sport	Sports
<b>Educate</b>	Bildung	Utbildn	Educatif	Education
<b>Drama</b>	Hör + Lit	Teater	Fiction	Drama
<b>Culture</b>	Kultur	Kultur	Culture	Culture
<b>Science</b>	Wissen	Vetenskp	Sciences	Science
<b>Varied</b>	Unterh	Underh	Divers	Variety
<b>Pop M</b>	Pop	Pop	M Pop	Pop music
<b>Rock M</b>	Rock	Rock	M Rock	Rock music
<b>Easy M</b>	U-Musik	Lättylss	Chansons	Easy music
<b>Light M</b>	L-Musik	L klass	M Cl Lég	Light music
<b>Classics</b>	E-Musik	Klassisk	Classiq	Classics
<b>Other M</b>	- - Musik	Övrig m	Autre M	Other music
<b>Weather</b>	Wetter	Väder	Météo	Weather
<b>Finance</b>	Wirtsch	Ekonomi	Economie	Finance
<b>Children</b>	Kinder	För barn	Enfants	For children
<b>Social</b>	Soziales	Socialt	Société	Social
<b>Religion</b>	Religion	Andligt	Religion	Religion
<b>Phone In</b>	Anruf	Telefon	Forum	Phone in
<b>Travel</b>	Reise	Resor	Voyages	Travel
<b>Leisure</b>	Freizeit	Fritid	Loisirs	Leisure
<b>Jazz</b>	Jazz	Jazz	Jazz	Jazz
<b>Country</b>	Country	Country	Country	Country
<b>Nation M</b>	Landes M	Nation m	Ch pays	Nation music
<b>Oldies</b>	Oldies	Oldies	Rétro	Oldies
<b>Folk M</b>	Folklore	Folk m	Folklore	Folk music
<b>Document</b>	Feature	Dokument	Document	Documentaries

## PTY preset memory

1. Press the **[MODE]** button.
2. Touch **[PTY SELECT]**.
3. Touch **[PTY-]/[PTY+]** to select desired PTY.  
The 29 PTY types in the table below can be selected.
4. Touch **[PRESET]**.  
The PTY memory title list is displayed.
5. Touch and hold the preset No. to be stored for 2 seconds or longer.  
You will hear a long beep, and the selected PTY is stored to that preset channel memory.

## Emergency broadcast



If an emergency broadcast is received, all function mode operations are stopped, "ALARM" appears in the display, and the emergency broadcast can be heard.

### ■ To cancel an emergency broadcast



If you press the **[TA]** button, emergency broadcast reception is cancelled.

## Switching the PTY display language

You can select one of 4 languages (English, German, Swedish or French) for the PTY displayed in the display.

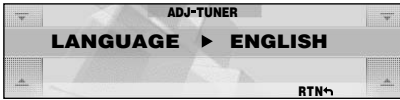
- The factory default setting is “ENGLISH”.
1. Press the **[ADJ]** button to set to the adjust mode.
  2. Touch **[TUNER]**.
  3. Touch    on the left of the display to select “LANGUAGE”.



4. Touch    on the right of the display to select the desired language.
  - \* Select one of ENGLISH, DEUTSCH (German), SVENSKA (Swedish) or FRANÇAIS (French).
5. Press the **[ADJ]** button to return to the original mode.

## Volume setting of TA, emergency broadcast (ALARM) and PTY

The volume for TA, ALARM and PTY interrupt broadcasts can be set during TA, ALARM or PTY interrupt broadcast.

- The factory default setting is “15”.

During a TA, ALARM or PTY interrupt broadcast, turn the **[ROTARY]** knob clockwise or counterclockwise to set the volume to the desired level (0 to 33).

- When the TA, ALARM or PTY interrupt broadcast ends, the volume returns to the level that was active before the interrupt broadcast.

## CD/MP3/WMA Operations

### Screen displays in the CD/MP3 mode

#### ● Standard operation display

The standard operation display appears by pressing the [SRC] button to select the CD/MP3 mode.

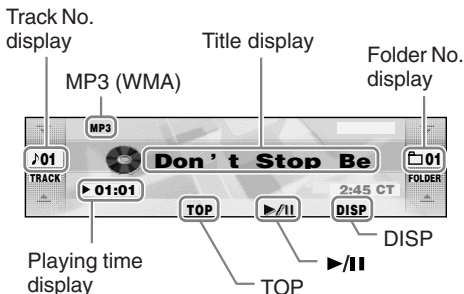

#### ● Simple operation display

Pressing and holding the [MODE] button for 2 seconds or longer switches the simple operation display.



#### Playing time display

▶00: 01: The playing time is displayed.

#### Track No. display

If or is touched, you can select the track to play, or fast-forward or fast-rewind tracks.

#### Title display

The selected title is displayed.

#### Folder No. display (in the case of MP3/WMA)

Touching selects folders.

#### TOP

Touching this starts play from the track at the top of the disc or folder being played.

#### ▶/||

Touching this pauses or resumes play.

#### DISP

The display contents can be changed.

#### ◀/▶ (only in the simple operation display)

Touching these buttons selects the track to play. Touching and holding these buttons fast-forwards or fast-rewinds tracks.

#### / (Appears only in MP3/WMA discs and the simple operation display)

Touching these buttons selects the folder to play.

## MP3/WMA

### What is MP3?

MP3 is an audio compression method and classified into audio layer 3 of MPEG standards. This audio compression method has penetrated into PC users and become a standard format.

This MP3 features the original audio data compression to about 10 percent of its initial size with a high sound quality. This means about 10 music CDs can be recorded on a CD-R disc or CD-RW disc to allow a long listening time without having to change CDs.

### What is WMA?

WMA is the abbreviation of Windows Media Audio, an audio file format developed by Microsoft Corporation.

#### Notes:

- If you play a file with DRM (Digital Rights Management) for WMA remaining ON, no audio is output. (The DRM indicator blinks.)
- Windows Media™, and the Windows® logo are trademarks, or registered trademarks of Microsoft Corporation in the United States and/or other countries.

#### ● To disable DRM (Digital Rights Management):

1. When using Windows Media Player 8, click on TOOLS → OPTIONS → COPY MUSIC tab, then under COPY SETTINGS, unclick the check box for PROTECT CONTENT. Then, reconstruct files.
2. When using Windows Media Player 9, click on TOOL → OPTIONS → MUSIC RECORD tab, then under Recording settings, unclick the Check box for RECORD PROTECTED MUSIC. Then, reconstruct files. Personally constructed WMA files are used at your own responsibility.



## Precautions when creating MP3/WMA disc

### ● Usable sampling rates and bit rates:

1. MP3: Sampling rate 11.025 kHz-48 kHz,  
Bit rate: 8 kbps-320 kbps / VBR
2. WMA: Bit rate 48 kbps-192 kbps

### ● File extensions

1. Always add a file extension “.MP3” or “.WMA” to MP3 or WMA file by using single byte letters. If you add a file extension other than specified or forget to add the file extension, the file cannot be played.
2. Files without MP3/WMA data will not play. The indication “—:—” appears in the play time display if you attempt to play files without MP3/WMA data.

### ● Logical format (File system)

1. When writing MP3/WMA file on a CD-R disc or CD-RW disc, please select “**ISO9660 level 1, 2 or JOLIET or Romeo**” as the writing software format. Normal play may not be possible if the disc is recorded on another format.
2. The folder name and file name can be displayed as the title during MP3/WMA play but the title must be within 128 single byte alphabetical letters and numerals (including an extension).
3. Do not affix a name to a file inside a folder having the same name.

### ● Folder structure

1. A disc with a folder having more than 8 hierarchical levels will be impossible.

### ● Number of files or folders

1. Up to 255 files can be recognized per folder. Up to 500 files can be played.
2. Tracks are played in the order that they were recorded onto a disc. (Tracks might not always be played in the order displayed on the PC.)
3. Some noise may occur depending on the type of encoder software used while recording.

## Multisession function

When a disc contains both CD-DA and MP3/WMA type tracks mixedly, you can select which type of the recorded tracks to play.

### ● Default value is “CD”.

1. Press the [MODE] button.
2. Touch [◀]/[▶] to go to the next page.
3. Touch [MULTI SESS].

Each touch of [MULTI SESS] toggles the MULTI SESS display between “CD” (play CD-DA) or “MP3/WMA” (play MP3/WMA).

Disc \ Setting	Set to CD	Set to MP3/WMA
Mixed with CD and MP3/WMA type tracks	Play CD	Play MP3/WMA
CD-DA	Play CD	Play CD
MP3/WMA disc	Play MP3/WMA	Play MP3/WMA

\* The multi-session selection setting is reflected the next time you load a CD.



### NOTE:

- When playing a CCCC (Copy Control CD), set the setting to CD type. When this is set to MP3/WMA type, the CD cannot be played normally in some cases.

## Loading a CD

1. Press the [▲] button.  
The control panel opens.
2. Insert the disc into the CD SLOT.  
When the disc is loaded, the control panel automatically closes after several seconds, and play starts.

### Notes:

- Never insert foreign objects into the CD SLOT.
- If the CD does not insert easily, there may be another CD in the mechanism or the unit may require service.
- Discs not bearing the  or  mark and CD-ROMs cannot be played by this unit.
- Some CDs recorded in the CD-R/CD-RW mode may not be usable.

## Loading 8 cm compact discs

- \* No adapter is required to play an 8 cm CD.
- \* Insert the 8 cm CD into the center of the CD SLOT.

## Backup eject function

You can eject a disc by pressing the [▲] button even if the engine key or ACC is at the OFF position.

### ⚠ CAUTION

**When the disc is ejected, press the [▲] button to close the control panel. If the control panel is left open, you will hear a double beep, and the control panel automatically closes.**

1. Press the [▲] button.  
The control panel opens.
2. Press the [▲] button.  
The disc is ejected.

#### Note:

- Always close the SLOPING CONSOLE after opening it or ejecting the CD.

### ⚠ CAUTION

- Be careful not to catch your hand or fingers while closing the SLOPING CONSOLE.
- Do not try to put your hand or fingers in the disc insertion slot. Also never insert foreign objects into the slot.
- Do not insert discs where adhesive comes out from cellophane tape or a rental CD label, or discs with marks where cellophane tape or rental CD labels were removed. It may be impossible to extract these discs from the unit and they may cause the unit to break down.

## Listening to a disc already loaded in the unit

1. Press the [SRC] button to select the CD/MP3 mode.  
\* Play automatically starts when the mode changes to the CD/MP3 mode.

## Pausing play

1. Touch [▶/||].

### ■ To resume play

1. Touch [▶/||] again.

## Selecting a track

When a CD-R/CD-RW recorded with an MP3 file or a WMA file is loaded, you can select only tracks recorded to the same folder by touching ↑↵↓ on the track display.

1. To listen to the next track, touch ↑↵ on the track display.
2. To listen to the previous track, touch ↓↵ twice on the track display.  
Touching ↑↵ plays the next track. If you touch ↑↵ more times, the track advances ahead to the track for the number of times you touched ↑↵ and that track is played.  
Touching ↓↵ plays the previous track. If you touch ↓↵ more times, the track moves back to the track for the number of times you touched ↓↵ and that track is played.  
\* If you touch ↓↵ twice on the track display while the start of the track is being played, the track 2 tracks back is sometimes played.

### ■ To select a folder

To select a different folder, touch ↑↵↓ on the folder display on the right.

## Play list mode

This function allows you to play tracks, up to latest 5 time stamps, by reading the play list information written on the disc.

1. Press the [MODE] button.
2. Touch [◀]/[▶] to go to the next page.
3. Touch [PLAY LIST].



The operation of selecting the play list or tracks in the play list is the same as that of selecting a folder or tracks in a folder.

- \* Play list play is possible only when there is a file whose extension is ".M3U" on the CD-R/RW.
- \* Up to 5 play lists can be recognized, and up to 255 files can be recognized per play list.

## ■ Stopping play of play list

1. Press the [MODE] button.
2. Touch [◀]/[▶] to go to the next page.
3. Touch [PLAY LIST].

### Notes:

- The SCN/RPT/RDM functions cannot be used while in the play list mode.
- The title changes from folder name to play list name.



## Making a play list

1. Write desired tracks to a CD-R/RW, etc. Be sure to use alphanumeric/ASCII characters for all file names.
2. Make a play list by using a multimedia player, etc. and save the data. The file format must be M3U.
3. Again, write this play list to the CD-R/RW, etc.

### Notes:

- When writing to a CD-R/RW, etc., be sure to use alphanumeric/ASCII characters.
- Up to 5 layers can be recognized as a list. For written play lists, latest 5 lists are recognized in the order in which they are written.
- When writing to a CD-R/RW, etc., turn off the Disc At Once function.
- When adding a play list, it is recommended to write it in the "Root" folder.

## Fast-forward/fast-rewind

1. To fast-forward, touch  on the track display.
2. To fast-rewind, touch  on the track display.

## Top function

The top function resets the CD player to the first track of the disc.

1. Touch [TOP].  
Play starts from the first track (track No.1).

## Scan play

This function allows you to locate and play the first 10 seconds of all the tracks recorded on a disc.

1. Press the [MODE] button.
2. Touch [TRACK SCAN].  
\* Scan play starts from the next track after the track currently being played.

### ■ To cancel scan play

1. Press the [MODE] button.

## Folder scan play

This function allows you to locate and play the first 10 seconds of the first track of all the folders recorders on a disc.

1. Press the [MODE] button.
2. Touch [FOLDER SCAN].  
\* Folder scan play starts from the folder following the folder that is playing.

### ■ To cancel folder scan play

1. Press the [MODE] button.

## Repeat play

This function allows you to play the current track repeatedly.

1. Press the [MODE] button.
2. Touch [TRACK RPT].

### ■ To cancel repeat play

1. Press the [MODE] button.

## Folder repeat play

This function allows you to play the current folder repeatedly.

1. Press the [MODE] button.
2. Touch [FOLDER RPT].

### ■ To cancel folder repeat play

1. Press the [MODE] button.

### ***Random play***

This function allows you to play all tracks on the disc at random.

When the disc contains 2 or more folders, all of the tracks in the folder are played at random, followed by all of the tracks in the next folder.

This is repeated for all folders.

1. Press the **[MODE]** button.
2. Touch **[TRACK RDM]**.

#### **■ To cancel random play**

1. Press the **[MODE]** button.

### ***Folder random play***

This function allows you to play all folders on the disc at random.

1. Press the **[MODE]** button.
2. Touch **[FOLDER RDM]**.

#### **■ To cancel folder random play**

1. Press the **[MODE]** button.

# Sound Adjustment

## Adjustment items

You can adjust a sound effect or tone quality to your preference.

Anti Distortion Filter (ADF) .....	Page 29
MAGNA BASS EXTEND .....	Page 29
Sub-woofer speaker volume (SW VOLUME) .....	Page 30
Bass setting (BASS) .....	Page 30
Treble setting (TREBLE) .....	Page 30
Balance (BALANCE) .....	Page 30
Fader (FADER) .....	Page 30
Filter (FILTER) .....	Page 31

## Setting the ADF

- ADF is the abbreviation of Anti Distortion Filter.

The adopted "Liveliness Enhancement Filter" and "Sound Tone Compensation" functions allow well-modulated realistic playback without affecting the characteristics of the original sound tone.

This unit is provided with 4 types of sound tone effects stored in memory. Select the one you prefer.

- ADF-1 : Suitable for genuine speakers
- ADF-2 : Suitable for separate speakers
- ADF-3 : Suitable for co-axial speakers
- USER : This setting can be adjusted by the user to his or her individual preference.

OFF : No sound effect

- The factory default setting is "OFF".

### Notes:

- As the volume changes when ADF is switched, switch ADF with the volume and "SW VOLUME" (sub-woofer) turned down as far as possible.

1. Press the [SOUND] button.
2. Touch [ADF].



3. Touch on the right of the display to select the ADF mode.



- \* Select one of "USER", "1", "2", "3", or "OFF".
4. To change the details of the ADF setting, press the [ADJ] button.
  5. Touch on the left of the display to select the desired item. Each touch of switches the adjustment item display as follows:
    - Adjustment item (when USER is selected in step 3)  
BASS → TREBLE → COMP → BASS...
    - Adjustment item (when 1 to 3 is selected in step 3)  
LEVEL → COMP → LEVEL...
  6. Touch on the right of the display to adjust the item.
    - \* "BASS" and "TREBLE" can be adjusted within the range 1 to 13.
    - \* "LEVEL" can be adjusted within the range -3 to +3.
    - \* Select either "ON" or "OFF" for "COMP".
  7. Press the [SOUND] button to return to the original mode.

## Setting MAGNA BASS EXTEND

The MAGNA BASS EXTEND does not adjust the low frequencies like the normal sound adjustment function, but emphasizes the deep bass frequencies to provide you with a dynamic sound.

- The factory default setting is "OFF".

1. Press the [SOUND] button.
2. Touch [M-BASS EX] to select "ON" or "OFF".
  - \* Each time you touch [M-BASS EX], the adjustment item changes as following order:  
OFF → ON → OFF...
3. Press the [SOUND] button to return to the original mode.

**Note:**

When "1", "2", "3", or "USER" is selected for ADF (Anti Distortion Filter), setting of MAGNA BASS EX cannot be performed.

## Adjusting the sub-woofer

- "SW VOLUME" (sub-woofer) can be adjusted only when the "SUB-WOOFER" is set to "ON" (cf. page 37).
- The factory default setting for SW VOLUME is "0".

1. Press the [SOUND] button.
2. Touch [SW VOLUME].



3. Touch  $\uparrow$   $\downarrow$  on the right of the display and adjust the item as desired.
  - \* This item can be adjusted within the range -5 to +5.
4. Press the [SOUND] button to return to the original mode.

## Adjusting the bass (Gain, Frequency, Q-curve)

This adjustment can only be performed when the ADF (Anti Distortion Filter) is set to "OFF".

1. Press the [SOUND] button.
2. Touch [BASS].
3. Touch  $\uparrow$   $\downarrow$  on the left of the display to select the item.

Each touch of  $\uparrow$   $\downarrow$  switches the adjustment items as follows:

**GAIN → FREQUENCY → Q → GAIN...**

4. Touch  $\uparrow$   $\downarrow$  on the right of the display to adjust the setting.
  - \* The factory default setting for "GAIN" is "0". (Adjustment range: -6 to +8)
  - \* The factory default setting for "FREQUENCY" is "50". (Adjustment 50/80/120Hz)
  - \* The factory default setting for "Q" is "1". (Adjustment 1/1.25/1.5/2)
5. When the adjustment is complete, press the [SOUND] button to return to the original mode.

## Adjusting the treble (Gain, Frequency)

This adjustment can only be performed when the ADF (Anti Distortion Filter) is set to "OFF".

1. Press the [SOUND] button.
2. Touch [TREBLE].
3. Touch  $\uparrow$   $\downarrow$  on the left of the display to select the item.

Each touch of  $\uparrow$   $\downarrow$  switches the adjustment items as follows:

**GAIN → FREQUENCY → GAIN...**

4. Touch  $\uparrow$   $\downarrow$  on the right of the display to adjust the setting.
  - \* The factory default setting for "GAIN" is "0". (Adjustment range: -6 to +6)
  - \* The factory default setting for "FREQUENCY" is "12k". (Adjustment 8kHz/12kHz)
5. When the adjustment is complete, press the [SOUND] button to return to the original mode.

## Adjusting balance/fader

**BALANCE:**

Adjusts the volume balance between the left and right speakers.

**FADER:**

Adjusts the volume balance between the front and rear speakers.

- The factory default setting for **BALANCE** is "0" and for **FADER** is "0".

1. Press the [SOUND] button.
2. Touch [BALANCE] or [FADER].

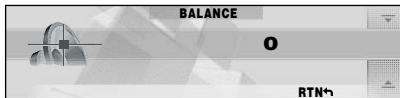

3. Touch  $\uparrow$   $\downarrow$  on the right of the display and adjust the item as desired.
  - \* "**BALANCE**" can be adjusted within the range L13 (left side emphasized) and R13 (right side emphasized).
  - \* "**FADER**" can be adjusted within the range R12 (rear side emphasized) and F12 (front side emphasized).
4. Press the [SOUND] button to return to the original mode.

## Adjusting the filter frequency

### Filter frequency

You can set a filter frequency value best suited for your speakers.

- \* This item can be adjusted only when “**SUB-WOOFER**” is set to “**ON**”.
- The factory default setting for **FILTER** is “**THROUGH**”.

### Filter adjustment

#### ● SUB-W LPF (Subwoofer Low-Pass Filter) adjustment

This filter cuts the signals above the selected frequency value.

Each touch switches the frequency value as follows:

**THROUGH → 50Hz → 80Hz → 120Hz → THROUGH...**

Select the frequency that suits your subwoofer. Set to “**THROUGH**” if you use powered subwoofers with built-in low-pass filters.

1. Press the [**SOUND**] button.
2. Touch [**FILTER**].
3. Touch  on the right of the display to select the frequency value.
  - Select from THROUGH, 50Hz, 80Hz, or 120Hz.
4. Press the [**SOUND**] button to return to the original mode.

# Common Operations

## Screen display in the TITLE INPUT

The "TITLE INPUT" screen appears when you enter a title.

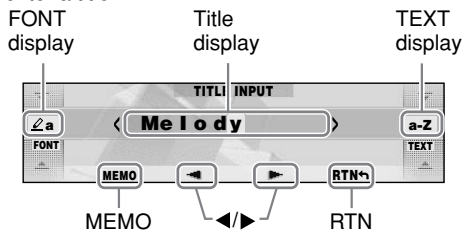

### FONT display

- A : Capital alphabet letters
- a : Small alphabet letters
- 1 : Numbers
- ♪ : Symbols
- Ä : Umlaut

### Title display

The currently entered title is displayed.

### TEXT display

Touch to select the character to enter.



Touching these buttons moves the cursor indicating input position.

### RTN

Touching this cancels entry of titles, and returns the display to the original screen.

### MEMO

Touching this stores the title that was input, and returns the display to the original screen.

## Entering titles

You can give TV stations, CDs a title up to 10 characters long. These titles can be displayed when broadcasts are received or when playing CDs.

The number of titles that can be entered is as follows:

Mode	Number of titles
CD mode	50 titles
TV mode	20 titles

CD changer mode	Number of titles
DCZ628 connected	100 titles
CDC655Tz connected	100 titles
CDC1255z connected	50 titles

1. Either receive the TV station, or play a CD for which you want to enter the title.
2. Touch [DISP].
3. Touch [INPUT].



The TITLE INPUT screen appears.

4. Touch [|] to move the cursor to indicate the input position.



\* Up to ten characters can be input.

## ⚠ CAUTION

**Pressing the reset button clears all user memories such as titles stored on this unit.**

5. Touch on [FONT] to select the type of text.

Each touch of switches the type of text as follows:

### Capital alphabet letters

(space) A B C D E F G H I J K L M N O P Q R S T U V W X Y Z

### Small alphabet letters

a b c d e f g h i j k l m n o p q r s t u v w x y z

### Numbers

0 1 2 3 4 5 6 7 8 9

### Symbols

. , ' : ; ! ? \* # \$ % & \* + - × / = ( ) < > " → ← ↑ ↓ × ÷ ☆ ★ ♥ ♦ # ♭ ♯ ♪ ♫ ♬ ♭

### Umlaut

Ä Ä Ë É Ê Ë Ì Æ Ø å ä ë é ê ï ö ü ø ø

6. Touch on [TEXT] to determine the characters to enter.
7. Repeat steps 4 to 6 to enter the title.
8. Touch [MEMO].  
You will hear a long beep, and the title is stored in memory.



## Clearing titles

1. Either receive the TV station, or play a CD file whose title you want to clear.
2. Touch **[DISP]**.
3. Touch **[INPUT]**.
4. Touch and hold **[RTN]** for 2 seconds or longer to erase the title.
5. Touch **[MEMO]**.
  - \* Erasing is performed by overwriting with a blank title.

## Cellular telephone mute

This unit requires special wiring to mute the audio signal automatically when a cellular telephone rings in the car.

- \* This function is not compatible with all cellular telephones. Contact your local authorized Clarion dealer for information on proper installation and compatibility.

## Changing settings

### Selecting setting items

1. Press the **[ADJ]** button.  
The mode changes to the adjust mode.

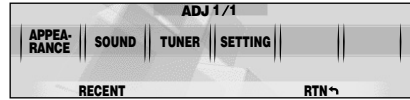

2. Touch **[APPEARANCE]**, **[SOUND]**, **[TUNER]**, or **[SETTING]**.
3. Touch on the left of the display to select the item to set.
4. When “**ENT**” is displayed at the right of the display, touch **[ENT]** to switch to the adjustment details display.
5. Touch on the right of the display to set the details.

#### ■ To return to the original mode

1. Press the **[ADJ]** button again.

#### ■ To call up the last operated item



1. Touch **[RECENT]**.

● Setting items



Main item	Sub item
APPEARANCE	<b>MSG INFO</b> • Setting the message display ON/OFF (cf. page 35)
	<b>MSG INPUT</b> • Message information input (cf. page 35)
	<b>DIMMER IN</b> • Auto-dimmer setting (cf. page 35)
	<b>DMR LEVEL</b> • Setting the dimmer level (cf. page 36)
	<b>BRIGHT</b> • Adjusting the display brightness (cf. page 36)
	<b>BLINK LED</b> • Making the LED blink when DCP is removed (cf. page 36)
	<b>BEEP</b> • Setting beep (cf. page 36)
	<b>SCROLL SPD</b> • Adjusting the scroll speed (cf. page 37)
	<b>SRC ICON</b> • Setting the source icon display (cf. page 37)
SOUND	<b>SUB WOOFER</b> • Setting sub woofer speaker ON/OFF (cf. page 37)
	<b>AMP CANCEL</b> • Setting internal amplifier use ON/OFF (cf. page 37)
TUNER	<b>LINK ACT</b> • Setting the AF function between RDS and DAB (cf. page 19)
	<b>LANGUAGE</b> • Setting the PTY screen language (cf. page 23)
	<b>TV AREA</b> • Setting the TV area (cf. page 46)
	<b>TV DIVER</b> • Setting TV diversity (cf. page 46)
SETTING	<b>AUX/TEL</b> • Setting AUX and TEL (cf. page 38)
	<b>AUX SENS</b> • Setting the portable audio (AUX) input level (cf. page 38)
	<b>TEL-SP</b> • Setting the car speaker output for the cellular phone (Optional TEL-002) (cf. page 38)
	<b>TEL-SWITCH</b> • Cellular phone interrupt setting (cf. page 39)
	<b>CALIBRATE</b> • Setting the auto-volume function (cf. page 39)
	<b>SYSTEM CHECK</b> • Performing a system check (cf. page 39)
	<b>CODEMATIC</b> • Setting security (cf. page 40)
	<b>SLIDE CONT</b> • Setting the slide direction of the slide buttons (cf. page 40)

## Displaying messages (MSG INFO)

This function allows you to display a message on the display when no operation is performed for more than 30 seconds.



- The factory default setting is "OFF".
1. Press the [ADJ] button to set to the adjust mode.
  2. Touch [APPEARANCE].
  3. Touch    on the left of the display to select "MSG INFO".



4. Touch    on the right of the display to select "ON" or "OFF".
5. Press the [ADJ] button to return to the original mode.

## Entering messages to display in message information (MSG INPUT)









- Up to 30 characters can be entered.
- The factory default setting is "Active Matrix Control System".

1. Press the [ADJ] button to set to the adjust mode.
2. Touch [APPEARANCE].
3. Touch    on the left of the display to select "MSG INPUT".



4. Touch [ENT].  
The mode changes to the message entry mode.
5. Touch [◀]/[▶] to determine the entry position.





6. Touch    on [FONT] to select the type of text.  
Each touch of    switches the type of text. For details, see page 32.
7. Touch    on [TEXT] to determine the character to enter.
8. Repeat steps 5 to 7 to enter the message.
9. Touch [MEMO].  
You will hear a long beep, and the message is stored in memory.
10. Press the [ADJ] button to return to the original mode.

## Setting the auto-dimmer (DIMMER IN)



This function allows you to dim the lighting of the display matched to the illumination or the brightness inside your car.

Select either "AUTO" (interlocked to the brightness inside your car) or "ILLUMI" (interlocked to the illumination inside your car) as the auto-dimmer setting.

- When the auto-dimmer function is set to "AUTO", the brightness of the display is dimmed according to the brightness detected by this sensor.
- Set the dimmer setting at DMR LEVEL.
- The factory default setting is "AUTO".



1. Press the [ADJ] button to set to the adjust mode.
2. Touch [APPEARANCE].
3. Touch    on the left of the display to select "DIMMER IN".





4. Touch    on the right of the display to select "AUTO" or "ILLUMI".
5. Press the [ADJ] button to return to the original mode.

## Setting the dimmer level (DMR LEVEL)

This function allows you to set how much the displayed is to be dimmed.



- The factory default setting is “3”.
1. Press the [ADJ] button to set to the adjust mode.
  2. Touch [APPEARANCE].
  3. Touch    on the left of the display to select “DMR LEVEL”.





4. Touch    on the right of the display to set the dimmer level.
  - \* Select one of OFF (dimming OFF, bright), 1 (slightly dimmed) to 5 (dark).
5. Press the [ADJ] button to return to the original mode.

## Adjusting the brightness of the display (BRIGHT)

You can adjust the brightness of the display to match the mounting angle of the unit.



- The factory default setting is “5”.
1. Press the [ADJ] button to set to the adjust mode.
  2. Touch [APPEARANCE].
  3. Touch    on the left of the display to select “BRIGHT”.





4. Touch    on the right of the display to adjust the brightness.
  - \* This setting item can be adjusted within the range 1 to 12.
  - Adjust this setting item while viewing how the appearance of the display changes.
5. Press the [ADJ] button to return to the original mode.

## Making the LED blink when DCP is removed (BLINK LED)

You can make the LED on this unit blink when the DCP is removed.



- The factory default setting is “OFF”.
1. Press the [ADJ] button to set to the adjust mode.
  2. Touch [APPEARANCE].
  3. Touch    on the left of the display to select “BLINK LED”.





4. Touch    on the right of the display to select “ON” or “OFF”.
5. Press the [ADJ] button to return to the original mode.

## Setting the beep for when buttons are operated (BEEP)

The short or long high-pitched tone you hear when a button is operated is called a “BEEP”.



- The factory default setting is “ON”.
1. Press the [ADJ] button to set to the adjust mode.
  2. Touch [APPEARANCE].
  3. Touch    on the left of the display to select “BEEP”.





4. Touch    on the right of the display to select “ON” or “OFF”.
5. Press the [ADJ] button to return to the original mode.

## Adjusting the title scroll speed (SCROLL SPD)

This feature allows you to slow down the scroll speed when the scroll speed is too fast, making it difficult to view the screen.



- The factory default setting is "SPEED 1".
1. Press the [ADJ] button to set to the adjust mode.
  2. Touch [APPEARANCE].
  3. Touch    on the left of the display to select "SCROLL SPD".





4. Touch    on the right of the display to adjust the sensitivity.
  - \* This setting item can be adjusted within the range SPEED 1 to SPEED 4.
5. Press the [ADJ] button to return to the original mode.

## Setting the source icon (SRC ICON)

You can change the source icon on the display.

- The factory default setting is "ICON".
1. Press the [ADJ] button to set to the adjust mode.
  2. Touch [APPEARANCE].
  3. Touch    on the left of the display to select "SRC ICON".





4. Touch    on the right of the display to select "ICON" or "SPE/ANA".
5. Press the [ADJ] button to return to the original mode.

## Setting speaker ON/OFF (SUB-WOOFER)

Set the sub-woofer (SUB-WOOFER) ON/OFF.

Be sure to set this setting to "OFF" when there is no sub-woofer.

- The factory default setting is "ON".
1. Press the [ADJ] button to set to the adjust mode.
  2. Touch [SOUND].
  3. Touch    on the right of the display to select "ON" or "OFF".





4. Press the [ADJ] button to return to the original mode.



## Setting internal amplifier use ON/OFF (AMP CANCEL)

Set internal amplifier use ON/OFF matched to whether or not an external amplifier is used.

Set AMP CANCEL to "ON" (internal amplifier use OFF) when an external amplifier is connected and the internal amplifier is not used.

- The factory default setting is "OFF" (internal amplifier used).
1. Press the [ADJ] button to set to the adjust mode.
  2. Touch [SOUND].
  3. Touch    on the left of the display to select "AMP CANCEL".



4. Touch    on the right of the display to select "ON" or "OFF".
5. Press the [ADJ] button to return to the original mode.



### AUX function

This system has an external RCA input so you can listen to sounds and music from external devices connected to this unit.



### Selecting AUX / TEL

You can listen to sound and music from external devices, or your telephone calls from the speakers when connected to this unit.

When TEL INT or External device is connected to this unit, you can select the TEL mode or AUX mode.

- The factory default setting is "AUX".
1. Press the [ADJ] button to set to the adjust mode.
  2. Touch [SETTING].
  3. Touch    on the left of the display to select "AUX/TEL".



4. Touch    on the right of the display to select "AUX" or "TEL".

**AUX:**

The AUX/TEL input cable is for external Audio input.

**TEL:**



The AUX/TEL input cable is for cellular phone audio input.

5. Press the [ADJ] button to return to the original mode.



### Setting the input level (AUX SENS) of portable audio (AUX mode)

This function allows you to set the input level of optional external devices connected to this unit.

- The factory default setting is "MID".
1. Press the [ADJ] button to set to the adjust mode.
  2. Touch [SETTING].

3. Touch    on the left of the display to select "AUX SENS".



4. Touch    on the right of the display to set the input level.
  - \* Select LOW, MID or HIGH.



**Notes:**

- When the input level is overloaded, "OVERLOAD" appears. Adjust AUX SENS or the input level so that "OVERLOAD" disappears.



5. Press the [ADJ] button to return to the original mode.

### Setting the car speaker output for the cellular phone (Optional TEL-002)

- To output telephone calls, set the cellular phone.
- The factory default setting is "RIGHT".

1. Press the [ADJ] button to set to the adjust mode.
2. Touch [SETTING].
3. Touch    on the left of the display to select "TEL-SP".



4. Touch    on the right of the display to select "LEFT" or "RIGHT".

**LEFT:**

Telephone calls can be heard on the front left speaker connected to this unit.

**RIGHT:**

Telephone calls can be heard on the front right speaker connected to this unit.

5. Press the [ADJ] button to return to the original mode.

## Cellular phone interrupt setting

If you connect this unit and your cellular phone with a unit (Optional, TEL-002), you can listen to your telephone calls on your car speakers.

- The factory default setting is “OFF”.
1. Press the [ADJ] button to set to the adjust mode.
  2. Touch [SETTING].
  3. Touch  on the left of the display to select “TEL-SWITCH”.



4. Touch  on the right of the display. Each time you touch, the setting changes in the following order:

**OFF → ON → MUTE → OFF...**

### OFF:

This unit continues normal operation even when the cellular phone is used.

### Note:

- When connecting a hands-free kit, make sure that the setting is ON to receive the telephone audio through the system.

### ON:

You can listen to your telephone calls from the speakers connected to this unit.

- \* When listening to your calls on your car speakers, you can adjust the volume by turning the [ROTARY] knob.

### MUTE:

The sound from this unit is muted during telephone calls.

5. Press the [ADJ] button to return to the original mode.

## Setting the auto-volume function (CALIBRATE/A-VOL SENS)

You can automatically change the volume to match your car's speed.

- The factory default setting is “LOW”.
1. Press the [ADJ] button to set to the adjust mode.
  2. Touch [SETTING].

3. Touch  on the left of the display to select “CALIBRATE”.



4. Accelerate to a speed of 50 km.
5. When you reach 50 km, touch [START]. Calibration is executed. After 2 seconds or longer, you will hear a long beep, and “SUCCESSFUL” will appear on the display. If you hear a short beep, this indicates that calibration failed. Repeat the procedure from step 4.
6. Next, adjust the sensitivity. Touch [SETTING].
7. Touch  on the left of the display to select “A-VOL SENS”.



8. Touch  on the right of the display. Each time you touch, the setting changes in the following order: **OFF** (no change in volume) → **LOW** (change in volume: small) → **MID-LOW** → **MID** → **MID-HIGH** → **HIGH** (change in volume: large) ...
9. Press the [ADJ] button to return to the original mode.

## Performing a system check (SYSTEM CHECK)

This function allows you to perform a system check when an external equipment is connected to this unit.

1. Press the [ADJ] button to set to the adjust mode.
2. Touch [SETTING].
3. Touch  on the left of the display to select “SYSTEM CHECK”.



4. Touch **[START]**.  
The confirmation display appears.
5. Touch **[OK]**.

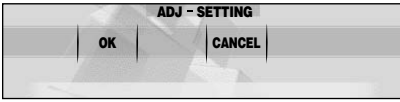

After this operation, the display returns to the original mode.

## Using the security function (CODEMATIC)

This function prevents persons who do not know the touch sequence from easily operating this unit. The Touch Code display appears when DCP is attached and the power is turned ON with "CODEMATIC" set to "ON".

If you touch the display in this screen in the preset order, "SUCCESSFUL" is displayed and the power is turned OFF.

When the power is next turned ON, the Touch Code display does not appear, and the main display in the radio mode or CD mode is displayed.

- The factory default setting is "OFF".
1. Press the **[ADJ]** button to set to the adjust mode.
  2. Touch **[SETTING]**.
  3. Touch on the left of the display to select "CODEMATIC".



2 types of items are displayed for "CODEMATIC", items for which "ON" or "OFF" is displayed at the right of the screen, and items for which "INPUT" is displayed at the right of the screen. Here, select the item for which "ON" or "OFF" is displayed at the right of the display.

4. Touch on the right of the display to select "ON" or "OFF".
5. Touch on the left of the display to select "CODEMATIC".



- Here, select the item for which "INPUT" is displayed at the right of the display.
6. Touch **[INPUT]**.  
The Touch Code display appears.
  7. Enter the touch code.  
\* Touch **[1]** to **[4]** at the bottom of the display at random. You can also repeatedly touch the same number.

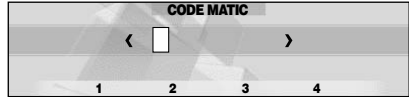

When you touch 4 times, and 4 indicators light, you will hear a long beep, and the original mode is returned to.

### ■ To cancel CODEMATIC

If you have forgotten the touch order, either touch **[4]**, **[1]**, **[3]** and then **[2]** in that order, or press **[SCN]** on the remote control unit.

## Setting the slide direction of the slide buttons (SLIDE CONT)

This function allows you to set the direction of the left and right slide buttons.

- The factory default setting is "UP → +".
1. Press the **[ADJ]** button to set to the adjust mode.
  2. Touch **[SETTING]**.
  3. Touch on the left of the display to select "SLIDE CONT".



4. Touch on the right of the display to select "UP → +" or "DOWN → +".
5. Press the **[ADJ]** button to return to the original mode.



# 7. OPERATIONS OF ACCESSORIES

## CD Changer Operations

### CD changer

When an optional CD changer is connected through the CeNET cable, this unit can control CD changer operations. This unit can be connected to a total of 2 CeNET-wired CD changers.

#### ■ When 2 CD changers are connected

Press the [SRC] button to select the changer connected to this unit. (Each press of the [SRC] button switches the changer.)

- If the CD changer does not contain a magazine, “NO MAGAZINE” is displayed, and if the magazine does not contain a CD, “NO DISC” is displayed.
- For details on the title display, see “Switching the title display” (cf. page 15).

### Screen displays in the changer mode

#### ● Standard operation display

The standard operation display appears by pressing the [SRC] button to select changer modes.

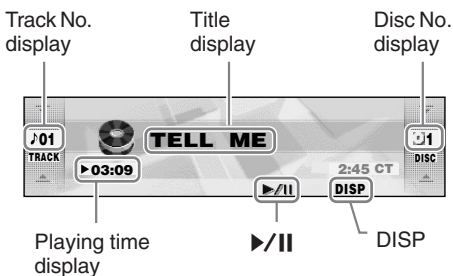

#### ● Simple operation display

Pressing and holding [MODE] button for 2 seconds or longer switches the simple operation display.



#### Playing time display

▶00:01: The playing time is displayed.

#### Track No. display

Touching or allows you to select the track to play, or fast-forward/fast-rewind tracks.

#### Title display

The selected title is displayed.

#### Disc No. display

Touching selects discs.

#### ▶/||

Touching this pauses or resumes play.

#### DISP

The display contents can be changed.

#### ◀◀/▶▶ (only in the simple operation display)

Touching these selects the track to play.

Touching and holding these fast-forwards/fast-rewinds tracks.

#### / (Only in the simple operation display)

Touching these buttons selects the disc to play.

## ⚠ CAUTION

**CD-ROM discs cannot be played from every CD changer. This depends on the model.**

#### Note:

- Some CDs recorded in the CD-R/CD-RW mode may not be usable.

### Selecting the changer mode

1. Press the [SRC] button to select the changer mode.

\* Each time you press the [SRC] button, the display switches as follows:

**Radio → (DAB) → CD/MP3 → (CD changer) → (DVD changer) → (TV) → AUX → Radio...**

- \* The mode of equipment that is not connected is not displayed. Play starts automatically when the mode changes to the changer mode.

## Pausing play

1. Touch /III.

### ■ To resume play

1. Touch /III again.

## Selecting a CD

1. Touch on the disc No. display to select a disc.  
Play starts.  
\* If magazine does not contain the disc you selected, the No. for that disc is not displayed.

## Selecting a track

1. To listen to the next track, touch on the track display.
2. To listen to the previous track, touch twice on the track display.  
Touching plays the next track. If you touch more times, the track advances ahead to the track for the number of times you touched and that track is played.  
Touching plays the previous track. If you touch more times, the track moves back to the track for the number of times you touched and that track is played.  
\* If you touch twice on the track display while the start of the track is being played, the track 2 tracks back is sometimes played.

## Fast-forward/fast-rewind

1. To fast-forward, touch on the track display.
2. To fast-rewind, touch on the track display.

## Scan play

Scan play locates and plays the first 10 seconds of each track on a disc automatically. This function continues on the disc until it is canceled.

The scan play function is useful when you want to select a desired track.

1. Press the [MODE] button.

2. Touch [TRACK-SCAN].  
\* Scan play starts from the next track after the track currently being played.

### ■ To cancel scan play

1. Press the [MODE] button.

## Disc scan play

Disc scan play locates and plays the first 10 seconds of the first track on each disc in the currently selected changer. This function continues automatically until it is canceled.

Disc scan play is useful when you want to select a desired disc.

1. Press the [MODE] button.
2. Touch [DISC SCAN].  
\* Disc scan play starts from the next disc after the disc currently being played.

### ■ To cancel disc scan play

1. Press the [MODE] button.

## Repeat play

Repeat play continuously plays the current track. This function continues automatically until it is canceled.

1. Press the [MODE] button.
2. Touch [TRACK RPT].

### ■ To cancel repeat play

1. Press the [MODE] button.

## Disc repeat play

After all the tracks on the current disc have been played, disc repeat play automatically replays the current disc over from the first track. This function continues automatically until it is canceled.

1. Press the [MODE] button.
2. Touch [DISC RPT].

### ■ To cancel disc repeat play

1. Press the [MODE] button.

## ***Random play***

Random play selects and plays individual tracks on the disc in no particular order. This function continues automatically until it is canceled.

1. Press the **[MODE]** button.
2. Touch **[TRACK RDM]**.

### **■ To cancel random play**

1. Press the **[MODE]** button.

## ***Disc random play***

The disc random play selects and plays individual tracks or discs automatically in no particular order. This function continues automatically until it is canceled.

1. Press the **[MODE]** button.
2. Touch **[DISC RDM]**.

### **■ To cancel disc random play**

1. Press the **[MODE]** button.

# TV Operations

## TV tuner function

When an optional TV tuner is connected through the CeNET cable, this unit controls all TV tuner functions. To watch TV, you need a TV tuner and a monitor.

## Screen displays in the TV mode

### ● Standard operation display

The standard operation display appears by pressing the [SRC] button to select the TV mode.

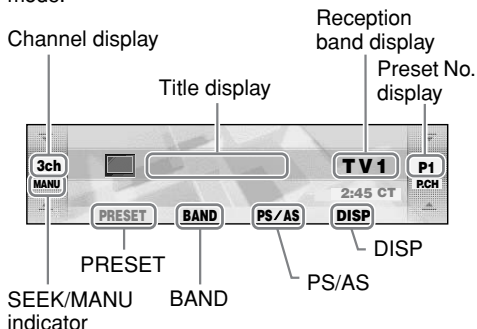

### ● Simple operation display

Pressing and holding the [MODE] button for 2 seconds or longer switches the simple operation display.

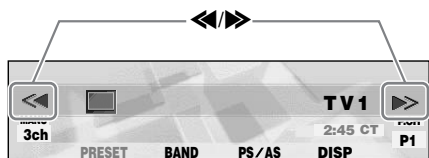

### Channel display

**3ch**: The channel currently being received is displayed.

Touching  $\uparrow$   $\downarrow$  or  $\leftarrow$   $\rightarrow$  in the standard operation display allows you to perform seek tuning or manual tuning.

### Title display

The name of the station currently being received is displayed.

**VTR** : In video mode

Touching these switches the display.

### Reception band display

**TV1** : Band name

### Preset No. display

Touching  $\uparrow$   $\downarrow$  on the right slide button in the standard operation display selects a preset memory.

Touching [PRESET] displays the preset memory number list.

### PS/AS

Touching this starts a preset scan.

Touching and holding this for 2 seconds or longer starts an auto store.

Touching this during the preset scan/auto scan ends the operation.

### BAND

Touching this switches the reception band.

Touching and holding this for 1 second or longer toggles between the manual tuning mode and the seek tuning mode.

### ◀▶ (only in the simple operation display)

Touching these buttons enables seek tuning or step tuning (in the manual tuning mode).

Touch and holding these buttons enables quick tuning (in manual tuning mode).

### DISP

The display contents can be changed.

## Selecting the TV mode

1. Press the [SRC] button to select the TV mode.

Each press of the [SRC] button switches the mode as follows:

**Radio** → (DAB) → CD/MP3 →  
(CD changer) → (DVD changer) → (TV) →  
**AUX** → Radio...

\* The mode of equipment that is not connected is not displayed.



## Switching the reception band

1. Touch [BAND] to switch the reception band. Each touch of [BAND] switches the reception band.



**TV1** → **TV2** → **TV1**...

## Seek tuning

Seek tuning is a function for automatically tuning stations with good reception.

1. Touch and hold **[BAND]** for 1 second or longer while **"MANU"** is displayed. Automatic tuning is possible when **"SEEK"** is displayed.
2. Touch    on the channel display. **"SEEK UP/SEEK DOWN"** is displayed, and tuning starts. Tuning automatically stops at stations with good reception.

### ■ To cancel tuning

1. Touch    on the channel display again.



## Manual tuning

There are 2 ways available: quick tuning and step tuning.



In the step tuning mode, the frequency changes 1 step at a time. In the quick tuning mode, you can quickly tune the desired frequency.

1. Touch and hold **[BAND]** for 1 second or longer if **"SEEK"** is displayed. Manual tuning is possible when **"MANU"** is displayed.
2. Operate the channel display to tune to a channel on which there is a broadcast.

### ● Step tuning



Touch    on the channel display.

### ● Quick tuning

Touch    on the channel display. Tuning stops when you take your finger away from the panel.

## Recalling a preset station

This function allows the user to select a preset station.

1. Touch **[PRESET]**.  
The preset memory No. list is displayed.
2. Touch the preset memory No.  
\* The station can also be tuned by touching    in the standard operation display.

### ■ To cancel tuning

1. Touch **[RTN]**.

## Preset memory

A total of 12 TV stations can be stored (6-TV1 and 6-TV2). This allows you to select your favorite TV stations and store them in memory for later recall.

1. Touch **[BAND]** to switch the reception band.
2. Operate the channel display to select the station to store to.
3. Touch **[PRESET]**.  
The preset memory No. list is displayed.
4. Touch and hold the preset No. to store for 2 seconds or longer.  
You will hear a long beep, and the station is stored in memory.

## Auto store

Auto store selects 6 TV stations automatically and stores each one into preset memory.

1. Touch and hold **[PS/AS]** for 2 seconds or longer.  
**"A-STORE"** appears on the display.  
\* Stations with good reception are automatically searched, and are stored to preset memory (No.1 to No.6) in order from the station having the lowest frequency.

### Notes:

- When auto store is performed, stations stored to memory so far are cleared.
- When there are fewer than 6 stations with good reception, low frequencies are automatically returned to, and auto store is performed again. If there are fewer than 6 stations even after auto store is performed twice, stations stored so far remain in memory.

## Preset scan

Preset scan is a function for receiving stations in the order that they are currently stored to preset No. so that broadcasts can be checked.

1. Touch **[PS/AS]**.  
**"P-SCAN"** appears on the display.  
\* The currently stored stations are received in order for 7 seconds or longer each. Stations with poor reception are skipped, and the next station is received.

## ■ To cancel the preset scan

1. Touch **[PS/AS]**.  
 "P-SCAN" disappears, and the stations that were being received when **[PS/AS]** was touched are received next.



## Watching a video

The TV tuner has a VTR input terminal to which 1 external device can be connected. Connect a 12 V video cassette player (VCP) or video cassette recorder (VCR) to the TV tuner input terminal.



1. Press the **[MODE]** button.
2. Touch **[TV/VTR]**.  
 \* Every time you touch this, the function switches between TV and VTR.

## Setting the TV area (TV AREA)

When you select the TV area (TV reception area), the TV tuner area setting changes.

- The factory default setting is "GERMANY".
1. Press the **[ADJ]** button to set the adjust mode.
  2. Touch **[TUNER]**.
  3. Touch    on the left of the display to select "TV AREA".





4. Touch    on the right of the display to select the area.
5. Press the **[ADJ]** button to return to the previous mode.



## Setting the TV Diver

You can change the reception setting for the TV antenna connected to the TV tuner.

- Set this item to "OFF" when a TV diversity antenna is not in use.
  - The factory default setting is "ON".
1. Press the **[ADJ]** button to set to the adjust mode.
  2. Touch **[TUNER]**.

3. Touch    on the left of the display to select **[TV DIVER]**.



4. Touch    on the right of the display to select **[ON]** or **[OFF]**.
5. Press the **[ADJ]** button to return to the original mode.

## DAB control function

When a CeNET cable is used to connect a DAB (Optional, DAH913 or DAH923), all functions can be operated.



## Listening to the DAB station

1. Press the **[SRC]** button to select the DAB mode.



### Notes:

- The display shown in the normal reception mode and the preset reception mode is the same as that when a DAB station is received.
- The number of programmes and broadcasting times depend on the DAB station.
- When the strength of DAB signals is weak, audio output is muted.



## Seek tuning

1. Press the **[SRC]** button to select the DAB mode.
2. Touch and hold **[BAND]** for 1 second or longer if **"MANU"** is displayed. Seek tuning is possible when **"SEEK"** is displayed.
3. Touch    on the left of the display. **"DAB"** lights up in the display when the main unit receives a DAB station.
  - \* The main unit stops the seek tuning when it cannot find a DAB station. The display returns to the original mode.

## Manual tuning

1. Press the **[SRC]** button to select the DAB mode.
2. Touch and hold **[BAND]** for 1 second or longer if **"SEEK"** is displayed. Manual tuning is possible when **"MANU"** is displayed.
3. Touch    on the left of the display to tune the station.
  - \* If no operation is performed for more than 7 seconds, manual tuning is cancelled and the display returns to the seek turning mode.

## Switching programmes

1. Press the **[SRC]** button to select the DAB mode.
2. Touch    on the left of the display to switch programmes in the DAB station.

### Note:

- The programme name may be the same depending on the DAB programme.

## Programme scan

This function scans through each receivable programme in a DAB station being received for 10 seconds sequentially. This is useful when you want to search for a desired programme.

1. Press the **[SRC]** button to select the DAB mode.
2. Touch **[S-SCAN]**.  
**"S-SCAN"** lights up and this unit starts scanning each programme for 10 seconds sequentially. Each time the main unit scans, the programme name is shown in the display.
3. To stop programme scan when a desired programme is tuned in touch **[S-SCAN]**.

## Manual memory

The main unit has a manual memory function for DAB programmes. Up to 18 programmes (6 programmes each) can be preset to the preset buttons.



### [M1], [M2] and [M3]

1. Press the **[SRC]** button to select the DAB mode.
2. Touch **[BAND]** to select any one shown above.
3. Touch **[PRESET]**. The preset memory No. list is displayed.
4. Touch and hold the preset No. to be stored for 2 seconds or longer. You will hear a long beep, and the station is stored to memory. If you hear a short beep, the station is not stored to memory. Repeat the procedure from step 1.

### Note:

- Interrupt programmes (PTY or INFO) cannot be written to manual memory.

## Recalling a preset programme

1. Press the [SRC] button to select the DAB mode.
2. Touch [BAND].  
Each touch of [BAND] changes the display in the following order:  
**M1 → M2 → M3 → M1...**
3. Touch    on the right of the display to recall a preset programme.

## AF function

The AF function switches to a different frequency on the same network in order to maintain optimum reception.

- The factory default setting is “ON”.
- If the reception of the current broadcast station deteriorates, “SEARCH” appears in the display and the radio searches for the same programme on another frequency.
- For details on the “AF function”(cf. page 19) , refer to the section “RDS operation” of the respective owner’s manual.

● **To switch the AF function ON**

● **To switch the AF function OFF**

● **AF function between RDS and DAB**

When the same programme is broadcast by both RDS and DAB, and this function is ON, the main unit automatically switches to receive the broadcast with the better reception.

## TA (Traffic Announcement)

When a traffic announcement broadcast starts in the TA standby mode, the traffic announcement broadcast is received as top priority regardless of the function mode. Traffic programme (TP) automatic tuning is also possible.

- This function can only be used when “TP” is lit in the display. When “TP” is lit, this means that the DAB or RDS broadcast station being received has traffic announcement programmes.
- For details on “TA” (cf. page 20), refer to the section “RDS operation” of the respective owner’s manual.

● **To set the TA standby mode**

● **To cancel the TA standby mode**

● **To search for a TP station**

**Notes:**

- If a TP station is not received, the main unit stops the search operation.
- “TP” may be lit in the display when a TP broadcast is transmitted from an RDS station. In this case, press the [TA] button to perform TP seek tuning. Press the [TA] button again to return to the previous mode.

## INFO (Announcement)

In the INFO standby mode, when the selected announcement programme starts, the main unit automatically switches to the selected announcement programme.

● **To set the INFO standby mode**

If you press and hold the [TA] button for 1 second or longer, “INFO” lights in the display and the main unit is set to the INFO standby mode until the selected announcement is broadcast.

When the selected announcement broadcast starts, the announcement item appears in the display. If you press and hold the [TA] button for 1 second or longer while the selected announcement broadcast is being received, reception of the selected announcement broadcast is cancelled and the main unit enters the INFO standby mode.

● **To cancel the INFO standby mode**

To cancel the INFO standby mode, press and hold the [TA] button for 1 second or longer.

● **Information select**







This is a function for selecting INFORMATION ON or OFF in the Information interrupt mode.

You can set ON for up to 6 information items.

You can select any of the 6 items below:

INFORMATION item	
ENGLISH	Contents
Travel	Transport flash
Warning	Warning / Service
News	News flash
Weather	Area weather flash
Event	Event announcement
Special	Special event



1. Press the [MODE] button.
2. Touch [INFO SELECT] to enter the "INFO SELECT" mode.
3. Touch    on the left of the display to select an information item.  
You can select any of 6 items:  
**Travel → Warning → News → Weather → Event → Special → Travel...**
4. Touch    on the right of the display to select "ON" or "OFF".
5. Touch [RTN].

## PTY

This function enables you to listen to the selected programme type regardless of the function mode.

- One common PTY can be selected for DAB or RDS.
- Of DAB PTY and RDS PTY, the PTY which is received earlier takes priority over the other.
- PTY broadcasts are not yet available in all countries.
- In the INFO standby mode, INFO stations have priority over PTY stations.
- In the TA standby mode, TP stations have priority over PTY stations.
- For details on "PTY" (cf. page 21), refer to the section "RDS operation" of the respective owner's manual.

- To set the PTY standby mode
- To cancel the PTY standby mode
- To cancel a PTY interrupt broadcast
- To select PTY
- PTY seek
- PTY preset memory

## Emergency broadcast

When an emergency broadcast is received, all function mode operations are stopped, "ALARM" appears in the display, and the emergency broadcast can be heard.

- For details on "Emergency broadcast" (cf. page 22), refer to the section "RDS operation" of the respective owner's manual.
- To cancel an emergency broadcast

## Switching the PTY and INFO display language

You can select one of 4 languages (English, German, Swedish or French) for the PTY and INFO shown in the display.

- The factory default setting is "ENGLISH".
- For details on "Switching the PTY display language" (cf. page 23), refer to the section "RDS operation" of the respective owner's manual.

## Volume setting of TA, INFO, emergency broadcast (ALARM) and PTY

The volume for TA, INFO, ALARM and PTY interrupt broadcasts can be set during TA, INFO, ALARM and PTY interrupt broadcasts. Perform the following operation depending on the connected model.

- The factory default setting is "15".

During a TA, INFO, ALARM or PTY interrupt broadcasts, turn the [ROTARY] knob clockwise or counterclockwise to set the volume to a desired level (0 to 33).

- When the TA, INFO, ALARM or PTY interrupt broadcast ends, the volume returns to the level that was active before the interrupt broadcast.

# 8. IN CASE OF DIFFICULTY

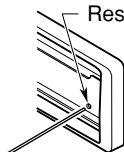
	Problem	Cause	Measure
General	Power does not turn on. (No sound is produced.)	Fuse is blown.	Replace with a fuse of the same amperage. If the fuse blows again, consult your store of purchase.
		Incorrect wiring.	Consult your store of purchase.
	No audio when operating the unit with amplifiers.	Amplifier turn-on lead is shorted to ground or excessive current is required.	Turn the unit off and check each wire for a possible short. If the amplifier turn-on lead shorts out, cover it with insulation such as tape.
	Nothing happens when buttons are pressed.	The microprocessor has malfunctioned due to noise, etc.	Turn off the power, then remove the DCP by referencing " <b>Removing the DCP</b> " (cf. page 10). Press the reset button for about 2 seconds with a thin rod. 
	Display is not accurate.	DCP or main unit connectors are dirty.	Wipe the dirt off with a soft cloth moistened with cleaning alcohol.
	No sound heard.	The speaker protection circuit is operating.	<ol style="list-style-type: none"> <li>1. Check the speaker connection.</li> <li>2. Turn down sound volume. Function can also be restored by turning the power off and on again.</li> <li>3. If the sound is muted again, consult your store of purchase.</li> </ol>
CD/MP3/WMA	No sound heard.	There is a disc other than a compact disc or foreign matter already in place.	With the SLOPING CONSOLE open, press and hold the [▲] button for 3 seconds or longer. The foreign matter is forcibly ejected.
		MP3/WMA files are absent in a disc.	Write MP3/WMA files onto the disc properly.
		Files are not recognized as an MP3/WMA file.	Use MP3/WMA files encoded properly.
		File system is not correct.	Use ISO9660 level 1, 2 or JOLIET or Romeo file system.
	Sound skips or is noisy.	Disc is dirty.	Clean the disc with a soft cloth.
		Disc is heavily scratched or warped.	Replace with a disc with no scratches.
	Sound is cut or skipped. Noise is generated or noise is mixed with sound.	MP3/WMA files are not encoded properly.	Use MP3/WMA files encoded properly.

	Problem	Cause	Measure
CD/MP3/WMA	Sound is bad directly after power is turned on.	Water droplets may form on the internal lens when the car is parked in a humid place.	Let dry for about 1 hour with the power on.
	Wrong filename	File system is not correct.	Use ISO9660 level 1, 2 or JOLIET or Romeo file system.
	Play list play is not performed.	File name or extension is not correct.	Use alphanumeric/ASCII characters for MP3/WMA file name. Use <b>“.M3U”</b> for the file extension of a play list.

## 9. ERROR DISPLAYS

If an error occurs, one of the following displays is displayed.  
Take the measures described below to eliminate the problem.

	Error Display	Cause	Measure
CD/MP3/WMA	<b>ERROR 2</b>	A DISC is caught inside the CD deck and is not ejected.	This is a failure of CD deck's mechanism and consult your store of purchase.
	<b>ERROR 3</b>	A DISC cannot be played due to scratches, etc.	Replace with a non-scratched, non-warped-disc.
	<b>ERROR 6</b>	A DISC is loaded upside-down inside the CD deck and does not play.	Eject the disc then reload it properly.
CD changer	<b>ERROR 2</b>	A DISC inside the CD changer is not loaded.	This is a failure of CD changer's mechanism and consult your store of purchase.
	<b>ERROR 3</b>	A DISC inside the CD changer cannot be played due to scratches, etc.	Replace with a non-scratched, non-warped disc.
	<b>ERROR 6</b>	A DISC inside the CD changer cannot be played because it is loaded upside-down.	Eject the disc then reload it properly.
DVD changer	<b>ERROR 2</b>	A DISC inside the DVD changer cannot be played.	This is a failure of DVD mechanism and consult your store of purchase.
	<b>ERROR 3</b>	A DISC cannot be played due to scratches, etc.	Retry or replace with a non-scratched, non-warped-disc.
	<b>ERROR 6</b>	A DISC inside the DVD changer cannot be played because it is loaded upside-down.	Eject the disc then reload it properly
	<b>ERROR P</b>	Parental level error	Set the correct Parental level.
	<b>ERROR R</b>	Region code error	Eject the disc and replace correct region code disc.
General	<b>AMP GUARD</b>	The speaker protection circuit is operating. During this operation, if any volume operation is performed, the display shows " <b>AMP GUARD</b> ". " <b>AMP GUARD</b> " sometimes functions when special test signals are used.	<ol style="list-style-type: none"> <li>1. Turn down sound volume. Function can also be restored by turning the power off and on again. (Speaker volume is reduced automatically when the speaker protection circuit operates).</li> <li>2. If the sound is muted again, consult our service department.</li> </ol>

If an error display other than the ones described above appears, press the reset button. If the problem persists, turn off the power and consult your store of purchase.

# 10. SPECIFICATIONS

## Radio section

Tuning System: PLL synthesizer tuner  
Receiving Frequencies:  
FM : 87.5 to 108 MHz (0.05 MHz steps)  
MW : 531 to 1602 kHz (9 kHz steps)  
LW : 153 to 279 kHz (3 kHz steps)

## CD Player

System:  
Compact disc digital audio system  
Usable Discs:  
Compact disc  
Frequency Response ( $\pm 1$  dB):  
5 Hz to 20 kHz  
Signal to Noise Ratio (1 kHz):  
100 dB  
Dynamic Range (1 kHz):  
96 dB  
Harmonic Distortion:  
0.01%

## Audio

Output Power:  
 $4 \times 31$  W (DIN 45324, +B=14.4 V)  
Continuous Average Power Output:  
 $18$  W  $\times 4$ , into  $4 \Omega$ , 20 Hz to 20 kHz, 1%THD  
Bass Control Action:  
+16, -12 dB  
Treble Control Action:  
 $\pm 12$  dB  
Line Output Level (CD 1 kHz):  
4 V/F 2ch + 4V/R 2ch  
4 V/SUB WOOFER 2ch

### Note:

- Specifications and design are subject to change without notice for further improvement.

## General

Power Supply Voltage:  
14.4 V DC (10.8 to 15.6 V allowable), negative ground  
Current Consumption:  
Less than 15 A, 3A  
Speaker Impedance:  
 $4 \Omega$  ( $4 \Omega$  to  $8 \Omega$  allowable)  
Weight / Main unit:  
1.7 kg  
Weight / Remote control unit:  
40 g (including battery)  
Dimensions / Main unit:  
 $178$  (W)  $\times 50$  (H)  $\times 160$  (D) mm  
Dimensions / Remote control unit:  
 $44$  (W)  $\times 113$  (H)  $\times 13$  (D) mm

# Clarion®

// High-Tech High-Touch //

» DICHIARAZIONE DI CONFORMITA' «  
(D.M. 28 agosto 1995, no548)

**Io, Fabbricante / Mandatario nell'UE**

**Clarion Europa GmbH  
Hessenring 19-21  
64546 Mörfelden-Walldorf**

**Dichiaro che il prodotto**

**Autoradio con CD  
DXZ858RMP**

**è conforme alle disposizioni contenute nel suddetto  
decreto relativamente alla prevenzione e l'eliminazione  
dei disturbi radioelettrici provocati dai ricevitori di  
radiodiffusione sonora e televisiva.**

Io, Fabbricante / Mandatario nell'UE

Data 1 Ottobre 2004

**Clarion Europa GmbH  
Hessenring 19-21  
64546 Mörfelden-Walldorf**

Firma 

PBL No 04IRJ002J

IDCFM1FA002

# Clarion Co., Ltd.

---

All Rights Reserved. Copyright © 2005: Clarion Co., Ltd.

2005/1 (Abe-Abe)

Printed in China / Imprimé en Chine / Gedruckt in China / Stampato in Cina  
Gedruckt in China / Impreso en China / Tryckt i Kina / Impresso na China

**PE-2744E**  
**280-8188-00**

## Free Manuals Download Website

<http://myh66.com>

<http://usermanuals.us>

<http://www.somanuals.com>

<http://www.4manuals.cc>

<http://www.manual-lib.com>

<http://www.404manual.com>

<http://www.luxmanual.com>

<http://aubethermostatmanual.com>

Golf course search by state

<http://golfingnear.com>

Email search by domain

<http://emailbydomain.com>

Auto manuals search

<http://auto.somanuals.com>

TV manuals search

<http://tv.somanuals.com>