

Clarion®

Owner's manual
Mode d'emploi
Manual de instrucciones
使用说明书

DXZ925

HIGHEND AM/FM RADIO CD PLAYER COMBINATION

COMBINE CD RADIO FM/AM HAUT DE GAMME

COMBINACIÓN DE RADIO DE AM/FM Y REPRODUCTOR DE DISCOS COMPACTOS DE ALTA POTENCIA

高档AM / FM收音机CD唱机组合装置

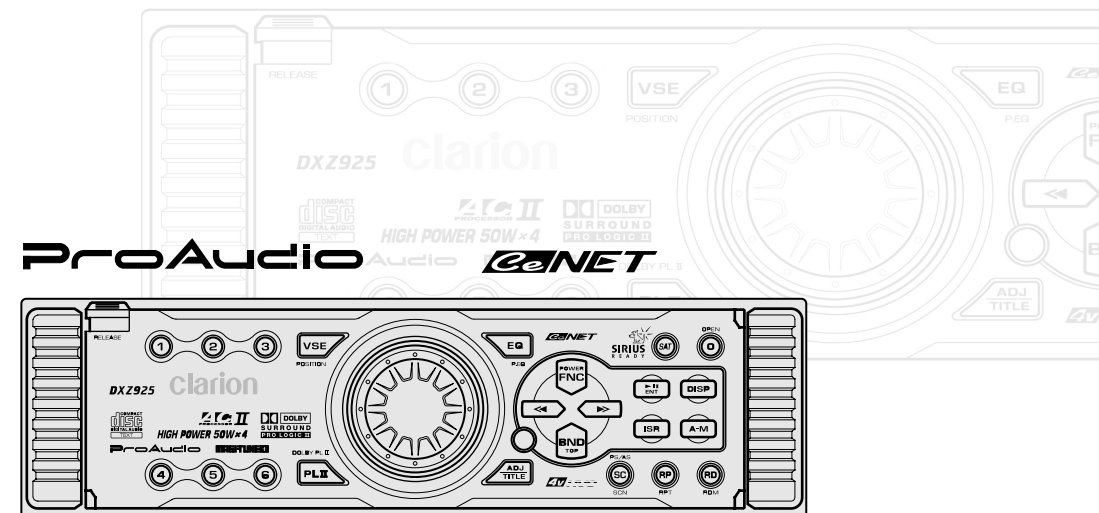

Clarion Co., Ltd.

All Rights Reserved. Copyright © 2001: Clarion Co., Ltd.
Printed in China / Imprimé en Chine / Impreso en China / 中国印刷

PE-2476B
280-7752-00



Thank you for purchasing this **Clarion** product.

- * Please read this owner's manual in its entirety before operating this equipment.
- * After reading this manual, be sure to keep it in a handy place (e.g., glove compartment).
- * Check the contents of the enclosed warranty card and keep it carefully with this manual.
- * This manual includes the operating procedures of the CD changer, MD changer, DVD changer, AUX, DAB, DSP DVD, PHONE MUTE and TV tuner connected via the CeNET cable. The CD changer, MD changer, DVD changer and TV tuner have their own manuals, but no explanations for operating them are described.

Contents

1. FEATURES	2
2. PRECAUTIONS	3
Dual Action	3
Handling Compact Discs	4
3. CONTROLS	5
4. NOMENCLATURE	6
Names of the Buttons and their Functions	6
Major button operations when external equipment is connected to this unit	7
Display Items	9
LCD Screen	9
5. REMOTE CONTROL	10
Names of Parts	10
Functions of Remote Control Unit Buttons	10
Loading Battery	10
Attaching the Remote Control Unit to the Steering Wheel	11
6. DCP	12
7. OPERATIONS	13
Basic Operations	13
AC-Processor II Operations	15
Radio Operations	18
CD Operations	20
Operations Common to Each Mode	21
8. OPERATIONS OF ACCESSORIES	24
CD/MD/DVD Changer Operations	24
TV Operations	26
Digital Radio/DAB Operations	27
DVD DECK Operations	31
9. IN CASE OF DIFFICULTY	32
10. ERROR DISPLAYS	33
11. SPECIFICATIONS	133

1. FEATURES

- Dual Action Detachable Aluminum Face
- Rotary Encoder volume Control
- Controller for Optional DAB, SIRIUS, TV Tuner CD, MD, DVD Changer, DVD Deck, B.B.DTS
- Capability to Read CD TEXT Data, CD-R, CD-RW
- CeNET with Balanced Audio Line Transmission and Dynamic Noise Cancelling
- **MAGTUNE3**® FM Reception System
- AC-Processor II including Dolby Pro Logic II for user like sound making
- 4V/4-Channel RCA LineLevel Output with Fader Control
- 2-Channel RCA AUX Input
- 200W(50W×4) Maximum Power Output

Dual Action

This unit uses Dual Action to make large-screen displays possible.

When you use the Dual Action, be sure to close it.

CAUTION

BE CAREFUL NOT TO GET YOUR FINGERS CAUGHT WHEN OPENING AND CLOSING THE DUAL ACTION.

1. For safety's sake, always close the DUAL ACTION before leaving this unit unused for a prolonged period or switching OFF the ignition key.

If you switch OFF the ignition key with the DUAL ACTION tilted, the DUAL ACTION does not close.



2. Before the DUAL ACTION closes, there may be a braking sound from the safety mechanism. This is normal.

3. If you move the DUAL ACTION by hand, this may create play. To correct this play, with the power on for the unit, press the [O] button to close the DUAL ACTION.

4. After a disc is ejected, the DUAL ACTION automatically returns to the tilted or closed state. If there is any obstruction when the DUAL ACTION tries to close, the safety mechanism is triggered and the DUAL ACTION returns to the open state. If this happens, remove the obstruction, then press the [O] button.

5. To avoid scratching the compact disc, keep the 12 or 8 cm CD level when inserting or removing them.

Handling Compact Discs

Use only compact discs bearing the  or  mark.

Do not play heart-shaped, octagonal, or other specially shaped compact discs.

Some CDs recorded in CD-R/CD-RW mode may not be usable.

Handling

• Compared to ordinary music CDs, CD-R and CD-RW discs are both easily affected by high temperature and humidity and some of CD-R and CD-RW discs may not be played. Therefore, do not leave them for a long time in the car.

• New discs may have some roughness around the edges. If such discs are used, the player may not work or the sound may skip. Use a ball-point pen or the like to remove any roughness from the edge of the disc.

• Never stick labels on the surface of the compact disc or mark the surface with a pencil or pen.

• Never play a compact disc with any cellophane tape or other glue on it or with peeling off marks. If you try to play such a compact disc, you may not be able to get it back out of the

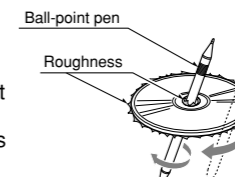

CD player or it may damage the CD player.

• Do not use compact discs that have large scratches, are misshapen, cracked, etc. Use of such discs may cause misoperation or damage.

• To remove a compact disc from its storage case, press down on the center of the case and lift the disc out, holding it carefully by the edges.

• Do not use commercially available CD protection sheets or discs equipped with stabilizers, etc. These may damage the disc or cause breakdown of the internal mechanism.

Storage

• Do not expose compact discs to direct sunlight or any heat source.

• Do not expose compact discs to excess humidity or dust.

• Do not expose compact discs to direct heat from heaters.

Cleaning

• To remove fingermarks and dust, use a soft cloth and wipe in a straight line from the center of the compact disc to the circumference.

• Do not use any solvents, such as commercially available cleaners, anti-static spray, or thinner to clean compact discs.

• After using special compact disc cleaner, let the compact disc dry off well before playing it.

2. PRECAUTIONS

1. When the inside of the car is very cold and the player is used soon after switching on the heater moisture may form on the disc or the optical parts of the player and proper playback may not be possible. If moisture forms on the disc, wipe it off with a soft cloth. If moisture forms on the optical parts of the player, do not use the player for about one hour. The condensation will disappear naturally allowing normal operation.
2. Driving on extremely bumpy roads which cause

severe vibration may cause the sound to skip.

3. When the auto antenna cord is connected to the car auto antenna cord, when the unit is switched to the radio mode (or the TV mode), the antenna is extended automatically. If the car is in a narrow space, the antenna may strike something, so be careful.

4. This unit uses a precision mechanism. Even in the event that trouble arises, never open the case, disassemble the unit, or lubricate the rotating parts.

CAUTION

USE OF CONTROLS, ADJUSTMENTS, OR PERFORMANCE OF PROCEDURES OTHER THAN THOSE SPECIFIED HEREIN, MAY RESULT IN HAZARDOUS RADIATION EXPOSURE.

THE COMPACT DISC PLAYER and MINI DISC PLAYER SHOULD NOT BE ADJUSTED OR REPAIRED BY ANYONE EXCEPT PROPERLY QUALIFIED SERVICE PERSONNEL.

CHANGES OR MODIFICATIONS NOT EXPRESSLY APPROVED BY THE MANUFACTURER FOR COMPLIANCE COULD VOID THE USER'S AUTHORITY TO OPERATE THE EQUIPMENT.

INFORMATION FOR USERS:

CHANGES OR MODIFICATIONS TO THIS PRODUCT NOT APPROVED BY THE MANUFACTURER WILL VOID THE WARRANTY AND WILL VIOLATE FCC APPROVAL.

This equipment has been tested and found to comply with the limits for a Class B digital device, pursuant to Part 15 of the FCC Rules.

These limits are designed to provide reasonable protection against harmful interference in a residential installation.

This equipment generates, uses, and can radiate radio frequency energy and, if not installed and used in accordance with the instructions, may cause harmful interference to radio communications. However, there is no guarantee that interference will not occur in a particular installation.

If this equipment does cause harmful interference to radio or television reception, which can be determined by turning the equipment off and on, the user is encouraged to consult the dealer or an experienced radio/TV technician for help.

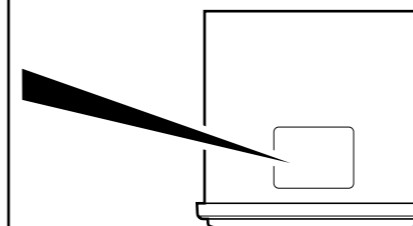

Bottom View of Source Unit

What is Sirius Satellite Radio?



Sirius is radio the way it was meant to be: Up to 100 new channels of digital quality programming delivered to listeners coast to coast via satellite. That means 50 channels of completely commercial-free music. Plus up to 50 more channels of news, sports, and entertainment from names like CNBC, Discovery, SCI-FI Channel, A&E, House of Blues, E!, NPR, Speedvision and ESPN.

Sirius is live, dynamic entertainment, completely focused on listeners. Every minute of every day of every week will be different. All 50 commercial-free music channels are created in-house and hosted by DJs who know and love the music. Do you like Reggae? How about Classic Rock or New Rock? Sirius has an array of choices spanning a vast range of musical tastes including the hits of the 50's, 60's, 70's, & 80's as well as Jazz, Country, Blues, Pop, Rap, R&B, Bluegrass, Alternative, Classical, Heavy Metal, Dance and many others...

From its state-of-the-art, digital broadcasting facility in Rockefeller Center, New York City, Sirius will deliver the broadest, deepest mix of radio entertainment from coast to coast.

Sirius will bring you music and entertainment programming that is simply not available on traditional radio in any market across the country. It's radio like you've never heard before.

So Get Sirius and Listen Up! For more information, visit siriusradio.com.

When the Sirius Satellite Radio is connected

* For details, refer to the Owner's Manual provided with the Sirius Satellite Radio.

[FNC] button

- Press the button to switches the operation mode among the SIRIUS mode, etc.

[SC] button

- Press the button to perform category scan while in the SIRIUS mode.
- Press and hold the button to perform preset scan while in the SIRIUS mode.

[DIRECT] button

- Stores a station into memory or recall it directly while in the SIRIUS mode.

[◀], [▶] buttons

- Press the button to selects a station.

[SAT] button

- Press the button to switches the SIRIUS mode.

3. CONTROLS/LES COMMANDES/CONTROLES/控制器

Source unit / Appareil pilote / Unidad fuente / 主机

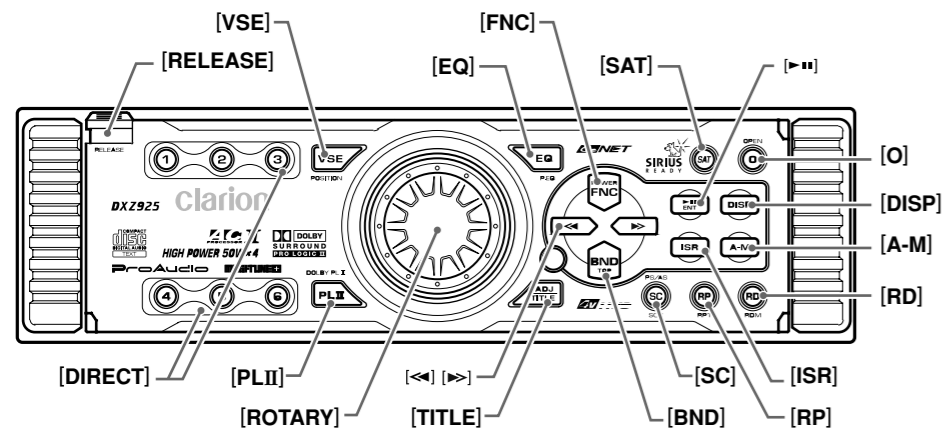

With the Dual Action opened / Lorsque la Double action est ouverte
Con el panel frontal de acción doble abierto / 双动作机构开启状态

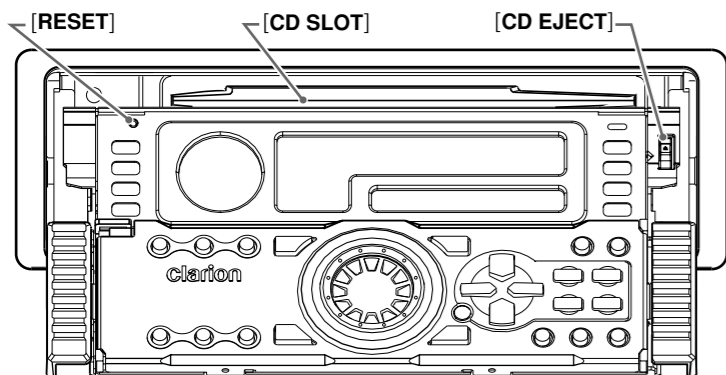

Note: Be sure to unfold this page and refer to the front diagrams as you read each chapter.
Remarque: Veuillez déplier cette page et vous référer aux schémas quand vous lisez chaque chapitre.
Nota: Cuando lea los capítulos, despliegue esta página y consulte los diagramas.
注意: 阅读各章时请务必展开本页并参照前视图。

4. NOMENCLATURE

Note:

• Be sure to read this chapter referring to the front diagrams of chapter "3. CONTROLS" on page 5 (unfold).

Names of the Buttons and their Functions

[RELEASE] button

- Deeply press the button to remove the DCP.

[VSE] button

- Press to enter VSE mode or the Position mode.
- When the button is pressed and hold for 1 second or longer, the mode is turned on or off.

[EQ] button

- Press to enter the EQ mode.
- When the button is pressed and hold for 1 second or longer, the mode is turned on or off.

[FNC] button

- Press the button to turn on the power. Press and hold the button for 1 second or longer to turn off the power.
- Switches the operation mode among the radio mode, etc.

[SAT] button

- This button is available only when the unit is connected with Satellite Digital Radio Tuner (sold separately DSH920S).

[▶||] button

- Plays or pauses a CD while in the CD mode.
- Used as "Enter button" while the unit is in the ADJ mode.

[O] button

- Use the button to open the dual action.

[DISP] button

- Switches the display indication (Main display, clock display).

[A-M] button

- Use the button to switch to the audio mode (balance/fader/sub.w/center SP/NF. adjustment)

[RD] button

- Performs random play while in the CD mode.

[ISR] button

- Recalls ISR radio station in memory.
- Press and hold for 2 seconds or longer: Stores current station into ISR memory (radio mode only).

[RP] button

- Plays repeatedly while in the CD mode.

[SC] button

- Performs preset scan while in the radio mode. When the button is pressed and held, auto store is performed.
- Performs scan play for 10 seconds for each track while in the CD mode.

[BND] button

- Switches the band, or seek tuning or manual tuning while in the radio mode.
- Plays a first track while in the CD mode.

[TITLE] button

- Use the button to input a title in the CD mode and radio mode.
- Press and hold the button for 1 second or longer to enter the adjust mode.

[◀], [▶] buttons

- Selects a station while in the radio mode or selects a track when listening to a CD. These buttons are used to make various settings.

[ROTARY] knob

- Adjust the volume by turning the knob clockwise or counterclockwise.
- Use the knob to perform various settings.

[PLII] button

- Press to select the Dolby Pro Logic II mode.

[DIRECT] button

- Stores a station into memory or recall it directly while in the radio mode.

[CD SLOT]

- CD insertion slot.

[CD EJECT] button

- Press to eject a CD loaded in the unit.
- Press to open the CD slot and insert a CD.

[RESET] button

- Press to reset the system.

Major button operations when external equipment is connected to this unit

● When the CD/MD/DVD changer is connected

- * For details, see the section "CD/MD/DVD changer operations". For the DVD changer, refer to the Owner's Manual provided with the DVD changer.

[SC] button

- Performs scan play for 10 seconds for each track. Disc scan play is performed when the button is pressed and held.

[RP] button

- Performs repeat play. When this button is pressed and held, disc repeat play is performed.

[RD] button

- Performs random play. Also performs disc random play when the button is pressed and held.

[DIRECT] button

- Designates the disc to be played.

[DISP] button

- Switches the clock or selects the title mode.
- When the button is pressed and held, the user titles or disc titles are switched.

[TITLE] button

- Use the button to input a title in the CD changer mode.
- Use the button to scroll the title during CD-text play or MD changer play in the CD changer mode.

[▶||] button

- Plays or pauses a CD, MD or DVD.

[◀], [▶] buttons

- Selects a track when listening to a disc.

[BND] button

- Plays a first track.
- Used as "disc up button" while the unit is in the DVD changer mode.

● When the TV/DAB is connected

- * For details, see the section "TV operations" or "DAB operations".

[SC] button

- Used to perform preset or category scan while the unit is in the radio mode. When the button is pressed and held, auto store is performed. (This function is available only in the TV tuner mode.)

[RP] button

- Press the button to turn on or off the AF (Alternative Frequency) function in the DAB mode. (This function is only DAB tuner.)

[RD] button

- Use the button to set the PTY (Programme Type) standby mode or PTY items in the DAB mode.
- Switches the TV picture mode or VTR (external) picture mode.

[DIRECT] button

- Stores a station into memory or recall it directly.

[◀], [▶] buttons

- Selects a station.

[BND] button

- Switches the band.
- When the button is pressed and held, switches seek tuning or manual mode.

● When the DTS/DOLBY DIGITAL is connected

[VSE] button

- Press the button to turn on the DSF.
- After DSF is selected, press and hold the [VSE] button for 1 second or longer to turn to off DSF effect.

[PLII] button

- Press the button to turn on the PLII, and each time to press PLII mode changes following order:
Music mode → Matrix mode → Movie mode → Virtual mode → mode off

Display Items

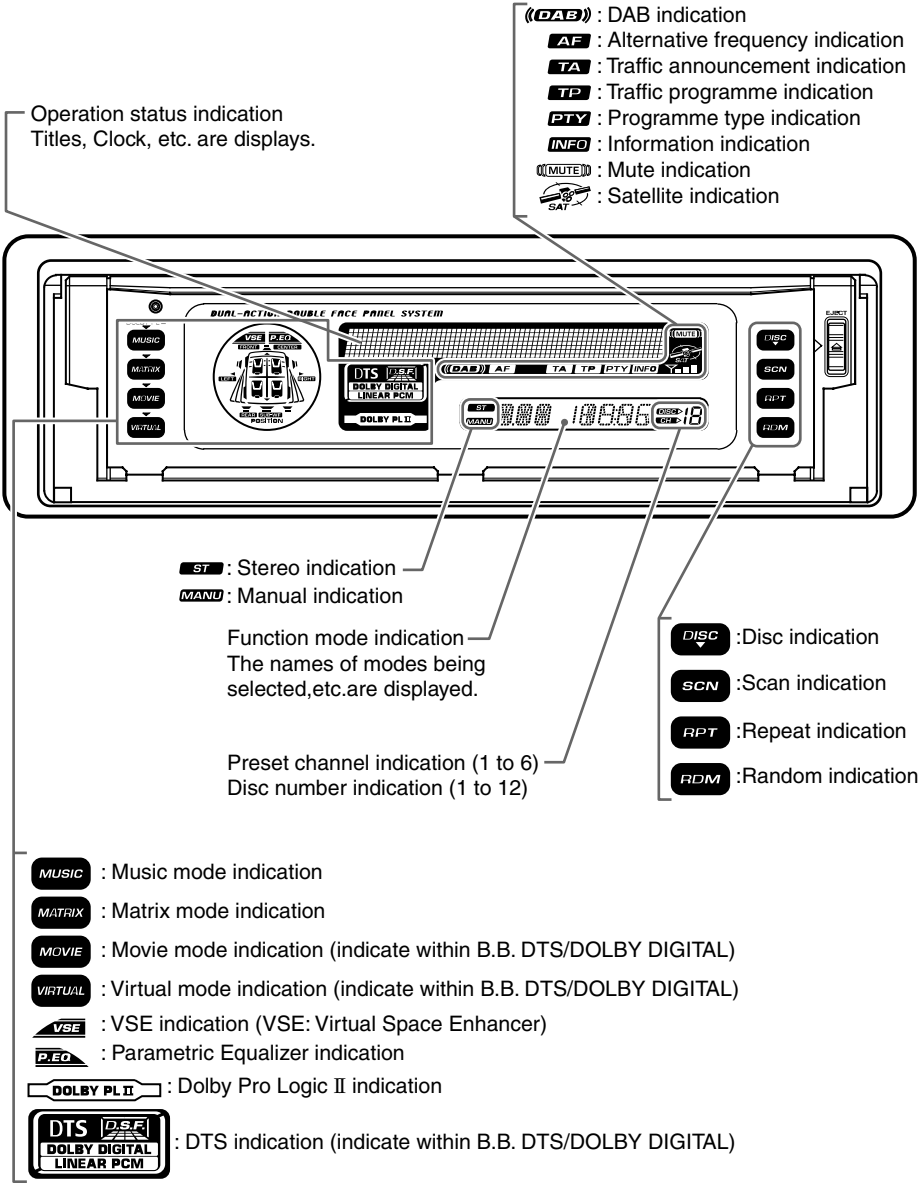

LCD Screen

In extreme cold, the screen movement may slow down and the screen may darken, but this is normal. The screen will recover when it returns to normal temperature.

5. REMOTE CONTROL

Names of Parts

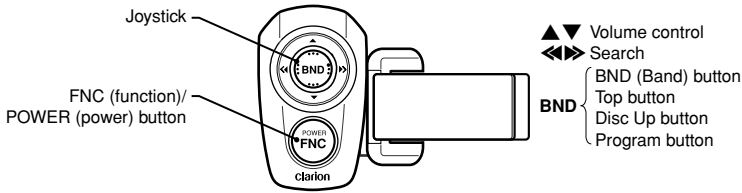

Functions of Remote Control Unit Buttons

Mode Button	Radio (DAB) (SIRIUS)	CD	CD/MD changer DVD changer	TV
[FUNC]	Switches among radio, DAB, SIRIUS, CD, DVD deck, CD/MD changer, DVD changer, TV, and AUX.			
[BAND]	Switches reception band.	Plays the first track. Top play.	Moves the next disc in increasing order.	Switches reception band.
[▲], [▼]	Increases and decreases volume (in all modes).			
[<<], [>>]	Moves preset channels up and down.	Moves tracks up and down. When pressed and held for 1 second: Fast-forward/fast-backward.		Moves preset channels up and down.

* Some of the corresponding buttons on the main unit and remote control unit have different functions.

Loading Battery

1. Open the battery cover.

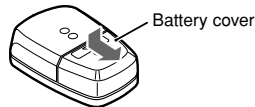

2. Insert the supplied lithium battery (CR2032) with the plus ⊕ symbol facing up and close the battery cover.

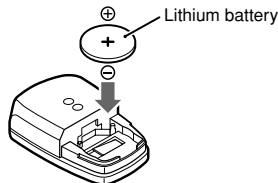

Loading Battery

Notes:

Using batteries improperly can cause them to explode. Take note of the following points:

- Do not short-circuit, disassemble or heat batteries.
- Do not dispose of batteries into fire or flames.
- Dispose of spent batteries properly.

Attaching the Remote Control Unit to the Steering Wheel

1. Attach the holder to the steering wheel.

The diagrams below show how to install the remote control unit on the steering wheel of a car with the steering wheel on the Left. Install the remote control unit on the Left in a car with the steering wheel on the right side.

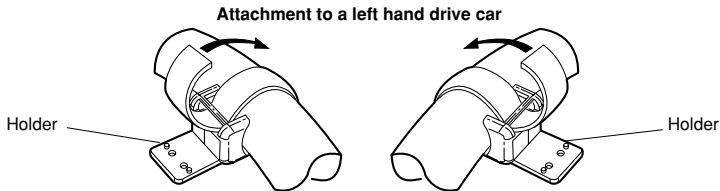

2. Installing the steering wheel remote control unit

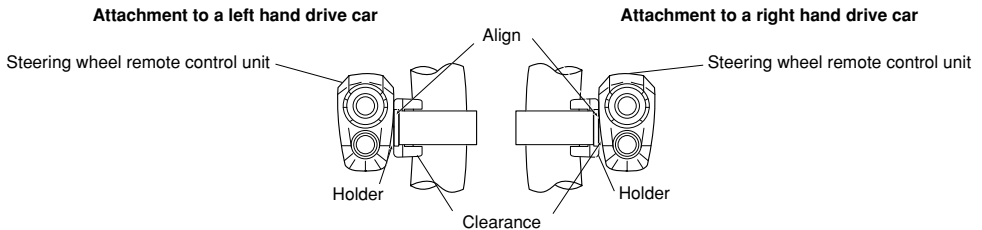
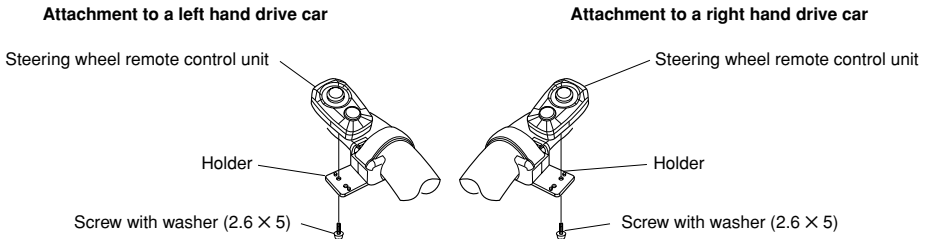

Note:

The location to be chosen for the remote control unit depends on the configuration of the steering wheel. Make sure that the installation of the remote control unit does not prevent normal driving and that the remote control signal reaches the remote control sensor.

6. DCP

The control panel can be detached to prevent theft. When detaching the control panel, store it in the DCP (DETACHABLE CONTROL PANEL) case to prevent scratches.

We recommend taking the DCP with you when leaving the car.

Removing the DCP

1. With the DUAL ACTION closed, turn off the power.
2. Press the [RELEASE] button deeply and take and pull the DCP to detach the DCP.

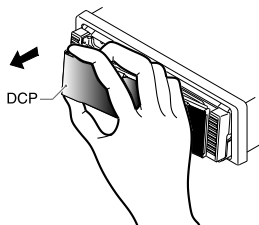

Attaching the DCP

1. Insert the DCP so that the (A) section on the right side of the DCP catches on the hook (B) on the unit.

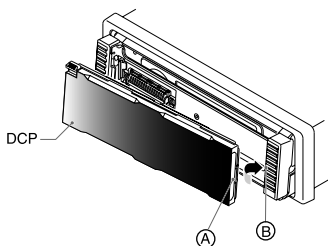

2. Press the left side (C) of the DCP carefully to fit it in place.

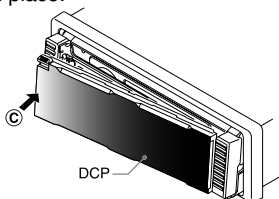

⚠ CAUTION

- Always close the DUAL ACTION before removing the DCP.
- If you remove the DCP with the DUAL ACTION open, the sloping console closes immediately. Be careful not to get your fingers caught.
- The DCP can easily be damaged by shocks. After removing it, be careful not to drop it or subject it to strong shocks.
- If the [RELEASE] button is pressed and the DCP is not locked into place, it may fall out from vibration of the car. This can break the DCP, so after removing it, either install it on the unit or put it in its DCP case.
- The connector connecting the unit and the DCP is an extremely important part. Be careful not to damage it by pressing on it with fingernails, screwdrivers, etc.
- If you apply to the control panel more force than that required with the control panel left open, the control panel will go down one step. This is due to safety mechanism engaged and is not a malfunction. In this case, press the [O] button two times to return the control panel to the original operating position. Using the control panel being lowered results in a damage to the panel.
- Do not use the control panel being left open as a tray to put an object on.
- Moving the control panel manually will cause a malfunction such as getting out of order of the sloping mechanism, breakdown of the gears, etc. Do not draw the control panel forcibly. When the control panel is moved manually, press the [O] button several times to see if the control panel returns to the normal position and functions properly.
- Do not remove the DCP while you are driving a car.
- Do not use the DCP being rickety.
- Do not carry the DCP in a trouser pocket or the like directly. (The DCP may be damaged under load conditions.)
- The DCP may jump out of the DCP case housing the DCP when the case is opened energetically.

Note:

- If the DCP is dirty, wipe off the dirt with a soft, dry cloth only.

7. OPERATIONS

Basic Operations

Note: Be sure to read this chapter referring to the front diagrams of chapter "3. CONTROLS" on page 5 (unfold).

⚠ CAUTION

Be sure to lower the volume before switching off the unit power or the ignition key. The unit remembers its last volume setting. If you switch the power off with the volume up, when you switch the power back on, the sudden loud volume may hurt your hearing and damage the unit.

Turning on/off the power

Note:

• Be careful about using this unit for a long time without running the engine. If you drain the car's battery too far, you may not be able to start the engine and this can reduce the service life of the battery.

1. Press the [FNC] button.
2. The illumination and display on the unit light up. The unit automatically remembers its last operation mode and will automatically switch to display that mode.
3. Press and hold the [FNC] button for 1 second or longer to turn off the power for the unit.

Note:

• System check

The first time this unit is turned on after the wire connections are completed, it must be checked what equipment is connected. When the power is turned on, "SYSTEM CHCK" and "Push Power" appear in the display alternately, so press the [FNC] button. The system check starts within the unit. When the system check is complete, the power is turned off, so press the [FNC] button again.

Selecting a mode

1. Press the [FNC] button to change the operation mode.
2. Each time you press the [FNC] button, the operation mode changes in the following order:
Radio mode → DAB mode → SIRIUS mode → CD mode → DVD DECK mode → CD changer mode → MD changer mode → DVD changer mode → TV mode → AUX mode → Radio mode...

* External equipment not connected with CeNET is not displayed.

Adjusting the volume

Turning the [ROTARY] knob clockwise increases the volume; turning it counterclockwise decreases the volume.

* The volume level is from 0 (minimum) to 33 (maximum).

Switching the display

Press the [DISP] button to select the desired display.

Each time you press the [DISP] button, the display switches.

* Once selected, the preferred display becomes the display default. When a function adjustment such as volume is made, the screen will momentarily switch to that function's display, then revert back to the preferred display several seconds after the adjustment.

* When you have entered a title in a CD/MD, it appears in the main display. If you have not entered a title, "[D] NO-TITLE" or "[T] NO-TITLE" appears in the title display instead. For information on how to enter a title, refer to the subsection "Entering titles" in section "Operations Common to Each Mode".

Setting the clock

1. Press and hold the [TITLE] button for 1 second or longer to enter ADJ mode.
2. Press the [◀] or [▶] button to select the "CLOCK".
3. Press the [▶||] button.
4. Press the [◀◀] or [▶▶] button to select the hour or the minute.
5. Turn the [ROTARY] knob clockwise or counterclockwise to adjust the correct time.
* The clock displayed in 12-hour format.
6. Press the [▶||] button to store the time into memory.
7. Press the [TITLE] button to return to the previous mode.

Note:

• You cannot set the clock when it is displayed with only the ignition on. If you drain or remove the car's battery or take out this unit, the clock is reset. While setting the clock, if another button or operation is selected, the clock set mode is canceled.

Basic Operations

Adjusting the balance

1. Press the [A-M] button and select "BALANCE".
2. Turning the [ROTARY] knob clockwise emphasizes the sound from the right speaker; turning it counterclockwise emphasizes the sound from the left speaker.
 - * The factory default setting is "0". (Adjustment range: L13 to R13)
3. When the adjustment is complete, press the [A-M] button several times until the function mode is reached.

Adjusting the fader

1. Press the [A-M] button and select "FADER".
2. Turning the [ROTARY] knob clockwise emphasizes the sound from the front speakers; turning it counterclockwise emphasizes the sound from the rear speakers.
 - * The factory default setting is "0". (Adjustment range: F12 to R12)
3. When the adjustment is complete, press the [A-M] button several times until the function mode is reached.

Operation BASS/TREB

1. Press the "BASS/TREB" mode. Each time the [EQ] button is pressed, the adjusting item "BASS" or "TREB" is changed cyclically.
2. Turn the [ROTARY] knob clockwise or counterclockwise to adjust "BAS/TREB".
3. Press the [EQ] button to return to the previous mode.
 - * The Adjustment range is from -6dB to +6dB for bass and treb.
 - * This parameter is reflected STD PRO mode

Speaker Setting

You can set up your favorite sound environment using "Dolby Surround Pro Logic II" or "AC-Processor II" so that you can enjoy a dynamic sound of 5.1 ch surround or 4ch + 2ch speaker.

●Dolby Pro Logic II 5.1ch surround

Center SP +Front L.R. +Surround L.R. +Sub Woofer.

To make the most of the sound field reproduction of Dolby Pro Logic II, a speaker system of 5.1 channel is recommendable. It has been also designed so that a sound filed effect almost as good as that of 5.1 channel reproduction can be obtained even by a constitution of 4 channel + 1

channel (subwoofer).

If you using Dolby Pro Logic source and your speaker is only four Front L.R. + Surround L.R., speaker setting will be better to CTR+SW and CTR OFF, so Center channel divided to Front L.R. automatically.

Note

- When SW-L + SW-R are chosen, audio output from SW-L is not available in the PL II mode.

●AC-Processor II

Front L.R. + Rear L.R.+ Sub Woofer L.R. (4ch + 2ch)

To make the most of the sound field reproduction of AC-Processor II, a speaker system of 4 channel + 2 channel is recommendable.

1. Press and hold the [TITLE] button for 1 second or longer and enter "ADJ" mode.
2. Press the [◀] or [▶] button to select the "SP-SETTING".
3. Turn the [ROTARY] knob clockwise or counterclockwise to select "SW L+SW R" or "CTR +SW" mode.

Note:

- When CTR + SW are chosen, audio output from CTR is not available except in the PL II mode.

Center Speaker and Sub Woofer On / Off

Select PLII Mode on and SP setting to "CTR+SW" mode

1. Press and hold the [TITLE] button for 1 second or longer.
2. Press the [◀] or [▶] button to select the "SP SEL".
3. Press the [▶III] button to adjust the "CTR-SP" "SUB W".
4. Turn the [ROTARY] knob clockwise or counterclockwise to select "ON" or "OFF".
 - * This function is useful for Speaker Setting Problems.

Filter Adjustment

1. Select Dolby Pro Logic II or AC-ProII mode and press and hold the [TITLE] button for 1 second or longer.
2. Press the [◀] or [▶] button to select the "FILTER".
3. Press the [▶III] button to adjust the "SUB-W LPF" or "HPF".
4. Turn the [ROTARY] knob clockwise or counterclockwise to adjust filter frequency.

Basic Operations

- * Sub Woofer Low Pass Filter Adjustment Range is 50, 80, 120Hz (18dB/oct), OFF.
- * When PLII mode Sub Woofer Low pass Filter Adjustment Range is 50, 80, 120Hz (12dB/oct.), OFF.
- * High Pass Filter adjustment Range is 50, 80, 120Hz(12dB/oct), thrgh.

Note:

- High pass filter adjustment is available for Front 2ch and Rear 2ch only AC-ProII PRO Mode.

AC-Processor II Operations

Dolby Pro Logic II

Dolby Pro Logic II is a matrix decoding technology in which the updated digital matrix technology is applied and Dolby Pro Logic is further improved. It realizes excellent 5.1 channel reproduction of Dolby surround source as well as stereo sound sources such as CDs, thereby causing a surround channel to be full-ranged (20 Hz to 20 kHz) and become stereo. Therefore, you can enjoy any stereo sources with dynamic sound of 5.1 channel. According to a source to be reproduced, Music Mode or Matrix Mode can be selected.

* Produced on the basis of the license of Dolby Laboratory Inc.

Dolby, Pro Logic, and Double D's are trademarks of Dolby Laboratory Inc. Unpublished Documents. Copyright 1992 – 1997 Dolby Laboratory Inc. All rights reserved.

● Music Mode

This mode is suitable for stereo sources like CDs. By optimizing frequency characteristics of the surround channel, a broader and deeper sound is assured. In addition, since broadness of the sound field varies with recording conditions of music sources, there is Adjusting Mode which makes a finer tuning available. (cf. page 16)

● Matrix Mode

This mode is suitable for AM/FM radio.

Note:

- Due to the characteristics of Dolby Pro Logic II, the sound is heard at a lower volume from the speakers when you change the AC-PII STD, AC-PII PRO, or P.EQ mode to the Dolby Pro Logic II mode.

Selection and switching of the Dolby Pro Logic II effect

While the "Dolby PLII" indication is lit in the display, the "Dolby PLII" effect is set to "On".

1. Setting the speaker 5.1ch (For detail, see the section Basic Operation - Speaker setting).
2. Press the [PLII] button so that PLII mode is turned on. Each time the button is pressed, the mode changes as follows: "MUSIC MODE" → "MATRIX MODE" → "PLII OFF MODE" → "MUSIC MODE"
3. Select the "PLII OFF MODE" to turn off the Dolby Pro Logic effect. Also press the [VSE] button or [EQ] button to turn off the Dolby Pro II.

AC-Processor II Operations

Adjusting Dolby Pro Logic II Operation

1. Select Dolby Pro Logic II mode and press and hold the [TITLE] button for 1 second or longer to enter "ADJ" mode.
2. Press the [◀] or [▶] button to select the "PLII DELAY".
3. Press the [▶||] button to adjust the "PLII DELAY".
4. Turn the [ROTARY] knob clockwise or counterclockwise to make the adjustment.
 - * The adjustment range of surround speaker delay is from 0m sec. to 15m sec.
 - * The adjustment made in "PLII DELAY" is reflected in the each mode.

Adjusting Music Mode

Use the MUSIC MODE to make more detailed adjustments.

1. Select "Music Mode" and press and hold the [TITLE] button for 1 second or longer.
2. Press the [◀] or [▶] button to select the "PLII CONT".
3. Press the [▶||] button to adjust the "PLII CONT" detail items.
4. Press the [◀] or [▶] button to select the items.
5. Turn the [ROTARY] knob clockwise or counterclockwise to make the adjustment.
 - * The detailed adjustments depend on each of the adjustment items. There are 3 items: "PANORAMA", "DIMENSION", and "CTR WIDTH".

PANORAMA (Y or N):

Selecting PANORAMA mode will extend the front sound field image to the rear. If surround effect does not seem to be presented sufficiently, select the setting position "Y".

DIMENSION (0 to 6):

Selecting DIMENSION mode will shift the sound field image to the front or the rear. If the balance of the sound field image is too much pulled towards the front or rear, the balance front/rear can be corrected. The adjusting value 3 is the center position. The range of 3 to 0 shifts the balance front/rear to the front. The range of 3 to 6 shifts the balance front/rear to the rear.

CTR WIDTH (0 to 7):

Selecting CTR WIDTH mode will adjust the localization of the center channel between the center speaker and the front speaker L/R.

Distributing the center channel sound to the right and left will increase the integrated sound field image, providing you with an natural spatial feeling of sound.

Setting to the value 0 will produce the center sound with the center speaker.

Setting to the value 7 will distribute the center sound to the front speaker L/R as the existing stereo sound does.

AC-Processor II Operation

There are 2 modes "STD" (standard) and "PRO" (professional) in the AC-ProII.

1. Setting the speaker to 4ch+2ch (For details, refer to the subsection "Speaker Setting" in the section "Basic Operations").
2. Turn off the PLII mode.
3. Press and hold the [TITLE] button for 1 second or longer and enter "ADJ" mode.
4. Press the [◀] or [▶] button to select the "AC-P II SEL".
5. Press the [▶||] button to select AC-ProII mode from "STD" or "PRO".
6. Turn the [ROTARY] knob clockwise or counterclockwise to select "STD" or "PRO".
7. Press the [TITLE] button to the previous mode.

Operation AC-P II STD

1. Press the [VSE] button to enter VSE mode.
2. Press the [BND] button to select "VSE BASIC".
3. Press the [DIRECT] button to select VSE menu as below.
 1. **Flat:** original sound, flat equalizing
 2. **Bass boost:** deep bass sound emphasized
 3. **High boost:** middle and high sound area emphasized
 4. **Impact:** low and high sound area emphasized
 5. **Acoustical:** middle sound area emphasized (human voice)
 6. **Smooth:** quiet and graceful feeling
4. Press the [VSE] button to return to the previous mode.
5. Press and hold the [VSE] button for 1 second or longer so that the VSE effect is turned on or off.

AC-Processor II Operations

Adjusting AC-P11 STD

AC-P11 STD makes natural stereo feeling for every seat by virtual space enhancer.

VSE, which is room simulation, can correct the sound pressure inside the car so that the uniform sound effect is obtained at any seats.

1. Select "VSE" menu which you want to edit on the basis of.
2. Press and hold the [TITLE] button for 1 second or longer.
3. Press the [◀] or [▶] button to select item to be adjusted.

There are "DIFFUSE" "CAR WIDTH" and "CAR LENG" available for the items to be adjusted.

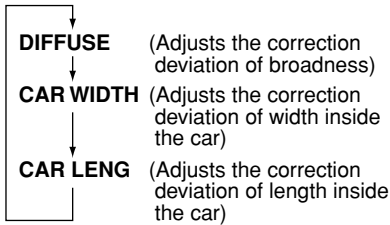

4. Turn the [ROTARY] knob clockwise or counterclockwise to make the adjustment.

The adjustment range is from 1 to 10 for each item.

5. Press and hold the [DIRECT] buttons for 2 seconds or longer to store the edited contents.

* You can give a title to user memory. For the inputting method of titles, refer to the subsection "Entering titles" in section "Operations common to each mode".

Operation AC-P11 PRO

Arrival time of sound from the speaker can be selected from among five types according to the position of the seat. In addition, Time Alignment Function enables a pinpoint speaker setting to obtain a uniform sound effect from speakers to the listener.

1. Press the [VSE] button to enter POSITION mode.
2. Press the Band button to select "POS BASIC".
3. Press the [DIRECT] button to select VSE menu as below.
 - 1.FRONT-L 2.FRONT-R 3.FRONT 4.REAR
 - 5.FULL SEAT
4. Press the [VSE] button to return to the previous mode.

5. Press and hold the [VSE] button for 1 second or longer so that the POSITION effect is turned on or off.

Adjusting AC-P11 PRO

1. Select "VSE" menu which you want to edit on the basis of.
2. Press and hold the [TITLE] button for 1 second or longer.
3. Press the [◀] or [▶] button to select item to be adjusted.
 - * There are "TIME ALIGN" and "SP GAIN" available for the items to be adjusted.
4. Press the [▶▶] button.
5. Press the [◀] or [▶] button to select the channel to be adjusted. Available channels are: "FRONT-L", "FRONT-R", "REAR-L", "REAR-R", "SW-L" and "SW-R".
6. Turn the [ROTARY] knob clockwise or counterclockwise to make the adjustment.

The adjustment of "TIME ALIGN" range is from 0 cm to 500cm.

The adjustment of "SP-GAIN" range is from 0db to -20dB for each channel.

7. Press and hold the [DIRECT] buttons for 2 seconds or longer to store the edited contents.

* You can give a title to user memory. For the inputting method of titles, refer to the subsection "Entering titles" in section "Operations common to each mode".

EQ Operation

There are 2 mode for sound EQ "P.EQ" mode and "BASS/TREB" mode selecting EQUALIZING mode.

1. Press and hold the [TITLE] button for 1 second or longer and enter "ADJ" mode.
2. Press the [◀] or [▶] button to select the "AC-P11 SEL".
3. Press the [▶▶] button to enter AC-PRO2 select mode "STD" or "PRO".
4. Then press the [◀] or [▶] button to select the "EQ SEL".
5. Turn the [ROTARY] knob clockwise or counterclockwise to select "P.EQ" or "BAS/TREB" mode.
6. Press the [TITLE] button to return to the previous mode.

* (Factory default setting is P.EQ)

AC-Processor II Operations

Operation P.EQ

A full range of frequency level can be minutely corrected with a smooth curve by frequency correction in accordance with car models. Six kinds of P.EQ basic menus have been pre-stored in this unit according to the car models and the mounting positions of speakers. Thus, set it in accordance with the car type.

1. Press the [EQ] button to enter "P.EQ" mode.
2. Press the Band button to select "P.EQ BASIC".
3. Press the [DIRECT] button to select P.EQ menu as below.
1.SEDAN-1 2.SEDAN-2 3.WAGON-1
4.WAGON-2 5.MINI VAN-1 6.MINI VAN-2
4. Press the [EQ] button to return to the previous mode.
5. Press and hold the [EQ] button for 1 second or longer so that the P.EQ effect is turned on or off.

Adjusting P.EQ

1. Select "P.EQ" menu which you want to edit on the basis of.
2. Press and hold the [TITLE] button for 1 second or longer.
3. Press the [◀] or [▶] button to select item to be adjusted.

There are "FRONT/REAR", "BAND", "FREQ" "GAIN" and "Q" available for the items adjusted.

5. Press and hold the [DIRECT] buttons for 2 seconds or longer to store the edited contents.
 - * You can give a title to user memory. For the inputting method of titles, refer to the subsection "Entering titles" in section "Operations common to each mode".
 - * The parameter created in this section is also effective when the unit is in both the "STD" and "PRO" mode.

Radio Operations

FM reception

For enhanced FM performance the **MAGITUNE**® tuner includes signal actuated stereo control, Enhanced Multi AGC, Impulse noise reduction circuits and Multipath noise reduction circuits.

Changing the reception area

This unit is initially set to USA frequency intervals of 10kHz for AM and 200kHz for FM. When using it outside the USA, the frequency reception range can be switched to the intervals below.

●Setting the reception area

1. Press the [BND] button and select the desired radio band (FM or AM).
2. While pressing the [DISP] button, each time you press and hold the number "6" of the [DIRECT] buttons for 2 seconds or longer, the reception area switches from inside the USA to outside the USA or from outside the USA to inside the USA.
 - * Any station preset memories are lost when the reception area is changed.

Listening to the radio

1. Press the [FNC] button and select the radio mode. The frequency or PS appears in the display.
 - * PS: Programme service name
2. Press the [BND] button and select the radio band. Each time the button is pressed, the radio reception band changes in the following order:
 FM1 → FM2 → FM3 → AM → FM1...
3. Press the [◀] or [▶] button to tune in the desired station.

Tuning

There are 3 types of tuning mode available, seek tuning, manual tuning and preset tuning.

Radio Operations

Seek tuning

1. Press the [BND] button and select the desired band (FM or AM).
 - * If "MANU" is lit in the display, press and hold the [BND] button for 1 second or longer. "MANU" in the display goes off and seek tuning is now available.
2. Press the [◀] or [▶] button to automatically seek a station.

When the [▶] button is pressed, the station is sought in the direction of higher frequencies; if the [◀] button is pressed, the station is sought in the direction of lower frequencies.

Manual tuning

There are 2 ways available: Quick tuning and step tuning.

When you are in the step tuning mode, the frequency changes one step at a time. In the quick tuning mode, you can quickly tune the desired frequency.

1. Press the [BND] button and select the desired band (FM or AM).
 - * If "MANU" is not lit in the display, press and hold the [BND] button for 1 second or longer. "MANU" is lit in the display and manual tuning is now available.
2. Tune into a station.

● Quick tuning:

Press and hold the [◀] or [▶] button for 1 second or longer to tune in a station.

● Step tuning:

Press the [◀] or [▶] button to manually tune in a station.

Recalling a preset station

A total of 24 preset positions (6-FM1, 6-FM2, 6-FM3, 6-AM) exists to store individual radio stations in memory. Pressing the corresponding [DIRECT] button recalls the stored radio frequency automatically.

1. Press the [BND] button and select the desired band (FM or AM).
2. Press the corresponding [DIRECT] button to recall the stored station.
 - * Press and hold one of the [DIRECT] buttons for 2 seconds or longer to store that station into preset memory.

Manual memory

1. Select the desired station with seek tuning, manual tuning or preset tuning.
2. Press and hold one of the [DIRECT] buttons for 2 seconds or longer to store the current station into preset memory.

Auto store

Auto store is a function for storing up to 6 stations that are automatically tuned in sequentially. If 6 receivable stations cannot be received, a previously stored station remains unoverwritten at the memory position.

1. Press the [BND] button and select the desired band (FM or AM).
2. Press and hold the [SC] button for 2 seconds or longer. The stations with good reception are stored automatically to the preset channels.

Preset scan

Preset scan receives the stations stored in preset memory in order. This function is useful when searching for a desired station in memory.

1. Press the [SC] button.
2. When a desired station is tuned in, press the [SC] button again to continue receiving that station.

Note:

- Be careful not to press and hold the [SC] button for 2 seconds or longer, otherwise the auto store function is engaged and the unit starts storing stations.

Instant station recall (ISR)

Instant station recall is a special radio preset that instantly accesses a favorite radio station at a touch of a button. The ISR function even operates with the unit in other modes.

● ISR memory

1. Select the station that you wish to store in ISR memory.
2. Press and hold the [ISR] button for 2 seconds or longer.

● Recalling a station with ISR

In any mode, press the [ISR] button to turn on the radio function and tune the selected radio station. "ISR" appears in the display. Press the [ISR] button again to return to the previous mode.

CD Operations

Loading a CD



1. Press the [O] button. The DUAL ACTION opens.

⚠ CAUTION

Be careful not to get your fingers caught when opening and closing the DUAL ACTION.

2. Press the [CD EJECT] button.
3. Insert a CD into the centre of the insertion slot with the label side facing up. The CD plays automatically after loading.

Notes:

- Never insert foreign objects into the CD insertion slot.
- If the CD is not inserted easily, there may be another CD in the mechanism or the unit may require service.
- Discs not bearing the  or  mark and CD-ROMs cannot be played by this unit.

Loading 8 cm compact discs

- * No adapter is required to play an 8 cm CD.
 - * Insert the 8 cm CD into the centre of the insertion slot.
4. After loading a CD, the DUAL ACTION closes automatically.

Notes:

- Note that DUAL ACTION closes immediately after a CD is inserted into CD insertion slot.
- If no CD is loaded in the DUAL ACTION, it closes after 30 seconds.

Listening to a CD already inserted

Press the [FNC] button to select the CD mode. Play starts automatically. If no CD is loaded in the unit, "NO DISC" appears in the display.

Pausing play

1. Press the [▶||] button to pause play. "PAUSE" appears in the display.
2. To resume CD play, press the [▶||] button again.

Ejecting a CD

1. Press the [O] button. The DUAL ACTION opens. Press the [CD EJECT] button to eject a CD. "EJECT" appears in the display.

⚠ CAUTION

Be careful not to get your fingers caught when opening and closing the DUAL ACTION.

2. Remove the CD and press the [O] button to close the DUAL ACTION.

Notes:

- Be sure to close the DUAL ACTION after removing the CD.
- The DUAL ACTION closes automatically 30 seconds after removing the CD.
- If a CD (12 cm) is left in the ejected position for 15 seconds, the CD is automatically reloaded. (Auto reload)
- 8 cm CDs are not auto reloaded. Be sure to remove it when ejected.
- If you force a CD into before auto reloading, this can damage the CD.
- When it fails in eject operation when the eject button is pressed down, fully press the eject button down again. (If the eject button operation is incomplete, it means that the Dual Action Mechanism is suspended, so do not perform other further operation without releasing the Dual Action Mechanism stopped midway.)

Selecting a track

● Track-up

1. Press the [▶▶] button to move ahead to the beginning of the next track.
2. Each time you press the [▶▶] button, the track advances ahead to the beginning of the next track.

● Track-down

1. Press the [◀◀] button to move back to the beginning of the current track.
2. Press the [◀◀] button twice to move to the beginning of the previous track.

Fast-forward/fast-backward

● Fast-forward

Press and hold the [▶▶] button for 1 second or longer.

● Fast-backward

Press and hold the [◀◀] button for 1 second or longer.

CD Operations

Top function

The top function resets the CD player to the first track of the disc. Press the **[BND]** button to play the first track (track No. 1) on the disc.

Scan play

The scan play locates and plays the first 10 seconds of each track on a disc automatically. This function continues on the disc until it is cancelled.

* The scan play is useful when you want to select a desired track.

1. Press the **[SC]** button to start scan play. "SCN" lights in the display.
2. To cancel the scan play, press the **[SC]** button again. "SCN" goes off from the display and the current track continues to play.

Repeat play

The repeat play continuously plays the current track. This function continues automatically until it is cancelled.

1. Press the **[RP]** button. "RPT" lights in the display and the current track is repeated.
2. To cancel the repeat play, press the **[RP]** button again. "RPT" goes off from the display and normal play resumes.

Random play

The random play selects and plays individual tracks on a disc in no particular order. This function continues automatically until it is cancelled.

1. Press the **[RD]** button. "RDM" lights in the display, an individual track is selected randomly and play begins.
2. To cancel the random play, press the **[RD]** button again. "RDM" goes off and normal play resumes.

Operations Common to Each Mode

Entering titles—DISC or STATION TITLE

Titles up to 10 characters long can be stored in memory and displayed for CD, CD changer and TV stations. The number of titles that can be entered for each mode are as follows.

Mode	Number of titles
CD mode	50 titles
TV mode	15 titles

CD changer mode	Number of titles
CDC655z connected	60 titles
CDC655Tz connected	100 titles
CDC1255z connected	50 titles

1. Press the **[FNC]** button to select the mode you want to enter a title (CD, CD changer or TV).
2. Select and play a CD in the CD changer or tune in to a TV station for which you want to enter the title.
3. Press the **[DISP]** button and display the main.
4. Press the **[TITLE]** button. "TITL" appears in the display and the cursor position flashes.
5. Press the **[◀]** or **[▶]** button to move the cursor.
6. Press the **[DISP]** button to select a character. Each time you press the **[DISP]** button, the character changes in the following order:
Capital letters → Small letters → Numbers and Symbols → Umlaut → Capital letters...
7. Turn the **[ROTARY]** knob to select the desired character. Turning the **[ROTARY]** knob clockwise moves the cursor to the next character; turning it counterclockwise moves the cursor to the previous character.
8. Repeat steps 5 to 7 to enter up to 10 characters for the title.
9. Press and hold the **[▶▶▶]** button for 2 seconds or longer to store the title into memory and cancel title input mode.

Operations Common to Each Mode

Entering titles—Adjusted Effect items title

You can give a title to the user memory of the AC-PII VSE POSITION and P.EQ that you have adjusted.

1. Select the adjustment mode in which you want to give a title.
2. Press the [BND] button to select the user preset side.
3. Press one of the [DIRECT] buttons to select the use memory to which you want to give a title.
4. Press the [TITLE] button.
5. Press the [◀] or [▶] button to move the cursor.
6. Press the [DISP] button to select the character. Each time you press the [DISP] button, the character changes in the following order: Capital letters → Small letters → Numbers and Symbols → Umlaut → Capital letter...
7. Turn the [ROTARY] knob clockwise or counterclockwise to adjust desired character.
8. Repeat steps 5 to 7 to enter up to 10 characters for the title.
9. Press and hold the the [▶▶▶] button for 2 second or longer to store the title into memory and cancel title input mode.

Clearing titles

1. Select and play a CD in the CD changer or tune in to a TV station for which you want to clear the title.
2. Press the [DISP] button and display the main.
3. Press the [TITLE] button. "TITL" appears in the display and the display switches to the title input display.
4. Press the [BND] button.
5. Press and hold the [▶▶▶] button for 2 seconds or longer to clear the title and cancel title input mode.

Dimmer Level

1. Press the [TITLE] button for 1 second or longer to enter ADJ mode.
2. Press the [◀] or [▶] button to select the "DIMMER LV".
3. Turn the [ROTARY] knob clockwise or counterclockwise to adjust Dimmer level.

4. Press the [TITLE] button to return to the previous mode.
 - * Adjustment range is off to LV5.
 - * Factory default setting is LV3.

Contrast

1. Press the [TITLE] button for 1 second or longer to enter ADJ mode.
2. Press the [◀] or [▶] button to select the "CONTRAST".
3. Turn the [ROTARY] knob clockwise or counterclockwise to adjust Contrast level.
4. Press the [TITLE] button to return to the previous mode.
 - * Adjustment range is LV1 to LV18
 - * Factory default setting is LV18.

Key Illumi

1. Press the [TITLE] button for 1 second or longer to enter ADJ mode.
2. Press the [◀] or [▶] button to select the "KEY ILLUMI".
3. Turn the [ROTARY] knob clockwise or counterclockwise to select Key illumi color.
4. Press the [TITLE] button to return to the previous mode.
 - * Selectable color is Green or Red.
 - * Factory default setting is Green.

Message display

When the unit is powered on or off, a message is displayed. The user can turn this message display ON or OFF.

* The factory default setting is "ON".

1. Press and hold the [TITLE] button for 1 second or longer to switch to the adjustment selection display.
2. Press the [◀] or [▶] button to select "MESSAGE".
3. Turn the [ROTARY] knob clockwise or counterclockwise to set the message display ON or OFF.
4. Press the [TITLE] button to return to the previous mode.

Operations Common to Each Mode

Beep

1. Press the [TITLE] button for 1 second or longer to enter ADJ mode.
2. Press the [◀] or [▶] button to select the "BEEP".
3. Turn the [ROTARY] knob clockwise or counterclockwise to switch Beep on or Beep off.
4. Press the [TITLE] button to return to the previous mode.
 - * Factory default setting is Beep on.

AUX function

This system has an external RCA input so you can listen to sounds and music from external devices connected to this unit.

Selecting AUX IN sensitivity

Make the following settings to select the sensitivity when sounds from external devices connected to this unit are difficult to hear even after adjusting the volume.

- * The factory default setting is "SENS LOW".
1. Press and hold the [TITLE] button for 1 second or longer to set the Adjust mode.
 2. Press the [◀] or [▶] button and select "AUX SENS".
 3. Turn the [ROTARY] knob clockwise or counterclockwise as needed and select from "SENS HIGH", "SENS MID" or "SENS LOW".
 4. Press the [TITLE] button to return to the previous mode.

Screen saver function

This unit is provided with the screen saver function which allows you to show various kinds of patterns and characters in the Operation Status indication area of the display. You can turn on and off this function.

If the button operation is performed with the screen saver function on, the operation display corresponding to the button operation is shown for about 30 seconds and the display returns to the screen saver display.

- * The factory default setting is "RANDOM".
1. Press the [TITLE] button for 1 second or longer to enter ADJ mode.
 2. Press the [◀] or [▶] button to select the "AUTO SS".
 3. Press [▶||] to enter the AUTO SS ADJ mode.

4. Turn the [ROTARY] knob clockwise or counterclockwise to select AUTO SS type or AUTO SS off.
5. Press the [TITLE] button to return to the previous mode.
 - SS type are SS OFF, SS PTN1, SS PTN2, SS PTN3, SS RANDOM

Displaying titles

This unit can display title data and user title data input with this unit.

1. Press the [DISP] button to display the title.
2. Each time you press and hold the [DISP] button for 1 second or longer, the title display changes.

Note:

The contents of the title to be displayed depend on a disc to be played.

If a disc with no title or user title input is played, "NO-TITLE" appears in the display.

Setting the method for Ttitle scroll

Set how to scroll in CD-TEXT or MD.

- * The factory default setting is "ON".
1. Press and hold the [TITLE] button for 1 second or longer to set the Adjust mode.
 2. Press the [◀] or [▶] button and select "AUTO SCROLL".
 3. Turn the [ROTARY] knob clockwise or counterclockwise and select "ON" or "OFF".
 - "SCROLL ON"
To scroll automatically.
 - "SCROLL OFF"
To scroll just 1 time when the title was changed or the title key was pressed.
 4. Press the [TITLE] button to return to the previous mode.

8. OPERATIONS OF ACCESSORIES

CD/MD/DVD Changer Operations

CD/MD/DVD changer functions

When an optional CD/MD/DVD changer is connected through the CeNET cable, this unit controls all changer functions. This unit can control a total of 2 changers (MD or CD or DVD).

Press the [FNC] button and select the CD/MD/DVD changer mode to start play. If 2 changers are connected, press the [FNC] button to select the changer for play.

- * If "NO MAGAZINE" appears in the display, insert the magazine into the changer. "LOADING" appears in the display while the player loads (checks) the magazine.
- * If "NO DISC" appears in the display, eject the magazine and insert discs into each slot. Then, reinsert the magazine back into the changer.

⚠ CAUTION

CD-ROM discs and CD-R discs cannot be played in the CD changer.

Pausing play

1. Press the [▶||] button to pause play. "PAUSE" appears in the display.
2. To resume play, press the [▶||] button again.

Selecting a DISC

Each [DIRECT] button corresponds to a disc loaded into the magazine.

● Selecting a disc from 1 to 6

Press the corresponding [DIRECT] button (1 to 6) to select the desired disc.

● Selecting a disc from 7 to 12 (only when a 12 disc CD changer is used.)

Press and hold the [DIRECT] button (1 to 6) for 1 second or longer to select the desired disc.

- * If a DISC is not loaded in a slot of magazine, pressing the [DIRECT] button corresponding to its disc number is invalid.

Selecting a track

● Track-up

1. Press the [▶▶] button to move ahead to the beginning of the next track.

2. Each time you press the [▶▶] button, the track advances ahead to the beginning of the next track.

● Track-down

1. Press the [◀◀] button to move back to the beginning of the current track.
2. Press the [◀◀] button twice to move to the beginning of the previous track.

Fast-forward/fast-backward

● Fast-forward

Press and hold the [▶▶] button for 1 second or longer.

● Fast-backward

Press and hold the [◀◀] button for 1 second or longer.

Top function

The top function plays from the first track or chapter of the disc.

● When playing a disc 1 to 6

Press the [DIRECT] button (1 to 6) with the same number as the DISC playing.

● When playing a disc 7 to 12 (only when a 12 disc CD changer is used.)

Press and hold for 1 second or longer the [DIRECT] button (1 to 6) with the same number as the DISC playing.

- * If a DISC is not loaded in a slot of magazine, pressing the [DIRECT] button corresponding to its disc number is invalid.

Scan play

Scan play locates and plays the first 10 seconds of each track on a disc automatically. This function continues on the disc until it is cancelled.

- * The scan play is useful when you want to select a desired track.

1. Press the [SC] button to start track scanning. "SCN" lights in the display.
2. To cancel the scan play, press the [SC] button again. "SCN" goes off from the display and the current track continues to play.

CD/MD/DVD Changer Operations

Disc scan play

Disc scan play locates and plays the first 10 seconds of the first track on each disc in the currently selected DISC changer. This function continues automatically until it is cancelled.

* Disc scan play is useful when you want to select a desired DISC .

1. Press and hold the **[SC]** button for 1 second or longer. “**DISC**” and “**SCN**” light in the display and disc scan play starts.
2. To cancel disc scan play, press the **[SC]** button again. “**DISC**” and “**SCN**” go off from the display and the current track continues to play.

Repeat play

Repeat play continuously plays the current track. This function continues automatically until it is cancelled.

1. Press the **[RP]** button. “**RPT**” lights in the display and the current track is repeated.
2. To cancel repeat play, press the **[RP]** button again. “**RPT**” goes off from the display and normal play resumes.

Disc repeat play

After all the tracks on the current disc have been played, disc repeat play automatically replays the current disc over from the first track. This function continues automatically until it is cancelled.

1. Press and hold the **[RP]** button for 1 second or longer. “**DISC**” and “**RPT**” light in the display and disc repeat play starts.
2. To cancel disc repeat play, press and hold the **[RP]** button again. “**DISC**” and “**RPT**” go off from the display and normal play resumes on the current track.

Random play

Random play selects and plays individual tracks on the disc in no particular order. This function continues automatically until it is cancelled.

1. Press the **[RD]** button. “**RDM**” lights in the display and random play begins.
2. To cancel random play, press the **[RD]** button again. “**RDM**” goes off from the display and normal play resumes.

Disc random play

The disc random play selects and plays individual tracks or discs automatically in no particular order. This function continues automatically until it is cancelled.

1. Press and hold the **[RD]** button for 1 second or longer. “**DISC**” and “**RDM**” light in the display and disc random play starts.
2. To cancel disc random play, press and hold the **[RD]** button again. “**DISC**” and “**RDM**” go off from the display and normal play resumes from the current track.

TV Operations

TV tuner functions

When an optional TV tuner is connected through the CeNET cable, this unit controls all TV tuner functions. To watch TV requires a TV tuner and monitor.

Watching a TV

1. Press the [FNC] button and select the TV mode.
2. Press the [BND] button to select the desired TV band (TV1 or TV2). Each time the button is pressed, the input selection toggles between TV1 and TV2.
3. Press the [◀] or [▶] button to tune in the desired TV station.

Watching a video

The TV tuner has a VTR input terminal to which 1 external device can be connected. Connect a 12 V video cassette player (VCP) or video cassette recorder (VCR) to the TV tuner input terminal.

1. Press the [RD] button to select VTR.
2. To return to the TV broadcast, press the [RD] button.

Tuning

There are 3 types of tuning mode available, Seek tuning, manual tuning and preset tuning.

Seek tuning

1. Press the [BND] button and select the desired TV band (TV1 or TV2).
 - * If "MANU" is lit in the display, press and hold the [BND] button for 1 second or longer. "MANU" in the display goes off and seek tuning is now available.
2. Press the [◀] or [▶] button to automatically seek a station.

Press the [▶] button to automatically tune up the frequency band to the next available TV station; press the [◀] button to automatically tune down.

Manual tuning

There are 2 ways available: Quick tuning and step tuning.

When you are in the step tuning mode, the frequency changes one step at a time. In the quick tuning mode, you can quickly tune the desired frequency.

1. Press the [BND] button and select the desired band (TV1 or TV2).
 - * If "MANU" is not lit in the display, press and hold the [BND] button for 1 second or longer. "MANU" lights in the display and manual tuning is now available.
2. Tune into a station.

●Quick tuning:

Press and hold the [◀] or [▶] button for 1 second or longer to tune in a station.

●Step tuning:

Press the [◀] or [▶] button to manually tune in a station.

Recalling a preset station

A total of 12 TV stations can be stored (6-TV1 and 6-TV2). This allows you to select your favorite TV stations and store them in memory for later recall.

1. Press the [BND] button and select the desired TV band (TV1 or TV2).
2. To recall a stored TV station, press the desired [DIRECT] button to select that station.
 - * Press and hold one of the [DIRECT] buttons for 2 seconds or longer to store the current station into preset memory.

Manual memory

1. Select the desired station with seek tuning, manual tuning or preset tuning.
2. Press and hold one of [DIRECT] buttons for 2 seconds or longer to store the current station into preset memory.

Auto store

Auto store selects 6 TV stations automatically and stores each one into preset memory.

If there are not 6 stations with good reception, stations previously stored in memory remain and only the strong stations are stored into memory.

TV Operations

1. Press the [BND] button and select the desired TV band (TV1 or TV2).
2. Press and hold the [SC] button for 2 seconds or longer. The stations with good reception are stored automatically to the preset channels.

Preset scan

Preset scan allows the user to view each preset position before it automatically advances to the next preset. This function is useful for searching for a desired TV station in memory.

1. Press the [SC] button.
2. When the desired station is found, press the [SC] button again to remain tuned to that station.

Note:

- Do not press and hold the [SC] button for 2 seconds or longer. Doing so will trigger the auto store function and start storing stations into memory.

Setting the TV diver

You can change the reception setting for the TV antenna connected to the TV tuner.

1. Press and hold the [TITLE] button for 1 second or longer to switch to the adjustment selection display.
2. Press the [◀] or [▶] button to select "TV DIVER".
3. Turn the [ROTARY] knob clockwise to set to "ON" or counterclockwise to set to "OFF".
 - "DIVER ON"

Sets reception emphasizing the visual.
 - "DIVER OFF"

Sets the diver setting to OFF.
4. Press the [TITLE] button to return to the previous mode.

Digital Radio / DAB Operations

DAB control function

When a CeNET cable is used to connect a DAB (DAH913) (sold separately), all functions can be operated.

Listening to the DAB station

1. Press the [FNC] button to select the DAB mode.
2. When the unit receives a DAB station, the display changes in the following order:
Frequency channel → service label

Switching displays

Press the [DISP] button for 1 second during the Main (service label) display to select Main (service label) or Sub (PTY).

Notes:

- The display shown in the normal reception mode and the preset reception mode is the same when a DAB station is received.
- The number of programmes and broadcasting times depend on the DAB stations.
- When the strength of DAB signals is weak, audio output is muted.

Seek tuning

1. Press the [FNC] button to select the DAB mode.
2. Press and hold the [◀] or [▶] button for 1 second or longer.
 - * "SEARCHING" appears in the display.
3. "DAB" lights up in the display when the main unit receives a DAB station.
 - * The main unit stops the seek tuning when it cannot find a DAB station. The display returns to the previous mode.

Manual tuning

1. Press the [FNC] button to select the DAB mode.
2. Press and hold the [BND] button for 1 second or longer. "MANU" lights up in the display.
3. Press the [◀] or [▶] button to select a station.
 - * If no operation is performed for more than 7 seconds, manual tuning is cancelled and the display returns to the previous mode.

Switching programmes

1. Press the [FNC] button to receive a DAB station.
2. Press the [◀] or [▶] button to switch programmes in the DAB station.

Note:

- The programme name may be the same depending on DAB programmes.

Programme scan

This function scans through each receivable programme in a DAB station being received for 10 seconds sequentially. This is useful when you want to search for a desired programme.

1. Press the [FNC] button to receive a DAB station.
2. Perform the following operation depending on the connected model.

Press the [SC] button. "SERVICE SCN" lights up and the unit starts scanning each programme for 10 seconds sequentially. Each time the main unit scans, the programme name is shown in the display.

3. To stop programme scan when a desired programme is tuned in.
Press the [SC] button.

Manual memory

The main unit has a manual memory function for DAB programmes. Up to 18 programmes (6 programmes each) can be preset in the preset buttons.

[M1], [M2] and [M3]

1. Press the [FNC] button to select DAB mode.
2. Press the [BND] button to select any one shown above.
3. Press the [◀] or [▶] button to select a desired programme.
4. Press and hold one of the [DIRECT] buttons (1 to 6) for 2 seconds or longer to store the programme.

Note:

- The interrupt programme (PTY or INFO) cannot be written into a manual memory.

Recalling a preset programme

1. Press the [FNC] button to select the DAB mode.
2. Press the [BND] button. Each time you press the [BND] button, the display changes in the following order:
[M1] → [M2] → [M3] → [M1]...
3. Press one of the [DIRECT] buttons to recall a preset programme.

Note:

- Press and hold the [DIRECT] button for 2 seconds or longer to store the programme currently being received. (Manual memory)

AF function

The AF function switches to a different frequency on the same network in order to maintain optimum reception.

* The factory default setting is "ON"

● Switching OFF the AF function

Press the [RP] button. "AF" in the display goes off and the AF function turns off.

● Switching ON the AF function

Press the [RP] button. "AF" in the display lights and the AF function turns on.

* If the reception of the current broadcast station deteriorates, "SEARCHING SAME STATION" "SEARCH" appears in the display and the radio searches for the same programme on another frequency.

INFO (Announcement)

In the INFO standby mode, when the selected announcement programme starts, the main unit switches to the selected announcement programme automatically.

● Setting the INFO standby mode

If you press and hold the [ISR] button for 1 second or longer, "INFO" lights in the display and the main unit is set into the INFO standby mode until the selected announcement is broadcast. When the selected announcement broadcast starts, the announcement item appears in the display. If you press and hold the [ISR] button for 1 second or longer while the selected announcement broadcast is being received, the selected announcement broadcast reception is cancelled and the main unit goes into the INFO standby mode.

● Cancelling INFO standby mode

To cancel the INFO standby mode, press and hold the [ISR] button for 1 second or longer.

● Information select

This is a function for selecting INFORMATION ON or OFF in the Information interrupt mode.

You can set ON up to 6 information items.

You can select any of the 6 items below:

INFORMATION item	
ENGLISH	Contents
TRAVEL	Transport flash
WARNING	Warning / Service
NEWS	News flash
WEATHER	Area weather flash
EVENT	Event announcement
SPECIAL	Special event

1. Perform the following operation depending on the connected model.
Press and hold the [TITLE] button for 1 second or longer.
2. Press the [◀] or [▶] button to select "INFO SEL", then press the [▶] button to enter "INFO SEL" mode.
3. Press the [◀] or [▶] button to select an information item. You can select any of 6 items:
4. Perform the following operation depending on the connected model.
Turn the [ROTARY] knob clockwise or counterclockwise to set the information item for ON or OFF.
5. Press the [TITLE] button to return to the previous display.

Switching the PTY display language

You can select one of 2 languages (English or French) for the PTY displayed in the display.

- * The factory default setting is "ENGLISH".
1. Press and hold the [TITLE] button for 1 second or longer to switch to the adjustment selection display.
 2. Press the [◀] or [▶] button and select "LANGUAGE".
 3. Turn the [ROTARY] knob clockwise or counterclockwise to select the desired language.
 4. Press the [TITLE] button to return to the previous mode.

TA (Traffic Announcement)

In the TA standby mode, when a traffic announcement broadcast starts, the traffic announcement broadcast is received as top priority regardless of the function mode. Traffic programme (TP) automatic tuning is also possible.

- * This function can only be used when "TP" is lit in the display. When "TP" is lit, this means that the DAB broadcast station being received has traffic announcement programmes.

● Setting TA standby mode

If you press the [ISR] button when only "TP" is lit in the display, "TP" and "TA" light in the display and the unit is set into TA standby mode until a traffic announcement is broadcast. When a traffic announcement broadcast starts, "TRA INFO" appears in the display. If you press the [ISR] button while a traffic announcement broadcast is being received, the traffic announcement broadcast reception is cancelled and the unit goes into TA standby mode.

● Cancelling TA standby mode

With "TP" and "TA" lit in the display, press the [ISR] button. The "TA" in the display goes off and TA standby mode is cancelled.

- * If "TP" is not lit, pressing [ISR] button searches for a TP station.

● Searching for a TP station

When "TP" is not lit, if you press the [ISR] button, "TA" in the display lights and the unit automatically receives a TP station.

Note:

- If a TP station is not received, the unit continues the search operation. Pressing the [ISR] button again goes off "TA" in the display and stops TP station searching.

Auto store function for TP stations

You can automatically store up to 6 TP stations into preset memory. If the number of TP that can be received is less than 6, broadcast stations already stored in memory are left without being overwritten.

With "TA" lit in the display, press and hold the [SC] button for 2 seconds or longer. The TP stations with the good reception sensitivity are stored into preset memory.

- * Even if you select FM1 or FM2, a TP station is stored into memory for FM3.

PTY

This function enables you to listen to the selected programme type, irrespective of the function mode.

- * PTY broadcasts are not yet available in all countries.
- * In the INFO standby mode, INFO stations have priority over PTY stations.
- * In the TA standby mode, TP stations have priority over PTY stations.

PTY item	
ENGLISH	Contents
NEWS	News
INFORM	Information
SPORTS	Sports
TALK	Talk
ROCK	Rock
CLS ROCK	Classic Rock
ADLT HIT	Adult Hits
SOFT RCK	Soft Rock
TOP 40	Top 40
COUNTRY	Country music
OLDIES	Oldies
SOFT	Soft music
NOSTALGA	Nostalgia
JAZZ	Jazz
CLASSICL	Classical
R & B	Rhythm and Blues
SOFT R&B	Soft Rhythm and Blues
LANGUAGE	Language
REL MUSC	Religious music
REL TALK	Religious talk
PERSNLTY	Personality
PUBLIC	Public

● Setting PTY standby mode

When you press the [RD] button, "PTY" lights in the display and the PTY standby mode is turned on. When the selected PTY broadcast starts, the PTY item name appears in the display.

● Cancelling PTY standby mode

When you press and hold the [RD] button for 1 second or longer, "PTY" goes off in the display and PTY standby mode is cancelled.

● Cancelling a PTY interrupt broadcast

Press the [RD] button during the PTY interrupt broadcast, the PTY interrupt is cancelled and the unit returns to PTY standby mode.

Selecting PTY

1. When you press the [RD] button, the unit goes into PTY select mode.
2. Press any one of the [DIRECT] buttons. Alternatively, turn the [ROTARY] knob clockwise or counterclockwise to select the desired PTY.
 - * Below are the factory default settings stored for the [DIRECT] buttons.

Preset number	PTY item	
	ENGLISH	Contents
1	NEWS	News
2	TOP 40	Top 40
3	COUNTRY	Country music
4	SOFT	Soft music
5	CLASSICL	Classical
6	R & B	Rhythm and Blues

3. The PTY select mode is cancelled automatically 7 seconds after a PTY is selected.

PTY seek

1. When you press the [RD] button, the PTY select mode is turned on.
2. Select PTY.
3. Press the [◀] or [▶] button. If you press the [▶] button, the unit seeks a PTY broadcast moving up the frequencies; if you press the [◀] button, it seeks moving down the frequencies.
 - * If no station with the selected PTY broadcast can be received, the unit returns to PTY select mode.

PTY preset memory

1. When you press the [RD] button, the PTY select mode is turned on.
2. Turn the [ROTARY] knob clockwise or counterclockwise to select the desired PTY.
3. If you press and hold any one of the [DIRECT] buttons for 2 seconds or longer, the selected PTY is stored into that preset channel memory.

Emergency broadcast

When an emergency broadcast is received, all the function mode operations are stopped. "ALARM" appears in the display and the emergency broadcast can be heard.

Digital Radio / DAB Operations

● **Canceling an emergency broadcast**

If you press [RP] button, emergency broadcast reception is cancelled.

Volume setting of TA, INFO, emergency broadcast (ALARM) and PTY

The volume for TA, INFO, ALARM and PTY interrupts can be set during TA, INFO, ALARM and PTY interrupt. Perform the following operation depending on the connected model.

* The factory default setting is "15".

During a TA, INFO, ALARM or PTY interrupt, turn the [ROTARY] knob clockwise or counter-clockwise to set the volume to a desired level (0 to 33).

* When the TA, INFO, ALARM or PTY interrupt ends, the volume returns to the level it had before the interrupt.

DVD DECK Operations

Operation

● **Play/Still operation**

Press the [▶||] button to select the desired mode (play, still (pause)).

Each time the button is pressed, the mode changes cyclically.

● **Chapter up/down operation (FF/FB operation)**

Press the [▶▶] button for 1 second or shorter to increment chapters.

Hold down the [▶▶] button for 1 second or longer to fast forward.

Press the [◀◀] button for 1 second or shorter to decrement chapters.

Hold down the [◀◀] button for 1 second or longer to fast backward.

9. IN CASE OF DIFFICULTY

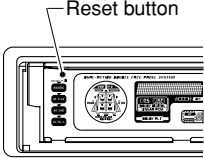
	Problem	Cause	Measure
General	Power does not turn on. (No sound is produced.)	Fuse is blown.	Replace with a fuse of the same amperage. If the fuse blows again, consult your store of purchase.
		Incorrect wiring.	Consult your store of purchase.
	No sound output when operating the unit with amplifiers or power antenna attached.	Power antenna lead is shorted to ground or excessive current is required for remote-on the amplifiers or power antenna.	<ol style="list-style-type: none"> 1. Turn the unit off. 2. Remove all wires attached to the power antenna lead. Check each wire for a possible short to ground using an ohm meter. 3. Turn the unit back on. 4. Reconnect each amplifier remote wire to the power antenna lead one by one. If the amplifiers turn off before all wires are attached, use an external relay to provide remote-on voltage (excessive current required).
	Nothing happens when buttons are pressed. Display is not accurate.	The microprocessor has malfunctioned due to noise, etc.	Turn off the power, then press the [RELEASE] button and remove the DCP. Press the reset button with a thin rod. 
		DCP or main unit connectors are dirty.	Wipe the dirt off with a soft cloth moistened with cleaning alcohol.
CD	Compact disc cannot be loaded.	Another compact disc is already loaded.	Eject the compact disc before loading the new one.
	Sound skips or is noisy.	Compact disc is dirty.	Clean the compact disc with a soft cloth.
		Compact disc is heavily scratched or warped.	Replace with a compact disc with no scratches.
Sound is bad directly after power is turned on.	Water droplets may form on the internal lens when the car is parked in a humid place.	Let dry for about 1 hour with the power on.	
DSP	Poor sound quality	The equalizer levels are too high.	If the equalizer levels are too high, the sound may distort. Lower the equalizer levels.

10. ERROR DISPLAYS

If an error occurs, one of the following displays is displayed.
Take the measures described below to eliminate the problem.

	Error Display	Cause	Measure
CD	ERROR 2	A CD is caught inside the CD deck and is not ejected.	This is a failure of CD deck's mechanism and consult your store of purchase.
	ERROR 3	A CD cannot be played due to scratches, etc.	Replace with a non-scratched, non-warped-disc.
		A CD cannot be played due to pick up failure.	Consult your store of purchase.
	ERROR 6	A CD is loaded upside-down inside the CD deck and does not play.	Eject the disc then reload it properly.
CD changer	ERROR 2	A CD inside the CD changer is not loaded.	This is a failure of CD changer's mechanism and consult your store of purchase.
	ERROR 3	A CD inside the CD changer cannot be played due to scratches, etc.	Replace with a non-scratched, non-warped disc.
		A CD cannot be played due to pick up failure.	Consult your store of purchase.
	ERROR 6	A CD inside the CD changer cannot be played because it is loaded upside-down.	Eject the disc then reload it properly.
MD changer	ERROR H	Displayed when the temperature in the MD changer is too high and playback has been stopped automatically.	Lower the surrounding temperature and wait for a while to cool off MD changer.
	ERROR 2	An MD inside the MD changer is not loaded.	This is a failure of MD changer's mechanism and consult your store of purchase.
	ERROR 3	An MD inside the MD changer cannot be played due to scratches, etc.	Replace with a non-scratched, non-warped disc.
	ERROR 6	An MD inside the MD changer cannot be played because it is loaded upside-down.	Eject the disc then reload it properly.
		Displayed when a non-recorded MD is loaded in the MD changer.	Load a pre-recorded MD in the MD changer.

	Error Display	Cause	Measure
DVD changer	ERROR 2	A DISC inside the DVD changer cannot be played.	This is a failure of dvd mechanism and consult your store of purchase.
	ERROR 3	A DISC cannot be played due to scratches, etc.	Retry or replace with a non-scratched, non-warped-disc.
	ERROR 6	A DISC inside the DVD changer cannot be played because it is loaded upside-down.	Eject the disc then reload it properly
	ERROR P	Parental level error	Set the correct Parental level.
	ERROR R	Region code error	Eject the disc and replace correct region code disc.

If an error display other than the ones described above appears, press the reset button. If the problem persists, turn off the power and consult your store of purchase.

Free Manuals Download Website

<http://myh66.com>

<http://usermanuals.us>

<http://www.somanuals.com>

<http://www.4manuals.cc>

<http://www.manual-lib.com>

<http://www.404manual.com>

<http://www.luxmanual.com>

<http://aubethermostatmanual.com>

Golf course search by state

<http://golfingnear.com>

Email search by domain

<http://emailbydomain.com>

Auto manuals search

<http://auto.somanuals.com>

TV manuals search

<http://tv.somanuals.com>