

Owner's manual & Installation manual
Mode d'emploi et manuel d'installation
Manual de instrucciones y de instalación

VRX485VD

MAX385VD

**MULTIMEDIA STATION &
7-inch TOUCH PANEL CONTROL**
STATION MULTIMEDIA DVD AVEC COMMANDE
PAR ECRAN TACTILE 7 pouces
**EQUIPO DVD MULTIMEDIA y
PANEL DE CONTROL TÁCTIL DE 7 pulgadas**

**2-DIN DVD MULTIMEDIA STATION &
6.5-inch TOUCH PANEL CONTROL**
STATION MULTIMEDIA DVD 2 DIN AVEC COMMANDE
PAR ECRAN TACTILE 6.5 pouces
**EQUIPO DVD MULTIMEDIA 2-DIN y
PANEL DE CONTROL TÁCTIL DE 6.5 pulgadas**

CLARION PRODUCT REGISTRATION INFORMATION

For USA and Canada only
www.clarion.com

Dear Customer:

Congratulations on your purchase of a Clarion mobile electronic product. We are confident that you'll enjoy your Clarion experience.

There are many benefits to registering your product. We invite you to visit our website at www.clarion.com to register your Clarion product.

We have made product registration simple with our easy to use website. The registration form is short and easy to complete. Once you're registered, we can keep you informed of important product information.

Register at www.clarion.com - it's easy to keep your Clarion product up to date.

Contents

1. FEATURES	3
Expanding Systems.....	3
2. PRECAUTIONS	4
3. CONTROLS/COMMANDES/CONTROLES	5
Names of Buttons	6
Outline of Button and Touchkey Operation	7
Remote Control	10
Functions of Remote Control Unit Buttons	11
4. CAUTIONS ON HANDLING	13
Operation panel	13
Cleaning	13
Handling Discs	14
5. DVD VIDEO SYSTEM	15
DVD Video Features	15
Discs.....	16
About the registered marks etc.	16
6. OPERATIONS	17
Basic Operations	18
Radio Operations	21
DVD Video Player Operations	22
7. ACCESSORIES	31
iPod Operations.....	31
AUX In Operations	32
Sirius Radio Operations.....	33
8. TROUBLESHOOTING	35
9. ERROR DISPLAYS	36
10. SPECIFICATIONS	37
INSTALLATION AND WIRE CONNECTION MANUAL	38

1. FEATURES

- Motorized 7" Widescreen LCD
- Double Din Motorized 6.5" Widescreen LCD
- Touch Panel Control
- DVD Video/CD-DA/MP3/WMA Playback Capability
- RCA 6-Channel Output
- CD-R/CD-RW/DVD±R/DVD±RW Compatible
- Built-in 40 W x 4 Amplifier
- iPod® Control

"iPod" is a trademark of Apple Computer, Inc., registered in the U.S. and other countries.



Expanding Systems

Expanding audio features

Satellite Radio
(SIRIUS: SC-C1)

Expanding visual features

Rear monitor

iPod

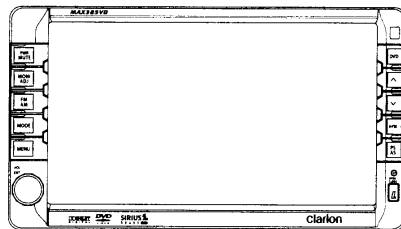
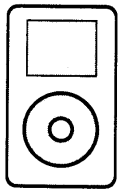

VTR etc.

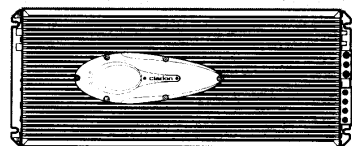
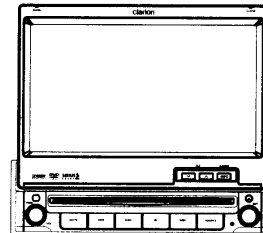
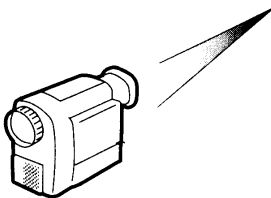

External Power Amplifiers

Expanding sound features

Note:

The items listed outside of the frames are the commercial products generally sold.

2. PRECAUTIONS

⚠ WARNING

For your safety, the driver should not watch any video sources and/or operate the controls while driving. Please note that watching and operating any video sources while driving are prohibited by law in some countries. Also, while driving, keep the volume to a level at which external sounds can be heard.

1. When the inside of the car is very cold and the player is used soon after switching on the heater, moisture may form on the disc (DVD/CD) or the optical parts of the player and proper playback may not be possible. If moisture forms on the disc (DVD/CD), wipe it off with a soft cloth. If moisture forms on the optical parts of the player, do not use the player for about one hour. The condensation will disappear naturally allowing normal operation.
2. Driving on extremely bumpy roads which cause severe vibration may cause the sound to skip.
3. This unit uses a precision mechanism. Even in the event that trouble arises, never open the case, disassemble the unit, or lubricate the rotating parts.
4. This equipment has been tested and found to comply with the limits for a Class B digital device, pursuant to Part 15 of the FCC Rules. These limits are designed to provide reasonable protection against harmful interference in a residential installation. This equipment generates, uses, and can radiate radio frequency energy and, if not installed and used in accordance with the instructions, may cause harmful interference to radio communications. However, there is no guarantee that interference will not occur in a

particular installation. If this equipment does cause harmful interference to radio or television reception, which can be determined by turning the equipment off and on, the user is encouraged to consult the dealer or an experienced radio/TV technician for help.

**INFORMATION FOR USERS:
CHANGES OR MODIFICATIONS TO THIS
PRODUCT NOT APPROVED BY THE
MANUFACTURER WILL VOID THE
WARRANTY AND WILL VIOLATE FCC
APPROVAL.**

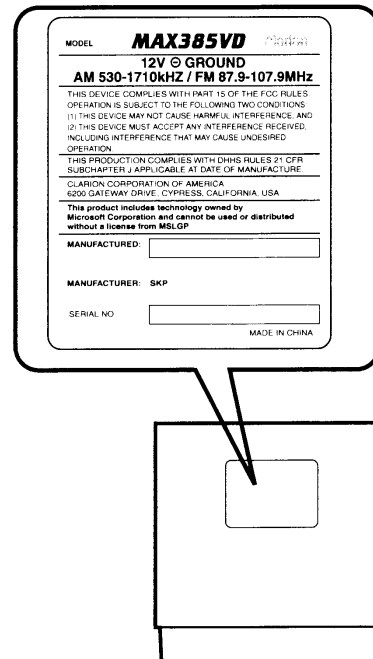

3. CONTROLS

● Operation panel

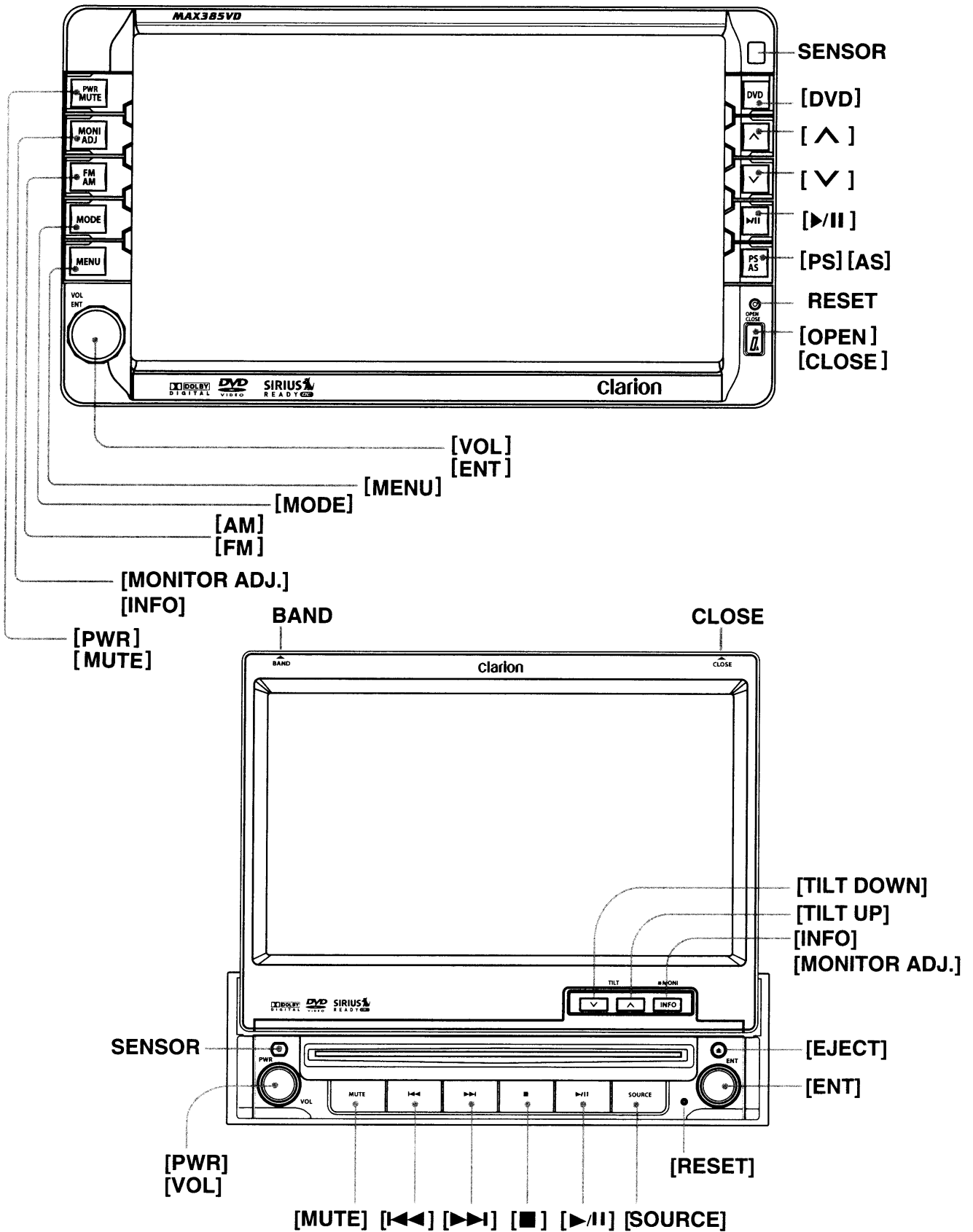

Note:

Be sure to read this chapter while referring to the front diagrams for chapter "3. CONTROLS" on page 5 (unfold).

[POWER/MUTE] Button

- Press this button to turn on the power. Keep pressing this button more than 1 second to turn off the power.
- Press this button to attenuate the sound of the receiver, press again to restore sound.

[\nearrow] OPEN/CLOSE Button

- Use this button to open/close the operation panel.
- Keep pressing this button more than 2 seconds to adjust the angle of the operation panel. The angle of the operation panel is adjustable in the range of 0° to 30°. (MAX385VD only)

Sensor

- Receiver for the remote control unit (operating range: 30° in all directions).

[AM/FM] Button

- Use this button to enter the AM/FM tuner mode from any source.
- Once in the AM/FM tuner mode, you can press it to change bands between FM1, FM2, FM3, and AM bands.

[Reset] Button

- Press this button to reset the unit.

[MONI/ADJ] button

- Press this button to enter/exit the playback information mode while in DVD mode.
- Keep pressing this button more than 1 second to enter/exit the Monitor Adjust mode.

[Mode] Button

Press this button to scroll through the available sources such as AM/FM tuner, DVD mode, AV input, Sirius Radio, and iPod mode.

[▶/||] Button

- Press this button to enter the play pause mode in the DVD/CD/MP3/WMA, and iPod modes. Press the button again to resume playback.

[\wedge], [\vee] [\ll] [\gg] Buttons

- Use these buttons to change to the previous/next preset station in the TUNER/Sirius Radio modes.
- Use these buttons to select a track in the CD, MP3/WMA, and iPod modes.
- Use these buttons to select a chapter in the DVD video mode.

[BAND] Button

- Use this button to enter the AM/FM tuner mode from any source.
- Once in the AM/FM tuner mode, you can press it to change bands between FM1, FM2, FM3, and AM bands.

[MENU] Button

- Pressing this button in the any mode will return the unit to the main menu.
- The main menu allows selection of any available source to included AM/FM tuner, DVD mode, AV input, Sirius radio, and iPod mode. The main menu also has a MONITOR OFF function to turn off the display to reduce glare or distraction while driving.
- The SETTING menu is also located in the main menu. Please do not make adjustments to the setting menu while the vehicle is in motion.

[DVD] Button

- Press this button to enter the DVD mode from any source.

[AS/PS] Button

- Press this button to start the preset scan mode.
- Press and hold this button to start the auto preset scan and setting mode. This function is very useful when traveling to unfamiliar areas.

[\blacktriangle] (EJECT) Button

- Use this button to eject the disc set in this unit.

Outline of Button and Touchkey Operation

Turning the power on

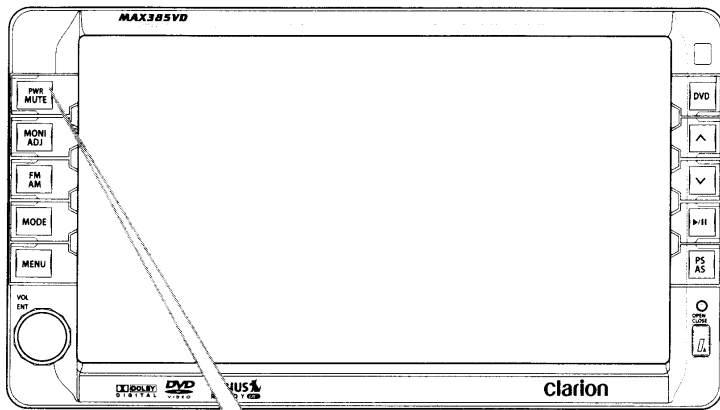

POWER

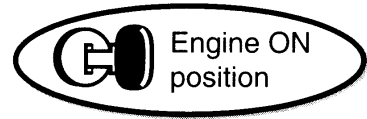

PWR MUTE

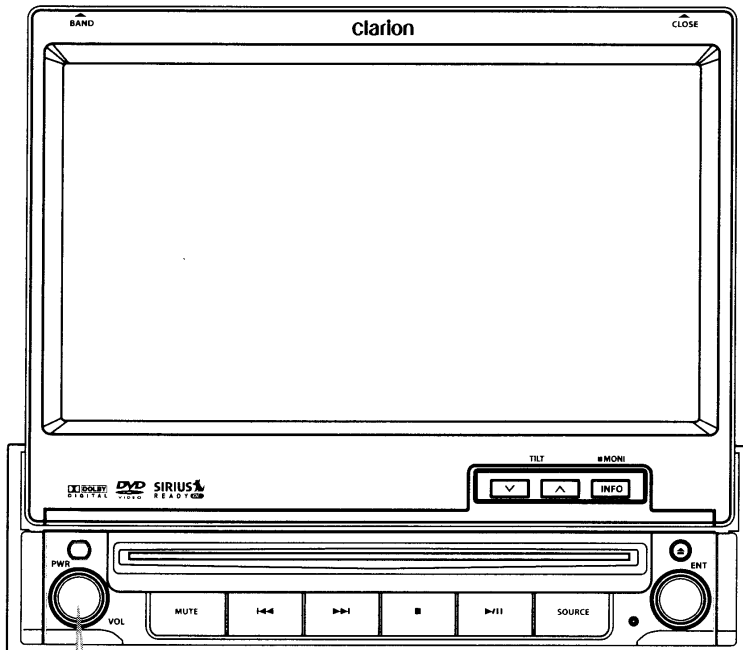
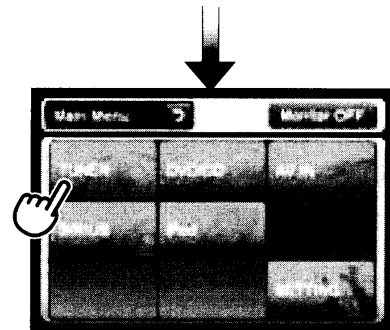
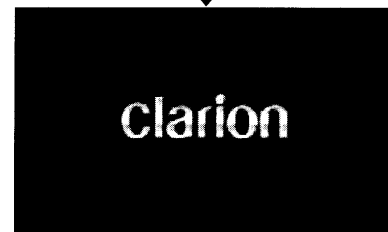

POWER

TUNER mode operation

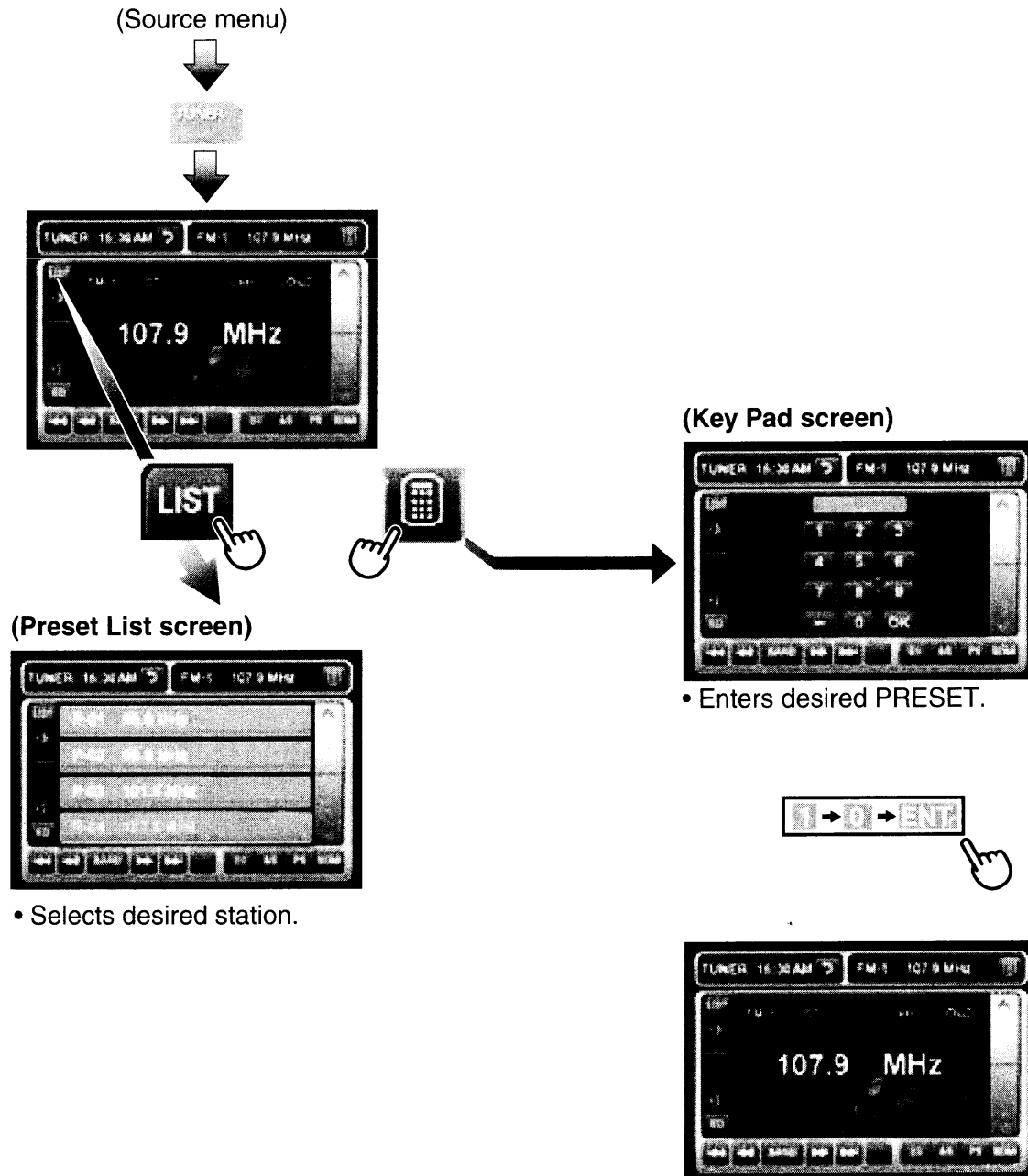

Note:

*1: These images indicate the buttons to press or keys to touch.

Outline of Button and Touchkey Operation

DVD Video mode operation

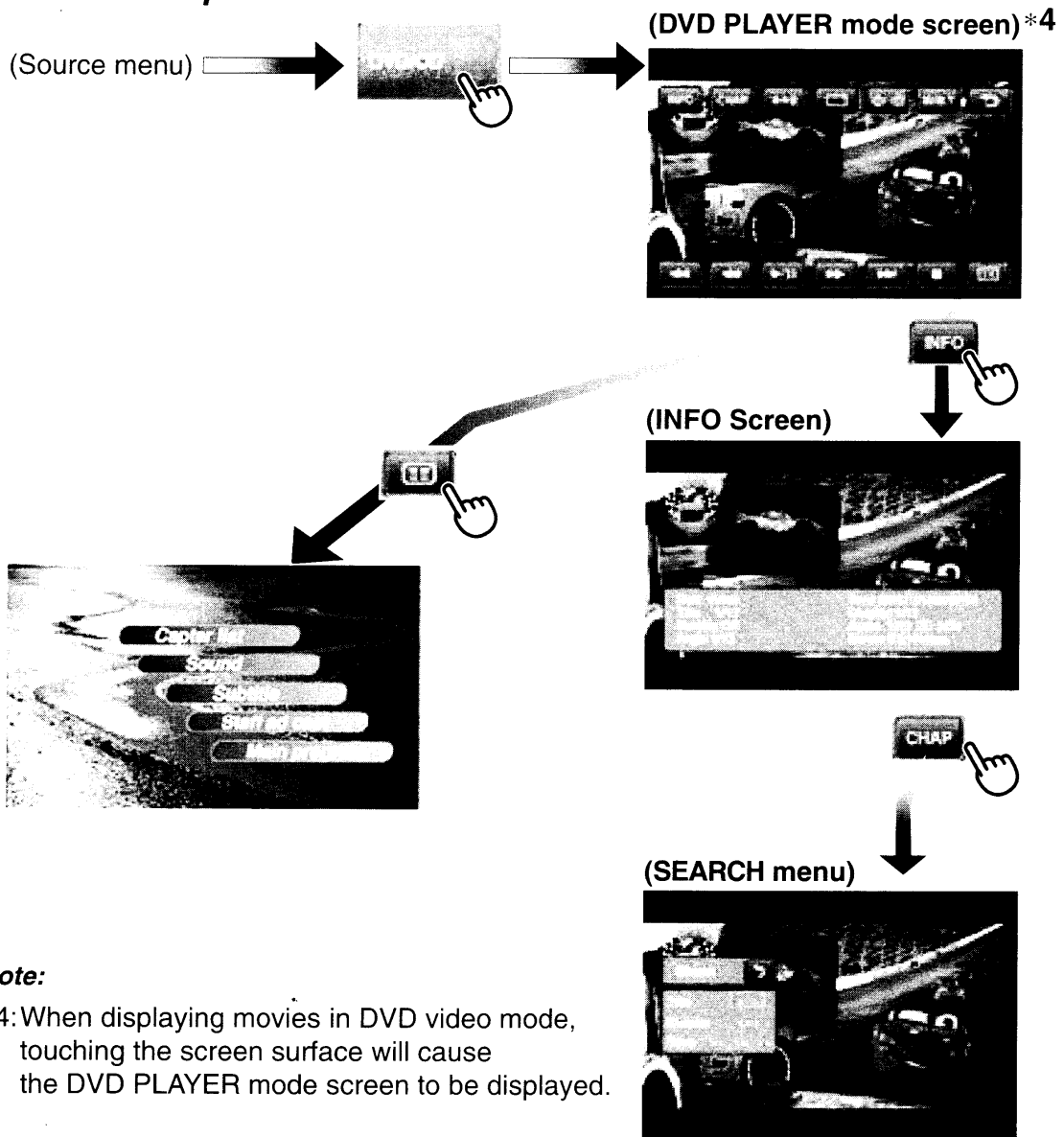

Adjusting audio/video settings

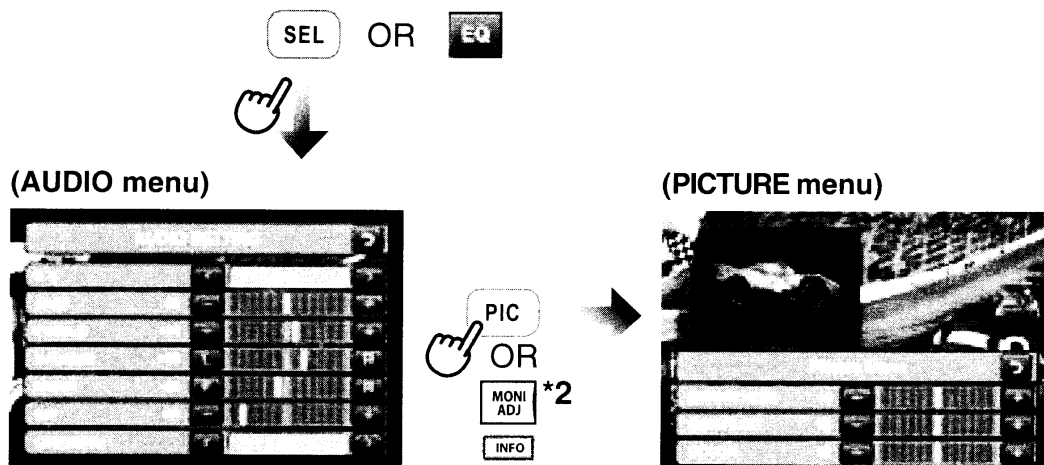

*2: Press and hold button to access setting menu.

Remote control unit

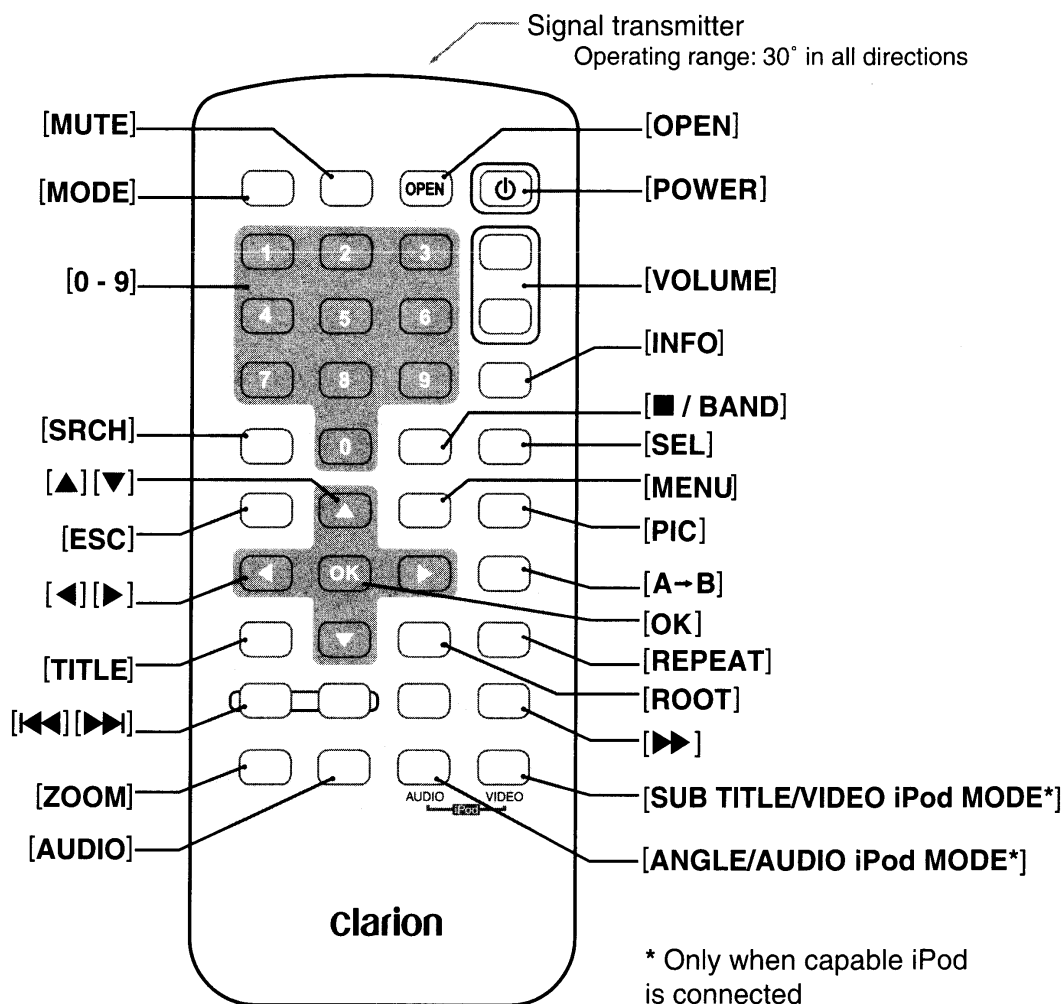

Replacing the Batteries

1. Press the retention tab and pull out the battery tray and remove the old battery.
2. Insert the new CR2025 battery and slide the battery tray back in the remote control the same direction that you removed it. Please ensure the tray is inserted in the correct direction.

Note:

Using batteries improperly can cause them to explode. Take note of the following points:

- When replacing batteries, replace both batteries with new ones.
- Do not short-circuit, disassemble or heat batteries.
- Do not dispose of batteries into fire or flames.
- Dispose of spent batteries properly.

Functions of Remote Control Unit Buttons

You can use the remote control unit to control the MAX385VD and VRX485VD.

Note:

- The wireless remote control operation may not be optimal in direct sunlight.

Shared modes

[MODE] button

- Press this button to scroll through the various available sources such as the AM/FM tuner, DVD player, iPod, Sirius Radio, or AUX IN.

[VOLUME] buttons

- Increase and decrease volume.

[MUTE] button

- Turns mute on and off.

[POWER] button

- Press this button to turn the unit on or off. menu screens.

[OPEN] button

- Press this button to OPEN or CLOSE the motorized screen. Please ensure there are no obstructions before starting the operation.

[MENU] button

- Press this button to enter the MAIN MENU. From the main menu, you can select your desired source or change your settings.

[PIC] button

- Press this button to change your monitor settings such as Brightness, Color, and Contrast.

[SEL] button

- Press this button to change your audio settings such as Tone, Fader, and Balance.

[ESC] button

- Press this button to exit selection and adjustment menus.

TUNER/Satellite Radio mode

[BAND] button

- Switches reception band.

[0 - 9] buttons

- Use in the Key Pad screen to set the radio frequency or Satellite Radio channels.
- Use to select the preset number in the Preset List screen.

[SEARCH] button

- Press to show/hide the Key Pad screen.

[OK] button

- Press to fix the entered data in the Key Pad screen.

[◀◀], [▶▶] buttons

- Press to seek the next available higher or lower station in TUNER mode. In Sirius Radio mode, you will scroll through the categories.

[◀◀], [▶▶] buttons

- Press to manually select the next higher or lower station in TUNER and Satellite Radio modes.

[▲], [▼] buttons

- Press to scroll through the saved presets in the TUNER mode. Press [OK] to tune to the highlighted preset.

[INFO] button

- Press to switch in and out of the LIST mode while in the TUNER/ Sirius Radio mode.

DVD PLAYER mode

[INFO] button

- Press to turn on and off the playtime display in the DVD video.
- Press to switch in and out of the LIST mode while playing CD audio.

[SEARCH] button

- Press to open the direct search menu while in the DVD video mode.

[OK] button

- Press to select, play or pause video and audio media.

[■/BAND] button

- Press to stop video and audio media playback.

[0 - 9] buttons

- Press to enter DVD video chapters/titles in the Key Pad screen.
- Press to set the track/folder number of the CD, or MP3/WMA in the Key Pad screen.

[DISC SEL] button

- Press to show/hide the Track List screen in the CD mode.
- Press to show/hide the Folder List screen in the MP3/WMA mode.

[TITLE] button

- Press to go to the title menu on the DVD.

[ROOT] button

- Press to go to the root menu on the DVD.

[▲], [▼], [◀], [▶] buttons

- Press to select button items on the menu screen of a DVD video.
- Press [◀], [▶] to scroll through the page screens in the CD and MP3/WMA modes.

[◀◀], [▶▶] buttons

- Press to select the next higher or lower chapter number in DVD video mode.
- Press to select the next higher or lower track in CD.

[◀◀], [▶▶] buttons

- Press to perform fast-forward and fast-backward. Press again to advance to higher speed reversing or forwarding such as 2x, 4x, 8x and 16x. Press once more to resume normal speed playback.

[RPT] button

- Press to perform chapter repeat in the DVD video mode, and track repeat in CD and MP3/WMA modes.
- Press again to perform title repeat in DVD video mode or folder repeat in MP3/WMA mode. In CD mode, this will activate the repeat all mode.
- Press again to perform all repeat in MP3/WMA playback mode.

[A->B] button

- Press to set initial starting point of repeat. The screen will show 'REP A-'.
- Press again to set repeat ending point. The screen will show 'REP A-B'
- Press again to turn off A-B repeating. The screen will show 'REP AB Off'

[ZOOM] button

- Press to turn on and zoom in while in DVD Video mode. You can zoom in up to 3x.

[AUDIO] button

- Press to switch the AUDIO function in the DVD video mode.

[SUB-T] button

- Press to display subtitles in the DVD video mode.

[ANGLE] button

- Press to switch the ANGLE function in the DVD video mode when the Angle mark is displayed.

iPod mode

[OK] button

- Press to play or pause the selected media.

[◀], [▶] buttons

- Press to scroll the list screens.

[◀◀], [▶▶] buttons

- Press to select the next higher or lower track numbers.

[◀◀], [▶▶] buttons

- Press to perform fast-forward or fast-backward searching. Press again to change the speed to 2x, 4x, 8x or 16x.

4. CAUTIONS ON HANDLING

Operation panel

For a longer service life, be sure to read the following cautions.

- The operation panel will operate properly in a temperature range of 0 to 60°C.
- Do not allow any liquids on the set from drinks, umbrellas etc. Doing so may damage the internal circuitry.
- Do not disassemble or modify the set in any way. Doing so may result in damage.
- Subjecting the operation panel to shocks may result in breakage, deformation or other damage.
- Do not let cigarettes burn the display. Doing so may damage or deform the cabinet.
- If a problem should occur, have the set inspected at your store of purchase.
- Do not insert objects or poke in the space between the operation panel and the main unit when the panel is tilted.
- The remote control unit may not work if the remote control sensor is exposed to direct sunlight.
- In extremely cold weather, the display movement may slow down and the display may darken, but this is not a malfunction. The display will work normally when the temperature increases.
- Small black and shiny spots inside the liquid crystal panel are normal for LCD products.
- The touchkeys on the display operate when slightly touched. Do not press the touchkey screen with much force.
- Do not push the case surrounding the touchkey panel with much force. This may cause malfunctioning of the touchkeys.

Cleaning

- **Cleaning the cabinet**
Use a soft, dry cloth and gently wipe off the dirt. For tough dirt, apply some neutral detergent diluted in water to a soft cloth, wipe off the dirt gently, then wipe again with a dry cloth. Do not use benzene, thinner, car cleaner, etc., as these substances may damage the cabinet or cause the paint to peel. Also, leaving rubber or plastic products in contact with the cabinet for long periods of time may cause stains.
- **Cleaning the liquid crystal panel**
The liquid crystal panel tends to collect dust, so wipe it off occasionally with a soft cloth. The surface is easily scratched, so do not rub it with hard objects.

Handling

- New discs may have some roughness around the edges. If such discs are used, the player may not work or the sound may skip. Use a ball-point pen or the like to remove any roughness from the edge of the disc.

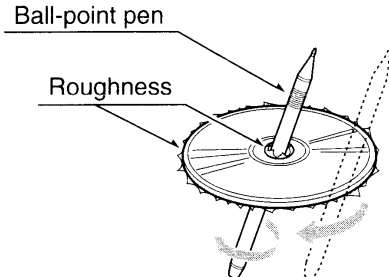

- Never stick labels on the surface of the disc or mark the surface with a pencil or pen.
- Never play a disc with any cellophane tape or other glue on it or with peeling off marks. If you try to play such a disc, you may not be able to get it back out of the DVD player or it may damage the DVD player.
- Do not use discs that have large scratches, are misshapen, cracked, etc. Use of such discs may cause misoperation or damage.
- To remove a disc from its storage case, press down on the center of the case and lift the disc out, holding it carefully by the edges.
- Do not use commercially available disc protection sheets or discs equipped with stabilizers, etc. These may damage the disc or cause breakdown of the internal mechanism.

Storage

- Do not expose discs to direct sunlight or any heat source.
- Do not expose discs to excess humidity or dust.
- Do not expose discs to direct heat from heaters.

Cleaning

- To remove fingermarks and dust, use a soft cloth and wipe in a straight line from the center of the disc to the circumference.
- Do not use any solvents, such as commercially available cleaners, anti-static spray, or thinner to clean discs.
- After using special disc cleaner, let the disc dry off well before playing it.

On Discs

- Exercise a good precaution when loading a disc. The operation panel will close automatically when leaving it open for a while.
- Never turn off the power and remove the unit from the car with a disc loaded.

⚠ CAUTION

For your safety, the driver should not insert or eject a disc opening the operation panel while driving.

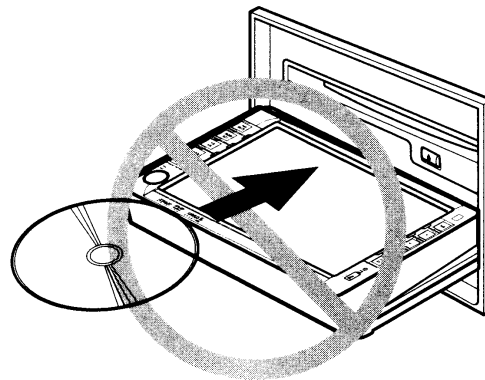

5. DVD VIDEO SYSTEM

DVD video is a high-quality digital video source that provides crisp and clear images. One 12 cm disc contains either one film or four hours of music.

DVD Video Features

This unit provides the following functions in addition to the high image quality and sound quality of DVD video.

Note:

- The functions described in this section, for example, the recorded language, subtitles, angles, etc. differ depending on the DVD video disc. Refer to the instructions provided with the DVD video.
- Some disc functions may operate differently from described in this manual.

Multi-sound function

DVD video can store up to 8 languages for one film; select the language of your preference.

- The languages stored on the disc are indicated by the icon shown below.



Multi-angle function

A DVD video that is filmed from multiple angles allows you to select the angle of choice.

- The number of recorded angles are indicated by the icon shown below.

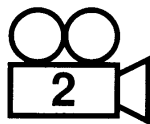

Subpicture (subtitles) function

A DVD video can record subtitles for up to 32 languages and you can select the language of the subtitles you wish to see.

- The number of recorded subtitle languages are indicated by the icon shown below.

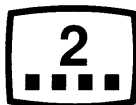

Multi-story function

When a DVD video contains more than one story for a film, you can select the story you wish to enjoy. The operation procedures vary with the disc; observe the instructions for selecting a story provided during playback.

Menu screens



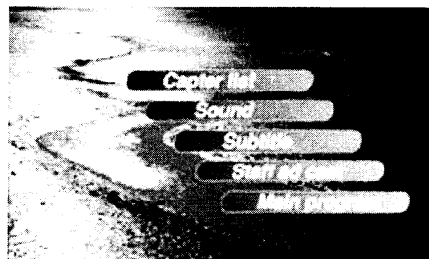

Menus can be called up during DVD video playback to perform menu setting.

- Example showing menu display



Playable discs

This DVD video player can play the following discs.

Playable discs	
DVD video discs 	MP3 ID3 TAG 
Audio CDs 	WMA 

About CD Extra discs

A CD Extra disc is a disc in which a total of two sessions have been recorded. The first session is Audio session and the second session is Data session.

Your personally-created CDs with more than second data sessions recorded cannot be played on this DVD video player.

Note:

- When you play a CD Extra disc, only the first session will be recognized.

About playing a CD-R/CD-RW disc (MP3, WMA)

This player can play CD-R/CD-RW discs previously recorded in music CD format (MP3, WMA) or video CD format.

About playing a DVD-R/RW or DVD+R/RW disc

This player cannot play DVD-R/RW and DVD+R/RW discs previously recorded in video CD format.

However, MP3/WMA files recorded on DVD-R/RW and DVD+R/RW discs can be played.

Discs that cannot be played back

This DVD video player cannot play back DVD-Audio, DVD-RAM, Photo CDs, etc.

Note:

- It may also not be possible to play back CDs recorded on a CD-R unit and CD-RW unit. (Cause: disc characteristics, cracks, dust/dirt, dust/dirt on player's lens, etc.)
- If a CD-R or CD-RW disc that has not been finalized is played, it will take a long time to start playing. Also, it may not be possible to play depending on its recording conditions.
- You cannot play Super Audio CDs. Playback of the CD player is not supported even if it is a hybrid disc.

About MP3/WMA playback

This unit can play back CD-R/CD-RW, DVD-R/RW and DVD+R/RW discs on which MP3/WMA music data have been recorded.

For a detailed information, see the section entitled "Listening to an MP3/WMA" (page 42).

Note on region numbers

The DVD video system assigns a region number to DVD video players and DVD discs by sales area. DVD video players sold in the United States can play back DVD discs with the region number "ALL", "1" or any combination of numbers that also incorporate a "1".

The DVD video region number is marked on the disc jacket as shown below.



About the registered marks etc.

- This product incorporates copyright protection technology that is protected by U.S. patents and other intellectual property rights. Use of this copyright protection technology must be authorized by Macrovision, and is intended for home and other limited viewing uses only unless otherwise authorized by Macrovision. Reverse engineering or disassembly is prohibited.
- Manufactured under license from Dolby Laboratories.
- "Dolby" and the double-D symbol are trademarks of Dolby Laboratories.
- "iPod" is for legal or rightholder-authorized copying only. Do not steal music.
- Windows Media™, and the Windows® logo are trademarks, or registered trademarks of Microsoft Corporation in the United States and/or other countries.

6. OPERATIONS

Basic Operations

Note:

- Be sure to read this chapter referring to the chapter "3. CONTROLS" (page 5).

⚠ CAUTION

When the unit is turned on, starting and stopping the engine with its volume raised to the maximum level may harm your hearings. Be careful about adjusting the volume.

Turning on and off the power

Note:

- Start the engine before using this unit.
- Be careful about using this unit for a long time without running the engine. If you drain the car's battery too far, you may not be able to start the engine and this can reduce the service life of the battery.

1. Start the engine. The power button / knob illumination on the unit will light up.

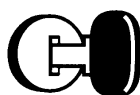

Engine ON position

2. Press the (POWER) button to turn on the power.
 - * Pressing this button while the power is turned on will mute the volume on the MAX385VD, on the VRX485VD, the audio settings appear.
3. To turn off the power, press and hold the [POWER] button for more than 1 second.

Selecting a mode

1. Press the [MENU] button to display the Source menu.
 - * External equipment not connected to this unit is not displayed.
2. Touch the desired mode key.

Adjusting the volume

1. Turn the volume knob to adjust the volume.
 - Clockwise : Increases the volume.
 - Counter- clockwise : Decreases the volume.
 - The volume level indicated in the display is in a range from 0 (min.) to 40 (max.).

⚠ CAUTION

While driving, keep the volume level at which external sounds can be heard.

Mute

1. If using a MAX385VD, press the PWR/MUTE button to turn the mute on and off.
2. If using a VRX485VD, press the [MUTE] button to turn the mute on and off.
 - When the mute is turned on, "⏏" appears on the LCD screen.

Opening the operation panel and adjusting the angle

Open the operation panel when inserting/ejecting a disc.

The angle of the operation panel can be adjusted depending on the mounting angle of the unit or light coming into the car.

⚠ CAUTION

- Do not move the operation panel forcibly or do not apply strong force to the operation panel.
- When the operation panel is operating, be careful not to get your hand or finger caught between the operation panel and main unit or its mechanical parts.
- The driver should not operate the operation panel while driving.

Opening/closing the operation panel

1. Press the [**Δ**] (OPEN/CLOSE) button.
The operation panel will be opened or closed.

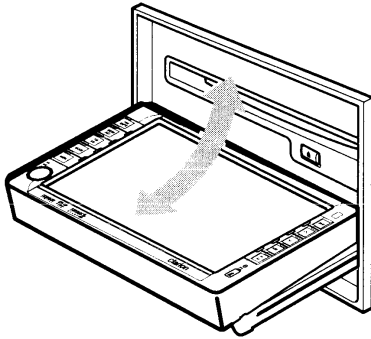

Note:

- The operation panel will close automatically when a disc is inserted. (MAX385VD only)
- When the operation panel is open, the touch panel should not be operated. (MAX385VD only)

Adjusting the angle of the operation panel

The angle of the operation panel can be adjusted in the range of 0° to 30°.

1. Keep pressing the [**Δ**] (OPEN/CLOSE) button more than 2 seconds.
A beep will sound and the operation panel will start moving.

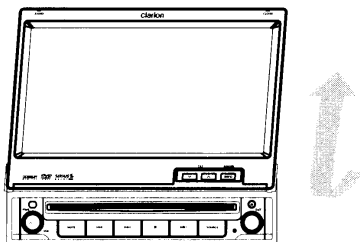
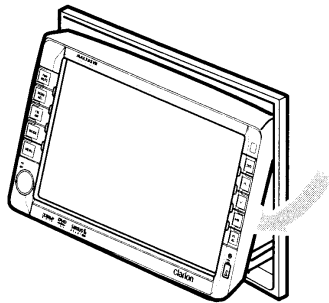

2. When the operation panel is moved to your desired angle, release the button.
The operation panel will stop.
3. For the VRX485VD, simply adjust your desired angle by pressing the [**∨**] or [**∧**] tilt buttons on your control panel.

Returning the operation panel to the original angle (MAX385VD)

1. Press the [**Δ**] (OPEN/CLOSE) button to open the motorized LCD panel.
2. Keep pressing the [**Δ**] (OPEN/CLOSE) button until the panel is back at the normal position.

Adjusting the AUDIO

1. Press the [**EQ**] button on the screen or the [**SEL**] button on the remote control.
2. Touch the item key to adjust.
3. Perform the adjustment.
See the following sections for detail.
4. Touch the [**Back**] key to return to the previous screen.
 - * In the following sections, only the details regarding adjustments are described, procedures to select items are skipped.

Adjusting the balance/fader

1. Touch the BALANCE or FADER in the audio menu.
2. Touch the [**F**] or [**R**] key to adjust to the fader level.
 - The factory default setting is "0".
(Adjustment range: front 9 to rear -9)
3. Touch the [**L**] or [**R**] key to adjust to the balance level.
 - The factory default setting is "0".
(Adjustment range: left -9 to right 9)

Adjusting the BASS

The bass gain and bass frequency can be adjusted as follows.

1. Enter the Audio settings menu.
 2. Touch the [**-**] or [**+**] key to set the desirable level.
- GAIN:**
-7 to 7 (The factory default setting is "0")
3. To set the bass center frequency, enter the ASP adjustment in the SETTING menu.

Adjusting the TREBLE

The treble gain and treble frequency can be adjusted as follows.

1. Enter the Audio settings menu.
 2. Touch the [**-**] or [**+**] key to set the desirable level.
- GAIN:**
-7 to 7 (The factory default setting is "0".)
3. To set the treble center frequency, enter the ASP adjustment in the SETTING menu.

Basic Operations

Adjusting the non fader output phase

You can adjust the subwoofer phase from the SETTING adjustment menu.

1. Touch the ASP tab in the SETTING menu.
2. Touch the [SUB PHASE] button in the ASP menu and a selection menu will appear.

Setting range:

0 or 180 (The factory default setting is "0")

Adjusting the non fader output Low Pass Crossover

You can adjust the subwoofer phase from the SETTING adjustment menu.

1. Touch the ASP tab in the SETTING menu.
2. Touch the [SUB FILTER] button in the ASP menu and a selection menu will appear.

Setting range:

80,120 or 160Hz (The default setting is "60")

Adjusting the non fader output volume

You can adjust the volume output from the unit's Audio adjustment menu.

1. Touch the [-] or [+] key of the SW VOL item to adjust to desirable level.

Setting range:

-7 to 7 (The factory default setting is "0".)

Turning on/off the LOUDNESS

The Loudness setting emphasizes the low and high sound level areas to provide a more full and dynamic sound without distortion.

1. Enter the Audio settings menu.
2. Touch [ON] or [OFF] of the [LOUDNESS] item to turn on or off the loudness effect. (The factory default setting is "OFF").

Adjusting the MONITOR

1. Press the [PIC] button on the remote control or [MONI/ADJ] button on the MAX385VD.
2. Perform the adjustment for the desired item. See the following sections for detail.
3. Touch the [Back] key to return to the previous screen.

* In the following sections, only the details regarding adjustments are described, procedures to select items are skipped.

Adjusting the brightness, contrast and color levels

1. Touch the [PIC] key on the remote control or [MONI/ADJ] key on the MAX385VD.
2. Touch the [-] or [+] key to make adjustments to the settings to your desired levels.

"Bright":

Adjusts the brightness of the display.

"Color":

Adjusts the color saturation.

"Contrast":

Adjusts the level of black. or green is emphasized).

Bright/Color/Contrast:

The factory default setting is medium level.

Adjusting the SETTING

1. Press the [MENU] button, then touch the [SETTING] key.
2. Touch the top navigation tabs to switch between the SETTING menus. You can navigate between General, Screen, ASP, Regional, and Rating.
3. Perform the adjustment for the desired item. See the following sections for detail.
4. Touch the [Back] key to return to the previous screen.
 - * In the following sections, only the details regarding adjustments are described, procedures to select items are skipped.

Adjusting the CLOCK

1. Press the [**SETTING**] button, then touch the [**CLOCK**] key.
2. The entry keypad will appear. Enter your time without spaces. For example, 12:45 would be entered as '1245'. Press [**OK**] to accept or [**←**] to backspace and correct your entry. If you have selected to display your time in 24 hour format, you must enter your time in 24 hour format such as '1745' for 5:45PM.
3. To change your time from AM to PM, press AM or PM text in the CLOCK selection box. If you have selected to display your time in 24 hour format, you will not have this selection.

Adjusting the RADIO region

1. Press the [**SETTING**] button, then touch the [**RADIO**] key.
2. A region selection menu will appear. Scroll down using the arrow at the bottom of the menu. Scroll up using the arrow at the top of the menu. Once you have located the region that matches your area's radio spacing and frequency range, touch the region to make your selection. If the region selected is incorrect, radio reception will be poor.

Reset to Factory Defaults

1. Press the [**SETTING**] button, then touch the [**LOAD FACTORY**] key.
2. A selection menu will appear. Select [**YES**] to restore your unit to factory default settings. This function will erase all memory from the unit and you must reset all personalized items such as tuner presets.
NOTE: You will be asked once to confirm that you would like to reset the unit. The unit will power down and restart with factory defaults.

Radio Operations

Listening to the radio

1. Press the **[MENU]** button, and touch the **[TUNER]** key.
The TUNER mode screen is displayed.



2. Press the **[BAND]** button or touch the **[Band]** key to select the radio band. Each time the button is pressed, the radio reception band changes in the following order:
FM1 → FM2 → FM3 → AM → FM1...

Seek tuning

1. Press the **[BAND]** button or touch the **[Band]** key to select the desired band (FM or AM).
2. Touch the **[◀◀]** or **[▶▶]** key to automatically seek a station.
 - When touching the **[▶▶]** key, the station is sought in the direction of higher frequencies.
 - When touching the **[◀◀]** key, the station is sought in the direction of lower frequencies.

Selecting presets by direct access

This function displays the Key Pad on the screen allowing you to tune by entering a preset number.

1. Press the **[BAND]** button or touch the **[Band]** key to select the desired band (FM or AM).
2. Touch the **[DIRECT]** key to display the Key Pad screen.
3. Touch the **[0]** to **[9]** key corresponding with the preset you desired. When you input the wrong number, touch the **[←]** key to delete the last input number.
4. Touch the **[ENT]** key to tune in to the entered preset.

Manual tuning

1. Press the **[BAND]** button or touch the **[Band]** key to select the desired band (FM or AM).
2. Touch the **[◀◀]** or **[▶▶]** key to manually select a station.
 - When touching the **[▶▶]** key, the frequency is tuned in the direction of higher frequencies.
 - When touching the **[◀◀]** key, the frequency is tuned in the direction of lower frequencies.

Recalling a preset station

There are total of 48 preset positions (12-FM1, 12-FM2, 12-FM3, 12-AM) to store individual radio stations in memory.

There are 2 ways available to recall the preset station.

● Using the remote controller

1. Press the **[BAND]** button to select the desired band (FM or AM).
2. Press the preset number desired on the 0-9 numeric keypad.

● Using the Preset List screen

1. Touch the **[List]** key.

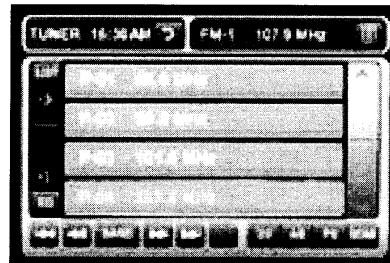

2. Touch the corresponding Preset key to recall the stored station.
 - * You can select the desired band by touching the **[Band]** key. Scroll through pages using scroll bar buttons to the right of the presets.
 - * Touching and holding the desired Preset key for more than 2 seconds will store the current station to the preset memory.
3. Touch the **[List]** key to return to the previous screen.

Manual memory

1. Touch the **[Band]** key to select the desired band. (FM or AM)
2. Select the desired station with the seek tuning, manual tuning, or preset tuning.
3. Touch the **[List]** key.
4. Touch and hold one of the Preset key for more than 2 seconds to store the current station into the preset memory.
5. Scroll through the 3 pages of presets in each band by pressing the scroll bar buttons to the right of the presets.

Auto store

The Auto Store is a function for storing up to 12 stations that are automatically tuned in sequentially. If 12 receivable stations cannot be received, a previously stored station remains unoverwritten at the memory position.

1. Touch the [**Band**] key to select the desired band. (FM or AM)
2. Touch the [**AS**] key momentarily to start the Auto Store function.
A beep sounds and the stations with good reception are stored automatically to the preset channels.

Preset scan

The Preset Scan receives the stations stored in the preset memory in order. This function is useful when searching for the desired station in memory.

1. Touch the [**Band**] key to select the desired band. (FM or AM)
2. Touch the [**PS**] key to start the Preset Scan. The unit starts scanning each station for 10 seconds sequentially.
3. When the desired station is tuned in, touch the [**PS**] key again to continue receiving that station.

Channel scan

The Channel Scan receives the stations sequentially and scans continuously. This function is useful when searching for the desired station in an unfamiliar area.

1. Touch the [**Band**] key to select the desired band. (FM or AM)
2. Touch the [**SCAN**] key to start the Channel Scan. The unit starts scanning each station for 10 seconds sequentially.
3. When the desired station is tuned in, touch the [**SCAN**] key again to continue receiving that station.

DX / LOC setting

The DX / LOC setting changes the tuner sensitivity in order to separate closely spaced stations. This feature is useful in areas that have many radio stations in close proximity.

1. Touch the [**DX**] key to switch to LOCAL tuner sensitivity.
2. Touch the [**LOC**] key to switch to DX tuner sensitivity.

DVD Video Player Operations

Changing DVD System Settings

Note:

- If the Setup operation is performed in the middle of DVD video play, the disc will restart from beginning.

Selecting the DVD SETUP menu

1. Press the [**MENU**] button, and touch the [**SETTING**] key.
The main SETTING screen is displayed.
2. Touch the [**Screen**] key to display the Display settings menu.
3. Touch the [**Regional**] key to display the Language settings menu.
3. Touch the [**Rating**] key to display the Parental Controls settings menu.
4. Perform setting for the desired setting items. See the following sections for detail.
5. Touch the [**Back**] key.

- * In the following sections, only the details regarding settings are described, the procedures to select items are skipped.

Screen Saver Feature

1. Press the [**MENU**] button, and touch the [**SETTING**] key.
The main SETTING screen is displayed.
2. Touch the [**Screen**] key to display the Display settings menu.
3. Touch the [**Screen Saver**] key to display the screen saver selection menu.
4. Touch the [**OFF**] or [**ON**] key to turn off or on the screen saver feature

Note:

- If the screen saver is not for entertainment purposes. The feature is intended to prevent screen damage if the unit is paused or stopped for an extended period of time.

Setting up the screen size

1. Touch the [Aspect Ratio] button to enter the TV DISPLAY item to change the screen size to "16:9" or "4:3".
 - The factory default setting is "4:3".
- **When watching a wide type through a conventional type of the rear view monitor (4:3)**
4:3 :
 The leftmost and rightmost areas of the screen are cut off.

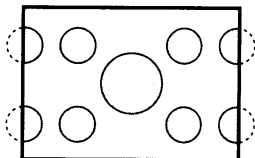

This function allows displaying the important part of image fully on the screen. In some cases, image is displayed while being panned (scrolled).

- **When watching a wide type through a wide type of the rear view monitor (16:9)**
16:9 :
 The leftmost and rightmost areas of the screen are cut off.

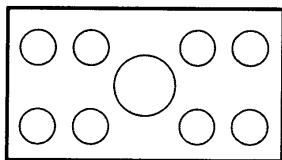

Setting up the audio language

- 4-1. Touch the [REGIONAL] key in the SETTING menu.
The Language menu is displayed.
- 4-2. Touch the [Audio] key to select a desired language and set it by touching the available languages.
 - The factory default setting is "ENGLISH".

Setting up the subtitle language

- 4-1. Touch the [REGIONAL] key in the SETTING menu.
The Language menu is displayed.
- 4-2. Touch the [Subtitle] key to select a desired language and set it by touching the available languages.
 - The factory default setting is "ENGLISH".

Setting up the password for setting up of the parental level

- The factory default setting is "0000".
- 4-1. Touch the [RATING] key in the SETTING menu.
 - 4-2. Touch the [Set Password] key and a key pad will appear.
 - Input the old password, and touch the [OK] key.
 - * Input "4356" to return password to "0000".
 - Input a new password, and touch the [ENT] key.

Note:

- When a disc with view restrictions is inserted, you will be prompted to input a password. The disc will not be viewable until the correct password is entered.

Setting up the parental level

You can change the level of parental lock (audio-visual restriction).

This function allows cutting scenes that are unfavorable for children or replacing them automatically with other scenes prepared in advance. For example, by replacing scenes of radical violence or portrayals of sex with safe scenes, you can make a trouble-free story as if it were so from the beginning.

- 4-1. Touch the [RATING] key in the SETTINGS menu.
- 4-1. Touch the [PARENTAL CONTROL] key in the RATING menu.
- 4-2. Touch the ten-key (0 to 9) to input a 4-digit password, and touch the [ENT] key.
 - The factory default setting of the password is "0000".
- 4-3. Touch the appropriate parental rating that is desired. 1 is similar to G and 8 is similar to NR.
 - The factory default setting is "8".

DVD Video Player Operations

The relationship between DVD video category codes and parental level are shown in the table below. Use this table when setting the parental level.

LEVEL7	NC-17 (NO ONE 17 AND UNDER ADMITTED)
LEVEL6	R (RESTRICTED)
LEVEL4	PG-13 (PARENTS STRONGLY CAUTIONED)
LEVEL3	PG (PARENTAL GUIDANCE SUGGESTED)
LEVEL1	G (GENERAL AUDIENCES)

- The contents that the parental level restricts vary with the country code.

Basic Operations

Loading a disc

1. Press the [**⏏**] (OPEN/CLOSE) button to open the operation panel. (MAX385VD only)
2. Insert a disc into the center of the insertion slot with the label side facing up. The disc plays automatically after loading.

Note:

- Never insert foreign objects into the disc insertion slot.
- If the disc is not inserted easily, there may be another disc in the mechanism or the unit may require service.
- 8 cm (single play) discs cannot be used.

⚠ CAUTION

For your safety, the driver should not insert or eject a disc opening the operation panel while driving.

Watching/Listening to a disc already inserted

1. Press the [**MENU**] button, and touch the [**DVD/CD**] key to select the DVD PLAYER mode.
Play starts automatically.
If no disc is loaded in the unit, the DVD/CD icon will be shaded in the display.

⚠ WARNING

- Some videos may be recorded at higher than desired volume levels. Increase the volume gradually from the minimal setting after the video has started.
- For your safety, the driver should not watch the video or operate the controls while driving. Please note that watching and operating the video while driving are prohibited by law in some countries.

Note:

- For your safety, your entertainment system has a safety function which turns off the picture when the car is moving, so only the audio can be heard. The picture can only be watched when the car is stopped and the parking brake is applied.
- If "**AUDIO ONLY**" appears on the screen just after turning on the ACC power of the car, release the parking brake while confirming safety, and then engage the parking brake again.

Pausing play

1. Press the [**OK**] button or touch the [**▶/||**] key to pause play.
"PAUSE" appears in the display.
2. To resume disc play, press the [**▶/||**] button again.

Ejecting a disc

1. Press the [**⏏**] (OPEN/CLOSE) button to open the operation panel. (MAX385VD only)
2. Press the [**▲**] (EJECT) button to eject disc.
"EJECT" appears in the display. The play mode then switches to the TUNER mode.
 - * If a disc is left in the ejected position for 15 seconds, the disc is automatically reloaded (Auto reload). In this case, however, the play mode will remain set to the TUNER mode.

Note:

- If you force a disc into before auto reloading, this can damage the disc.

DVD Video Player Operations

Watching a DVD-Video

After disc loading, the play mode is automatically engaged.

- When playback is not started, press the [OK] button or touch the [▶/||] key.
- Button operation may differ depending on the story of the disc.

● After the menu screen is displayed

For normal DVD-Video discs, the DVD menu screen appears.

After the DVD menu screen is displayed, select an item in the following operations and play it back.

Showing the DVD PLAYER mode screen

The DVD PLAYER mode screen is used to control the playback mode from the screen.

1. Touch the screen.
The DVD PLAYER mode screen is displayed. If you do not touch the screen for 5 seconds, the display will return to the playback screen.



Showing the DVD menu

1. Showing the DVD PLAYER mode screen, touch the [Menu] key during playback. The DVD menu appears.
The displayed contents may differ depending * on the DVD software.
- Example showing DVD menu display



Operating the DVD menu

You can select the button items displayed in the DVD menu by directly touching it. If the button items are hard to select correctly, you can also operate them by using the remote control directional buttons.

On the MAX385VD, you can press the volume knob momentarily, then turn it to change the selected items on the screen. Press the [▶/||] button to select it.

On the VRX485VD, you can use the right knob to change the selected items on the screen. Press the right knob or [▶/||] button to select it.

Stopping playback

1. Showing the DVD PLAYER mode screen, touch the [■] key. Playback is stopped.
On the VRX485VD, you can also press the [■] key on the front control panel.
2. To resume playback, press the [▶/||] button. Playback resumes from the scene where playback is stopped.

Pausing playback

1. Press the [OK] button or touch the [▶/||] key during playback. Playback pauses.
2. To resume playback, press the [▶/||] button again. Playback resumes.

Skipping a chapter (searching)

● About chapter

Chapter means a small segment to divide the data area of the disc.

- 1-1. Press the [▲] or [▼] button during playback. (MAX385VD)
- 1-2. Press the [◀◀] or [▶▶] button during playback. (VRX485VD)

Chapters are skipped, as many as the times the button is pressed, and playback starts.

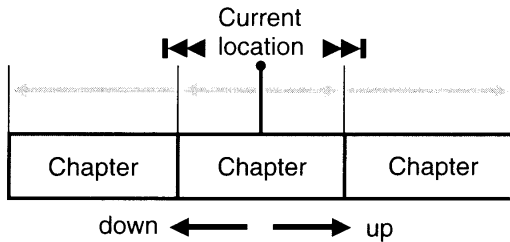

- Pressing the [▶▶] or [▼] button starts playback from the beginning of the next chapter.
- Pressing the [◀◀] or [▲] button starts playback from the beginning of the current chapter. When this button is pressed again within about 3 seconds, playback starts from the beginning of the previous chapter.

Fast forward and fast backward

1. Press the [◀◀] or [▶▶] button to start your fast backward or fast forward during playback. The playback speed starts at 2x, then will increase to 4x, 8x, and 16x with each additional press.
 - * No audio is reproduced during fast forward and fast backward operation.
 - * The fast forward and fast backward speed may differ depending on the disc.

Searching with a chapter/title number

You can locate the beginning of a scene using the chapter numbers or title numbers recorded on the DVD-Video disc.

1. Showing the DVD PLAYER mode screen, touch the [CHAP] key. The Key Pad screen appears with the chapter number input mode. Touching the [Title] key turns the Key Pad to the title number input mode. Touching the [Time] key turns the Key Pad to the time number input mode.

- **Title**
A large segment to divide the data area of the disc.
 - **Chapter**
A small segment to divide the data area of the disc.
 - **Time**
A specific time on the disc.
2. Input the number of the title/chapter/time that you want to play back with the [0] to [9] key.
 3. Touch the [ENT] key. Playback starts from the scene of the input title number, time or chapter number.
 - * If the input title/chapter/time number does not exist or searching with a title/chapter number is not allowed, the screen image will not change.
 4. Touch the [Back] key.

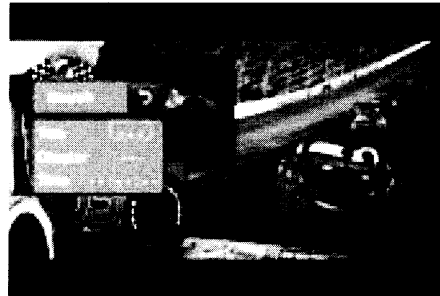

Repeat playback

This operation plays back chapters recorded on the DVD-Video repeatedly.

1. Showing the DVD PLAYER mode screen, touch the [Repeat] key.
2. Touch the [Repeat] key once for Chapter Repeat, again for Title Repeat.
3. Press the [Repeat] button again to turn off the repeat playback.

Using the title menu

On DVD discs containing two or more titles, you can select from the title menu for playback.

1. Showing the DVD PLAYER mode screen, touch the [Top Menu] key during playback. The title menu screen appears.
 - * Depending on the disc, the title menu cannot be called.
2. Select the button items displayed in the title menu screen by the same way of the DVD menu operation.
 - * Depending on the disc, items cannot be selected with the ten-key buttons.

Switching among languages

On discs in which two or more audios or audio languages have been recorded, you can switch among the audio languages during playback.

1. Touch the [**Audio**] key during playback.
 - Each time you touch the key, you can switch among audio languages.
 - It may take time to switch among audios.
 - * Depending on the disc, up to 8 audios may be recorded. For details, see the mark of the disc (8): Indicates that 8 audios have been recorded).
 - * When the power is turned on and when the disc is changed to a new one, the language set as the factory default is selected. If that language has not been recorded, the language specified on the disc.
 - * Depending on the disc, switching may be completely impossible or impossible on some scenes.
2. The DVD PLAYER mode screen will hide in 5 seconds after your selection is made.

Switching subtitles

On DVD discs in which two or more subtitle languages have been recorded, you can switch among the subtitle languages during playback.

1. Touch the [**Sub T.**] key during playback. Each time you touch the key, you can switch among subtitles.
 - It may take time to switch among subtitles.
 - * Depending on the disc, up to 32 kinds of subtitles may be recorded. For details, see the mark of the disc (8): Indicates that 8 kinds of subtitles have been recorded).
 - * Depending on the disc, switching may be completely impossible or impossible on some scenes.
2. The DVD PLAYER mode screen will hide in 5 seconds after your selection is made.

● To turn off subtitles

1. Repeat touching the [**Sub T.**] key until "**Sub Title: OFF**" is displayed on the screen. Subtitles are turned off.

Switching angles

On DVD discs in which video images have been recorded in two or more angles, you can switch among the angles during playback.

1. Touch the [**Angle**] button on the remote controller during playback. Each time you touch the key, you can switch among angles.
 - It may take time to switch among angles.
 - * Depending on the disc, up to 9 angles may be recorded. For details, see the mark of the disc (9): Indicates multi-angle).
 - * Depending on the disc, angles may switch smoothly or switch with a momentary still image.
 - * Depending on the disc, switching may be completely impossible or impossible on some scenes.
 - * Depending on the disc, scenes recorded in two or more angles may be played back.

Displaying the playback status

1. Showing the DVD PLAYER mode screen, touch the [**INFO**] key.
2. or Touch the [**INFO**] button on the remote.
3. Touch the screen to hide the playback status screen.
Playback status is displayed on the screen until it is manually hidden.

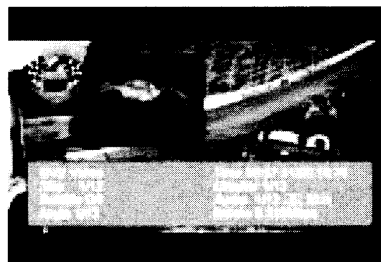

Listening to a CD

Pausing playback

1. Press the [OK] button or touch the [▶/II] key during playback.
Playback pauses.
2. To resume playback, press the [OK] button or touch the [▶/II] key.
Playback resumes.

Skipping a track (searching)

1. Press the [I◀◀] or [▶▶I] button during playback.
Tracks are skipped, as many as the times the button is pressed, and playback starts.
 - Pressing the [▶▶I] button starts playback from the beginning of the next track.
 - Pressing the [I◀◀] button starts playback from the beginning of the current track.
When this button is pressed again within about 2 seconds, playback starts from the beginning of the previous track.

Fast forward and fast backward

1. Press the [◀◀] or [▶▶] button during playback.
Press again to advance to higherspeed reversing or forwarding such as 2x, 4x, 8x and 16x. Press once more to resume normal speed playback.

Searching with a track number

This operation allows searching using the track numbers recorded on the CDs.

1. Touch the [Direct] key.
2. Input the track number that you want to play back with [0] to [9] key.
3. Touch the [OK] key.
Playback starts from the track of the input track number.
 - If the input track number does not exist or searching with a track number is not allowed, the screen image will not change.

Selecting a track on the Track List screen

This function allows you to select tracks from a displayed list.

1. Touch the [List] key.
The Track List screen is displayed.
2. When the desired track is not displayed, touch the [▲] or [▼] key to scroll the track list.
3. Touch the desired track title key.
The corresponding track is started playback.
4. Press the [LIST] key to return to the previous screen.

Other various play functions

1. Touch the touch key of the function you want to play.
 - [Repeat]: Press once to start a single track repeat. Press again to activate a repeat all. To turn off, press until 'Repeat Off' is shown on the display.
 - Repeat symbols are displayed in the info window in the upper right area of the screen.
 - [Track Random]: track random playback
This operation plays back all tracks on the disc in no particular order. Press again to turn off the feature.
 - A random symbol is displayed in the info window in the upper right area of the screen.

Listening to an MP3/WMA

This unit is an ID3 Tag compatible model.

This unit supports the ID3 TAGs of the Version 2.4, 2.3, 1.1 and 1.0.

In displaying, this unit gives priority to the Version 2.3 and 2.4 TAGs.

After disc loading, the play mode is automatically engaged.

What is MP3/WMA?

MP3 is an audio compression method and classified into audio layer 3 of MPEG standards. WMA is an audio compression method developed by Microsoft Corporation.

These audio compression methods have penetrated into PC users and become a standard format.

These features compress the original audio data to about 10 percent of its initial size with a high sound quality. This means that about 10 music CDs can be recorded on a CD-R disc or CD-RW disc to allow a long listening time without having to change CDs.

Note:

- Some CDs recorded on CD-R/RW mode may not be usable.

Displaying MP3/WMA TAG titles

Tag information such as title, artist and album title can be displayed for an MP3/WMA file containing Tag information.

Precautions when creating an MP3 disc

● File extensions

1. Always add a file extension ".MP3" or ".mp3" to an MP3 file, and ".WMA" or ".wma" to a WMA file by using single byte letters. If you add a file extension other than specified or forget to add these file extension, the file cannot be played. In addition, if you use upper case and lower case letters (capital and small letters) mixedly for file extensions, normal play may not be possible.
2. Files other than MP3/WMA data cannot be played.
Playing files with a format not supported will be skipped, and the scan, random and repeat playback mode may be canceled.

● Logical format (File system)

1. When writing an MP3/WMA file on a disc, please select "ISO9660 level 1 or level 2 (without including expansion format)" as the writing software format. Normal playback may not be possible if the disc is recorded on another format.
2. The folder name and file name can be displayed as the title during MP3/WMA play but the title must be within 31 single byte alphabetical letters and numerals for the folder name and file name (including an extension). Entering more letters or numerals than specified may cause an incorrect display.

● Folder structure

1. A disc with a folder having more than 8 hierarchical levels will conflict with the ISO9660 and playback will be impossible.

● Number of files or folders

1. The maximum allowable number of folders is 255 (including root directory); the maximum allowable number of files is 512 (max. 255 per folder). This represents the maximum number of tracks that can be played back.
2. Tracks are played in the order that they were recorded onto a disc. (Tracks might not always be played in the order displayed on the PC.)
 - Some noise may occur depending on the type of encoder software used while recording.
 - In case of a track recorded at VBR (variable bit rate), the display for the play time of the track may be slightly different from the actual play time. Also, the recommended value of VBR ranges from 32 kbps to 320 kbps.
 - After disc selection, the play mode is automatically engaged.

Note:

- If Tag information was entered with 2-byte characters, it may occur that the characters are not reproduced properly on the display.
- MP3/WMA files that the DRM (Digital Rights Management) function is set cannot be played.

DVD Video Player Operations

Regarding MP3/WMA folder creation

Up to 8 folder levels (including the root directory) can be created for MP3/WMA files (items 1 – in the illustration). However, on this unit, folders created above the third level will be converted to 2 levels.

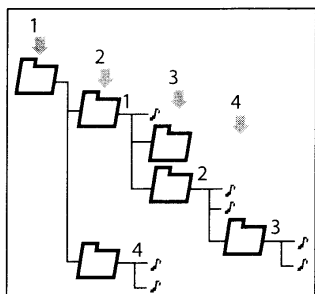

Pausing playback

1. Press the [**OK**] button or touch the [▶/⏸] key during playback.
Playback pauses.
2. To resume playback, press the [**OK**] button or touch the [▶/⏸] key again.
Playback resumes.

Skipping a track (searching)

1. Press the [⏮] or [⏭] button during playback.
Tracks are skipped, as many as the times the button is pressed, and playback starts.
 - Press the [⏭] button starts playback from the beginning of the next track.
 - Press the [⏮] button starts playback from the beginning of the current track. When this button is pressed again within about 2 seconds, playback starts from the beginning of the previous track.
- * This function performs in the current folder only.

Fast forward and fast backward

1. Press the [⏮] or [⏭] button during playback to start the fast backward or fast forward. A second press will increase speed to 4x, then 8x, and 16x. Press [▶/⏸] for normal playback speed.

Selecting a folder/track on the LIST screen

1. Touch the [**List**] key during playback.
Folder List screen is displayed.
2. When the desired folder is not displayed, touch the [⬆] or [⬇] key to scroll the list.
3. Touch the desired folder name key.
The Track List screen appears.
4. Touch the [⬆] or [⬇] key to scroll the list, and touch the desired track name key.
The corresponding track is started playback.
5. Touch the [**LIST**] key.

Other various play functions

1. Touch the touch key of the function you want to play.
 - [**Repeat**]: track random playback
 - Repeat Single**: track repeat playback
This operation plays back the tracks currently being played back repeatedly.
 - An icon is displayed in the info window in the upper right corner of the display.
 - Repeat Folder**: folder repeat playback
This operation plays back tracks in an MP3/WMA folder repeatedly.
 - An icon is displayed in the info window in the upper right corner of the display.
 - Repeat All**: repeat all playback
This operation plays back tracks in an MP3/WMA disc repeatedly.
 - An icon is displayed in the info window in the upper right corner of the display.
 - [**Random**]: folder random playback
This operation plays back tracks recorded on the disc in no particular order.
 - An icon is displayed in the info window in the upper right corner of the display.

iPod Operations

This unit can be used to control a connected Apple iPod (iPod Mini, fourth generation, iPod nano, iPod with video).

Note:

- Note that iPod versions higher than those noted above may not be playable or offer all features.
- The unit will not operate, or may operate improperly with unsupported versions.
- First, second and third generation iPod and iPod shuffle cannot be used.

Notes regarding use of Apple iPod

- When using an iPod, after connecting the iPod to the connector, select the iPod mode by touching the [iPod] key on the Source menu.
- After the iPod has been connected to this unit, the iPod's buttons are disabled for operation.
- When the iPod mode has been selected, a special iPod control screen is displayed different from the main screens for other modes.
- This unit can display the Podcast titles*, Artist names, Album titles, Song titles, Genre names, Composer names and Audio Book titles* registered on the iPod. When no data is present, the title display will remain blank.
 - * Whether these functions are available or not depends on the iPod version.
- The iPod is used with the equalizer function turned OFF.
- Do NOT connect an iPod to the unit with a headset connected to the iPod.

● Precautions regarding battery consumption:

When the iPod's internal battery becomes depleted, the recharge warning indicator will appear in the iPod's display. In this condition, the iPod cannot be played even if attached to the unit. Also, the unit's recharging function cannot be used to recharge the iPod.

As a result, when the iPod's battery becomes depleted, use the dedicated charger provided with it to recharge the battery.

Controlling the iPod

● Selecting the iPod mode

1. Connect the iPod to the connector.
2. Press the [iPod] key on the Source menu.

● iPod menu screen operation keys

[VIDEO] key

- Switches to the screen of which the video output from the iPod is displayed.

Note:

- Note that not all iPod devices are compatible to output video to this unit.

[FOLDER] List key

- Displays the corresponding list screen. [Composers], [Artists], [Albums], [Songs] and [Genres] are available from the iPod folder list menu screen.

[Shuffle] key

- Use to switch the shuffle mode on or off. When enabled, this function performs playback of tracks in random order, regardless of the order in which they are recorded.

[▶/||] key

- Use to control playback and pause.

● Operation display

Pausing playback

1. Press the [OK] button or touch the [▶/||] key during playback. Playback pauses.
2. To resume playback, press the [OK] button or touch the [▶/||] key again. Playback resumes.

Skipping a track (searching)

1. Press the [◀◀] or [▶▶] button during playback. Tracks are skipped, as many as the times the button is pressed, and playback starts.
 - Pressing the [▶▶] button starts playback from the beginning of the next track.
 - Pressing the [◀◀] button starts playback from the beginning of the current track. When this button is pressed again within about 2 seconds, playback starts from the beginning of the previous track.

Fast forward and fast backward

1. Press the [◀◀] or [▶▶] button during playback.
The first press will advance the music at 2x speed. Following presses will increase the speed to 4x, 8x, and 16x.
Press the [▶/||] button to resume normal speed playback.

Selecting a list item from a list screen

1. Touch the Folder List icon in the iPod selection screen.
2. Touch a desired list item on the screen to display the corresponding list of tracks.
 - Use the [▲] and [▼] keys to scroll the list.
 - * Skip this operation for the Songs list.
3. Touch the desired track name on the list to play back.
 - Use the [▲] and [▼] keys to scroll the list.

Viewing video data in the iPod (only for the iPod with video features)

When you connect an iPod with video features by using the optional connector cable for iPod with video, you can enjoy the video data and slideshow data stored in the iPod showing them on the display of this unit (and the rear monitor if connected).

Note:

- Do not connect the iPod to this unit when a Video Playlists item is selected on the iPod.

1. Touch the [VIDEO] key on the iPod menu screen. The screen will be changed to a "waiting for iPod video" screen.
In this condition, the iPod cannot be controlled from this unit. The iPod is turned into the normal operation mode, and you can control the iPod using the original controls of the iPod (iPod operation mode).
2. Play back your desired video data or slideshow data from the iPod.
The specified image data will be displayed on the display.
3. To return to the iPod menu screen, stop your video content and press the [VIDEO] key.
 - * When you touch the [Music] key during playing back image data, the playback is terminated and the first track of the first playlist will be played back.

Note:

- "AUDIO ONLY" is displayed when the automobile is moving.
- Image data may not be played back according to the status of the iPod.

AUX IN Operations

This function is available when a VTR, etc. is connected to the visual terminal.

⚠ WARNING

For your safety, the driver should not watch the VTR, etc. or operate the controls while driving. Please note that watching and operating the VTR, etc. while driving are prohibited by law in some countries.

Switching to the AUX IN mode

Note:

- For your safety, the unit has a safety function which turns off the picture when the car is moving, so only the audio can be heard. The picture can only be watched when the car is stopped and the parking brake is applied.

Press the [MENU] button, and touch the [AV IN] key.

Sirius Satellite Radio Operations

This function is available when a Sirius Satellite Radio Receiver is connected through the . dedicated connection. This unit requires the following receiver:

- SIRIUS Satellite Radio Receiver: SC-C1

Note:

SIRIUS satellite radio is a subscription service. Please contact Sirius Radio to begin or alter your subscription:

- Internet: www.sirius.com
- Telephone: 888-539-SIRIUS (747487)

Selecting a Satellite Radio mode

1. Press the [MODE] or [SOURCE] button until SIRIUS is displayed or select 'SIRIUS' in the main menu. You can reach the main menu by pressing the [MENU] button on your unit. The system changes to the Sirius Satellite Radio mode.

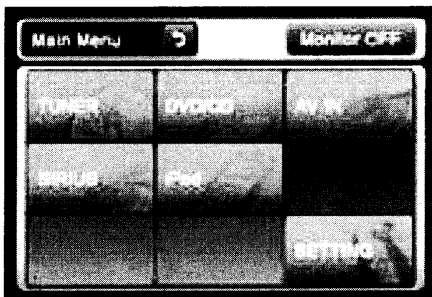

Selecting your presets

1. Press the [BAND] button or touch the [Band] key to enter the preset memory menu. You can save up to 20 presets for your favorite channels for quick access.

Information displayed during reception

The following information is displayed when the satellite radio cannot be received normally.

- When the receiver is turned on the first time or after a reset: "UPDATING" followed by a percentage of completion.
- When a channel is being tuned in (no signal is yet received): "ACQUIRING SIGNAL"
- A channel without a broadcast has been selected: "INVALID CHANNEL"
- A channel not covered by your contract: "CALL 888-539-SIRIUS"
Call (888)539-747487 to activate your radio
- When a channel is out of air time: "OFF AIR"
- When the antenna is disconnected or has been damaged: "ANTENNA ERROR"

Confirming your Radio ID

● SIRIUS

1. Touch the [Search] key to display the Key Pad screen.
2. Touch the [0] key, then touch the [ENT] key. Your Radio ID (12-digits number) will be displayed.
3. To return to the Sirius Radio, enter a new channel to resume.

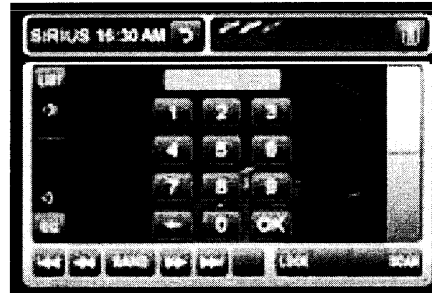

Displaying channel labels

1. Touch the [LIST] button and the next four channels are displayed for your ease of viewing.
2. Touch the [LIST] button again to return to the main display screen.

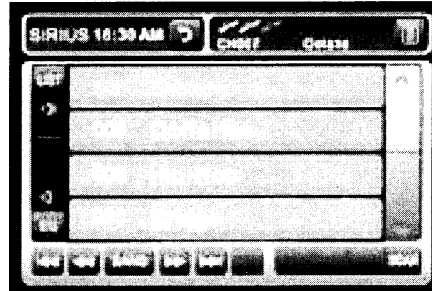

Channel selection

Channels are selected with the [◀◀] or [▶▶] buttons.

- * For details, see the following operation descriptions.

Note:

- The audio output is muted and other button operations are not accepted during channel selection.

Selecting a station with the channel number

1. Touch the direct access button on the Sirius screen to enter direct channel selection. The button is at the top right corner.
2. Enter the channel number of your desired station by touching the [0] to [9] keys. If you enter a wrong number, you can cancel it by touching the [BACK] key.
3. Touch the [OK] key.
The radio channel you entered will be tuned.

Selecting a station with in the tuning mode

● Seek tuning

Only channels that can be received are selected. Channels that are locked and channels not covered by the contract will be skipped.

1. Touch the [◀◀] or [▶▶] key.
The receiver seeks the next available channel below or above the current channel.

Saving a preset station

A total of 20 satellite radio stations can be stored in the receiver's memory. You can access the presets by pressing the BAND button This allows you to store your favorite satellite radio stations the memory for later recall.

1. Touch the [BAND] button to enter the preset list to select or save your presets.
2. Touch and hold for more than 2 seconds the corresponding preset key to save the selected channel.

* There are 5 pages of preset memory space available for your use. You can scroll the pages using the scroll bar buttons to the right of the screen.
3. Touch the [BAND] key to return to the previous screen.

Auto preset store

1. Touch the [BAND] button and hold it for 3 seconds and the selected channel will be stored in the next available empty preset location.

Recalling a preset station

A total of 20 satellite radio stations can be recalled from the receiver's memory. You can access the presets by pressing the BAND button This allows you to store your favorite satellite radio stations the memory for later recall.

1. Touch the [BAND] button to enter the preset list to select or save your presets.
2. Touch the corresponding Preset key (1 to 4) to recall the desired preset station.

* There are 5 pages of preset memory space available for your use. You can scroll the pages using the scroll bar buttons to the right of the screen.
3. Touch the [BAND] key to return to the previous screen.

Deleting a preset

1. Touch the [BAND] button and enter the preset menu.
2. Select the preset you would like to delete by touching it in the preset menu.
3. Touch and hold the [DEL] button for more than 3 seconds.

Receiving stations selected by category

Satellite Radio allows you to select broadcast channel category (contents).

1. Touch the [||◀◀] or [▶▶|] key.

Scroll the category and select a channel

- 1-1. Touch the scroll bar buttons on the right to scroll through the available pages.
- 1-2. Touch the [||◀◀] or [▶▶|] key to scroll through the available categories.
- 1-3. Select your desired channel by touching it momentarily on the screen.
- 1-2. Touch the desired Category item key to select the category.
2. Touch the [LIST] button to exit category tuning mode.

Note:

- When the category selection mode is entered, the category of the last received channel is displayed first.

8. TROUBLESHOOTING

GENERAL

Problem	Cause	Measure
Power does not turn on. (No sound is produced.)	Fuse is blown.	Replace with a fuse of the same amperage. If the fuse blows again, consult your store of purchase.
	Incorrect wiring.	Consult your store of purchase.
Nothing happens when buttons are pressed. Display is not accurate.	The microprocessor has malfunctioned due to noise, etc.	Turn off the power and open the operation panel. Press the reset button with a thin rod. Note: <i>When the Reset button is pressed, turn off the ACC power.</i> * When the Reset button is pressed, frequencies of radio stations, titles, etc. stored in memory are cleared.
The remote control unit does not work.	Direct rays of the sun fall on the light-receptive part of the remote control unit.	When direct rays of the sun fall on the light-receptive part of the remote control unit, it may not work.
	The batteries of the remote control unit are dead or there is no battery in the remote control unit.	Check the batteries of the remote control unit.

DVD Player

Problem	Cause	Measure
Disc cannot be loaded.	Another disc is already loaded.	Eject the disc before loading the new one.
	There is a foreign matter already in place.	Eject the foreign matter forcibly.
Sound skips or is noisy.	Compact disc is dirty.	Clean the compact disc with a soft cloth.
	Compact disc is heavily scratched or warped.	Replace with a compact disc with no scratches.
Sound is bad directly after power is turned on.	Water droplets may form on the internal lens when the car is parked in a humid place.	Let dry for about 1 hour with the power on.
The image is not displayed.	The parking brake is not engaged.	Check that the parking brake is engaged.
Disc cannot play with the display "PARENTAL VIOLATION" shown.	Feature exceeds set parental level.	See the subsection "level"

9. ERROR DISPLAYS

If an error occurs, one of the following displays is displayed.
Take the measures described below to solve the problem.

DVD Player

Display	Cause	Measure
BAD DISC	A disc is caught inside the CD deck and is not ejected.	This is a failure of DVD deck's mechanism and consult your store of purchase.
BAD DISC	A disc cannot be played due to scratches, etc.	Replace with a non-scratched, non-warped disc.
BAD DISC	A disc is loaded upside-down inside the DVD deck and does not play.	Eject the disc then reload it properly.
PARENTAL VIOLATION	Parental level error	Set the correct Parental level.
WRONG REGION	Region code error	Eject the disc, and replace correct region code disc.

If an error display other than the ones described above appears, press the Reset button. If the problem persists, turn off the power and consult your store of purchase.

* When the Reset button is pressed, frequencies of radio stations, titles, etc. stored in memory are cleared.

10. SPECIFICATIONS

FM Tuner

Frequency Range: 87.9 MHz to 107.9 MHz
 Usable Sensitivity: 9 dBf
 50dB Quieting Sensitivity: 15 dBf
 Alternate Channel Selectivity: 70 dB
 Stereo Separation (1 kHz): 32 dB
 Frequency Response (± 3 dB): 30 Hz to 15 kHz

AM Tuner

Frequency Range: 530 kHz to 1710 kHz
 Usable Sensitivity: 28 dB μ V

DVD Player

System:
 Digital Versatile Disc System with CDDA capable
 Usable discs:
 DVD video disc, Compact disc
 Frequency Response:
 20 Hz to 20 kHz (CD) (± 1 dB)
 Dynamic Range: 100 dB (1 kHz)
 Distortion: 0.006%

Audio Amplifier

Maximum power output:
 160 W (40 W \times 4)
 Speaker impedance: 4 Ω (4 to 8 Ω allowable)

Input

Audio input:
 130 \pm 60mVrms (High)
 600 \pm 80mVrms (Mid)
 840 \pm 100mVrms (Low)
 (input impedance 10 k Ω or greater)
 Video input:
 1.0 \pm 0.2 Vp-p (input impedance 75 Ω)

Video Output

Video output:
 1.0 \pm 0.2 Vp-p (output impedance 75 Ω)

LCD Monitor

VRX485VD Screen Size: 7-inch wide type
 153 mm Width \times 87 mm Height
 MAX385VD Screen Size: 6.5-inch wide type
 141mm Width \times 78 mm Height

Display method:
 Transmission type TN liquid crystal display
 Drive method: TFT (thin-film transistor)
 active matrix driving
 Pixels: 336,960 (480 \times 3 (RGB) \times 234)

General

Power source voltage:
 14.4 V DC (10.8 to 15.6 V allowable)
 Ground: Negative
 Current consumption: 4.0 A (1 W)
 Auto Antenna Rated Current: 500 mA less
 MAX385VD Dimensions of the Main Unit:
 7" Width (178 mm) \times 3-15/16" Height
 (100 mm) \times 6-1/2" Depth (165 mm)
 MAX385VD Weight of the Main Unit: 2.8 kg
 VRX485VD Dimensions of the Main Unit:
 7" Width (178 mm) \times 2" Height
 (50 mm) \times 6-5/16" Depth (160 mm)
 VRX485VD Weight of the Main Unit: 2.15 kg

Dimensions of the Remote Control Unit:
 2-1/8" Width (54 mm) \times 9/16" Height
 (14 mm) \times 4-13/16" Depth (122 mm)
 Weight of the Remote Control Unit:
 50 g (including battery)

Note:

- Specifications comply with JEITA Standards.
- Specifications and design are subject to change without notice for further improvement.

Power Output:

18 W RMS \times 4 Channels at 4 Ω
 and 1 % THD+N

Signal to Noise Ratio:

76 dBA (reference: 1 W into 4 Ω)



INSTALLATION AND WIRE CONNECTION MANUAL

■ Contents

1. BEFORE STARTING.....	38
2. PACKAGE CONTENTS.....	38
3. GENERAL CAUTIONS.....	38
4. CAUTIONS ON INSTALLATION.....	39
5. INSTALLING THE MAIN UNIT.....	40
6. CAUTIONS ON WIRING.....	42
7. WIRE CONNECTION.....	43

1. BEFORE STARTING

1. This set is exclusively for use in cars with a negative ground 12 V power supply.
2. Read these instructions carefully.
3. Be sure to disconnect the battery “-” terminal before starting. This is to prevent short circuits during installation. (Figure 1)

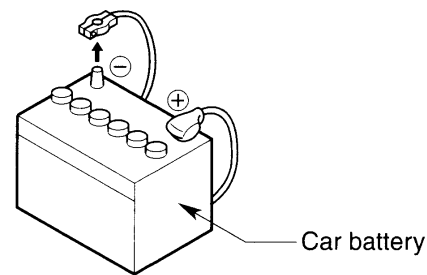

Figure 1

2. PACKAGE CONTENTS

- | | |
|---|---|
| 1. Main unit | 5. Remote control unit |
| 2. Manuals
Owner's manual & Installation manual
Warranty card | 6. Battery
(installed in remote control unit) |
| 3. Power supply cord | 7. Finishers |
| 4. Bag for accessories (No. 1)
Flat head screw (M5 × 8)..... 8 or 4
Sems hexagonal bolt (M5 × 8)..... 8 or 4 | |

3. GENERAL CAUTIONS

1. Do not open the case. There are no user-serviceable parts inside. If you drop anything into the unit during installation, consult your dealer or an authorized Clarion service center.
2. Use a soft, dry cloth to clean the case. Never use a rough cloth, thinner, benzine, or alcohol, etc. For tough dirt, apply a little cold or warm water to a soft cloth and wipe off the dirt gently.

4. CAUTIONS ON INSTALLATION

1. Prepare all articles necessary for installing the main unit before starting.
2. This model features an operation panel that slides forward. On some types of cars, the operation panel may make contact with the dashboard or gearshift lever, in which cause it cannot be installed. Before installing, check that the unit will not hamper operation of the gearshift lever or obstruct your view before selecting the installation location. (Figure 2)

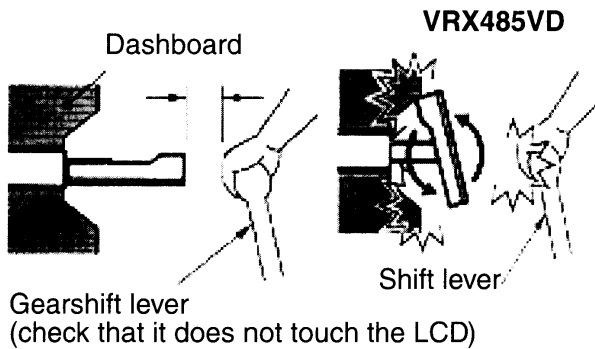
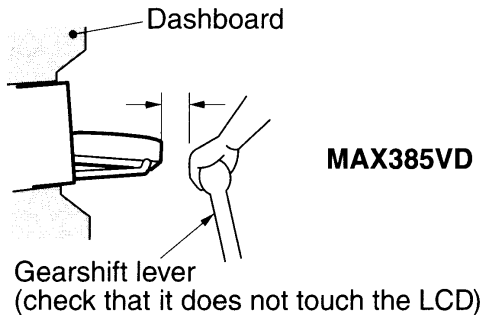

Figure 2

3. Install the unit within 30° of the horizontal plane. (Figure 3)

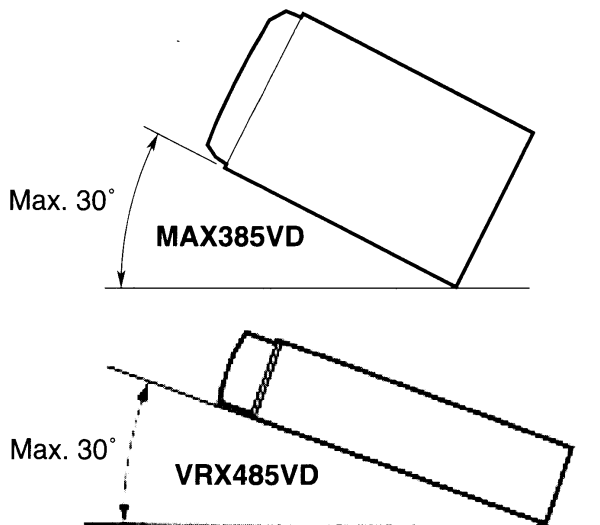

Figure 3

4. If you have to do any modification on the car body, such as drilling holes, consult your car dealer beforehand.
5. Use the included screws for installation. Using other screws can cause damage. (Figure 4)

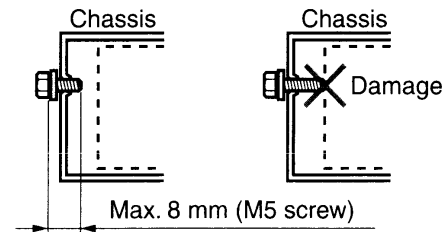

Figure 4

6. This unit has a fan motor in the back of the main unit so as not to raise the temperature in the main unit. When the fan motor vent is covered with cords or mounting bracket, it may cause a malfunction. Be sure not to cover it when wiring cords.

5. INSTALLING THE MAIN UNIT

This unit is designed for fixed installation in the dashboard.

1. When installing the main unit in NISSAN vehicles, use the parts attached to the unit and follow the instructions in Figure 6. When installing the main unit in TOYOTA vehicles, use the parts attached to the vehicle and follow the instructions in Figure 7.
2. Wire as shown in Section 7 (see page 72).
3. Reassemble and secure the unit in the dashboard and set the face panel and center panel.

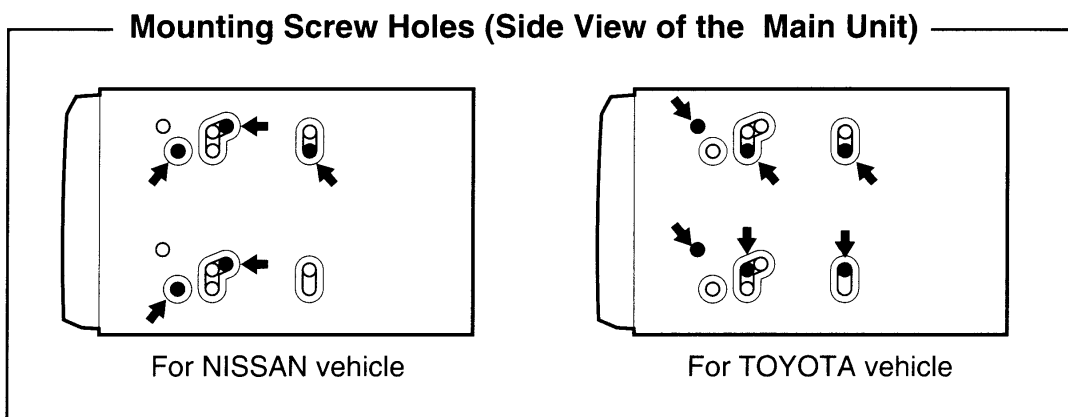

Installing the Main Unit in a NISSAN Vehicle

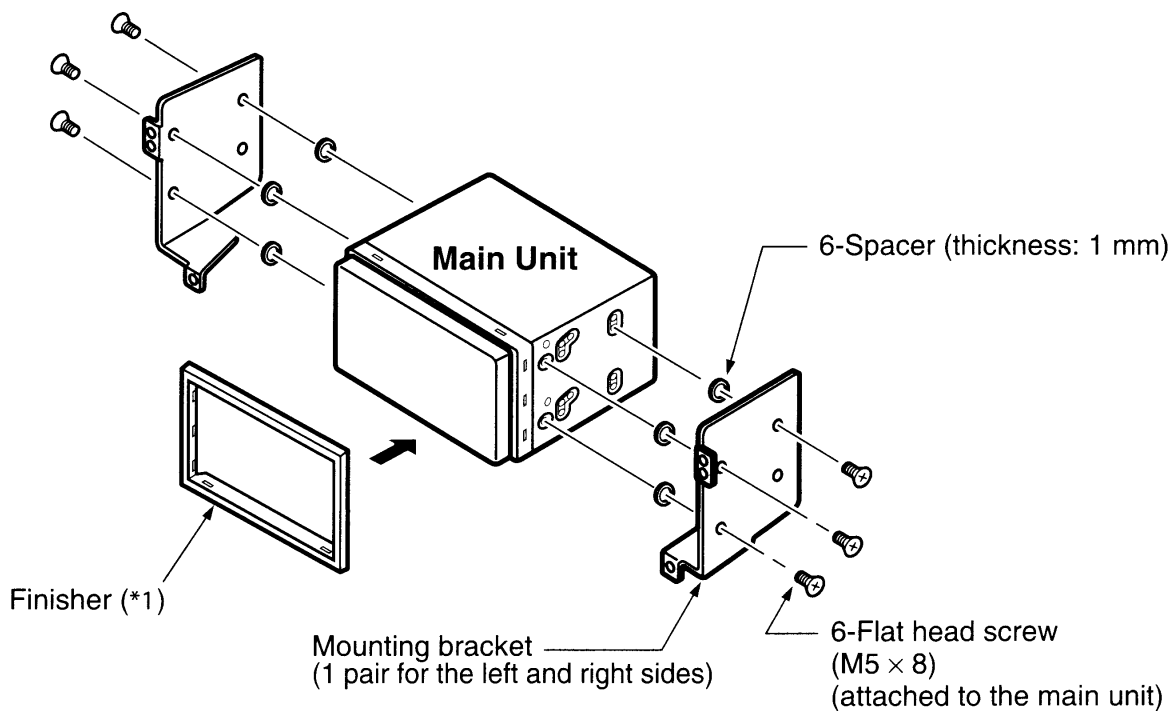

Figure 6

Note:

*1: Position the face panel with its wide edge at the bottom. Fit the edge into the groove of the main unit.

Installing the Main Unit in a TOYOTA Vehicle

Install by using parts attached to the vehicle. (Screws marked ★ are attached to the vehicle.)

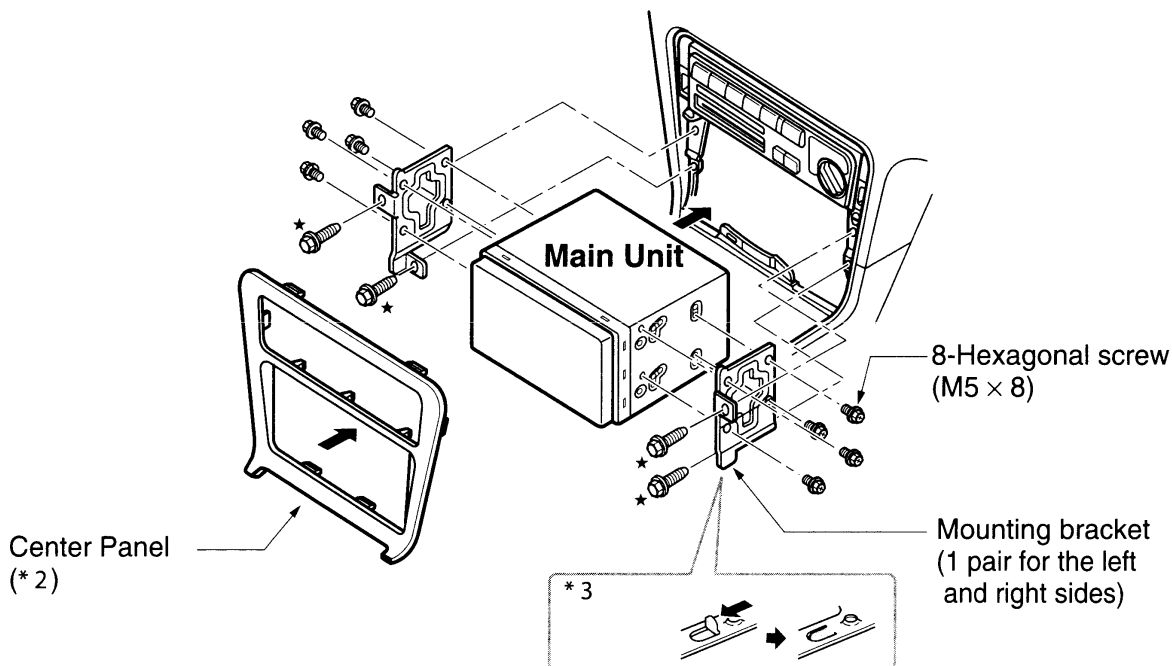
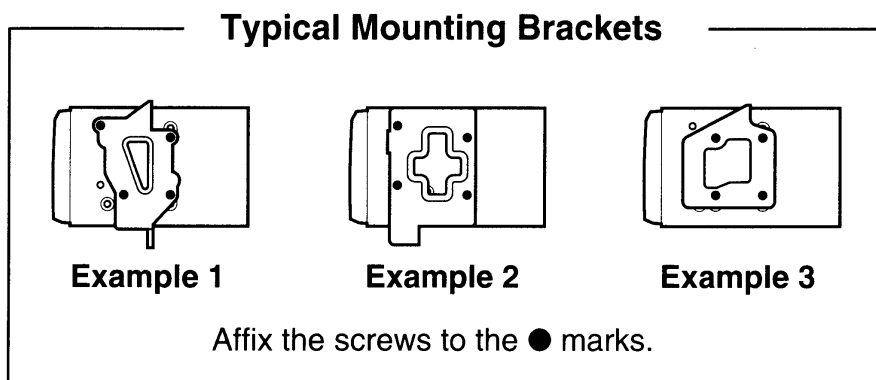

Figure 7

Note:

*2: Some panel openings are too small for the unit depending on the vehicle type and model. In such a case, trim the upper and lower sides of the panel frame by about 0.5 to 1.5 mm so the unit can be inserted smoothly.

*3: If a hook on the installation bracket interferes with the unit, bend and flatten it with a nipper or similar tool.



Vehicles other than NISSAN and TOYOTA

In some cases the center panel may require modification. (Trimming, filing, etc.)

● Removing the Main Unit

When the main unit is to be removed, disassemble it in the reverse of the order in "INSTALLING THE MAIN UNIT" (see page 48).

6. CAUTIONS ON WIRING

1. Be sure to turn the power off before wiring.
2. Be particularly careful where you route the wires.
Keep them well away from the engine, and exhaust pipe, etc. Heat may damage the wires.
3. If the fuse should blow, check to see if the wiring is correct.
If a fuse is blown, replace it with a new one of the same amperage rating as the original (15A FUSE).
4. To replace the fuse, remove the old fuse of the power supply cord and insert the new one. (Figure 8)

Note:

- There are various types of fuse holder. Do not let the battery side touch other metal parts.

⚠ CAUTION

After the connection, fix the cord by a clamp or insulation tape for protection.

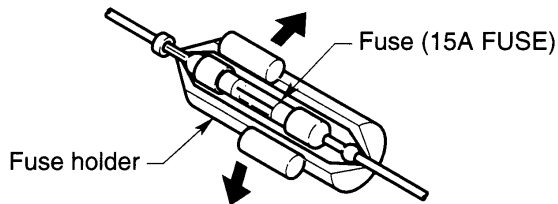

Figure 8

7. WIRE CONNECTION

Note:

- Before installing, be sure to disconnect the negative ⊖ cable of the car battery.
- In the optional devices, the RCA cables and the Connector cables are separately-sold items.

MAX385VD

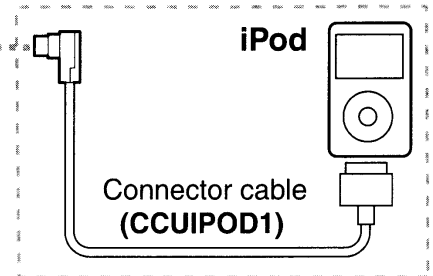
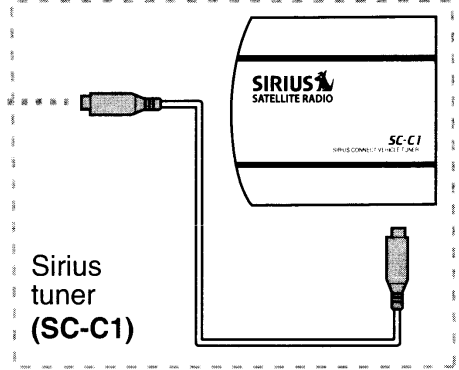
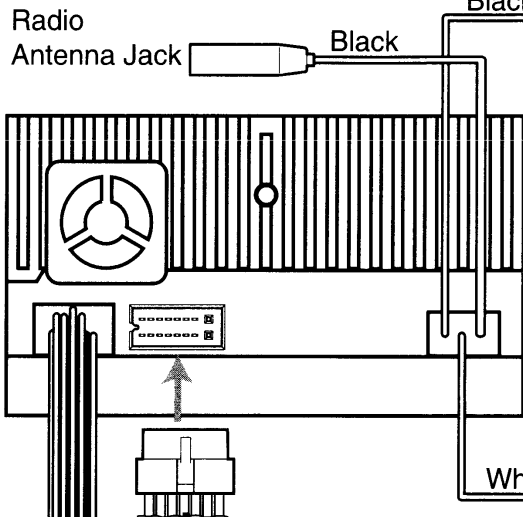

- Purple Red Line Out Subwoofer
- Purple White Line Out Subwoofer
- Gray Red Line Out Rear R
- Gray White Line Out Rear L
- Black Red Line Out Front R
- Black White Line Out Front L

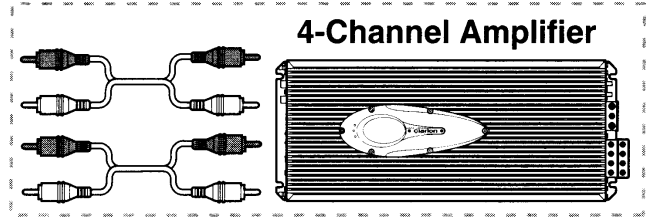

- Black Yellow Rear Monitor
- Red White AUX In/L
- Red Red AUX In/R
- Black Yellow AUX In Video

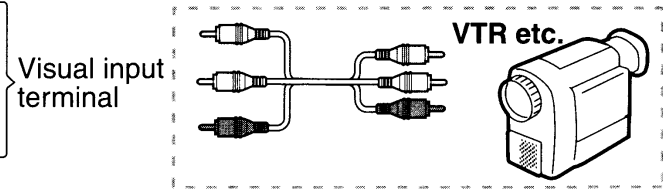
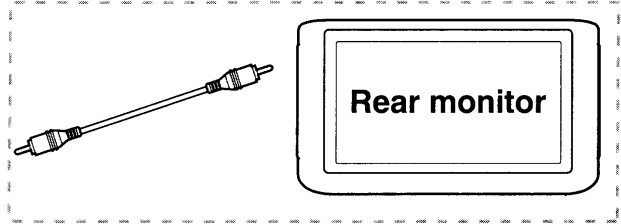

VRX485VD

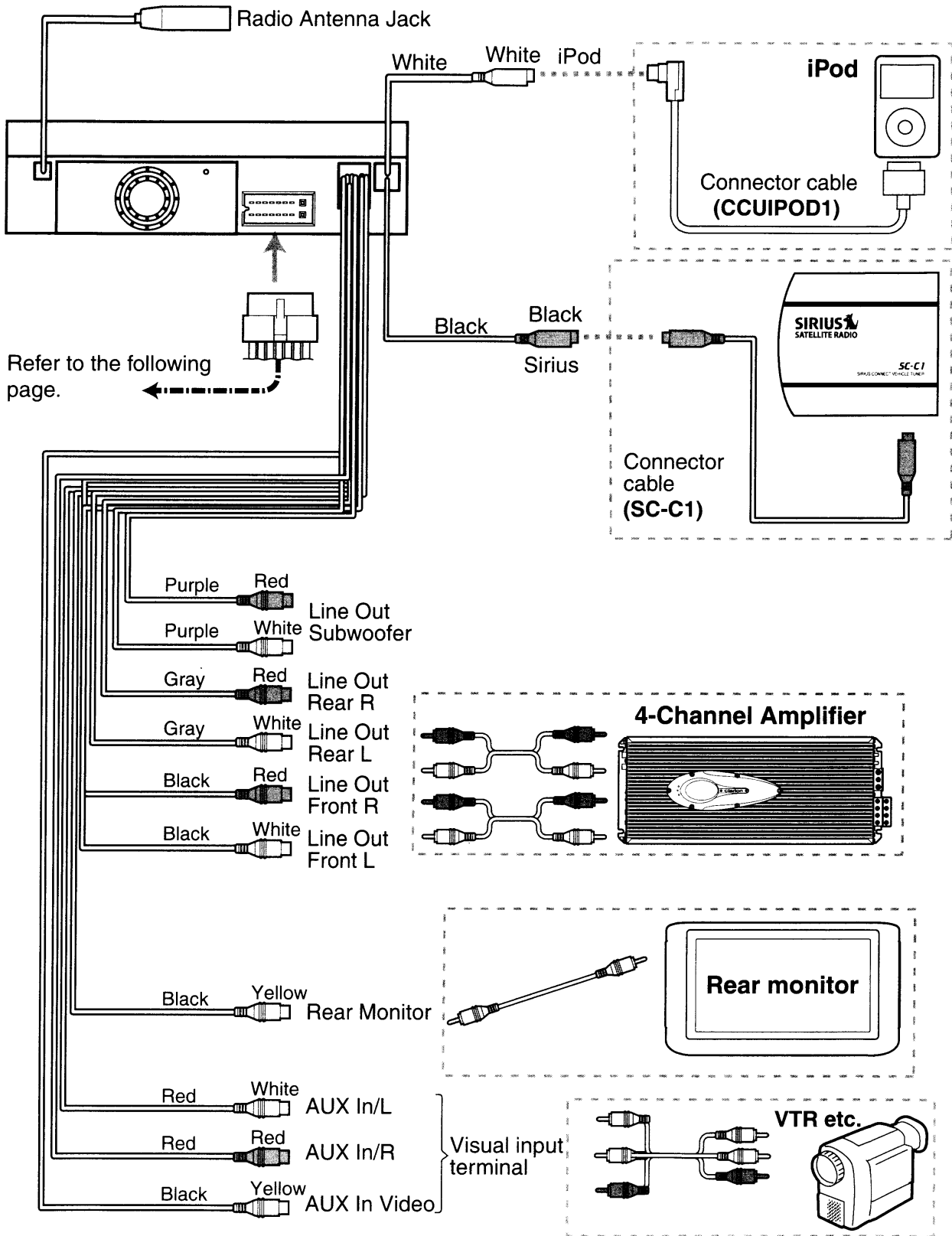

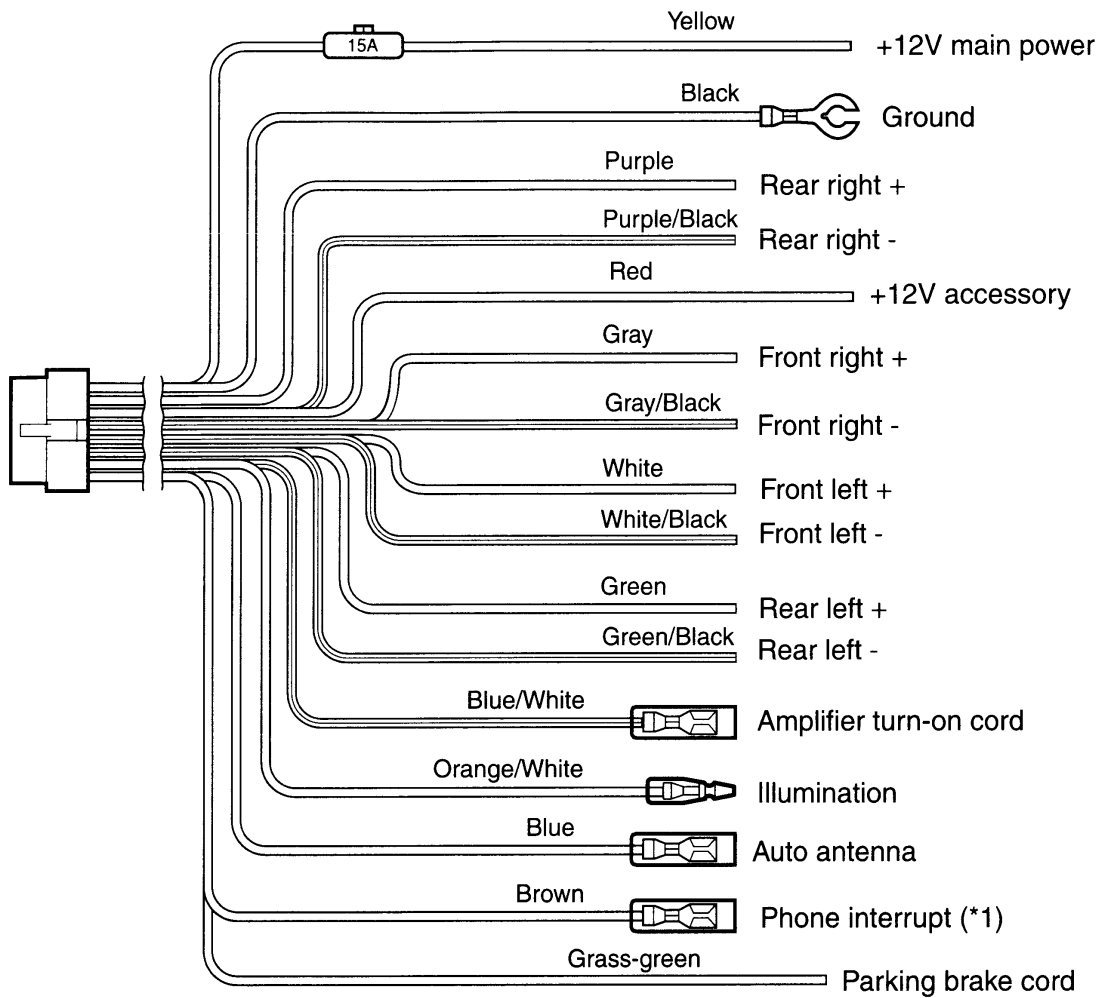
**Note:**

*1: Connecting the PHONE INTERRUPT terminal

The phone interrupt will mute the audio if the lead receives a negative or ground signal.

See next page for how to connect the parking brake cord.

●Connecting the parking brake cord

Connect the cord to parking brake lamp ground in the meter panel.

Note:

- Connecting the parking brake cord to lamp ground allows you to watch iPod video/DVD video/AV input when the parking brake is engaged.
- When the parking brake cord is not connected, the monitor will not show any video sources.
- If "AUDIO ONLY" appears on the screen just after turning on the ACC power of the car, release the parking brake while confirming safety, and then engage the parking brake again.

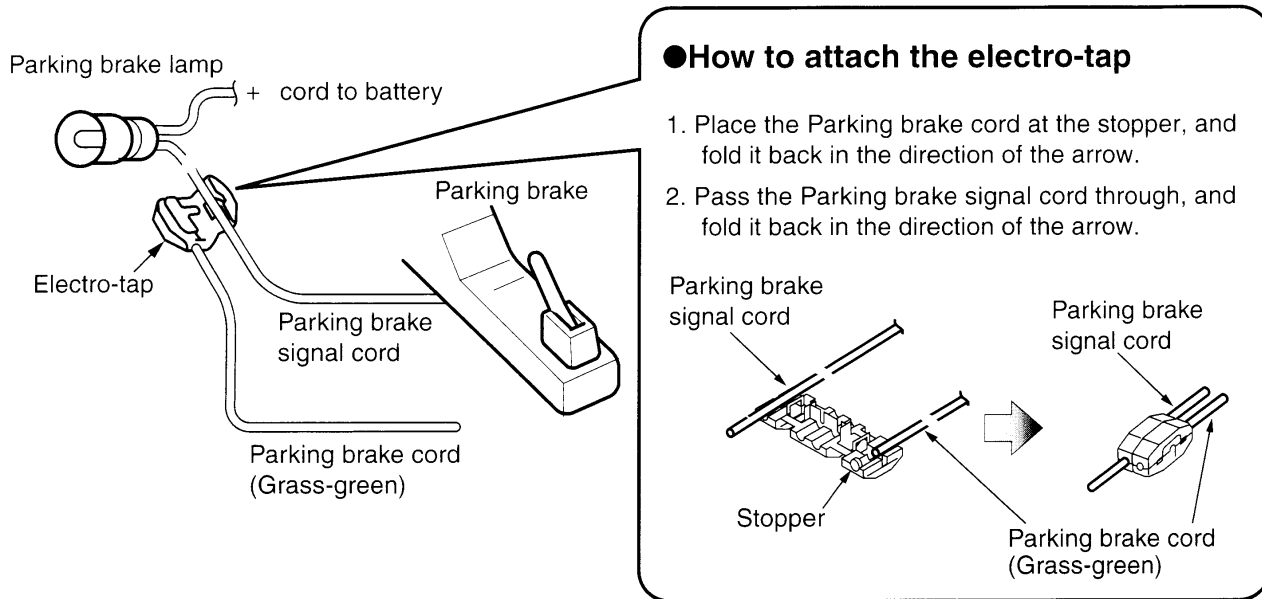

Connecting the Accessories

●Connection to the external amplifier

The external amplifiers can be connected to the 6 channel RCA output connections. Ensure that the connectors are not grounded or shorted to prevent damage to the unit.

●Connection to iPod devices

The iPod device can be connected to dedicated iPod connection on the main unit. For detailed information, refer to the instruction sheet or manual for the iPod cable.

Note:

- This unit may not support all functions of all iPod devices
 - The iPod connection will charge your iPod unless the iPod battery is completely depleted.
- If the specified cord of the cellular phone is connected to the phone interrupt cord of the main unit, the audio mute is available when the cellular phone is used.
- Sirius Satellite Radio Receiver

When a Sirius Satellite Radio Receiver is to be connected, use the dedicated connector. For detailed information, refer to the instruction manual of the Sirius Satellite Radio Receiver.

Clarion Co., Ltd.

All Rights Reserved. Copyright © 2007: Clarion Co., Ltd.
Printed in China / Imprimé au Chine / Impreso en China

2008/02

VRX485VD/MAX385VD

Ce produit Clarion vendu par marchand autorisé Clarion est garanti contre tous défauts de matériel et de mise en œuvre pour une durée de **un (1) an** à compter de la date de vente initiale quand l'achat **ET** l'installation ont été effectués chez un marchand autorisé Clarion.

Tous câblages, fils et autres accessoires Clarion achetés chez un marchand autorisé Clarion, sont garantis contre tous défauts de matériel et de mise en œuvre pour une durée de quatre-vingt-dix (90) jours de la date d'achat initiale.

TOUT ACHAT DE PRODUITS CLARION EFFECTUÉ CHEZ UN MARCHAND NON-AUTORISÉ CLARION SERA SOUMIS À DES RESTRICTIONS DE GARANTIES DÉCRI CI-DESSOUS.

Les conditions de cette garantie limitée et l'implication de la responsabilité de Clarion Corporation of America "Clarion" sous cette garantie limitée sont les suivantes:

1. **DANS LE CAS DE LA GARANTIE LIMITÉE DE UN (1) AN, UNE PREUVE D'ACHAT ET UNE PREUVE D'INSTALLATION SONT REQUISES. DES INFORMATIONS SUPPLÉMENTAIRES CONCERNANT LES CENTRES DES SERVICES AUTORISÉS PAR CLARION PEUVENT ÊTRE OBTENUES AUX ADRESSES À LA FIN DE CE DOCUMENT.**
2. Cette Garantie Limitée sera annulée si un dommage est survenu au bien lors d'un service effectué par personne ou entreprise qui n'est pas accrédité comme un Centre de Service et Garantie Clarion.
3. Cette Garantie Limitée n'est pas applicable à un aucun produit sujet à l'abus, négligence, accidentés, installation ou utilisation incorrects ou que les numéros de série ont été modifiés, obstrué ou effacé, ou qui a été raccordés, installés, ajustés ou réparés autrement indiqué par Clarion.
4. Cette Garantie Limitée ne couvre pas des interférences électrostatiques, électriques, ni les ajustements ou nettoyage de la tête de lecture (en cas de radio cassette) ou éléments laser, ni les frais reliés à la manutention pour le retrait ou la réinstallation
5. La responsabilité de Clarion sous cette Garantie Limitée est limitée uniquement à la réparation ou au remplacement du produit, qui est sujet uniquement à la discrétion de Clarion.
6. Ce produit doit être livré dans son emballage d'origine ou équivalent. Le colis doit être entièrement assuré et tous frais de transport doivent être prépayés. Clarion n'assumera aucune responsabilité en cas de perte ou dommages survenue lors du transport.
7. **TOUS PRODUITS CLARION ACQUIS PAR UNE ENTREPRISE AUTRE QU'UN MARCHAND AUTORISÉ PAR CLARION, INCLUANT TOUS ACHATS VIA UN MARCHAND VIRTUEL (ACHAT INTERNET) QUI N'EST PAS AUTORISÉ PAR CLARION, NE SONT PAS COUVERTS PAR LES GARANTIES LIMITÉES DE CLARION, ET CE, EN ACCORD AVEC LES LIMITATIONS DÉFINIES PAR LA LOI. DANS LE CAS OÙ LES LOIS APPLICABLES NE PERMETTENT PAS L'ÉLIMINATION DES GARANTIES SOUS CES CONDITIONS, LA PÉRIODE DE GARANTIE LIMITÉE QUI S'APPLIQUE AU PRODUIT SERA DE QUINZE (15) JOURS À PARTIR DE LA DATE D'ACHAT INITIALE.**
8. **AUCUNE GARANTIE IMPLICITE NE POURRA S'ÉTENDRE AU-DELÀ DE LA PÉRIODE DE GARANTIE DÉCRITE CI-DESSUS, ET CE, EN ACCORD AVEC LES LIMITES DÉFINIES PAR LA LOI. CLARION NE POURRA EN AUCUN CAS ÊTRE TENUE RESPONSABLE DES PERMETS OU DOMMAGES DIRECTS OU INDIRECTS DU À L'UTILISATION OU L'IMPOSSIBILITÉ D'UTILISATION DU PRODUIT. PUISQUE CERTAINS ÉTATS NE PERMETTENT PAS DE LIMITER LA DURÉE DES GARANTIES IMPLICITES, OU DE LIMITER LA RESPONSABILITÉ EN CAS DE DOMMAGES DIRECTS OU INDIRECTS, CES LIMITATIONS OU EXCLUSIONS PEUVENT NE PAS S'APPLIQUER À VOUS.**
9. **CETTE GARANTIE LIMITÉE VOUS DONNE DES DROITS LÉGAUX PRÉCIS. VOUS POUVEZ POSSÉDER DES DROITS SUPPLÉMENTAIRES SELON VOTRE LIEU DE RÉSIDENCE.**
10. Les lois de l'état de la Californie contrôlent totalement cette garantie limitée, son interprétation et sa mise en exécution.
11. Si vous éprouvez des problèmes de performance du produit pendant la période de garantie, veuillez communiquer avec Clarion ou visitez notre site Web à l'adresse ci-dessous afin d'obtenir une résolution de tout problème relié aux produits Clarion.

Aux États-Unis:
 Clarion Corporation of America
 Attn:Customer Service Manager
 6200 Gateway Drive Cypress, CA 90630
 1-800-GO-CLARION
 www.clarion.com

Au In Canada:
 Clarion Canada Inc.
 Centre de Service et Garantie
 2239 Winston Park Drive Oakville,
 Ontario L6H 5R1 (905)829-4600
 www.clarion.com

clarion[®]**CLARION 1 YEAR LIMITED WARRANTY**

For USA and Canada only

This Clarion product purchased from an authorized Clarion dealer are warranted against all defects in materials and workmanship for a period of **one (1) year** from the date of original purchase, when purchased from **AND** installed by an authorized Clarion dealer.

All Clarion cables, wires and other accessories if purchased from an authorized Clarion dealer are warranted against all defects in materials and workmanship for ninety (90) days from the date of original purchase.

ALL PURCHASES OF CLARION PRODUCTS FROM NON-AUTHORIZED CLARION DEALERS ARE SUBJECT TO FURTHER WARRANTY RESTRICTIONS AS DESCRIBED BELOW.

The conditions of this Limited Warranty and the extent of responsibility of Clarion Corporation of America ("Clarion") under this Limited Warranty are as follows :

1. **PROOF OF DATE OF PURCHASE FROM AN AUTHORIZED CLARION DEALER WILL BE REQUIRED FOR WARRANTY SERVICE OF THIS PRODUCT. CENTERS MAY BE OBTAINED BY CONTACTING CLARION AT THE ADDRESS LISTED BELOW.**
2. This Limited Warranty will become void if service performed by anyone other than an approved Clarion Warranty Service Center results in damage to the product.
3. This Limited Warranty does not apply to any product which has been subject to misuse, neglect or accident, or which has had the serial number altered, defaced or removed, or which has been connected, installed, adjusted or repaired, other than in accordance with the instructions furnished by Clarion.
4. This Limited Warranty does not cover car static or other electrical interferences, tape head or laser pick-up cleaning or adjustments, or labor costs for the removal or reinstallation of the unit for repair.
5. The sole responsibility of Clarion under this Limited Warranty shall be limited to the repair of the product or replacement of the product, at the sole discretion of Clarion.
6. Product must be shipped in its original carton or equivalent carton, fully insured, with shipping charges prepaid. Clarion will not assume any responsibility for any loss or damage incurred in shipping.
7. **CLARION PRODUCTS PURCHASED FROM A SOURCE OTHER THAN AN AUTHORIZED CLARION DEALER, INCLUDING ANY AND ALL PURCHASES VIA THE INTERNET FROM A NON INTERNET AUTHORIZED CLARION DEALER, SHALL NOT BE COVERED BY ANY CLARION LIMITED WARRANTY TO THE EXTENT ALLOWED BY APPLICABLE LAW. IN THE EVENT AND TO THE EXTENT APPLICABLE LAW PROHIBITS ELIMINATION OF WARRANTIES UNDER THESE CIRCUMSTANCES, THE APPLICABLE LIMITED WARRANTY PERIOD SHALL BE DEEMED TO BE FIFTEEN (15) DAYS FROM THE DATE OF ORIGINAL PURCHASE.**
8. **ALL IMPLIED WARRANTIES EXCEPT TO THE EXTENT PROHIBITED BY APPLICABLE LAW SHALL HAVE NO GREATER DURATION THAN THE WARRANTY PERIOD SET FORTH ABOVE. UNDER NO CIRCUMSTANCES SHALL CLARION BE LIABLE FOR ANY LOSS OR DAMAGE, DIRECT OR CONSEQUENTIAL, ARISING OUT OF THE USE OR INABILITY TO USE THE PRODUCT. BECAUSE SOME STATES DO NOT ALLOW LIMITATIONS ON HOW LONG AN IMPLIED WARRANTY LASTS OR EXCLUSIONS OR LIMITATIONS OF INCIDENTAL OR CONSEQUENTIAL DAMAGES, THE ABOVE LIMITATIONS OR EXCLUSIONS MAY NOT APPLY TO YOU.**
9. **THIS LIMITED WARRANTY GIVES YOU SPECIFIC LEGAL RIGHTS, AND YOU MAY ALSO HAVE OTHER RIGHTS WHICH VARY FROM STATE TO STATE.**
10. The laws of the State of California shall govern and control this Limited Warranty, its interpretation and enforcement.
11. Should you have any difficulties with the performance of this product during the warranty period, please call Clarion or visit our web site for a listing of Authorized Warranty Service Centers in your area. You may also contact Clarion Customer Service at the address listed below for any service help you may need with Clarion products.

In USA:
Clarion Corporation of America
Attn:Customer Service Manager
6200 Gateway Drive
Cypress, CA 90630
1-800-GO-CLARION
www.clarion.com

In Canada:
Clarion Canada Inc.
Warranty Service Center
2239 Winston Park Drive
Oakville, Ontario L6H 5R1
(905) 829-4600
www.clarion.com

Free Manuals Download Website

<http://myh66.com>

<http://usermanuals.us>

<http://www.somanuals.com>

<http://www.4manuals.cc>

<http://www.manual-lib.com>

<http://www.404manual.com>

<http://www.luxmanual.com>

<http://aubethermostatmanual.com>

Golf course search by state

<http://golfingnear.com>

Email search by domain

<http://emailbydomain.com>

Auto manuals search

<http://auto.somanuals.com>

TV manuals search

<http://tv.somanuals.com>