

Clarion®

Owner's manual & Installation manual
Mode d'emploi et manuel d'installation
Manual de instrucciones y de instalación

VRX630

6.5" MONITOR & FM/AM RADIO WITH CD/MD/DVD
CHANGER CONTROL

MONITEUR DE 6,5 POUCES ET RADIO FM/AM AVEC
COMMANDE DE CHANGEUR DE CD/MD/DVD

MONITOR DE 6,5-PULGADAS Y RADIO FM/AM CON
MANDO PARA EL CAMBIADOR DE CD/MD/DVD

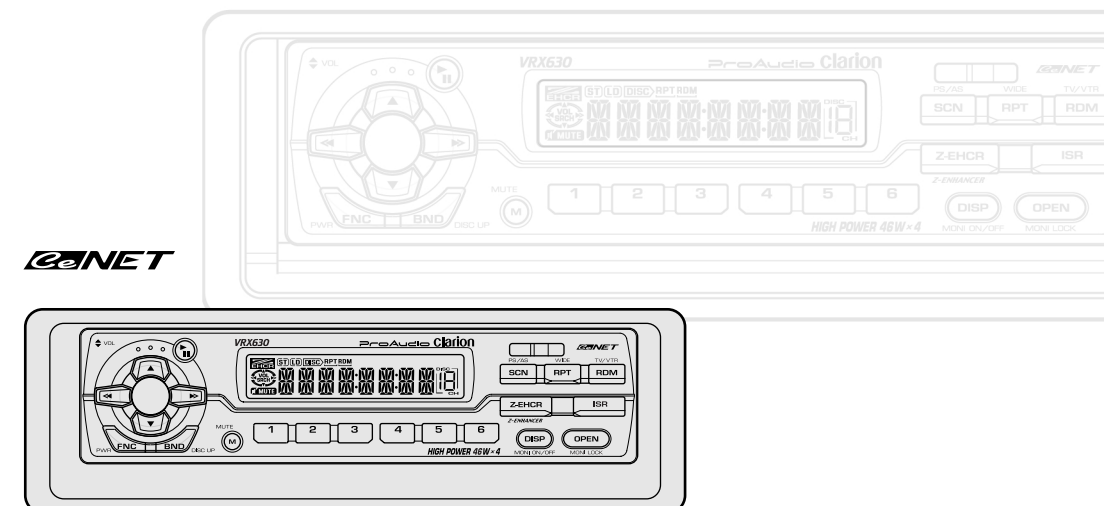

Clarion Co., Ltd.

All Rights Reserved. Copyright © 2003: Clarion Co., Ltd.
Printed in China / Imprimé en Chine / Gedruckt in China / Stampato in Cina
Gedruckt in China / Impreso en China / Tryckt i Kina / Impresso na China

QC-6710B
280-7946-00

2003/01 (D-C)

Thank you for purchasing the Clarion VRX630.

- * This owner's manual is for the VRX630.
- * Please read this owner's manual in its entirety before operating this equipment.
- * After reading this manual, be sure to keep it in a handy place (e.g., glove compartment).
- * Check the contents of the enclosed warranty card and keep it carefully with this manual.
- * This manual includes the operating procedures of the CD changer, MD changer, DVD changer, TV tuner connected via the CeNET cable. The CD changer, MD changer, DVD changer, TV tuner have their own manuals, but no explanations for operating them are described.

Contents

1. PRECAUTIONS	4	8. OPERATIONS	15
2. CAUTIONS ON HANDLING	4	Basic Operations	15
LCD panel/Generalities	4	Radio Operations	18
Cleaning	4	CD Changer Operations	23
3. CONTROLS	5	MD Changer Operations	25
4. NOMENCLATURE	6	DVD Changer Operation	27
Names of Buttons	6	TV Operations	31
JOYSTICK Operation	7	CCD Camera	39
5. MODE DISPLAY	8	Connecting other company's image equipment	40
Display common to each mode	8	Other Functions	40
TITLE LIST mode display	8	DSP Operations	31
RADIO mode display	9	9. IN CASE OF DIFFICULTY	43
RDS mode display	9	10. ERROR DISPLAYS	45
CD/MD Changer mode display	10	11. SPECIFICATIONS	46
TV mode display	10		
6. DCP	11		
7. REMOTE CONTROL	12		
Inserting the Batteries	12		
Functions of Remote Control Unit			
Buttons	13		

5. MODE DISPLAY

The Color LCD Display and the Information Panel on the main unit show the following displays, providing information about the mode and functions operated.

Display common to each mode

COLOR LCD DISPLAY

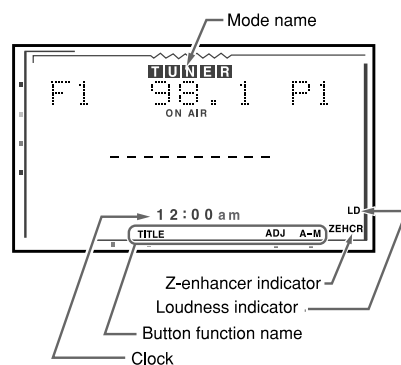

INFORMATION PANEL

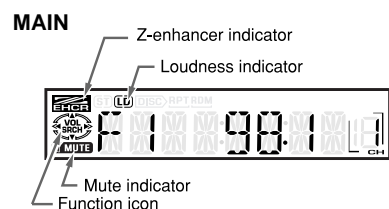

Clock Time display

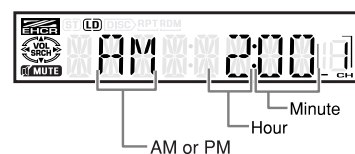

TITLE LIST mode display

COLOR LCD DISPLAY

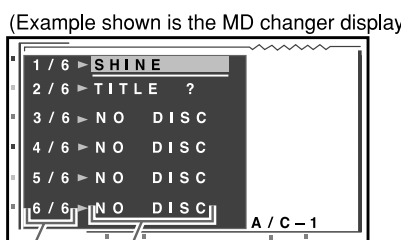

- Disc title
- When the title is not set "TITLE ?" is displayed
- When no disc is set in the changer "NO DISC" is displayed

INFORMATION PANEL

1. PRECAUTIONS

WARNING

For your safety, the driver should not watch the TV or operate the controls while driving. Please note that watching and operating the TV while driving are prohibited by law in some countries. Also, while driving, keep the volume to a level at which external sounds can be heard.

- This unit uses a precision mechanism. Even in the event that trouble arises, never open the case, disassemble the unit, or lubricate the rotating parts.

2. TV broadcast reception

When receiving the TV broadcasts, the strength of the signals changes since the car is moving, so in some cases it may not be possible to receive clear pictures.

- TV signals are strongly linear, so reception is affected by buildings, mountains and other obstacles.
- Such external factors such as electric train lines, a high voltage lines, and signal devices may disturb the picture or cause noise.

* If the reception is poor, switch to a station with good reception.

INFORMATION FOR USERS:

CHANGES OR MODIFICATIONS TO THIS PRODUCT NOT APPROVED BY THE MANUFACTURER WILL VOID THE WARRANTY AND WILL VIOLATE FCC APPROVAL.

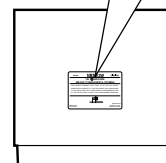
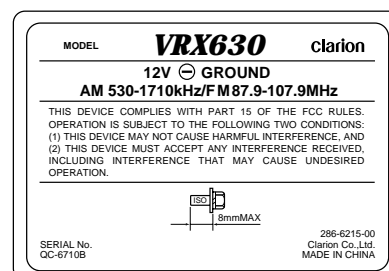

2. CAUTIONS ON HANDLING

LCD panel/Generalities

For a longer service life, be sure to read the following cautions.

- Be sure to store the LCD panel inside the main unit when parking the car outdoors for long period of time. The LCD panel will operate properly in a temperature range of 0 to 60°C.
- Don't allow any liquids on the set from drinks, umbrellas etc. Doing so may damage the internal circuitry.
- Do not disassemble or modify the set in any way. Doing so may result in damage.
- Do not draw the LCD panel out and use it as a tray. Also, subjecting the LCD panel to shocks may result in breakage, deformation or other damage.
- Do not let cigarettes burn the display. Doing so may damage or deform the cabinet.
- If a problem should occur, have the set inspected at your store of purchase.
- Do not insert objects or poke in the space between the LCD panel and the main unit when the panel is tilted.
- Do not place anything on the display when the panel is tilted.
- The remote controller may not work if the remote control sensor is exposed to direct sunlight.
- In extremely cold weather, the display movement may slow down and the display may darken, but this is not a malfunction. The display will work normally when the temperature increases.
- Small black and shiny spots inside the LCD panel are normal for LCD products.
- The LCD panel may stop temporarily when it opens or closes, when the engine stops or when it is cold.

Cleaning

• Cleaning the cabinet

Use a soft, dry cloth and gently wipe off the dirt. For tough dirt, apply some neutral detergent diluted in water to a soft cloth, wipe off the dirt gently, then wipe again with a dry cloth.

Do not use benzene, thinner, car cleaner, etc., as these substances may damage the cabinet or cause the paint to peel. Also, leaving rubber or plastic products in contact with the cabinet for long periods of time may cause stains.

• Cleaning the LCD panel

The LCD panel tends to collect dust, so wipe it off occasionally with a soft cloth. The surface is easily scratched, so do not rub it with hard objects.

Be sure to unfold and read the next page. / Veuillez déplier et vous référer à la page suivante. / Cerciórese de desplegar y de leer la página siguiente.

3. CONTROLS / COMMANDES / REGLER / CONTROLLI REGELAARS / CONTROLES / KONTROLLER

Main unit / Unité principale / Unidad principal

With the Display closed / Avec l'afficheur fermé / Con el visualizador cerrado

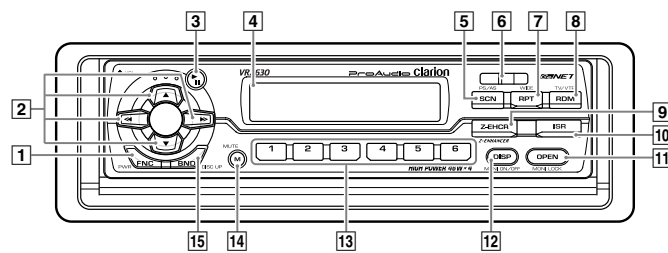

With the Display open / Avec l'afficheur ouvert / Con el visualizador abierto

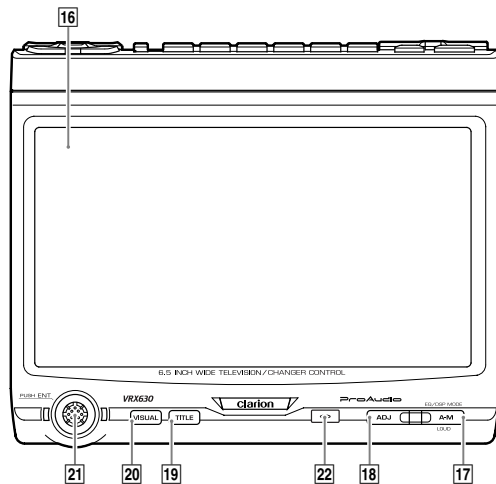

Note: Be sure to unfold this page and refer to the front diagrams as you read each chapter.
Remarque: Veuillez déplier cette page et vous référer aux schémas quand vous lisez chaque chapitre.
Nota: Cuando lea los capítulos, despliegue esta página y consulte los diagramas.

4. NOMENCLATURE

Names of Buttons

Note:

• Be sure to read this chapter referring to the front diagrams of chapter "3. CONTROLS" on page 5 (unfold).

With the display closed

- 1 POWER button
- 2 FNC (Function) button
- 3 SEARCH button
- 4 VOLUME button
- 5 ◀ button
- 6 ▶ button
- 7 PLAY/PAUSE button
- 8 Information Panel
- 9 PS (Preset scan)/AS (Auto store) button
- 10 SCN (Scan) button
- 11 DCP RELEASE lever
- 12 WIDE button
- 13 RPT (Repeat) button
- 14 TV/VTR button
- 15 RDM (Random) button
- 16 Z-EHCR (Z-enhancer) button
- 17 ISR button
- 18 OPEN button
- 19 MONI LOCK (Monitor lock) button
- 20 DISP (Display) button
- 21 PRESET buttons (1 to 6)
- 22 DIRECT buttons (1 to 6)
- 14 MUTE button
- 15 BND (Band) button

With the display open

- 16 Color LCD display
- 17 A-M (Audio-Mode) button
- 18 ADJ (Adjust) button
- 19 TITLE button
- 20 VISUAL button
- 21 JOYSTICK
- 22 Remote Control Infrared Sensor

JOYSTICK Operation

Note:

- Many settings/procedures have to be performed by using the JOYSTICK [21]. Be sure to read this chapter in order to operate it properly.
- In the DVD changer mode, items for menu display, etc. can be selected by operating the JOYSTICK [21] upward, downward, leftward or rightward.

● Selecting an item in the menu

Select an item displayed in the menu by operating the JOYSTICK [21] upward or downward.

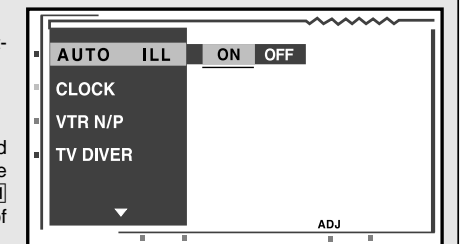

● Setting an option for the selected item

When the setting options for an item are listed on the right of the display, you can choose the desired option by operating the JOYSTICK [21] leftward or rightward. Then, press the center of the JOYSTICK [21] to set your choice.

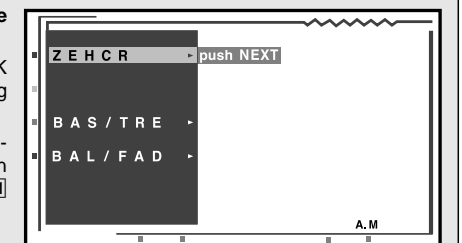

● When "push NEXT" is displayed next to the menu item

1. Press the ENT at the center of the JOYSTICK [21] to select the item and show the setting display for this item.
2. Operate the JOYSTICK [21] upward or downward to select the desired setting option, then press ENT at the center of the JOYSTICK [21] to set your choice.

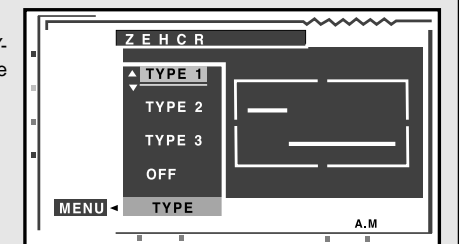

● Returning to the previous mode

Select the item "MENU" by operating the JOYSTICK [21] leftward or rightward, then press the ENT at the center of the JOYSTICK [21].

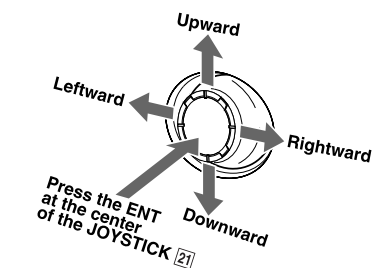

RADIO mode display

COLOR LCD DISPLAY

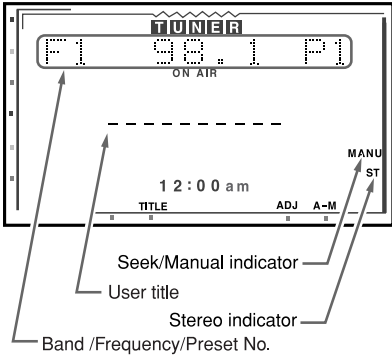

INFORMATION PANEL

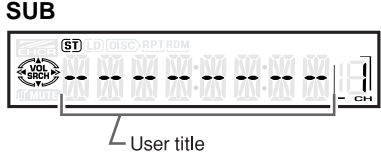
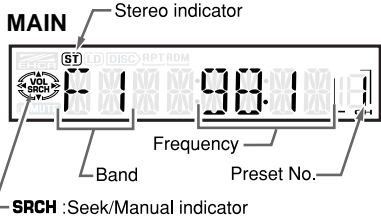

English
Owner's manual

CD/MD Changer mode display

COLOR LCD DISPLAY

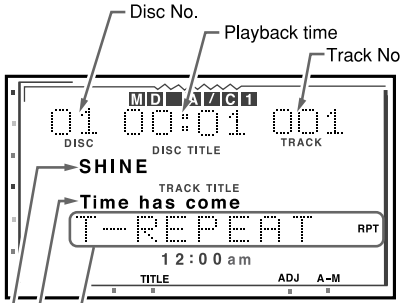

- When the play mode is selected, the display shows as follows:
- T-SCAN : Scan play
 - T-REPEAT, RPT : Repeat play
 - T-RANDOM, RDM : Random play
 - D-SCAN : Disk scan play
 - D-REPEAT, D-RPT : Disk repeat play
 - D-RANDOM, D-RDM : Disk random play

INFORMATION PANEL

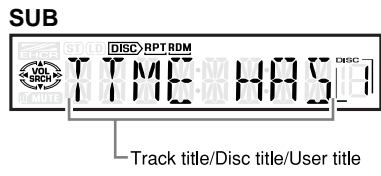
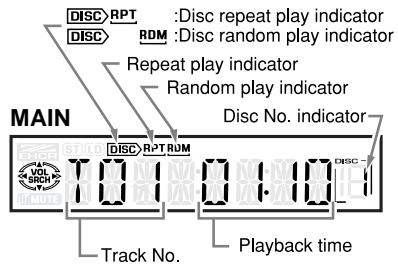

Track title
Disc title

DVD Changer mode display

COLOR LCD DISPLAY

While the car is moving, the screen below is displayed.

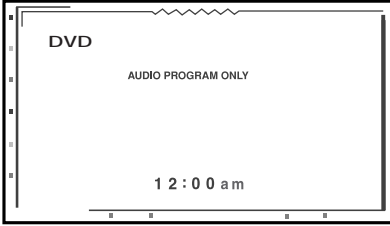

INFORMATION PANEL

MAIN



- No sub-indication

TV mode display

COLOR LCD DISPLAY

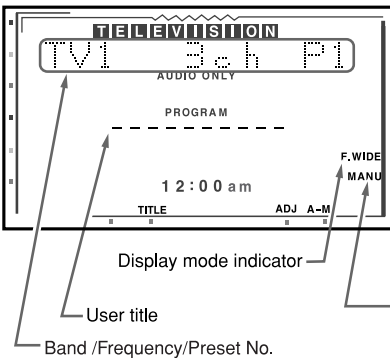

INFORMATION PANEL

MAIN

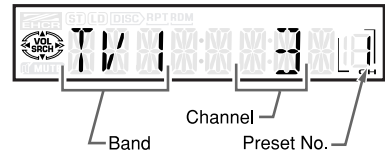

SUB

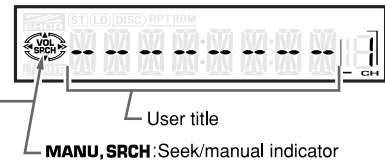

MANU, SRCH: Seek/manual indicator

6. DCP

The control panel can be detached to prevent theft. When detaching the control panel, store it in the DCP (DETACHABLE CONTROL PANEL) case to prevent scratches.

We recommend taking the DCP with you when leaving the car.

Removing the DCP

1. Turn the power off.
2. Deeply push in the DCP RELEASE lever  to release the DCP/Operation Panel.

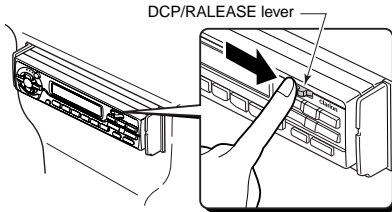

3. Pull the DCP toward you and remove it.

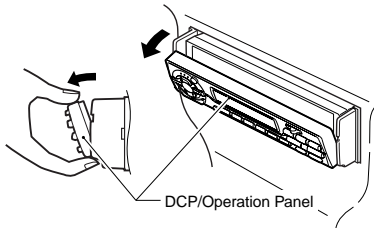

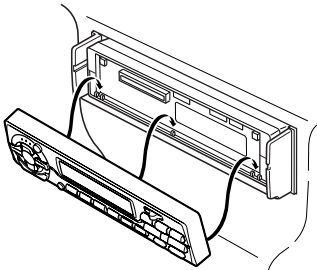

Attaching the DCP

1. Hold the DCP/Operation Panel with its rear side facing the main unit and, as shown in the figure below, put the lower edge of the panel onto the corresponding edge of the main unit.

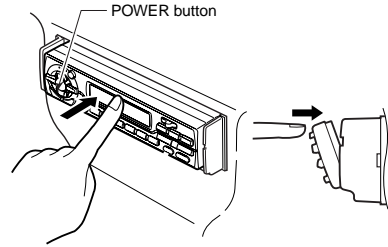

2. Lock the DCP/Operation Panel at the upper center until a click is heard.



3. Press the power button  to turn on the power.

* The unit will not accept any key inputs for 1 second after the DCP has been reattached.

CAUTION

- The DCP can easily be damaged by shocks. After removing it, be careful not to drop it or subject it to strong shocks.
- If the Operation Panel is kept open, the DCP may drop due to vibration of the car. This results in damage to the DCP. So close the Operation Panel or remove the DCP to store into the case.
- The connector connecting the main unit and the DCP is an extremely important part. Be careful not to damage it by pressing on it with fingernails, screwdrivers, etc.

Note:

- If the DCP is dirty, wipe off the dirt with a soft, dry cloth only.

7. REMOTE CONTROL

When the panel is open

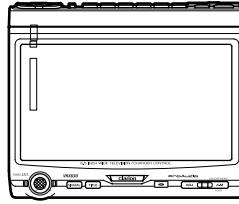

Remote control unit

Operating range: 30° in all directions

Signal transmitter

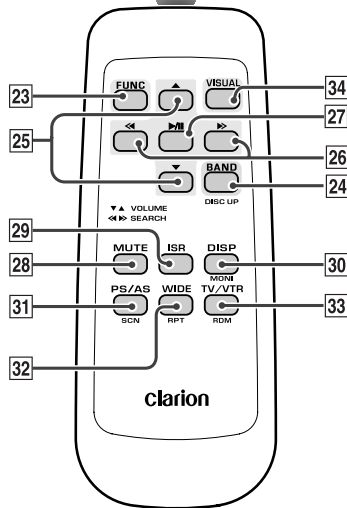

Inserting the Batteries

1. Turn the remote control unit over, then slide the rear cover in the direction of the arrow.
2. Insert the AA (SUM-3, IECR-6/1.5V) batteries that came with the remote control unit facing in the directions shown in the figure, then close the rear cover.

Notes:

Using batteries improperly can cause them to explode. Take note of the following points:

- When replacing batteries, replace both batteries with new ones.
- Do not short-circuit, disassemble or heat batteries.
- Do not dispose of batteries into fire or flames.
- Dispose of spent batteries properly.

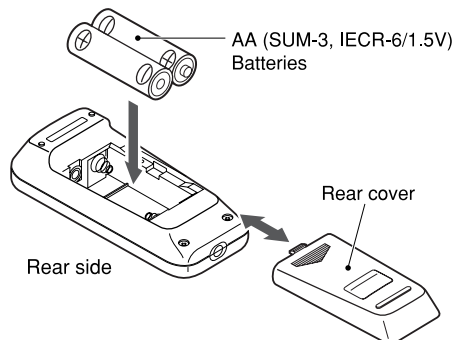

Functions of Remote Control Unit Buttons

Button	Mode	Radio	CD changer MD changer DVD changer	TV
[23] FUNC		Switches among Radio, CD changer, MD changer, DVD changer and TV. Turns power on and off. When pressed and held for 1 second: Turns power off.		
[24] BAND DISC UP TOP		Switches reception band.	Moves to the next disc in increasing order.	Switches reception band.
[25] VOLUME		Increases and decreases volume (in all modes).		
[26] SEARCH		Moves preset channels up and down.	Moves tracks up and down. When pressed and held for 1 second: Fast-forward/ Fast-backward.	Moves preset channels up and down.
[27] PLAY/PAUSE		No function.	Switches between playback and pause.	No function.
[28] MUTE		Turns mute on and off.		
[29] ISR		ISR on and off. Press and hold for 2 seconds or longer: Stores current station into ISR memory.		
[30] DISP MONI		Turns on and off the monitor. When pressed and held for 1 second or longer in the DVD changer mode: switches the display size.		
[31] PS/AS SCN		Preset scan. When pressed and held for 2 seconds: Auto store.	Scan play. When pressed and held for 1 second: Disc scan play. (*)	Preset scan. When pressed and held for 2 seconds: Auto store.
[32] WIDE RPT		No function.	Repeat play. When pressed and held for 1 second: Disc repeat play. (*)	Switches TV display size. Switches the VISUAL mode.
[33] TV/VTR RDM		No function.	Random play. When pressed and held for 1 second: Disc random play. (*)	Switches between TV and VTR.
[34] VISUAL		Switches the VISUAL mode. In the DVD changer mode, you can not use this function.		

Notes:

- In the DVD changer mode, the remote control unit can not work for some items.
- Please use the dedicated remote control in the DVD changer mode.

(*) In the DVD changer mode, this remote control unit makes the same operation as that performed using the button with the same name on the remote control unit for the DVD changer.

8. OPERATIONS

Basic Operations

Note: Be sure to read this chapter referring to the front diagrams of chapter "3. CONTROLS" on page 5 (unfold).

⚠ CAUTION

When the unit is turned on, starting and stopping the engine with its volume raised to the maximum level may harm your hearings. Be careful about adjusting the volume.

Note:

- Use this unit after starting the engine.



Turning on and off the power

Note:

• Be careful about using this unit for a long time without running the engine. If you drain the car's battery too far, you may not be able to start the engine and this can reduce the service life of the battery.

1. Press the POWER button [1].
2. The illumination and display on the unit light up. The unit automatically remembers its last operation mode and will automatically switch to display that mode.
3. Press and hold the POWER button [1] for 1 second or longer to turn off the power for the unit.

Note:

• About the "SYSTEM CHECK"

The confirmation of connected equipment must be performed for this unit only when the wiring connection is complete and power is turned on to the unit first. When the power is supplied, "SYSTEM" and "PUSH PWR" appear alternately in the display. Press the POWER button [1], the system check starts inside the unit. When "COMPLETE" appears, press once again the POWER button [1].

Selecting a mode

1. Press the FNC button [1] to change the mode of operation.
2. Each time you press the FNC button [1], the mode of operation changes in the following order:

Radio mode → DAB mode → CD changer mode → MD changer mode → DVD changer mode → TV mode → Radio mode...

* External equipment not connected with CeNET is not selected.

Adjusting the volume

Operate the VOLUME button [2] in the direction of the arrows ▲ (up) or ▼ (down) to adjust the volume;

▲: Increases the volume.

▼: Decreases the volume.

* The volume level indicated in the display is in a range from 0 (minimum) to 33 (maximum).

⚠ CAUTION

While driving, keep the volume at a level at which external sounds can be heard.

Switching the display

When the panel is closed:

Press the DISP button [12] to select the desired display.

Each time you press the DISP button [12], the display switches in the following order:

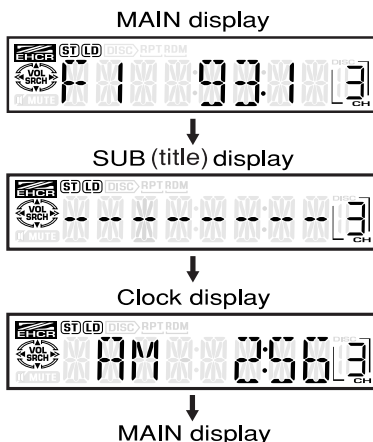

Notes:

• Once selected, the preferred display becomes the default display. When a function adjustment such as volume is made, the display momentarily switches to that function's display, then returns back to the preferred display several seconds after the adjustment.

- If a title has been input, it is shown in the SUB display. If no title has been input, "-----" appears in the display. To input a title, refer to the subsection "Entering titles" in "Other Functions" section.
- For CD, MD and TV, some special characters of the title, will not be displayed on the Information Panel of the DCP. In this case, those characters will only be left blank.

Showing a mode display

When the panel is open:

Press the TITLE button [19] to show the Title List display. In the Title List display, the titles of items stored in the PRESET buttons [13] 1 to 6 are listed.

* For detailed information, refer to the section "Title list play".

Opening and turning the display

Notes:

- Do not place any object on the open display.
 - Do not drop any object on the movable part.
 - Do not expose the display to shocks.
1. Press the OPEN button [11] to open the Color LCD display [16].
 - * If the Color LCD display [16] is left horizontally in the open position for 10 seconds or longer, it is automatically drawn in.
 2. Turn the Color LCD display [16] upwards to a good view angle.

When the monitor is turned upwards, a picture appears in the display. The Information Panel [4] display disappears.

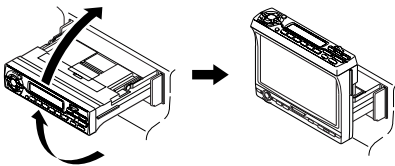

CAUTION

Do not turn the display unless it is completely open.

When adjusting the angle of the display be careful no to let your fingers get caught by the panel or instrument panel of the vehicle.

3. To store the Color LCD display [16] in the source unit, turn it to the horizontal position until a click is heard.

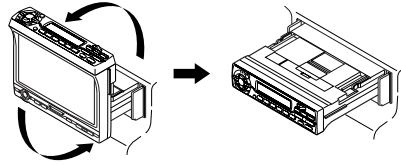

Turning on and off the monitor

Pressing the DISP button [12] turns the monitor on and off.

* When a button is pressed or during security monitoring, the monitor-off mode is canceled.

Mute

Each time you press the MUTE button [14], mute is turned on and off.

"MUTE" appears when mute is turned on.

Setting the Z-enhancer

This unit comes with 3 types of sound tone effect stored in memory. Select the one you prefer.

* The factory default setting is "Z-EHCR OFF".

When a Z-enhancer comes on (1-3), "Z-EHCR" appears in the display.

- "Z-EHCR 1" (Z-Enhancer 1):
Setting emphasizing bass.
- "Z-EHCR 2" (Z-Enhancer 2):
Setting emphasizing treble.
- "Z-EHCR 3" (Z-Enhancer 3):
Setting emphasizing bass and treble.
- "Z-EHCR OFF" (Z-Enhancer off):
Neither bass nor treble are emphasized by the Z-enhancer.

Note:

- Incapable of operation when connecting DSP (DPH910).

When the panel is closed:

Each time you press the Z-EHCR button [9], the tone effect changes in the following order:

“Z-EHCR 1” → “Z-EHCR 2” → “Z-EHCR 3” → “Z-EHCR OFF” → “Z-EHCR 1”...

When the panel is open:

1. Press the A-M button [17] to change into the AUDIO-MODE display.
2. Operate the JOYSTICK [21] upward or downward to select “Z-EHCR”. Press the ENT at the center of the JOYSTICK [21] to change into the Z-enhancer selecting display.
3. Operate the JOYSTICK [21] upward or downward to select out of:
“TYPE 1” (Z-Enhancer 1) ↔ “TYPE 2” (Z-Enhancer 2) ↔ “TYPE 3” (Z-Enhancer 3) ↔ “OFF” (Z-Enhancer off),
and press the ENT at the center of the JOYSTICK [21] to set a desired Z-enhancer.
4. When the setting is finished, operate the JOYSTICK [21] rightward or leftward to move the cursor to the “MENU”. Then press the ENT at the center of the JOYSTICK [21] to return to the AUDIO-MODE display.

* To return from the AUDIO-MODE display to the STANDARD display, press the A-M button [17] once again.

Adjusting the Z-enhancer

Note:

- This function is enabled only when the panel is open.
1. Press the A-M button [17] to change into the AUDIO-MODE display.
 2. Operate the JOYSTICK [21] upward or downward to select “Z-EH LVL” level. Press the ENT at the center of the JOYSTICK [21] to change into the Z-enhancer adjusting display.
 3. Operate the JOYSTICK [21] upward or downward to adjust the Z-enhancer level.
 - * When Z-Enhancer 1 is selected, you can adjust the bass in the range of ± 2 .
 - * When Z-Enhancer 2 is selected, you can adjust the treble in the range of ± 2 .
 - * When Z-Enhancer 3 is selected, you can adjust the bass and treble in the range of ± 2 .
 4. When the adjustment is finished, operate the JOYSTICK [21] rightward or leftward to move the cursor to “MENU”. Then press the ENT at the center of the JOYSTICK [21] to return to the AUDIO-MODE display.

Adjusting the bass and treble

Notes:

- This function is enabled only when the panel is open.
 - This function can be adjusted only when the Z-enhancer is OFF.
1. Press the A-M button [17] to change into the AUDIO-MODE display.
 2. Operate the JOYSTICK [21] upward or downward to select “BAS/TRE”. Then press the ENT at the center of the JOYSTICK [21] to change into the BASS/TREBLE adjusting display.
 3. Operate the JOYSTICK [21] rightward or leftward to adjust the “BASS” or “TREBLE”.
 4. Operate the JOYSTICK [21] upward or downward to adjust a level (adjustment range: from -6 to 6).
 5. When the adjustment is finished, operate the JOYSTICK [21] rightward or leftward to move the cursor to “MENU”. Then press the ENT at the center of the JOYSTICK [21] to return to the AUDIO-MODE display.

Adjusting the balance and fader

Note:

- This function is enabled only when the panel is open.
1. Press the A-M button [17] to change into the AUDIO-MODE display.
 2. Operate the JOYSTICK [21] upward or downward to select “BAL/FAD”. Then press the ENT at the center of the JOYSTICK [21] to change into the BAL/FAD adjusting display.
 3. Operate the JOYSTICK [21] rightward or leftward to select “BALANCE” or “FADER”.
 4. Operate the JOYSTICK [21] upward or downward to make an adjustment.
Adjusting range of the balance: L13 to R13
Adjusting range of the fader: front 12 / rear 12
 5. When the adjustment is finished, operate the JOYSTICK [21] rightward or leftward to move the cursor to “MENU”. Then press the ENT at the center of the JOYSTICK [21] to return to the AUDIO-MODE display.

Turning on/off the loudness

The loudness effect emphasizes the bass and treble to create a natural sound tone. When you are listening to music at a low volume, it is recommended to use the loudness effect.

* This function is enabled only when the panel is open.

1. Press the A-M button **[17]** for 1 second or longer to select Loudness ON. The "LD" indicator lights in the display.
2. Press the A-M button **[17]** for 1 second or longer to select Loudness OFF. The "LD" indicator goes off.

Note:

- When using a sold separately digital sound processor (DPH910), a feature called auto loudness is selected. This function is different from the loudness effect. For further details on the auto loudness feature, refer to the subsection "Output adjustment of auto loudness, subwoofer and playback band".

FM reception

For enhanced FM performance the **MAGI-TUNE**® tuner includes signal actuated stereo control, Enhanced Multi AGC, Impulse noise reduction circuits and Multipath noise reduction circuits.

Changing the reception area

This unit is initially set to USA frequency intervals of 10kHz for AM and 200kHz for FM. When using it outside the USA, the frequency reception range can be switched to the intervals below.

● Setting the reception area

While pressing DISP button **[12]**, each time you press and hold the number "6" of the PRE-SET buttons **[13]** for 2 seconds or longer, the reception area switches from inside the USA to outside the USA or from outside the USA to inside the USA.

* Any station preset memories are lost when the reception area is changed.

Listening to the radio

1. Press the FNC button **[1]** and select the RADIO mode.
2. Press the BND button **[15]** and select the radio band. Each time the button is pressed, the radio reception band changes in the following order:
FM1 → FM2 → FM3 → AM → FM1...
3. Press the right or left side of the SEARCH button **[2]** to tune in the desired station.

Tuning

There are 3 types of tuning mode available, seek tuning, manual tuning and preset tuning.

Seek tuning

1. Press the BND button **[15]** and select the desired band. (FM or AM)
 - * If "MANU" is lit in the display (or when the panel is closed, if the indicator "SRCH" is not lit) press and hold the BND button **[15]** for 1 second or longer. "MANU" in the display goes off (or when the panel is open the indicator "SRCH" lights) and seek tuning is now available.

2. Press the right or left side of SEARCH button [2] to automatically seek a station.

When the right side of SEARCH button [2] is pressed, the station is sought in the direction of higher frequencies; if the left side of SEARCH button [2] is pressed, the station is sought in the direction of lower frequencies.

Manual tuning

There are 2 ways available: Quick tuning and step tuning.

When you are in the step tuning mode, the frequency changes one step at a time. In quick tuning mode, you can quickly tune the desired frequency.

1. Press the BND button [15] and select the desired band. (FM or AM)
 - * If "MANU" is not lit in the display (or when the panel is closed, if the indicator "SRCH" is lit), press and hold the BND button [15] for 1 second or longer. "MANU" appears in the display (or when the panel is closed, the indicator "SRCH" goes off) and manual tuning is now available.
2. Tune into a station.

● Quick tuning:

Press and hold the right or left side of the SEARCH button [2] for 1 second or longer to tune in a station.

● Step tuning:

Press the right or left side of the SEARCH button [2] to manually tune in a station.

Recalling a preset station

A total of 24 preset positions (6-FM1, 6-FM2, 6-FM3, 6-AM) exists to store individual radio stations in memory. Pressing the corresponding PRESET buttons [13] recalls the stored radio frequency automatically.

1. Press the BND buttons [15] and select the desired band. (FM or AM)
2. Press the corresponding Preset buttons [13] to recall the stored station.
 - * Press and hold one of the Preset buttons [13] for 2 seconds or longer to store that station into preset memory.

Manual memory

1. Press the BND button [15] and select the desired band. (FM or AM)
2. Select the desired station with seek tuning, manual tuning, or preset tuning.
3. Press and hold one of the Preset buttons [13] for 2 seconds or longer to store the current station into preset memory.

Auto store

Auto store is a function for storing up to 6 stations that are automatically tuned in sequentially. If 6 receivable stations cannot be received, a previously stored station remains unoverwritten at the memory position.

1. Press the BND button [15] and select the desired band. (FM or AM)
2. Press and hold the PS/AS button 5 for 2 seconds or longer. The stations with good reception are stored automatically to the preset channels.

Preset scan

Preset scan receives the stations stored in preset memory in order. This function is useful when searching for desired station in memory.

1. Press the PS/AS button [5].
2. When the desired station is tuned in, press the PS/AS button [5] again to continue receiving that station.

Note:

- Be careful not to press and hold PS/AS button [5] for 2 seconds or longer, otherwise the auto store function engages and the unit starts storing stations.

Instant station recall (ISR)

Instant station recall is a special radio preset that instantly accesses a favorite radio station at a touch of a button. The ISR function even operates with the unit in other modes.

● ISR memory

1. Select the station that you wish to store in ISR memory.
2. Press and hold ISR button [10] for 2 seconds or longer.

● Recalling a station with ISR

In any mode, press ISR button [10] to turn on the radio function and tune the selected radio station. "ISR" appears in the display. Press ISR button [10] again to return to the previous mode.

CD Changer Operations

CD changer functions

When an optional CD changer is connected through the CeNET cable, this unit controls all CD changer functions. This unit can control a total of 2 changers (MD and/or CD and/or DVD).

Press the FNC button **[1]** and select the CD changer mode to start play. If 2 CD changers are connected, press the FNC button **[1]** to select the CD changer for play.

* If "NO MAG" appears in the display, insert the magazine into the CD changer. "LOADING" appears in the display while the player loads (checks) the magazine.

* If "NO DISC" appears in the display, eject the magazine and insert discs into each slot. Then, reinsert the magazine back into the CD changer.

⚠ CAUTION

CD-ROM discs cannot be played in the CD changer.

Pausing play

1. Press the PLAY/PAUSE button **[3]** to pause play. "PAUSE" appears in the display.
2. To resume play, press the PLAY/PAUSE button **[3]** again.

Displaying CD titles

This unit can display title data for CD-text CDs and user titles input with this unit.

Each time you press and hold the DISP button **[12]** for 1 second or longer, the title display changes in the following order.

When the panel is closed:

User title (disc) → CD-text title (disc) → CD-text title (track) → User title (disc)...

When the panel is open:

User title (disc) → CD-text title (disc & track) → User title (disc)...

Note:

• If the CD playing is not a CD-text CD or no user title has been input, "-----" appears in the display.

● Scrolling a CD-text title

When a CD-text title is longer than 16 characters (8 characters when the panel is closed), you can scroll the display as follows.

When the panel is closed:

1. Display the CD-text title (disc or track).
2. Press and hold the BND button **[15]** for 1 second or longer. The titles scroll.

When the panel is open:

1. Display the CD-text title (disc & track).
2. Press and hold the TITLE button **[19]** for 1 second or longer to scroll the disc title.
3. To scroll the track title, press for 1 second or longer the TITLE button **[19]** within 30 seconds after scrolling the disc title.

Notes:

- If the disc title is shorter than 16 characters, the track titles begin to scroll immediately.
- If the track title is shorter than 16 characters, the track titles does not scroll.

Selecting a CD

Each of the DIRECT buttons **[13]** corresponds to a disc loaded into the magazine.

● Selecting a disc from 1 to 6

Press the corresponding DIRECT button (1 to 6) **[13]** to select the desired disc.

● Selecting a disc from 7 to 12 (only when a 12 disc CD changer is used.)

Press the corresponding DIRECT button (7 to 12) **[13]** for 1 second or more, then select the desired disc.

Selecting a track

● Track-up

1. Press the right side of the SEARCH button **[2]** to move ahead to the beginning of the next track.
2. Each time you press the right side of the SEARCH button **[2]**, the track advances ahead to the beginning of the next track.

● Track-down

1. Press the left side of the SEARCH button **[2]** to move back to the beginning of the current track.
2. Press the left side of the SEARCH button **[2]** twice to move to the beginning of the previous track.

Fast-forward/Fast-backward

● Fast-forward

Press and hold the right side of the SEARCH button **[2]** for 1 second or longer.

● Fast-backward

Press and hold the left side of the SEARCH button **[2]** for 1 second or longer.

Top function

The top function plays from the first track (track No. 1) of the disc.

● When playing a disc 1 to 6

Press the DIRECT button **[13]** (1 to 6) with the same number as the CD playing.

● When playing a disc 7 to 12 (only when a 12 disc CD changer is used.)

Press the DIRECT button **[13]** (7 to 12) with the same number as the CD playing for 1 second or longer.

Scan play

The scan play locates and plays the first 10 seconds of each track on a disc automatically. This function continues on the disc until it is cancelled or the mode is changed.

* The scan play is useful when you want to select a desired track.

1. Press the SCN button **[5]** to start scan play.
2. Press the SCN button **[5]** again to cancel the scan play. Current track continues to play.

Disc scan play

The disc scan play locates and plays the first 10 seconds of the first track on each disc in the currently selected CD changer. This function continues automatically until it is cancelled or the mode is changed.

* The disc scan play is useful when you want to select a desired CD.

1. Press the SCN button **[5]** for 1 second or longer to start disc scan play.
2. Press the SCN button **[5]** again to cancel disc scan play. Normal disc play continues on the current track.

Repeat play

The repeat play continuously plays the current track. This function continues automatically until it is cancelled or the mode is changed.

1. Press the RPT button **[7]**, to make repeat play starts. "RPT" lights in the display.
2. To cancel repeat play, press the RPT button **[7]** again. "RPT" goes off from the display and the unit returns to normal play.

Disc repeat play

After all tracks in the current disc have been played, the disc repeat play automatically replays the current disc over from the first track. This function continues automatically until it is cancelled or the mode is changed.

1. When you press the RPT button **[7]** for 1 second or longer, disc repeat play starts. "D-RPT" lights in the display.
2. To cancel disc repeat play, press the RPT button **[7]** again. "D-RPT" goes off from the display and the unit returns to normal play from the track being played.

Random play

The random play selects and plays individual tracks on the disc in no particular order. This function continues automatically until it is cancelled or the mode is changed.

1. When you press the RDM button **[8]**, random play starts. "RDM" lights in the display.
2. To cancel random play, press the RDM button **[8]** again. "RDM" goes off from the display and the unit returns to normal play.

Disc random play

The disc random play selects and plays individual tracks or discs automatically in no particular order. This function continues automatically until it is cancelled or the mode is changed.

1. When you press the RDM button **[8]** for 1 second or longer, disc random play starts. "D-RDM" lights in the display.
2. To cancel disc random play, press the RDM button **[8]** again. "D-RDM" goes off from the display and the unit returns to normal play from the track being played.

MD Changer Operations

MD changer functions

When an optional MD changer is connected through the CeNET cable, this unit controls all MD changer functions. This unit can control a total of 2 changers (MD and/or CD and/or DVD).

Press the FNC button [1] and select the MD changer mode to start play. If 2 MD changers are connected, press the FNC button [1] to select the MD changer for play.

* If "NO DISC" appears in the display, load MDs into the MD changer.

Pausing play

1. Press the PLAY/PAUSE button [3] to pause play. "PAUSE" appears in the display.
2. To resume play, press the PLAY/PAUSE button [3] again.

Switching disc titles and track titles

This unit can display disc titles and track titles already entered on MDs. Titles up to 128 characters long can be displayed by scrolling the titles.

* Titles cannot be entered for MDs with this unit.

When the panel is closed:

1. Press the DISP button [12] to show the SUB display. The disc title or track title is displayed.
2. Each time you press and hold the DISP button [12] for 1 second or longer, the display toggles between the disc title and the track title.

When the panel is open:

Both disc and track titles are displayed.

Scrolling titles

When a title is longer than 16 characters (or 8 characters if the panel is closed), you can scroll through it with the following operation.

When the panel is closed:

1. Display the MD title (disc or track).
2. Press the BND button [15] for 1 second or longer. The display scrolls through the title.

When the panel is open:

1. Press the TITLE button [19] for 1 second or longer to scroll through the disc title.
2. To scroll the track title, press for 1 second or longer the TITLE button [19] within 30 seconds after scrolling the disc title.

Notes:

- When the disc title is within 16 characters, the title is scrolled immediately.
- If the track title is shorter than 16 characters, the track titles does not scroll.

Selecting an MD

Each of the DIRECT button [13] corresponds to an MD loaded into the MD changer.

Press the DIRECT button [13] (1 to 6) and select the desired MD.

Selecting a track

● Track-up

1. Press the right side of the SEARCH button [2] to move ahead to the beginning of the next track.
2. Each time you press the right side of the SEARCH button [2], the track advances ahead to the beginning of the next track.

● Track-down

1. Press the left side of the SEARCH button [2] to move back to the beginning of the current track.
2. Press the left side of the SEARCH button [2] twice to move to the beginning of the previous track.

Fast-forward/Fast-backward

● Fast-forward

Press and hold the right side of the SEARCH button [2] for 1 second or longer.

● Fast-backward

Press and hold the left side of the SEARCH button [2] for 1 second or longer.

Top function

The top function plays from the first track (track No. 1) of the disc.

Press the DIRECT button [13] (1 to 6) with the same number that the MD playing.

* If an MD is not loaded in a slot of the MD changer, pressing the DIRECT button [13] corresponding to its disc number is invalid.

Scan play

The scan play locates and plays the first 10 seconds of each track on a disc automatically. This function continues on the disc until it is cancelled or the mode is changed.

* The scan play is useful when you want to select a desired track.

1. When you press the SCN button [5], scan play starts.
2. Press the SCN button [5] again to cancel the play. Current track continues to play.

Disc scan play

The disc scan play locates and plays the first 10 seconds of the first track on each disc in the currently selected MD changer. This function continues automatically until it is cancelled or the mode is changed.

* The disc scan play is useful when you want to select a desired MD.

1. When you press the SCN button [5] for 1 second or longer, disc scan play starts.
2. To cancel disc scan play, press the SCN button [5] again. Normal disc play continues on the current track.

Repeat play

The repeat play continuously plays the current track. This function continues automatically until it is cancelled or the mode is changed.

1. When you press the RPT button [7], repeat play starts. "RPT" lights in the display.
2. To cancel repeat play, press the RPT button [7] again. "RPT" goes off from the display and the unit returns to normal play.

Disc repeat play

After all the tracks on the current disc have been played, the disc repeat play automatically replays the current disc over from the first track. This function continues automatically until it is cancelled or the mode is changed.

1. When you press the RPT button [7] for 1 second or longer, disc repeat play starts. "D-RPT" lights in the display.
2. To cancel disc repeat play, press the RPT button [7] again. "D-RPT" goes off from the display and the unit returns to normal play from the track being played.

Random play

The random play selects and plays individual tracks on the disc in no particular order. This function continues automatically until it is cancelled or the mode is changed.

1. When you press the RDM button [8], random play starts. "RDM" lights in the display.
2. To cancel random play, press the RDM button [8] again. "RDM" goes off from the display and the unit returns to normal play.

Disc random play

The disc random play selects and plays individual tracks or discs automatically in no particular order. This function continues automatically until it is cancelled or the mode is changed.

1. When you press the RDM button [8] for 1 second or longer, random play starts. "D-RDM" lights in the display.
2. To cancel random play, press the RDM button [8] again. "D-RDM" goes off from the display and the unit returns to normal play from the track being played.

DVD Changer Operation

DVD changer functions

When an optional DVD changer is connected through the CeNET cable.

In this case, this unit only provides a part of the DVD changer functions. As for other operations not written in this manual, operates with a remote control unit provided with your DVD changer. Refer to the DVD changer owners' manual for details.

This unit can control a total of 2 changers (CD or MD or DVD).

Press the FNC button [1] and select the DVD changer mode to start play.

- * If "NO MAGAZINE" appears in the display, insert the magazine into the DVD changer. "DISC CHECKING" appears in the display while the player loads (checks) the magazine.
- * If "NO DISC" appears in the display, eject the magazine and insert discs into each slot. Then, reinsert the magazine back into the DVD changer.

Pausing Play

1. Press and hold the PLAY/PAUSE button [3] to pause play. "PAUSE" appears in the display.
2. To resume play, press the PLAY/PAUSE button [3] again.
 - * When the panel is open, the same operation is also available by using the PLAY/PAUSE button [3] in the panel.

Slow Play (DVD video & video CD)

1. Press and hold the PLAY/PAUSE button [3] then press and hold the ►► button [2]. While the button is being pressed, slow playback continues at the speed 1/2 times the normal playback.
 - * Slow playback cannot be performed in the backward direction. In addition, audio cannot be reproduced during slow playback.

Selecting a disc

1. Each of the DIRECT buttons [13] corresponds to a disc loaded into the magazine.
2. Press the corresponding DIRECT buttons [13] (1 to 6) to select the desired disc.

Switching to a next disc(Disc Up function)

The disc up function plays from the first track (track No1) of the next disc.

1. Press the BND button [15].
2. Each time you press the BND button [15], the disc changes to the next disc.

Changing over display size

* This function is available only when the panel is open.

Notes:

- This function is not available while you are driving.
- Switch to the VTR/TV/DVD video/DVD changer mode you see.

1. Press the DISP button [12] for 1 second or longer to change over the monitor display size. Each time you press the DISP button [12], the monitor display size changes in the following order:

"NORMAL" → "WIDE" → "F. WIDE" →
"CINEMA" → "NORMAL"

● "NORMAL": (normal display)

There is a black area at both right and left ends of a display. In case of normal TV broadcasting (4:3), the image can be shown without being cut or deformed.

● "WIDE": (wide mode)

The image at right and left ends in a display elongates horizontally.

● "F. WIDE": (full wide mode)

The whole image elongates horizontally.

● "CINEMA": (cinema mode)

The image at both top and bottom in a display disappears.

Notes:

- When a normal 4:3 size image, not being a wide one, is viewed by displaying it fully on a wide monitor display in a wide mode or a full-wide mode, a part of the peripheral image will be lacking or deformed. In deference to the intention of producer, an original image can be viewed in a normal mode.
- During superimposed display, it becomes a full-wide mode.

DVD-Video Operation

Showing the DVD menu

1. Press the TITLE button [19] during playback. The DVD menus appears.

The displayed contents may differ, depending on the DVD software.

- Example showing menu display



Using the title menu

On DVD discs containing two or more titles, you can select from the title menu for playback.

1. Press and hold the TITLE button [19] button for 1 second or longer during playback.

The title menu screen appears.

- Press the TITLE button [19] button, and playback resumes from the scene played back before TITLE button [19] button is pressed.
 - Depending on the disc, the title menu cannot be called.
2. Operate the JOYSTICK [21] upward, downward, leftward or rightward to select an item.
 - Depending on the disc, items cannot be selected with the ten-key buttons on the DVD changer remote control unit.

Skipping a chapter(searching)

About chapter

Chapter means a small segment to divide the data area of the disc.

1. Press the right or left side of the SEARCH button [2] during playback.

Chapters are skipped, as many as the times the button is pressed, and playback starts.

- Press the ► button [2], and playback starts from the beginning of the next chapter.
- Press the ◀ button [2], and playback starts from the beginning of the current chapter.

When this button is pressed again within about 2 seconds, playback starts from the beginning of the previous chapter.

- The unit may return to the menu screen when the right or left side of the SEARCH button [2] is pressed.

Fast forward and fast backward

1. Press and hold the right or left side of the SEARCH button [2] during playback.

Press and hold the button, and the playback speed becomes 4-time faster first and then 16-time faster 3 seconds later. Release the button, and the normal speed is restored.

Notes:

- No audio is reproduced during fast forward and fast rewind operation.
- The fast forward and fast rewind speed may differ depending on the disc.
- The menu screen may appear when the button is pressed.

Scan playback

Scans and plays back all chapters recorded on the DVD-Video, the first 10 seconds for each.

1. Press the SCN button [5].
2. Press the SCN button [5] again and scan playback is turned off.

Chapter repeat playback

This operation plays back chapters recorded on the DVD-Video repeatedly.

1. Press the RPT button [7].
2. Press the RPT button [7] again and repeat playback is turned off.

Title repeat playback

This operation plays back titles recorded on the DVD-Video repeatedly.

1. Press and hold the RPT button [7] for 1 second or longer.
2. Press the RPT button [7] again and repeat playback is turned off.

Watching a video CD

Showing the V-CD menu (for V-CD discs with Play Back Control)

This key does not function on some discs.

1. Press the TITLE button [19] during playback.
The V-CD menu appears.
The displayed contents may differ, depending on the V-CD software.
- Example showing menu display

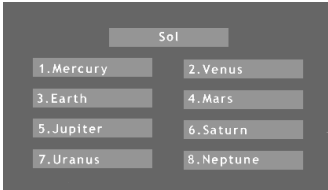

- * To select the menu contents, press the 10 key (DVD changer Remocon) according to the disc contents menu.

Skipping a track (searching)

1. Press the right or left side of the SEARCH button [2] during playback.
The track is skipped, and playback starts.
- Press the ►► button [2], and playback starts from the beginning of the next track.
- Press the ◀◀ button [2], and playback starts from the beginning of the current track.

When this button is pressed again within about 2 seconds, playback starts from the beginning of the previous track.

- * This operation cannot be performed on some discs with PBC

Fast forward and fast backward

1. Press and hold the right or left side of the SEARCH button [2] during playback.
Press and hold the button, and the playback speed becomes 4-time faster first and then 16-time faster 3 seconds later. Release the button, and the normal speed is restored.

Notes:

- No audio is reproduced during fast forward and fast rewind operation.
- The unit may return to the menu screen when the button is pressed.

Scan playback

This operation plays back all tracks on the disc, the first 10 seconds for each.

1. Press the SCN button [5].
2. Press the SCN button [5] again and scan playback is turned off.
 - * If you are playing a disc with PBC and the PBC function is engaged, this operation cannot be performed.

Repeat playback

This operation plays back one track recorded on the video CD repeatedly.

1. Press the RPT button [7].
2. Press the RPT button [7] again and repeat playback is turned off.
 - * If you are playing a disc with PBC and the PBC function is engaged, this operation cannot be performed.

Random playback

This operation plays back all track on the disc in no particular order.

1. Press the RDM button [8].
2. Press the RDM button [8] again and random playback is turned off.
 - * If you are playing a disc with PBC and the PBC function is engaged, this operation cannot be performed.

Listening to a CD

Skipping a track (searching)

1. Press the right or left side of the SEARCH button [2] during playback.
The tracks are skipped, as many as the times the button is pressed, and playback starts.
- Press the ►► button [2], and playback starts from the beginning of the next track.
- Press the ◀◀ button [2], and playback starts from the beginning of the current track.

When this button is pressed again within about 2 seconds, playback starts from the beginning of the previous track.

Fast forward and fast backward

1. Press and hold the right or left side of the SEARCH button [2] during playback.

Press and hold the button, and the playback speed becomes 4-time faster first and then 8-time faster 3 seconds later. Release the button, and the normal speed is restored.

- Press the ◀ button [2], and playback starts from the beginning of the current track.

When this button is pressed again within about 2 seconds, playback starts from the beginning of the previous track.

- * This operation skips the track over the folder.

Scan playback

This operation plays back all tracks on the disc, the first 10 seconds for each.

1. Press the SCN button [5].
2. Press the SCN button [5] again and scan playback is turned off.

Fast forward and fast backward

1. Press and hold the right or left side of the SEARCH button [2] during playback.
Press and hold the button, and the playback speed becomes 4-time faster first and then 8-time faster 3 seconds later. Release the button, and the normal speed is restored.

Track repeat playback

This operation plays back one track recorded on the CD repeatedly.

1. Press the RPT button [7].
2. Press the RPT button [7] again and repeat playback is turned off.

Track scan playback

This operation plays back all files recorded on the disc, about 10 seconds for each.

1. Press the SCN button [5].
2. Press the SCN button [5] again and scan playback is turned off.

Disc repeat playback

This operation plays back all tracks on the disc repeatedly (with music CDs only).

1. Press and hold the RPT button [7] for 1 second or longer.
2. Press the RPT button [7] again and repeat playback is turned off.

Folder scan playback

This operation plays back the first files of all folders on the MP3 disc, about 10 seconds for each.

1. Press and hold the SCN button [5] for 1 second or longer.
2. Press the SCN button [5] again and scan playback is turned off.

Random playback

This operation plays back all track on the disc in no particular order.

1. Press the RDM button [8].
2. Press the RDM button [8] again and random playback is turned off.

Track repeat playback

This operation plays back the file currently being played back repeatedly.

1. Press the RPT button [7].
2. Press the RPT button [7] again and repeat playback is turned off.

Listening to an MP3

Skipping a track (searching)

1. Press the right or left side of the SEARCH button [2] during playback.

The tracks are skipped, as many as the times the button is pressed, and playback starts.

- Press the ▶ button [2], and playback starts from the beginning of the next track.

Folder repeat playback

This operation plays back files in an MP3 folder repeatedly..

1. Press and hold the RPT button [7] for 1 second or longer.
2. Press the RPT button [7] again and repeat playback is turned off.

Track random playback

This operation plays the file in the folder in random order.

1. Press the RDM button [8].
2. Press the RDM button [8] again and random playback is turned off.

Folder random playback

This operation plays back tracks recorded on the disc in no particular order.

1. Press and hold the RDM button [8] for 1 second or longer.
2. Press the RDM button [8] again and random playback is turned off.

Selecting a file (track) on the screen

1. Press the TITLE button [19] during playback. Files (tracks) are displayed.
2. Operate the JOYSTICK [21] upward or downward to select a file, and confirm it by pressing ENT at the center of the JOYSTICK [21].
 - * If no further operation is performed for 7 seconds, the STANDARD screen is returned.

Notes:

- With the panel of the main unit closed, the remote control unit supplied with the DVD changer cannot be operated.
- While the panel of the main unit is closed, "DVD A/C" is shown on the information panel.
- While the car is moving, the panel displays the name of the current mode, time and "AUDIO PROGRAM ONLY".

TV functions

When an optional TV tuner is connected through the CeNET cable, this unit controls all TV tuner functions. To watch TV requires a TV tuner.

WARNING

For your safety, the driver should not watch the TV or operate the controls while driving. Please note that watching and operating the TV while driving are prohibited by law in some countries.

Watching TV

Notes:

- For your safety, the VRX630 has a safety function which turns off the picture when the car is moving, so only the audio can be heard. The picture can only be watched when the car is stopped and the parking break is applied.

1. Press the FNC button [1] and select the TV mode.
2. Press the BND button [15] to select the desired TV band (TV1 or TV2). Each time the button is pressed, the input selection toggles between TV1 and TV2.
3. Press the right or left side of the SEARCH button [2] to tune in the desired TV station.

Watching a video

The TV tuner has a VTR input terminal to which 1 external device can be connected. Connect a 12V video cassette player (VCP) or video cassette recorder (VCR) to the TV tuner input terminal.

1. Press the TV/VTR button [8] and select the VTR.
2. To return to the TV broadcast, press the TV/VTR button [8] again.

Tuning

There are 3 types of tuning mode available, seek tuning, manual tuning and preset tuning.

Seek tuning

1. Press the BND button [15] and select the desired TV band (TV1 or TV2).
 - * If "MANU" is lit in the display (or when the panel is closed, if the indicator "SRCH" is not lit), press and hold the BND button [15] for 1 second or longer. "MANU" in the display goes off (or when the panel is closed, the indicator "SRCH" lights) and seek tuning is now available.
2. Press the right or left side of the SEARCH button [2] to automatically seek a station. Press the right side of the SEARCH button [2] to automatically tune up the frequency band to the next available TV station; press the left side to automatically tune down.

Manual tuning

There are 2 ways available: Quick tuning and step tuning. When you are in the step tuning mode, the frequency changes one step at a time. In quick tuning mode, you can quickly tune the desired frequency.

1. Press the BND button [15] and select the desired band. (TV1 or TV2)
 - * If "MANU" is not lit in the display (or when the panel is closed, if the indicator "SRCH" is lit), press and hold the BND button [15] for 1 second or longer. "MANU" appears in the display (or when the panel is closed, the indicator "SRCH" goes off) and manual tuning is now available.
2. Tune into a station.

● Quick tuning:

Press and hold the right or left side of the SEARCH button [2] for 1 second or longer to tune in a station.

● Step tuning:

Press the right or left side of the SEARCH button [2] to manually tune in a station.

Note:

- Manual tuning is cancelled if you do not operate the unit for 7 seconds longer.

Recalling a preset station

A total of 12 TV stations can be stored (6-TV1 and 6-TV2). This allows you to select your favorite TV stations and store them in memory for later recall.

1. Press the BND button [15] and select the desired TV band. (TV1 or TV2)
2. To recall a stored TV station, press the desired PRESET button [13] to select that station.

- * Press and hold one of the PRESET buttons [13] for 2 seconds or longer to store the current station into the preset memory.

Manual memory

1. Select the desired station with seek tuning, manual tuning or preset tuning.
2. Press and hold one of the PRESET buttons [13] for 2 seconds or longer to store the current station to that preset memory.

Auto store

Auto store selects 6 TV stations automatically and stores each one into a preset memory.

If there are not 6 stations with good reception, stations previously stored in memory remain and only the strong stations are stored into memory.

1. Press the BND button [15] and select the desired TV band. (TV1 or TV2)
2. Press and hold the AS/PS button [5] for 2 seconds or longer. The stations with good reception are automatically stored to the PRESET buttons [13].

Preset scan

Preset scan allows the user to view each preset position before it automatically advances to the next preset. This function is useful for searching for desired TV station in memory.

1. Press the AS/PS button [5].
2. When the desired channel is received, press the AS/PS button [5] again.

Switching the VTR system between NTSC and PAL

* This function is enabled only when the panel is open.

Switch to the VTR or DVD changer mode you use.

1. Press the ADJ button [18] to switch to the adjustment selection display.
2. Operate the JOYSTICK [21] upward or downward to move the cursor to "VTR N/P".
3. Operate the JOYSTICK [21] rightward or leftward to move the cursor to select "NTSC" or "PAL".
4. Press the ENT at the center of the JOYSTICK [21] to set the selected VTR or DVD changer mode.

Setting the TV diver

* This function is enabled only when the panel is open.

* Normally use the TV diver with the "ON" position. You can change the reception setting for the TV antenna connected to the TV tuner.

1. Press the ADJ button [18] to switch to the adjustment selection display.
2. Operate the JOYSTICK [21] upward or downward to select "TV DIVER".
3. Operate the JOYSTICK [21] rightward or leftward to select "ON" or "OFF" and press the ENT at the center of the JOYSTICK [21] to set the selected reception setting.
 - **ON:**
Sets reception emphasizing the visual.
 - **OFF:**
Sets the diver setting to OFF.
4. Press the ADJ button [18] to return to the previous mode.

Adjusting the brightness and tone of color

Notes:

- This operation is available only when the car is stopped and the parking brake is applied.
- This function is not available when the display is stored.
- The HUE setting can be adjusted only when the NTSC mode is selected.

1. Press the BND button [15] to switch to the adjustment selection display.
2. Operate the JOYSTICK [21] upward or downward to select the option "MONI ADJ" (by moving the cursor).
3. Press the ENT at the center of the JOYSTICK [21].
4. Operate the JOYSTICK [21] rightward or leftward to select "BRIGHT", "COLOR" or "HUE" (by moving the cursor).
 - **"BRIGHT":**
Adjust the brightness of the display.
 - **"COLOR":**
Adjusts the color saturation.
 - **"HUE":**
Adjusts the tone of color (red is emphasized or green is emphasized.)
5. Operate the JOYSTICK [21] upward or downward to adjust a level.

6. When the adjustment is made, operate the JOYSTICK [21] rightward or leftward to move the cursor to "MENU". Then press the ENT at the center of the JOYSTICK [21] to return to the adjustment selection display.

Changing over display size

* This function is available only when the panel is open.

Notes:

- This function is not available while you are driving.
- Switch to the VTR/TV/DVD video mode you see.

1. Press the WIDE button [7] to change over the monitor display size. Each time you press the WIDE button [7], the monitor display size changes in the following order:
 "NORMAL" → "WIDE" → "F. WIDE" → "CINEMA" → "NORMAL"
 - **"NORMAL":** (normal display)
There is a black area at both right and left ends of a display. In case of normal TV broadcasting (4:3), the image can be shown without being cut or deformed.
 - **"WIDE":** (wide mode)
The image at right and left ends in a display elongates horizontally.
 - **"F. WIDE":** (full wide mode)
The whole image elongates horizontally.
 - **"CINEMA":** (cinema mode)
The image at both top and bottom in a display disappears.

Notes:

- When a normal 4:3 size image, not being a wide one, is viewed by displaying it fully on a wide monitor display in a wide mode or a full-wide mode, a part of the peripheral image will be lacking or deformed. In deference to the intention of producer, an original image can be viewed in a normal mode.
- During superimposed display, it becomes a full-wide mode.

CCD Camera

Monitoring the CCD camera

The CCD camera can be connected to this unit. For the power supply of the camera, mount the power box sold separately (CCA-188).

Notes:

- This function is not available when the display is stored.
- Refer to the subsection "**Sample System 3**" in "**9. SAMPLE SYSTEMS**" section.

Operation of External Visual Devices (VISUAL Mode)

External visual devices such as DVD and VTR devices can be connected to the DIN 8-pin terminal, and the image and sound can then be played using VISUAL mode.

Notes:

- While driving, the image of the VISUAL Mode is turned OFF and only sound is played.
 - Images can only be played when the vehicle is stationary with the parking brake ON.
1. With the panel open, push VISUAL button **[20]** to switch from radio, TV, CD/MD changer mode to VISUAL mode.
 2. To exit VISUAL Mode and return to the previous mode, press VISUAL button **[20]** again.
 - * The image format played in VISUAL mode can be set to NTSC or PAL format. The setting method is the same as for the TV. Please refer to the TV explanation.
 - * In VISUAL mode, the picture quality can be adjusted. The setting method is the same as for the TV. Please refer to the TV explanation.

Switching to Composite Screen

- * The display panel can be switched to a composite screen to lock the monitor.
1. When the panel is open, press the OPEN/MONI LOCK button **[11]** to switch to the composite screen.
 2. When the panel is open and the composite screen is shown, press the MONI LOCK button **[11]** again to return to the previous screen.

Other Functions

Always turning on the button illumination on the operation panel

Note:

• The following operation is enabled when the panel is open.

The button illumination on the operation panel when the display is turned upward, can be switched between "ON" and "OFF".

- "ON": Button illumination on the operation panel turns on for 5 seconds;
- "OFF" : Button illumination is always on when the power is turned on;

1. When the panel is open, press the ADJ button [18] to show the adjustment selection display.
2. Operate the JOYSTICK [21] upward or downward and select "AUTO ILL" to show "ON" and "OFF" in the menu bar.
3. Operate the JOYSTICK [21] rightward or leftward to select either position to be set and press the ENT at the center of the JOYSTICK [21] for setting.
4. Press the ADJ button [18] to return to the previous mode.
 - * To set "ON" again, switch "OFF" to "ON" manually.

Entering titles

Titles up to 10 characters long can be stored in memory and displayed for Radio stations, TV stations and CDs. The numbers of titles that can be entered for each mode are as follows.

Mode	Number of titles
TUNER mode	30 titles
TV mode	15 titles

CD changer mode	Number of titles
DCZ625 connected	100 titles
CDC655z connected	60 titles
CDC655Tz connected	100 titles
CDC1255z connected	50 titles

* You cannot enter titles with the unit in Seek, Preset Scan, Auto store (TUNER, TV), Scan, Repeat or Random (CD changer, MD changer) mode. Cancel each of those operations before entering titles.

1. Press the FNC button [1] to select the mode you want to enter a title (TUNER, CD changer or TV).
2. Select and play a CD in the CD changer or tune in to a TV station for which you want to enter the title.
3. If you press and hold the TITLE button [19] for 1 second or longer, the display switches to the title input mode display.

4. Operate the JOYSTICK [21] upward or downward, rightward or leftward and move the cursor to the character to be entered. Press the ENT at the center of the JOYSTICK [21].

* When the cursor is at the lower/upper limit of the display, operate the JOYSTICK [21] upward or downward, the character string of the following line appears.

- "-->" : Space
- "<--" : Backspace
- "-|-" : Centering

5. Repeat the step 4 to enter the complete title.
6. Press and hold the ENT at the center of the JOYSTICK [21] for 2 seconds or longer to store the title into memory and cancel title input mode.

Title list play

You can display a list of titles, then select the disc or broadcast station to listen to from that list.

* You can not display a title list with the unit in Seek, Preset Scan, Auto store (Tuner or TV), Scan, Repeat or Random (CD changer or MD changer) mode. Cancel those operation modes before to display a title list.

1. With the unit in radio, CD/MD changer, TV, press the TITLE button [19]. A title list is displayed. The following functions can be carried out in a title list display.
 - **TUNER:** A title of a channel stored in the presets 1 to 6 or a channel number is displayed.
 - **CD/MD changer:** DISC titles for discs 1 to 6 are displayed (By changing over a display page in case of 12-CD changer, disc 7 to 12 can be displayed). When there is not any disc in a changer, "-----" is displayed.
 - **TV:** A title of a channel stored in the presets 1 to 6 or a channel number is displayed.
2. Operate the JOYSTICK [21] upward or downward to select one of the items 1 to 6. Press ENT at the center of the JOYSTICK [21] to reproduce the selected broadcast station or disc.
 - * In case of 12-CD changer, move the cursor to disc 6 and then operate the JOYSTICK [21] downward to change over to a list display of discs 7 to 12.
3. Press the TITLE button [19] again to return to the STANDARD display.

Other Functions

Clock Adjustment

1. Press the ADJ button [18] to display the adjustment selection display.
2. Move the JOYSTICK [21] up or down to select CLOCK, then press ENT at the center of the JOYSTICK [21] to display the clock adjustment display.
3. Move the JOYSTICK [21] left or right to select HR or MIN, then move the JOYSTICK [21] up or down to adjust the time.
* The time is displayed in 12-hour format.
4. Pressing ENT at the center of the JOYSTICK [21] when the cursor is above HR or MIN saves the adjusted value in memory and simultaneously returns the display to the previous display (adjustment selection display).

To cancel clock adjustment before completion, use the JOYSTICK [21] to move the cursor to MENU, then press ENT at the center of the JOYSTICK [21].

Triggered audio mute for cellular telephones

This unit requires special wiring to mute the audio signal automatically when a cellular telephone rings in the car.

- * This function is not compatible with all cellular telephones. Contact your local authorized Clarion dealer for information on proper installation and compatibility.

DSP operations

DSP control function

If the DSP (DPH910), sold separately, is connected to this unit using the CeNET cable, all the functions of the DSP can be controlled.

- * When the DSP is connected, an external amplifier is required.
- * DSP control can all be operated only when the panel is open.

DSP functions

There are 2 modes available in DPH910, standard mode and professional mode. Choose one of them and adjust the sound field and the sound quality.

● Functions common to each mode:

Such as auto loudness, subwoofer etc.

● Standard mode:

Adjustment using the graphic equalizer function and the DSP function.

● Professional mode:

Adjustment using the space equalizer function and the parametric equalizer function.

- * When the standard mode is selected, adjustment for the professional mode cannot be made. On the contrary, when the professional mode is selected, adjustment for the standard mode cannot be made.
- * For details on functions of each mode, refer to the owner's manual supplied with the DPH910.
- * Hereafter the graphic equalizer is referred to as a G.EQ, the space equalizer referred to as VSE and the parametric equalizer referred to as P.EQ.

Operations common to each mode

Output adjustment of auto loudness, subwoofer and playback band

1. Press the ADJ button [18] to switch to the adjustment selection display.
2. Operate the JOYSTICK [21] upward or downward to select "SOUND" and press the ENT at the center of the JOYSTICK [21] to change into the Sound adjustment display. In the Sound adjustment display "A.LD LEVEL", "W.OUT", "W.LPF", "HPF", "T.TONE" are listed.

Operate the JOYSTICK [21] rightward or leftward to select an item to be adjusted.

3. To make an adjustment on:

● **Auto loudness adjustment**

Operate the JOYSTICK [21] upward or downward to adjust an auto loudness level (0 to 10).

● **Woofers out adjustment**

Select woofer output out of “STEREO”, “MONO”, or “OFF”.

Operate the JOYSTICK [21] upward or downward to select a desired item, and then press the ENT at the center of the JOYSTICK [21] to set it.

● **Woofers LPF adjustment**

Select woofer LPF slope out of “50Hz”, “80Hz”, “120Hz”.

Operate the JOYSTICK [21] upward or downward to select a desired item, and then press the ENT at the center of the JOYSTICK [21] to set it.

● **HPF adjustment**

Select HPF slope out of “50Hz”, “80Hz”, “120Hz”, or “OFF”.

Operate the JOYSTICK [21] upward or downward to select a desired item, and then press the ENT at the center of the JOYSTICK [21] to set it.

● **Test Tone Output**

Select Test Tone Output

Operate the JOYSTICK [21] upward or downward to select a desired item, and then press the ENT at the center of the JOYSTICK [21] to produce a test tone.

4. After adjustment (setting), operate the JOYSTICK \downarrow rightward or leftward to move the cursor to “MENU” and press the ENT at the center of the JOYSTICK [21] to return to the adjustment selection display.
5. Press the ADJ button [18] again to return to the STANDARD display.

Selecting the standard mode or the professional mode

* The factory default setting is “STD”.

1. Press the ADJ button [18] to switch to the adjustment selection display.
2. Operate the JOYSTICK [21] upward or downward to select “DSF/EQ”. “STD” and “PRO” items are displayed in the menu bar.
3. Operate the JOYSTICK [21] rightward or leftward to select a desired mode and press the ENT at the center of the JOYSTICK [21] to set the mode thus selected.
4. After setting, press the ADJ button [18] again to return to the STANDARD display.

Woofers level adjustment

You can adjust an output sound level of subwoofer.

1. Press the A-M button [17] to show the AUDIO-MODE display.
2. Operate the JOYSTICK [21] upward or downward to select “W-VOL” and press the ENT at the center of the JOYSTICK [21] to show the woofer level adjusting display.
3. Operate the JOYSTICK [21] upward or downward to adjust the level (0 to 14).
4. After adjustment, operate the JOYSTICK [21] rightward or leftward to select “MENU” and press the ENT at the center of the JOYSTICK [21] return to the AUDIO-MODE display.

Standard mode/Setting the listening position

Selection of listening position

1. Press the A-M button [17] to show the AUDIO-MODE display.
2. Operate the JOYSTICK [21] upward or downward to select “POSITION”. “SELECT” and “DETAIL” are displayed in the menu bar.
3. Operate the JOYSTICK [21] rightward or leftward to select “SELECT”, and press the ENT at the center of the JOYSTICK [21] to show Position selecting display.
4. Operate the JOYSTICK [21] upward or downward and press the ENT at the center of the JOYSTICK [21] to select a desired position.
5. Operate the JOYSTICK [21] rightward or leftward to move the cursor to “MENU”, and press the ENT at the center of the JOYSTICK [21] to return to the AUDIO-MODE display.

Detail adjustment of listening position

1. Press the A-M button [17] to show the AUDIO-MODE display.
2. Operate the JOYSTICK [21] upward or downward to select “POSITION”. “SELECT” and “DETAIL” are displayed in the menu bar.
3. Operate the JOYSTICK [21] rightward or leftward to select “DETAIL”, and press the ENT at the center of the JOYSTICK [21] to show Position Detail adjusting display.

- Operate the JOYSTICK [21] rightward or leftward to select "BALANCE" or "FADER".
- Operate the JOYSTICK [21] upward or downward to make an adjustment.
- Operate the JOYSTICK [21] rightward or leftward to move the cursor to "MENU", and press the ENT at the center of the JOYSTICK [21] to return to the AUDIO-MODE display.

Standard mode/G.EQ operations

Note:

- The adjustment made in standard mode is not reflected in the adjustment in professional mode. Respectively, the adjustment made in professional mode is not reflected in the adjustment in standard mode.

G.EQ effect ON/OFF

* The factory default setting is "ON".

- Press the A-M button [17] to show the AUDIO-MODE display.
- Operate the JOYSTICK [21] upward or downward to select "EQ ON/OFF". "ON" and "OFF" items are displayed in the menu bar.
- Operate the JOYSTICK [21] rightward or leftward to select "ON" or "OFF" and press the ENT at the center of the JOYSTICK [21] to set it.
- After the setting, press the A-M button [17] again to return to the STANDARD display.

Note:

- If the G.EQ effect is set to OFF, the adjustment made in "G.EQ operations" is not reflected in the music source.

Calling G.EQ BASIC Pattern/USER Pattern

- Press the A-M button [17] to show the AUDIO-MODE display.
- Operate the JOYSTICK [21] upward or downward to select "EQ MODE". "BASIC" and "USER" items are displayed in the menu bar.
- Operate the JOYSTICK [21] rightward or leftward to select the item thus called, and press the ENT at the center of the JOYSTICK [21] to show BASIC pattern selecting display or USER pattern selection/memory display.

- In the Pattern selecting display, operate the JOYSTICK [21] rightward or leftward to select P1 to P6, and press the ENT at the center of the JOYSTICK [21] to call corresponding G.EQ pattern. In this display, pressing the No. button in correspondence to the preset button [13] can also call the G.EQ pattern.

* After selecting P1 to P6 by the JOYSTICK [21], press ENT at the center of the JOYSTICK [21] for 2 seconds or longer to copy the selected pattern to the USER pattern.

* Operate the JOYSTICK [21] rightward or leftward to select "EDIT", and press the ENT at the center of the JOYSTICK [21] to show G.EQ adjusting display, in which the properties of currently selected pattern can be adjusted.

* By pressing the BND button [15] in BASIC pattern selecting display or USER pattern selection/memory display you can switch between the two patterns, BASIC and USER.

- Operate the JOYSTICK [21] rightward or leftward to select "MENU", and press the ENT at the center of the JOYSTICK [21] to return to the AUDIO-MODE display.

Setting and storing G.EQ Properties/Memory into USER Pattern

- Repeat the steps 1 to 3 of the previous procedure (Calling G.EQ BASIC Pattern/USER Pattern) to show BASIC pattern selecting display or USER pattern selection/memory display.
- Operate the JOYSTICK [21] leftward and rightward to select "EDIT", and press the ENT at the center of the JOYSTICK [21] to show the G.EQ adjusting display.
- When some frequency to be adjusted is selected by operating the JOYSTICK [21] rightward or leftward in the G.EQ adjusting display, a gain setting value at the selected frequency is displayed.

- Operate the JOYSTICK [21] upward or downward to adjust the G.EQ GAIN.

* By pressing the preset buttons [13] once in the G.EQ adjusting display, the setting value for currently stored USER pattern is obtained.

- After making adjustments to a desired pattern by repeating the operations of items 3 and 4, operate the JOYSTICK [21] rightward or leftward to move the cursor to "RTN", and press the ENT at the center of the JOYSTICK [21] to change over to the BASIC/USER pattern selection/memory display.

6. Operate the JOYSTICK [21] rightward or leftward in the BASIC/USER pattern selection/memory display to select USER memory P1 to P6 to be stored, and press the ENT at the center of the JOYSTICK [21] for 2 seconds or longer to store the adjusted G.EQ pattern to the USER memory.
 - * By pressing the preset button [13] 1 to 6 for 2 seconds or longer in the G.EQ adjusting display, the G.EQ pattern can be stored in the USER memory.
7. To set a title of the stored USER pattern, operate the JOYSTICK [21] rightward or leftward to select "TITLE" and press the ENT at the center of the JOYSTICK [21] to change into the Title Input display.
 - * For title inputting method, refer to the section "Entering titles".
8. Operate the JOYSTICK [21] rightward or leftward to select "MENU" and press the ENT at the center of the JOYSTICK [21] to change into the AUDIO-MODE display.

3. Operate the JOYSTICK [21] rightward or leftward to select the item thus called, and press the ENT at the center of the JOYSTICK [21] to show BASIC pattern selecting display or USER pattern selection/memory display.
4. In the pattern selecting display, operate the JOYSTICK [21] rightward or leftward to select P1 to P6, and press the ENT at the center of the JOYSTICK [21] to call corresponding DSF mode. In this display, pressing the No. button in correspondence to the preset buttons [13] can also call the DSF mode.
 - * After selecting P1 to P6 by operating the JOYSTICK [21], press the ENT at the center of the JOYSTICK [21] for 2 seconds or longer to copy the selected pattern to the USER pattern.
 - * Operate the JOYSTICK [21] rightward or leftward to select "EDIT", and press the ENT at the center of the JOYSTICK [21] to show DSF adjusting display, in which the properties of currently selected pattern can be adjusted.
7. To set a title of the stored USER pattern, operate the JOYSTICK [21] rightward or leftward to select "TITLE" and press the ENT at the center of the JOYSTICK [21] to change into the Title Input display.
 - * For title inputting method, refer to the section "Entering titles".
8. Operate the JOYSTICK [21] rightward or leftward to select "MENU" and press the ENT at the center of the JOYSTICK [21] to change into the AUDIO-MODE display.

Standard mode/DSF operations

DSF effect ON/OFF

- * The factory default setting is "ON".
1. Press the A-M button [17] to show the AUDIO-MODE display.
 2. Operate the JOYSTICK [21] upward or downward to select "DSF ON/OFF". "ON" and "OFF" items are displayed in the menu bar.
 3. Operate the JOYSTICK [21] rightward and leftward to select "ON" or "OFF" and press the ENT at the center of the JOYSTICK [21] to set it.

Note:

- If the DSF effect is set to OFF, the adjustment made in "DSF operations" is not reflected in the music source.

Calling DSF BASIC Pattern/USER Pattern

1. Press the A-M button [17] to show the AUDIO-MODE display.
2. Operate the JOYSTICK [21] upward or downward to select "DSF MODE". "BASIC 1", "BASIC 2" and "USER" items are displayed in the menu bar.

Professional mode/VSE operations

Note:

- The adjustment made in professional mode is not reflected in the adjustment in standard mode. On the contrary, the adjustment made in standard mode is not reflected in the adjustment in professional mode.

VSE effect ON/OFF

- * The factory default setting is "ON".
1. Press the A-M button [17] to show the AUDIO-MODE display.
 2. Operate the JOYSTICK [21] upward or downward to select "VSE ON/OFF". "ON" and "OFF" items are displayed in the menu bar.
 3. Operate the JOYSTICK [21] rightward or leftward to select "ON" or "OFF" and press the ENT at the center of the JOYSTICK [21] to set it.

Note:

- If the VSE effect is set to OFF, the adjustment made in "VSE operations" is not reflected in the music source.

Calling VSE BASIC Pattern/USER Pattern

1. Press the A-M button [17] to show the AUDIO-MODE display.
2. Operate the JOYSTICK [21] upward or downward to select "VSE MODE". "BASIC" and "USER" items are displayed in the menu bar.
3. Operate the JOYSTICK [21] rightward or leftward to select the item thus called, and press the ENT at the center of the JOYSTICK [21] to show BASIC pattern selecting display or USER pattern selection/memory display.
4. In the pattern selecting display, operate the JOYSTICK [21] rightward or leftward to select P1 to P6, and press the ENT at the center of the JOYSTICK [21] to call corresponding VSE pattern. In this display, pressing the No. button in correspondence to the Preset buttons [13] can also call the VSE pattern.
 - * After selecting P1 to P6 by operating the JOYSTICK [21] rightward or leftward, press the ENT at the center of the JOYSTICK [21] for 2 seconds or longer to copy the selected pattern to the USER pattern.
 - * Operate the JOYSTICK [21] rightward or leftward to select "EDIT", and press the ENT at the center of the JOYSTICK [21] to show the VSE adjusting display, in which the properties of currently selected pattern can be adjusted.
 - * By pressing the BND button [15] in BASIC pattern selecting display or USER pattern selection/memory display you can switch between the two patterns, BASIC and USER.
5. Operate the JOYSTICK [21] rightward or leftward to select "MENU", and press the ENT at the center of the JOYSTICK [21] to return to the AUDIO-MODE display.

Setting and storing VSE Properties/Memory into USER Pattern

1. Repeat the steps 1 to 3 of the previous procedure (Calling VSE BASIC Pattern/USER Pattern) to show BASIC pattern selecting display or USER pattern selection/memory display.
2. Operate the JOYSTICK [21] upward or downward to select "VSE EDIT", and press the ENT at the center of the JOYSTICK [21] to show the VSE adjusting display.

3. Select an item to be adjusted by operating the JOYSTICK [21] rightward or leftward in the VSE adjusting display.

"DIFF" → DIFFUSE

"C.WD" → CAR WIDTHH

"C.LG" → CAR LENGTH

4. Operate the JOYSTICK [21] upward or downward to set each adjusting value.
 - * By pressing the preset buttons [13] once in the VSE adjusting display, the setting value for currently stored USER pattern is obtained.
5. After making adjustments to a desired pattern by repeating the steps 3 and 4, operate the JOYSTICK [21] rightward or leftward to move the cursor to "RTN", and press the ENT at the center of the JOYSTICK [21] to change over to the BASIC/USER pattern selection/memory display.
6. Operate the JOYSTICK [21] rightward or leftward in the BASIC/USER pattern selection/memory display to select USER memory P1 to P6 to be stored, and press the ENT at the center of the JOYSTICK [21] for 2 seconds or longer to store the adjusted VSE pattern to the USER memory.
 - * By pressing the preset buttons [13] 1 to 6 for 2 seconds or longer in the VSE adjusting display, the VSE pattern can be stored in the USER memory.
7. To set a title of the stored USER pattern, operate the JOYSTICK [21] rightward or leftward to select "TITLE" and press the ENT at the center of the JOYSTICK [21] to change into the Title Input display.
 - * For title inputting method, refer to the section "Entering titles".
8. Operate the JOYSTICK [21] rightward or leftward to select "MENU" and press the ENT at the center of the JOYSTICK [21] to change into the AUDIO-MODE display.

Professional mode/P.EQ operations

P.EQ effect ON/OFF

- * The factory default setting is "ON".

1. Press the A-M button [17] to show the AUDIO-MODE display.
2. Operate the JOYSTICK [21] upward or downward to select "P.EQ ON/OFF", "ON" and "OFF" items are displayed in the menu bar.

- Operate the JOYSTICK [21] rightward or leftward to select "ON" or "OFF" and press the ENT at the center of the JOYSTICK [21] to set it.

Note:

- If the P.EQ effect is set to OFF, the adjustment made in "P.EQ operations" is not reflected in the music source.

Calling P.EQ BASIC Pattern/USER Pattern

- Press the A-M button [17] to show the AUDIO-MODE display.
- Operate the JOYSTICK [21] upward or downward to select "P.EQ MODE". "BASIC" and "USER" items are displayed in the menu bar.
- Operate the JOYSTICK [21] rightward or leftward to select the item thus called, and press the ENT at the center of the JOYSTICK [21] to show BASIC pattern selecting display or USER pattern selection/memory display.
- In the pattern selecting display, operate the JOYSTICK [21] rightward or leftward to select P1 to P6, and press the ENT at the center of the JOYSTICK [21] to call corresponding P.EQ pattern. In this display, pressing the No. button in correspondence to the Preset buttons [13] can also call the P.EQ pattern.
 - * After selecting P1 to P6 by operating the JOYSTICK [21], press the ENT at the center of the JOYSTICK [21] for 2 seconds or longer to copy the selected pattern to the USER pattern.
 - * Operate the JOYSTICK [21] rightward or leftward to select "EDIT", and press the ENT at the center of the JOYSTICK [21] to show P.EQ adjusting display, in which the properties of currently selected pattern can be adjusted.
 - * By pressing the BND button [15] in BASIC pattern selecting display or USER pattern selection/memory display you can switch between the two patterns, BASIC and USER.
- Operate the JOYSTICK [21] rightward or leftward to select "MENU", and press the ENT at the center of the JOYSTICK [21] to return to the AUDIO-MODE display.

Setting and storing P.EQ Properties/Memory into USER Pattern

- In the Basic adjustment display or in the User setting display, press the A-M button [17] to show the AUDIO-MODE display.
- Operate the JOYSTICK [21] upward or downward to select "EDIT", and press the ENT at the center of the JOYSTICK [21] to show the P.EQ adjusting display.

- Select an item to be adjusted by operating the JOYSTICK [21] rightward or leftward in the P.EQ adjusting display.
- Operate the JOYSTICK [21] upward or downward to set each adjusting value.
 - * By pressing the preset buttons [13] once in the P.EQ adjusting display, the setting value for currently stored USER pattern is obtained.
- After making adjustments to a desired pattern by repeating the operations of items 3 and 4, operate the JOYSTICK [21] rightward or leftward to move the cursor to "RTN", and press the ENT at the center of the JOYSTICK [21] to change over to the BASIC/USER pattern selection/memory display.
- Operate the JOYSTICK [21] rightward or leftward in the BASIC/USER pattern selection/memory display to select USER memory P1 to P6 to be stored, and press the ENT at the center of the JOYSTICK [21] for 2 seconds or longer to store the adjusted P.EQ pattern to the USER memory.
 - * By pressing the preset buttons [13] 1 to 6 for 2 seconds or longer in the P.EQ adjusting display, the P.EQ pattern can be stored in the USER memory.
- To set a title of the stored USER pattern, operate the JOYSTICK [21] rightward or leftward to select "TITLE" and press the ENT at the center of the JOYSTICK [21] to change into the Title Input display.
 - * For title inputting method, refer to the section "Entering titles".
- Operate the JOYSTICK [21] rightward or leftward to select "MENU" and press the ENT at the center of the JOYSTICK [21] to change into the AUDIO-MODE display.

9. IN CASE OF DIFFICULTY

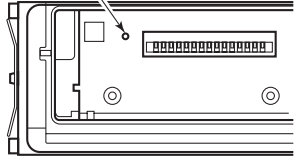
	Problem	Cause	Measure
GENERAL	Power does not turn on. (No sound is produced.)	Fuse is blown.	Replace with a fuse of the same amperage. If the fuse blows again, consult your store of purchase.
		Incorrect wiring.	Consult your store of purchase.
	Nothing happens when buttons are pressed. Display is not accurate.	The microprocessor has malfunctioned due to noise, etc.	Turn off the power, then press the RELEASE lever [6] and remove the DCP. Press the RESET button for about 2 seconds with a thin rod. The Reset button 
		DCP or main unit connectors are dirty.	Wipe the dirt off with a soft cloth moistened with cleaning alcohol.
	The remote controller does not work.	The display is not open.	The remote controller does not work unless the display is open.
		Direct rays of the sun fall on the light-receptive part of the remote controller.	When direct rays of the sun fall on the light-receptive part of the remote controller, it may not work.
The batteries of the remote controller unit are dead or there is no battery in the remote controller unit.		Check the batteries of the remote controller unit.	
TV	The image is not displayed.	The parking brake is not pulled.	Check that the parking brake is applied.
	The display is dark.	The brightness control is too low.	Adjust the brightness properly.
		The operating condition is not good.	The temperature inside the vehicle may be 0°C or less. Set to an appropriate temperature (25°C or so) and check it again.
		The headlight of the vehicle is lit.	The display is made dark at night to prevent the glare (When the headlight of the vehicle is lit in the daytime, the display gets dark).
	The color of the display is light or a shade of color is not good.	The color is not adjusted adequately.	Check that COL and HUE are adjusted properly.
When the VTR is connected, the image is disturbed.	Improper NTSC/PAL setting	Set the NTSC/PAL properly according to the VTR.	

	Problem	Cause	Measure
TV	When the TV tuner is connected, the image gets unclear.	Bad receiving condition	A radio wave may not reach sufficiently due to obstruction of mountains or buildings. Check it again at a place where a radio wave can be received properly.
	The TV tuner has a double or triple image.	Bad receiving condition	It may be under the influence of radio wave reflected by mountains or buildings. Check it again after changing place or direction.
	The TV tuner has spots or stripes in the image.	Presence of jamming	It may be under the influence from automobiles, streetcar, power cable, neon sign, and so forth. Check it again after changing place.
	There are red, green, and blue points in the display.	_____	This is not a failure, but a phenomenon peculiar to a liquid crystal panel (The LCD panel is produced according to technology with very high precision. Note that, though there are effective pixels of 99.99% or more, pixel missing or normally lit pixels account for 0.01%).

10. ERROR DISPLAYS

If an error occurs, one of the following displays is displayed. Take the measures described to eliminate the problem.

	Error Display	Cause	Measure
CD CHANGER	ERROR 2	A CD inside the CD changer is not loaded.	This is a failure of CD changer's mechanism and consult your store of purchase.
	ERROR 3	A CD inside the CD changer cannot be played due to scratches, etc.	Replace with a non-scratched, non-warped-disc.
	ERROR 6	A CD inside the CD changer cannot be played because it is loaded upside-down.	Eject the disc then reload it properly.
MD CHANGER	ERROR H	Displayed when the temperature in the MD changer is too high and playback has been stopped automatically.	Lower the surrounding temperature and wait for a while to cool off MD changer.
	ERROR 2	An MD inside the MD changer is not loaded.	This is a failure of MD changer's mechanism and consult your store of purchase.
	ERROR 3	An MD inside the MD changer cannot be played due to scratches, etc.	Replace with a non-scratched, non-warped-disc.
	ERROR 6	An MD inside the MD changer cannot be played because it is loaded upside-down.	Eject the disc then reload it properly.
Displayed when a non-recorded MD is loaded in the MD changer.		Load a pre-recorded MD in the MD changer.	

For the DVD changer, refer to the Owner's Manual provided with the DVD changer.

If an error display other than the ones described above appears, press the RESET button. If the problem persists, turn off the power and consult your store of purchase.

* When the reset button is pressed, frequencies of TV/radio stations, titles, etc. stored in memory are cleared.

11. SPECIFICATIONS

FM Tuner

Frequency Range: 87.9 MHz to 107.9 MHz
Usable Sensitivity: 11 dBf
50dB Quieting Sensitivity: 17 dBf
Alternate Channel Selectivity: 75 dB
Stereo Separation(1 kHz): 35 dB
Frequency Response(+/-3 dB):
30 Hz to 15 kHz

AM Tuner

Frequency Range: 530 kHz to 1710 kHz
Usable Sensitivity: 25 μ V

Audio Amplifier

Rated power output:
17 W \times 4 (20 Hz to 20 kHz, 1%, 4 Ω)
Maximum power output: 46 W \times 4
Speaker impedance: 4 Ω (4 to 8 Ω)

Input

Video input:
1.0 +/- 0.2 Vp-p (input impedance 75 Ω)

Output

Audio output: min.200mVrms

LCD Monitor

Screen Size:
6.5-inch wide type (142 mm Width \times 78 mm Height)
Display method: Transmission type TN liquid crystal display
Drive method: TFT (thin-film transistor) active matrix driving
Pixels:
280,800 (1200 \times 234)

General

Power source voltage:
14.4 V DC (10.8 to 15.6 V allowable)
Ground:
Negative
Current consumption:
4.0 A (1 W)
Auto Antenna Rated Current:
500 mA less
Dimensions of the Main Unit:
7" (178 mm) Width \times 2" (50 mm) Height \times 6-7/8" (157 mm) Depth
Weight of the Main Unit:
1.7 kg
Dimensions of the Remote Control Unit:
1-3/4" (44 mm) Width \times 4-5/16" (110 mm) Height \times 1-1/16" (27 mm) Depth
Weight of the Remote Control Unit:
30 g (including battery)

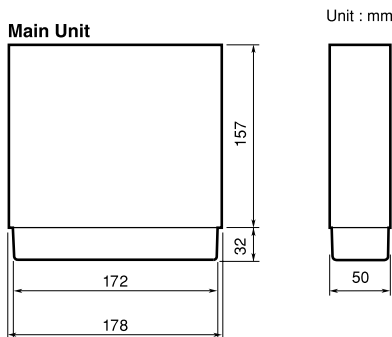

Notes:

- Specifications comply with EIAJ Standards.
- Specifications and design are subject to change without notice for further improvement.

Free Manuals Download Website

<http://myh66.com>

<http://usermanuals.us>

<http://www.somanuals.com>

<http://www.4manuals.cc>

<http://www.manual-lib.com>

<http://www.404manual.com>

<http://www.luxmanual.com>

<http://aubethermostatmanual.com>

Golf course search by state

<http://golfingnear.com>

Email search by domain

<http://emailbydomain.com>

Auto manuals search

<http://auto.somanuals.com>

TV manuals search

<http://tv.somanuals.com>