

Clarion®

Owner's manual
Mode d'emploi
Manual de instrucciones

DXZ555MP

CD/MP3/WMA Receiver / CeNET Control

Récepteur CD/MP3/WMA / Commande CeNET

Reproductor de discos CD/MP3/WMA con receptor y control CeNET

ProAudio

CeNET

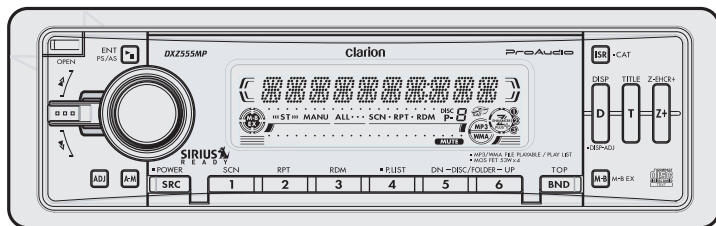

Thank you for purchasing this **Clarion** product.

- * Please read this owner's manual in its entirety before operating this equipment.
- * After reading this manual, be sure to keep it in a handy place (e.g., glove compartment).
- * Check the contents of the enclosed warranty card and keep it carefully with this manual.
- * This manual includes the operating procedures of the CD changer and TV tuner connected via the CeNET cable. The CD changer and TV tuner have their own manuals, but no explanations for operating them are described.

Contents

| | |
|---|----|
| 1. FEATURES | 2 |
| 2. PRECAUTIONS | 3 |
| Flip Down Panel | 4 |
| Handling Compact Discs | 4 |
| 3. CONTROLS | 5 |
| 4. NOMENCLATURE | 6 |
| Names of the Buttons and their Functions | 6 |
| Major button operations when external equipment is connected to this unit | 7 |
| Display Items | 8 |
| LCD Screen | 8 |
| 5. DCP | 9 |
| 6. REMOTE CONTROL | 10 |
| Inserting the Battery | 10 |
| Functions of Remote Control Unit Buttons | 11 |
| 7. OPERATIONS | 12 |
| Basic Operations | 12 |
| Radio Operations | 14 |
| CD/MP3/WMA Operations | 16 |
| Operations Common to Each Mode | 20 |
| 8. OPERATIONS OF ACCESSORIES | 22 |
| CD Changer Operations | 22 |
| TV Operations | 23 |
| 9. IN CASE OF DIFFICULTY | 24 |
| 10. ERROR DISPLAYS | 25 |
| 11. SPECIFICATIONS | 26 |

1. FEATURES

- High Visibility & Contrast Negative Display with Screen Saver
- MP3 and WMA File Playable with ID3-TAG and WMA-TAG Display
- MOS FET 53W X 4 Built in High Power Amplifier
- 4ch RCA output for Flexibility
- AUX Input for External Device
- Z-Enhancer Plus with 2 Band Parametric Equalizer and Magna Bass EX
- Flip-Down Type High Quality Aluminum Faceplate
- Remote Control and DCP Case Included

2. PRECAUTIONS

1. When the inside of the car is very cold and the player is used soon after switching on the heater moisture may form on the disc or the optical parts of the player and proper playback may not be possible. If moisture forms on the disc, wipe it off with a soft cloth. If moisture forms on the optical parts of the player, do not use the player for about one hour. The condensation will disappear naturally allowing normal operation.
2. Driving on extremely bumpy roads which cause severe vibration may cause the sound to skip.
3. This unit uses a precision mechanism. Even in the event that trouble arises, never open the case, disassemble the unit, or lubricate the rotating parts.

This equipment has been tested and found to comply with the limits for a Class B digital device, pursuant to Part 15 of the FCC Rules.

These limits are designed to provide reasonable protection against harmful interference in a residential installation.

This equipment generates, uses, and can radiate radio frequency energy and, if not installed and used in accordance with the instructions, may cause harmful interference to radio communications. However, there is no guarantee that interference will not occur in a particular installation.

If this equipment does cause harmful interference to radio or television reception, which can be determined by turning the equipment off and on, the user is encouraged to consult the dealer or an experienced radio/TV technician for help.

CAUTION
USE OF CONTROLS, ADJUSTMENTS, OR PERFORMANCE OF PROCEDURES OTHER THAN THOSE SPECIFIED HEREIN, MAY RESULT IN HAZARDOUS RADIATION EXPOSURE.

THE COMPACT DISC PLAYER and MINI DISC PLAYER SHOULD NOT BE ADJUSTED OR REPAIRED BY ANYONE EXCEPT PROPERLY QUALIFIED SERVICE PERSONNEL.

CHANGES OR MODIFICATIONS NOT EXPRESSLY APPROVED BY THE MANUFACTURER FOR COMPLIANCE COULD VOID THE USER'S AUTHORITY TO OPERATE THE EQUIPMENT.

INFORMATION FOR USERS:
CHANGES OR MODIFICATIONS TO THIS PRODUCT NOT APPROVED BY THE MANUFACTURER WILL VOID THE WARRANTY AND WILL VIOLATE FCC APPROVAL.

| | |
|---|--------------------------------------|
| MODEL | Clarion |
| 12V \ominus GROUND AM 530-1710kHz/FM 87.9-107.9MHz | |
| THIS DEVICE COMPLIES WITH PART 15 OF THE FCC RULES. OPERATION IS SUBJECT TO THE FOLLOWING TWO CONDITIONS: (1) THIS DEVICE MAY NOT CAUSE HARMFUL INTERFERENCE, AND (2) THIS DEVICE MUST ACCEPT ANY INTERFERENCE RECEIVED, INCLUDING INTERFERENCE THAT MAY CAUSE UNDESIRABLE OPERATION. | |
| THIS PRODUCTION COMPLIES WITH DHHS RULES 21 CFR SUBCHAPTER J APPLICABLE AT DATE OF MANUFACTURE. | |
| CLARION CO., LTD. 50 KAMITODA, TODA-SHI, SAITAMA-KEN, JAPAN | |
| This product includes technology owned by Microsoft Corporation and cannot be used or distributed without a license from MSLGP. | |
| MANUFACTURED: | |
| SERIAL No. PE | 286- Clarion Co., Ltd. MADE IN |

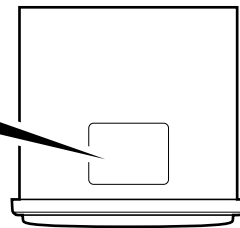

Bottom View of Source Unit

English

Flip Down Panel

This unit uses a flip-down structure that makes possible large-size displays.

CAUTION

When opening and closing the FLIP DOWN PANEL, be careful not to catch your fingers. They could be injured.

1. Always use this unit with the FLIP DOWN PANEL closed.
2. Do not force operations or use this device abnormally when opening or closing the FLIP DOWN PANEL.
3. Do not use the FLIP DOWN PANEL as a tray to place objects on when it is open.

Handling Compact Discs

Use only compact discs bearing the  mark.

Do not play heart-shaped, octagonal, or other specially shaped compact discs.

Some CDs recorded in CD-R/CD-RW mode may not be usable.

Handling

- Compared to ordinary music CDs, CD-R and CD-RW discs are both easily affected by high temperature and humidity and some of CD-R and CD-RW discs may not be played. Therefore, do not leave them for a long time in the car.
- New discs may have some roughness around the edges. If such discs are used, the player may not work or the sound may skip. Use a ball-point pen or the like to remove any roughness from the edge of the disc.
- Never stick labels on the surface of the compact disc or mark the surface with a pencil or pen.
- Never play a compact disc with any cellophane tape or other glue on it or with peeling off marks. If you try to play such a compact disc, you may not be able to get it back out of the CD player or it may damage the CD player.

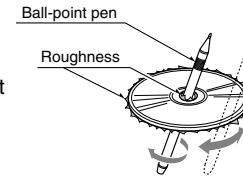

4. When closing the FLIP DOWN PANEL, do not press the [OPEN] button.
5. Strong impacts to the operating or display section can cause damage or deformation.
6. If the FLIP DOWN PANEL does not open fully, gently open it with your hand.

- Do not use compact discs that have large scratches, are misshapen, cracked, etc. Use of such discs may cause misoperation or damage.
- To remove a compact disc from its storage case, press down on the center of the case and lift the disc out, holding it carefully by the edges.
- Do not use commercially available CD protection sheets or discs equipped with stabilizers, etc. These may damage the disc or cause breakdown of the internal mechanism.

Storage

- Do not expose compact discs to direct sunlight or any heat source.
- Do not expose compact discs to excess humidity or dust.
- Do not expose compact discs to direct heat from heaters.

Cleaning

- To remove fingermarks and dust, use a soft cloth and wipe in a straight line from the center of the compact disc to the circumference.
- Do not use any solvents, such as commercially available cleaners, anti-static spray, or thinner to clean compact discs.
- After using special compact disc cleaner, let the compact disc dry off well before playing it.

Be sure to unfold and read the next page. / Veuillez déplier et vous référer à la page suivante.
Cerciórese de desplegar y de leer la página siguiente.

3. CONTROLS / LES COMMANDES / CONTROLES

Source unit / Appareil pilote / Unidad fuente

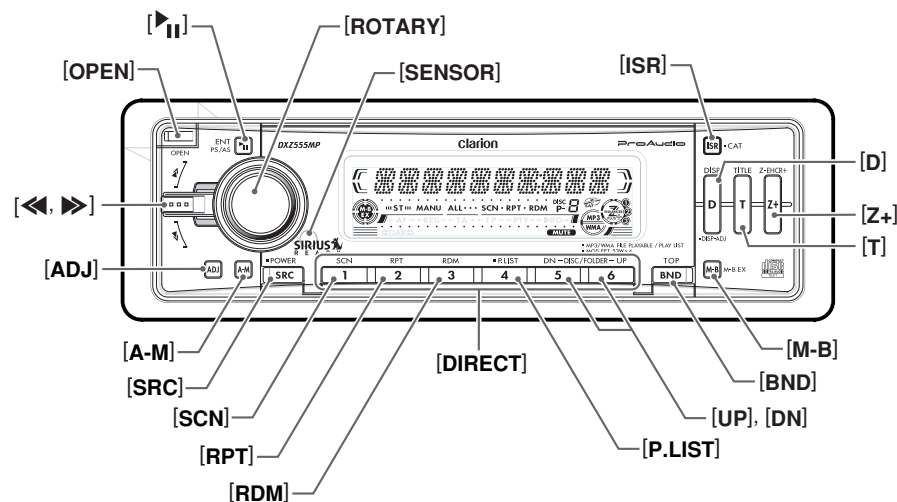

With the FLIP DOWN PANEL opened / Ouvrez le PANNEAU RABATTABLE
Apertura del PANEL ABATIBLE

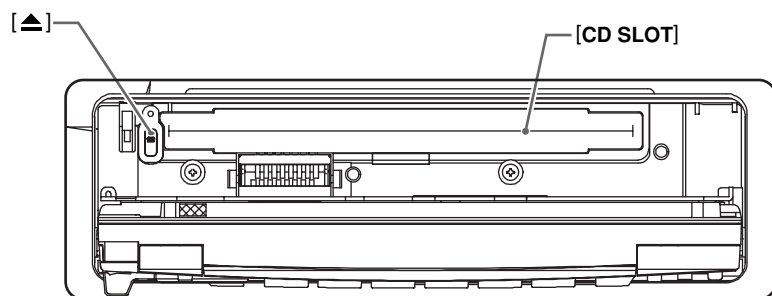

Note: Be sure to unfold this page and refer to the front diagrams as you read each chapter.
Remarque: Veuillez déplier cette page et vous référer aux schémas quand vous lisez chaque chapitre.
Nota: Cuando lea los capítulos, despliegue esta página y consulte los diagramas.

4. NOMENCLATURE

Note:

• Be sure to read this chapter referring to the front diagrams of chapter "3. CONTROLS" on page 5 (unfold).

Names of the Buttons and their Functions

[OPEN] button

- Deeply push in [OPEN] button to unlock the flip down panel.

[▶||] button

- Play or pause a CD while in the CD/MP3/WMA mode.
- Perform preset scan while in the radio mode. When the button is pressed and held, auto store is performed.

[ROTARY] knob

- Adjust the volume by turning the knob clockwise or counterclockwise.
- Use the knob to perform various settings.

[SENSOR]

- Receiver for remote control unit
- Operating range: 30° in all directions

[ISR] button

- Recall ISR radio station in memory.
- Press and hold for 2 seconds or longer: Store current station into ISR memory (radio mode only).

[D] button

- Switch the display indication (Main display, Title display and Clock display).
- Press and hold the button for 1 second or longer to enter the display adjust mode.

[Z+] button

- Use the button to select one of the 3 types of sound characteristics already stored in memory.

[T] button

- Use the button to input a title in the Tuner, CD mode.
- Use the button to switch the user titles or track titles, while in the CD/MP3/WMA mode.
- Use the button to scroll the title during the CD-text play, while in the CD/MP3/WMA mode.

[M-B] button

- Press the button to turn on or off the MAGNA BASS EXTENDED.

[BND] button

- Switch the band, or seek tuning or manual tuning while in the radio mode.
- Play a first track while in the CD/MP3/WMA mode.
- Press the button to change the character.

[UP], [DN] buttons

- Select the Folder. (MP3/WMA disc only)

[P.LIST] button

- Press and hold for 1 second or longer to turn on or off the play list mode. (MP3/WMA disc only)

[DIRECT] buttons

- Store a station into memory or recall it directly while in the radio mode.

[RDM] button

- Perform random play while in the CD/MP3/WMA mode.
- Press and hold the button for 1 second or longer to perform folder random play while in the MP3/WMA mode.

[RPT] button

- Repeat play while in the CD/MP3/WMA mode.
- Press and hold the button for 1 second or longer to perform folder repeat play while in the MP3/WMA mode.

[SCN] button

- Perform scan play for 10 seconds of each track while in the CD/MP3/WMA mode.
- Press and hold the button for 1 second or longer to perform folder scan play while in the MP3/WMA mode.

[SRC] button

- Press the button to turn on the power.
- Press and hold the button for 1 second or longer to turn off the power.
- Switches the operation mode among the radio mode, etc.

[A-M] button

- Use the button to switch to the audio mode (bass/treble, balance/fader Z-Enhancer Plus)

[ADJ] button

- Press the button to enter the adjust mode.

[◀▶] lever

- Select a station while in the radio mode or select a track when listening to a CD. This lever is used to make various settings.
- Press the lever upward or downward and hold in position for 1 second or longer to enter the fast-forward or fast-backward mode.

[▲] button

- Eject a CD/MP3/WMA when it is loaded into the unit.

[CD SLOT]

- CD insertion slot.

Major button operations when external equipment is connected to this unit

● When the CD/DVD changer is connected

- * For details, see the section “CD changer operations”. For the DVD changer, refer to the Owner’s Manual provided with the DVD changer.

[▶||] button

- Play or pause a CD or DVD.

[D] button

- Press the button to display the title.
- Press and hold the button for 1 second or longer to enter the display adjust mode.

[T] button

- Press the button switches the user titles or track titles, etc. while in the CD changer mode.
- Press and hold the button for 1 second or longer to input a title in the CD changer mode.
- Use the button to scroll the title during CD-text play.

[BND] button

- Move the next disc in increasing order.

[UP], [DN] buttons

- Select the disc.

[RDM] button

- Perform random play. Also perform disc random play when the button is pressed and held.

[RPT] button

- Perform repeat play. When this button is pressed and held, disc repeat play is performed.

[SCN] button

- Perform scan play for 10 seconds of each track. Disc scan play is performed when the button is pressed and held.

[◀, ▶] lever

- Select a track when listening to a disc.
- Press the lever upward or downward and hold in position for 1 second or longer to enter the fast-forward or fast-backward mode.

● When the TV is connected

- * For details, see the section “TV operations”.

[▶||] button

- Perform preset scan while in the TV mode. When the button is pressed and held, auto store is performed.

[BND] button

- Switch the band.
- When the button is pressed and held, switch seek tuning or manual mode.

[DIRECT] buttons

- Store a station into memory or recall it directly.

[ADJ] button

- Switch the TV picture mode or VTR (external) picture mode.

[◀, ▶] lever

- Select a station.

● When the Sirius Satellite Radio is connected

- * For details, refer to the Owner’s Manual provided with the Sirius Satellite Radio.

[▶||] button

- Performs category scan while in the SIRIUS mode. When the button is pressed and held, preset scan is performed.

[ISR] button

- Select a category.

[DIRECT] buttons

- Stores a station into memory or recall it directly while in the SIRIUS mode.

[SRC] button

- Press the button to switch the operation mode among the SIRIUS mode, etc.

[◀, ▶] lever

- Select a station.

What is Sirius Satellite Radio? READY

Sirius is radio the way it was meant to be: Up to 100 new channels of digital quality programming delivered to listeners coast to coast via satellite. That means 50 channels of completely commercial-free music. Plus up to 50 more channels of news, sports, and entertainment from names like CNBC, Discovery, SCI-FI Channel, A&E, House of Blues, E!, NPR, Speedvision and ESPN.

Sirius is live, dynamic entertainment, completely focused on listeners. Every minute of every day of every week will be different. All 50 commercial-free music channels are created in-house and hosted by DJs who know and love the music. Do you like Reggae? How about Classic Rock or New Rock? Sirius has an array of choices spanning a vast range of musical tastes including the hits of the 50’s, 60’s, 70’s, & 80’s as well as Jazz, Country, Blues, Pop, Rap, R&B, Bluegrass, Alternative, Classical, Heavy Metal, Dance and many others...

From its state-of-the-art, digital broadcasting facility in Rockefeller Center, New York City, Sirius will deliver the broadest, deepest mix of radio entertainment from coast to coast.

Sirius will bring you music and entertainment programming that is simply not available on traditional radio in any market across the country. It’s radio like you’ve never heard before.

So Get Sirius and Listen Up! For more information, visit siriusradio.com.

Display Items

Operation status indication
Titles, frequency, PS names, clock, etc. are displayed.



Mute indication



: MAGNA BASS EXTEND indication

“ST” : Stereo indication

MANU : Manual indication

ALL... : Folder indication

SCN : Scan indication

RPT : Repeat indication

RDM : Random indication

DISC : Disc indication

P-8 : Preset channel indication (1 to 8)



: Satellite indication



: MP3 indication

: WMA indication



: Z-Enhancer Plus indication

LCD Screen

In extreme cold, the screen movement may slow down and the screen may darken, but this is normal. The screen will recover when it returns to normal temperature.

5. DCP

The control panel can be detached to prevent theft. When detaching the control panel, store it in the DCP (DETACHABLE CONTROL PANEL) case to prevent scratches.

We recommend taking the DCP with you when leaving the car.

Removing the DCP

1. Press the [SRC] button for 1 second or longer to turn off the power.
2. Deeply push in [OPEN] button to unlock the flip down panel.

* If the flip down panel does not open fully, gently open it with your hand.

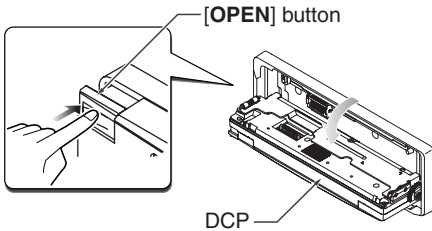

3. Pull the DCP toward you and remove it.

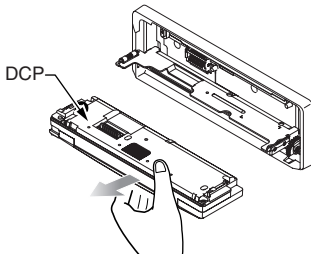

4. Close the HOLD FLAP.

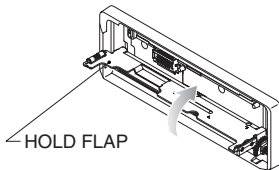

CAUTION

Be sure to close the HOLD FLAP for safety when removing the DCP.

Attaching the DCP

1. Insert the right side of the DCP into the main unit.
2. Insert the left side of the DCP into the main unit.

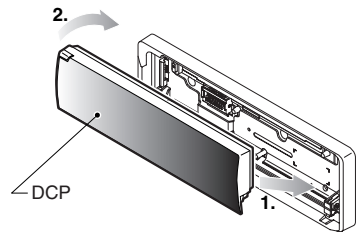

CAUTION

- The DCP can easily be damaged by shocks. After removing it, be careful not to drop it or subject it to strong shocks.
- If the FLIP DOWN PANEL is kept open, the DCP may drop due to vibration of the car. This results in damage to the DCP. So close the FLIP DOWN PANEL or remove the DCP to store into the case.
- The connector connecting the source unit and the DCP is an extremely important part. Be careful not to damage it by pressing on it with fingernails, screwdrivers, etc.

Note:

- If the DCP is dirty, wipe off the dirt with a soft, dry cloth only.

6. REMOTE CONTROL

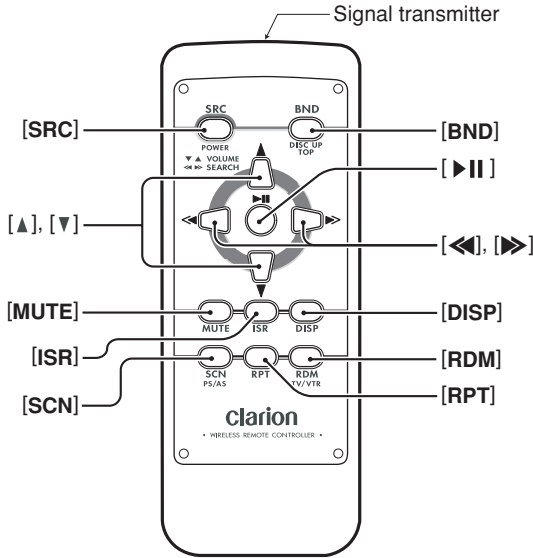

Inserting the Battery

- ① Turn over the remote control unit and slide the cover in the direction indicated by the arrow in the illustration.
- ② Insert the battery (CR2025) into the insertion guides, with the printed side (+) facing upwards.
- ③ Press the battery in the direction indicated by the arrow so that it slides into the compartment.
- ④ Replace the cover and slide in until it clicks into place.

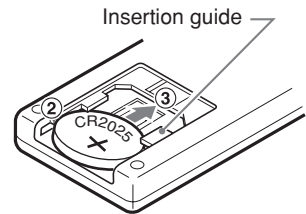
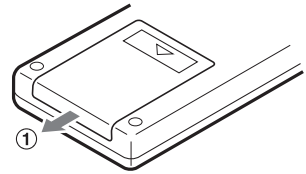

Notes:

Misuse may result in rupture of the battery, producing leakage of fluid and resulting in personal injury or damage to surrounding materials. Always follow these safety precautions:

- Use only the designated battery .
- When replacing the battery, insert properly, with +/- polarities oriented correctly.
- Do not subject battery to heat, or dispose of in fire or water. Do not attempt to disassemble the battery.
- Dispose of used batteries properly.

Functions of Remote Control Unit Buttons

| Mode Button | Radio/SIRIUS | CD/MP3/WMA | CD changer DVD changer | TV |
|----------------|---|---|--|---|
| [SRC] | Switches among radio, SIRIUS tuner, CD/MP3/WMA, CD changer, DVD changer, TV and AUX. | | | |
| [BND] | Switches reception band. | Plays the first track. Top play. | Moves the next disc in increasing order. | Switches reception band. |
| [▲], [▼] | Increases and decreases volume (in all modes). | | | |
| [◀], [▶] | Moves preset channels up and down. | Moves tracks up and down. When pressed and held for 1 second: Fast-forward/fast-backward. | | Moves preset channels up and down. |
| [▶▶] | No function. | Switches between playback and pause. | | No function. |
| [MUTE] | Turns mute on and off. | | | |
| [ISR] | Recalls ISR radio station in memory. Press and hold for 2 seconds or longer: Stores current station into ISR memory (radio mode only). | | | |
| [DISP] | Switches among main display, title display and clock display. | | | |
| [SCN] | Preset scan. When pressed and held for 2 seconds: Auto store. | Scan play. Press and hold the button for 1 second or longer to perform folder scan play while in the MP3/WMA mode. | Scan play. When pressed and held for 1 second: Disc scan play. | Preset scan. When pressed and held for 2 seconds: Auto store. |
| [RPT] | No function. | Repeat play. Press and hold the button for 1 second or longer to perform folder Repeat play while in the MP3/WMA mode. | Repeat play. When pressed and held for 1 second: Disc repeat play. | No function. |
| [RDM] | No function. | Random play. Press and hold the button for 1 second or longer to perform folder Random play while in the MP3/WMA mode. | Random play. When pressed and held for 1 second: Disc random play. | Switches between TV and VTR. |

* Some of the corresponding buttons on the main unit and remote control unit have different functions.

7. OPERATIONS

Basic Operations

Note: Be sure to read this chapter referring to the front diagrams of chapter "3. CONTROLS" on page 5 (unfold).

⚠ CAUTION

Be sure to lower the volume before switching off the unit power or the ignition key. The unit remembers its last volume setting. If you switch the power off with the volume up, when you switch the power back on, the sudden loud volume may hurt your hearing and damage the unit.

Turning on/off the power

Note:

• *Be careful about using this unit for a long time without running the engine. If you drain the car's battery too far, you may not be able to start the engine and this can reduce the service life of the battery.*

1. Press the [SRC] button.
2. The illumination and display on the unit light up. The unit automatically remembers its last operation mode and will automatically switch to display that mode.
3. Press and hold the [SRC] button for 1 second or longer to turn off the power for the unit.

Notes:

• System check

The first time this unit is turned on after the wire connections are completed, it must be checked what equipment is connected. When the power is turned on, the "SYSTEM CHK" appears in the display, then the unit returns to the clock display mode. The system check starts within the unit. When the system check is complete, press the [SRC] button again.

- *If no operation is performed for more than 7 seconds, the audio mode is cancelled and returns to the previous mode.*

Selecting a mode

1. Press the [SRC] button to change the operation mode.
2. Each time you press the [SRC] button, the operation mode changes in the following order:
Radio mode → SIRIUS mode → CD/MP3/WMA mode → CD changer mode → DVD changer mode → TV mode → AUX mode → Radio mode...
* External equipment not connected with CeNET is not displayed.

Adjusting the volume

1. Press the front part of the [ROTARY] knob. The knob will pop up.
2. Turning the [ROTARY] knob clockwise increases the volume; turning it counterclockwise decreases the volume.
* The volume level is from 0 (minimum) to 33 (maximum).

Switching the display

Press the [D] button to select the desired display.

Each time you press the [D] button, the display switches in the following order:

Main display → Title display → Clock display → Main display ...

- * Once selected, the preferred display becomes the display default. When a function adjustment such as volume is made, the screen will momentarily switch to that function's display, then revert back to the preferred display several seconds after the adjustment.
- * When you have entered a title in a CD/MP3/WMA, it appears in the title display. If you have not entered a title, "NO TITLE" appears in the title display instead. For information on how to enter a title, refer to the subsection "Entering titles" in section "Operations Common to Each Mode".

Setting the Z-Enhancer Plus

This unit are provided with 3 types of sound tone effects stored in memory. Select the one you prefer.

- * The factory default setting is "Z+ OFF".

Each time you press the [Z+] button, the tone effect changes in the following order:

"Z+ OFF" → "BASS BOOST" → "IMPACT" → "EXCITE" → "CUSTOM" → "Z+ OFF" ...

- BASS BOOST : bass emphasized
- IMPACT : bass and treble emphasized
- EXCITE : bass and treble emphasized mid de-emphasized
- CUSTOM : user custom
- Z+ OFF : no sound effect

Basic Operations

Adjusting the Z-Enhancer Plus

1. Press the [Z+] button and select the Z-Enhancer Plus mode to adjust.
 2. Press the [A-M] button and turning the [ROTARY] knob clockwise adjusts in the + direction; turning it counterclockwise adjusts in the - direction.
 - When "B-BOOST 0" selected, you can adjust the bass in the range of -3 to 3.
 - When "IMPACT 0" selected, you can adjust the bass and treble in the range of -3 to 3.
 - When "EXCITE 0" selected, you can adjust the bass and treble in the range of -3 to 3.
- * When Z-Enhancer Plus is selected, press and hold the [Z+] button for 1 second or longer to change to the "CUSTOM" mode.
- Bass/treble characteristics become flat and the indication "Z+ FLAT" is shown in the display.

Adjusting the tone

Press the [A-M] button and select the item to adjust. Each time you press the [A-M] button, the item changes as following order:

- When "BASS BOOST" is set
"B-BOOST 0" → "BAL 0" → "FAD 0" → Last function mode.
- When "IMPACT" is set
"IMPACT 0" → "BAL 0" → "FAD 0" → Last function mode.
- When "EXCITE" is set
"EXCITE 0" → "BAL 0" → "FAD 0" → Last function mode.
- When "CUSTOM" is set
"BASS <G 0>" → "TREB <G 0>" → "BAL 0" → "FAD 0" → Last function mode.
- When "Z+ OFF" is set
"BAL 0" → "FAD 0" → Last function mode.

Adjusting the bass (Gain, Frequency, Q-curve)

This adjustment can be performed when the Z-Enhancer Plus is set to "CUSTOM".

1. Press the [A-M] button and select "BASS <G 0>".
2. Turning the [ROTARY] knob clockwise emphasizes the bass; turning it counterclockwise attenuates the bass.
 - * The factory default setting is "BASS <G 0>". (Adjustment range: -6 to +8)

3. Press the [◀, ▶] lever upward or downward to select "BASS <F 50>".
Turn the [ROTARY] knob to select the frequency.
 - * The factory default setting is "BASS <F 50>". (Adjustment 50/80/120 Hz)
4. Press the [◀, ▶] lever upward or downward to select "BASS <Q 1>".
Turn the [ROTARY] knob to select the Q-curve.
 - * The factory default setting is "BASS <Q 1>". (Adjustment 1/1.25/1.5/2)
5. When the adjustment is complete, press the [A-M] button several times until the function mode is reached.

Adjusting the treble (Gain, Frequency)

This adjustment can be performed when the Z-Enhancer Plus is set to "CUSTOM".

1. Press the [A-M] button and select "TREB <G 0>".
2. Turning the [ROTARY] knob clockwise emphasizes the treble; turning it counterclockwise attenuates the treble.
 - * The factory default setting is "TREB <G 0>". (Adjustment range: -6 to +6)
3. Press the [◀, ▶] lever upward or downward to select "TREB <F 12K>".
Turning the [ROTARY] knob to select the frequency.
 - * The factory default setting is "TREB <F 12K>". (Adjustment 8 kHz/12 kHz)
4. When the adjustment is complete, press the [A-M] button several times until the function mode is reached.

Adjusting the balance

1. Press the [A-M] button and select "BAL 0".
2. Turning the [ROTARY] knob clockwise emphasizes the sound from the right speaker; turning it counterclockwise emphasizes the sound from the left speaker.
 - * The factory default setting is "BAL 0". (Adjustment range: L13 to R13)
3. When the adjustment is complete, press the [A-M] button several times until the function mode is reached.

Basic Operations

Adjusting the fader

1. Press the **[A-M]** button and select "FAD 0".
2. Turning the **[ROTARY]** knob clockwise emphasizes the sound from the front speakers; turning it counterclockwise emphasizes the sound from the rear speakers.
 - * The factory default setting is "FAD 0". (Adjustment range: F12 to R12)
3. When the adjustment is complete, press the **[A-M]** button several times until the function mode is reached.

Adjusting MAGNA BASS EXTEND

The MAGNA BASS EXTEND does not adjust the low sound area like the normal sound adjustment function, but emphasizes the deep bass sound area to provide you with a dynamic sound.

- * The factory default setting is off.
1. Press the **[M-B]** button to turn on the MAGNA BASS EXTEND effect. "M-B EX" lights in the display.
 2. Press the **[M-B]** button to turn off the MAGNA BASS EXTEND effect. "M-B EX" goes off from the display.

Radio Operations

Listening to the radio

1. Press the **[SRC]** button and select the radio mode. The frequency appears in the display.
2. Press the **[BND]** button and select the radio band. Each time the button is pressed, the radio reception band changes in the following order:
FM1 → FM2 → FM3 → AM → FM1...
3. Press the **[◀▶]** lever upward or downward to tune in the desired station.

Tuning

There are 3 types of tuning mode available, seek tuning, manual tuning and preset tuning.

Seek tuning

1. Press the **[BND]** button and select the desired band (FM or AM).
 - * If "MANU" is lit in the display, press and hold the **[BND]** button for 1 second or longer. "MANU" in the display goes off and seek tuning is now available.
2. Press the **[◀▶]** lever upward or downward to start automatic station tuning. When the lever is pressed upward, search will be performing in the direction of higher frequencies. When the lever is pressed downward, search will be performed in the direction of lower frequencies.

Manual tuning

There are 2 ways available: Quick tuning and step tuning.

When you are in the step tuning mode, the frequency changes one step at a time. In the quick tuning mode, you can quickly tune the desired frequency.

1. Press the **[BND]** button and select the desired band (FM or AM).
 - * If "MANU" is not lit in the display, press and hold the **[BND]** button for 1 second or longer. "MANU" is lit in the display and manual tuning is now available.
2. Tune into a station.
 - **Quick tuning:**
Press the **[◀▶]** lever upward or downward and hold in position for 1 second or longer to begin station tuning.
 - **Step tuning:**
Press the **[◀▶]** lever upward or downward to perform manual tuning.

Radio Operations

Recalling a preset station

A total of 24 preset positions (6-FM1, 6-FM2, 6-FM3, 6-AM) exists to store individual radio stations in memory. Pressing the corresponding [DIRECT] button recalls the stored radio frequency automatically.

1. Press the [BND] button and select the desired band (FM or AM).
2. Press the corresponding [DIRECT] button to recall the stored station.

* Press and hold one of the [DIRECT] buttons for 2 seconds or longer to store that station into preset memory.

Manual memory

1. Select the desired station with seek tuning, manual tuning or preset tuning.
2. Press and hold one of the [DIRECT] buttons for 2 seconds or longer to store the current station into preset memory.

Auto store

Auto store is a function for storing up to 6 stations that are automatically tuned in sequentially. If 6 receivable stations cannot be received, a previously stored station remains unoverwritten at the memory position.

1. Press the [BND] button and select the desired band (FM or AM).
2. Press and hold the [▶] button for 2 seconds or longer. The stations with good reception are stored automatically to the preset channels.

Preset scan

Preset scan receives the stations stored in preset memory in order. This function is useful when searching for a desired station in memory.

1. Press the [▶] button.
2. When a desired station is tuned in, press the [▶] button again to continue receiving that station.

Note:

- Be careful not to press and hold the [▶] button for 2 seconds or longer, otherwise the auto store function is engaged and the unit starts storing stations.

Instant station recall (ISR)

Instant station recall is a special radio preset that instantly accesses a favorite radio station at a touch of a button. The ISR function even operates with the unit in other modes.

● ISR memory

1. Select the station that you wish to store in ISR memory.
2. Press and hold the [ISR] button for 2 seconds or longer.

● Recalling a station with ISR

In any mode, press the [ISR] button to turn on the radio function and tune the selected radio station. "ISR" appears in the display. Press the [ISR] button again to return to the previous mode.

CD/MP3/WMA Operations

MP3/WMA

What is MP3?

MP3 is an audio compression method and classified into audio layer 3 of MPEG standards. This audio compression method has penetrated into PC users and become a standard format.

This MP3 features the original audio data compression to about 10 percent of its initial size with a high sound quality. This means that about 10 music CDs can be recorded on a CD-R disc or CD-RW disc to allow a long listening time without having to change CDs.

What is WMA?

WMA is the abbreviation of Windows Media Audio, an audio file format developed by Microsoft Corporation.

Notes:

- If you play a file with DRM (Digital Rights Management) for WMA remaining ON, no audio is output.
- Windows Media™, and the Windows ® logo are trademarks, or registered trademarks of Microsoft Corporation in the United States and/or other countries.

● To disable DRM (Digital Rights Management):

1. When using Windows Media Player 8, click on **TOOLS → OPTIONS → COPY MUSIC** tab, then under **COPY SETTINGS**, unclick the check box for **PROTECT CONTENT**. Then, reconstruct files.
2. When using Windows Media Player 9, click on **TOOL → OPTIONS → MUSIC RECORD** tab, then under Recording settings, unclick the Check box for **RECORD PROTECTED MUSIC**. Then, reconstruct files.

Personally constructed WMA files are used at your own responsibility.

Precautions when creating MP3/WMA disc

● Usable sampling rates and bit rates:

1. MP3: Sampling rate 11.025 kHz-48 kHz,
Bit rate: 8 kbps-320 kbps / VBR
2. WMA: Bit rate 48 kbps-192 kbps

● File extensions

1. Always add a file extension **“.MP3”** or **“.WMA”** to MP3 or WMA file by using single byte letters. If you add a file extension other than specified or forget to add the file extension, the file cannot be played.

2. Files without MP3/WMA data will not play. The indication “---:--” appears in the play time display if you attempt to play files without MP3/WMA data.

● Logical format (File system)

1. When writing MP3/WMA file on a CD-R disc or CD-RW disc, please select “ISO9660 level 1, 2 or JOLIET or Romeo” as the writing software format. Normal play may not be possible if the disc is recorded on another format.
2. The folder name and file name can be displayed as the title during MP3/WMA play but the title must be within 128 single byte alphabetical letters and numerals (including an extension).
3. Do not affix a name to a file inside a folder having the same name.

● Folder structure

1. A disc with a folder having more than 8 hierarchical levels will be impossible.

● Number of files or folders

1. Up to 255 files can be recognized per folder. Up to 500 files can be played.
2. Tracks are played in the order that they were recorded onto a disc. (Tracks might not always be played in the order displayed on the PC.)
3. Some noise may occur depending on the type of encoder software used while recording.

Multisession function

When a disc contains both normal CD type tracks and MP3/WMA type tracks mixedly, you can select which type of the recorded tracks to play.

● Default value is “CD”.

Each time you press and hold the **[BND]** button for 1 second or longer, the mixed mode is switched between CD type or MP3/WMA type. The following indication appears in the title display when switching the track type to be played.

● Display when CD type track is selected:

M-SESS CD



● Display when MP3/WMA type track is selected:

M-SESS MP3

1. Types of recording that can be played are as follows.

| Disc | Setting | Set to CD | Set to MP3/WMA |
|---------------------------------------|---------|--------------|----------------|
| Mixed with CD and MP3/WMA type tracks | | Play CD | Play MP3/WMA |
| CD type track only | | Play CD | Play CD |
| MP3/WMA type track only | | Play MP3/WMA | Play MP3/WMA |

- After making these settings, remove the disc and then reinsert it.
- When a mixed mode CD is loaded and CD is set, the track to be played first is MP3/WMA file data and no sound is heard.

Note:

• When playing a CCCC (Copy Control CD), set the setting to CD type. When this is set to MP3/WMA type, the CD cannot be played normally in some cases.

Disc-In-Play function

As long as the ignition key is turned to the ON or ACC position, this function allows you to turn the power to the unit and start playing the disc automatically when the disc is inserted even if the power is not turned on.

⚠ CAUTION

- Do not try to put your hand or fingers in the disc insertion slot. Also never insert foreign objects into the slot.
- Do not insert discs where adhesive comes out from cellophane tape or a rental CD label, or discs with marks where cellophane tape or rental CD labels were removed. It may be impossible to extract these discs from the unit and they may cause the unit to break down.

Backup Eject function

Just pressing the [▲] button ejects the disc even if the power to the unit was not turned on.

- Press the [OPEN] button to open the FLIP DOWN PANEL.

Note:

- If the FLIP DOWN PANEL will not open far enough, open it gently with your hand.
- Press the [▲] button. Remove the disc after it is ejected.
 - Close the FLIP DOWN PANEL.

Note:

• Always close the FLIP DOWN PANEL once you take out the disc.

Listening to a disc already loaded in the unit

Press the [SRC] button to select the CD/MP3/WMA mode.

When the unit enters the CD/MP3/WMA mode, play starts automatically.

If there is no disc loaded, the indication “NO DISC” appears in the title display.



* The mode changes each time the [SRC] button is pressed. (Modes are not displayed for equipment that is not connected.)

Radio → (SIRIUS) → CD/MP3/WMA → (CD changer) → (DVD changer) → (TV) → AUX → Radio...

Loading a CD

- Press the [OPEN] button to access the CD SLOT behind the FLIP DOWN PANEL.
- Insert a CD into the center of the CD SLOT with the labeled side facing up. The CD plays automatically after loading.

Notes:

- Never insert foreign objects into the CD SLOT.
- If the CD is not inserted easily, there may be another CD in the mechanism or the unit may require service.
- Discs not bearing the  or  mark and CD-ROMs cannot be played by this unit.
- Some CDs recorded in CD-R/CD-RW mode may not be usable.

Loading 8 cm compact discs

- * No adapter is required to play an 8 cm CD.
 - * Insert the 8 cm CD into the center of the insertion slot.
- Close the FLIP DOWN PANEL.

⚠ CAUTION

Be careful not to catch your hand or fingers while closing the FLIP DOWN PANEL.

Notes:

- If the FLIP DOWN PANEL does not open fully, gently open with your hand.
- After loading a CD, always close the FLIP DOWN PANEL.

Pausing play

- Press the [⏸] button to pause play. “PAUSE” appears in the display.
- To resume CD play, press the [▶] button again.

CD/MP3/WMA Operations

Displaying CD titles

This unit can display title data for CD-text/MP3/WMA disc and user titles input with this unit.

1. Press the [D] button to display the title.
2. Each time you press the [T] button, the title display changes in the following order:

● CD-TEXT disc

User title (disc) → CD-text title (disc) → Artist name → CD-text title (track) → User title (disc)...

● MP3/WMA disc

Folder → Track → Album TAG → Artist TAG → Title TAG → Folder...

Notes:

- If the CD playing is not a CD-text CD or no user title has been input, "NO TITLE" appears in the display.
- If MP3/WMA disc is not input TAG, "NO TAG" appears in the display.
- For MP3, supports ID3 Tags V2.3 / 2.2 / 1.1 / 1.0.
- Tag displays give priority to V2.3 / 2.2.
- In the case of album Tags for WMA, the information written into the extension header is displayed.
- Only ASCII characters can be displayed in Tags.

Selecting a track

● Track-up

1. Press the [◀, ▶] lever upward to move to the beginning of the next track.
2. Each time the [◀, ▶] lever is pressed upward, playback proceeds to another track in the advancing direction.

● Track-down

1. Press the [◀, ▶] lever downward to move the beginning of the current track.
2. Press the [◀, ▶] lever downward twice to move to the beginning of the previous track.

Fast-forward/fast-backward

● Fast-forward

Press the [◀, ▶] lever upward and hold in position for 1 second or longer.

● Fast-backward

Press the [◀, ▶] lever downward and hold in position for 1 second or longer.

* For MP3/WMA discs, it takes some time until the start of searching and between tracks. In addition, the playing time may have a margin of error.

Folder Select

This function allows you to select a folder containing MP3/WMA files and start playing from the first track in the folder.

1. Press the [DN] or the [UP] button.

Press the [DN] button to move the previous folder. Press the [UP] button to move the next folder.

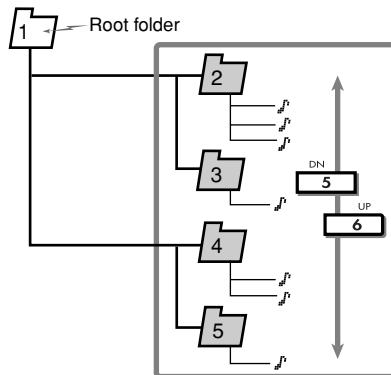

- * Press the [UP] button while in the final folder to shift to the first folder.
- * Folder without an MP3/WMA file is not selectable.

2. To select a track, press the [◀, ▶] lever upward or downward.

Top function

The top function resets the CD player to the first track of the disc. Press the [BND] button to play the first track (track No. 1) on the disc.

* In case of MP3/WMA, the first track of a folder being played will be returned.

Other various play functions

● Scan play

This function allows you to locate and play the first 10 seconds of all the tracks recorded on a disc.

1. Press the [SCN] button to perform scan play.
 - The indication "SCN" lights in the display.
 - * Scan play starts from the next track after the track currently being played.

● Folder scan play

This function allows you to locate and play the first 10 seconds of the first track of all the folders on an MP3/WMA disc.

1. Press and hold the [SCN] button for 1 second or longer to perform folder scan play.

The indications “ALL...” and “SCN” light in the display.

* Folder scan play starts from the next track after the track currently being played.

● Repeat play

This function allows you to play the current track repeatedly.

1. Press the [RPT] button to perform repeat play.
The indication “RPT” lights in the display.

● Folder repeat play

This function allows you to play a track currently being played in the MP3/WMA folder repeatedly.

1. Press and hold the [RPT] button for 1 second or longer to perform folder repeat play.
The indications “ALL...” and “RPT” light in the display.

● Random play

This function allows you to play all tracks recorded on a disc in a random order.

1. Press the [RDM] button to perform random play.
The indication “RDM” lights in the display.

● Folder random play

This function allows you to play all the tracks of all the folders recorded on an MP3/WMA disc in a random order.

1. Press and hold the [RDM] button for 1 second or longer to perform folder random play.
The indications “ALL...” and “RDM” light in the display.

● To cancel play

1. Press the operating button previously selected.

Play list mode

This function allows you to play tracks, up to latest 5 time stamps, by reading the play list information written on the disc.

1. Press and hold the [P.LIST] button for 1 second or longer to turn on or off the play list mode.
 - * Play list play is possible only when there is a file whose extension is “.M3U” on the CD-R/RW.
 - * Up to 5 play lists can be recognized, and up to 255 files can be recognized per play list.
2. Press the [◀, ▶] lever upward or downward to change the track.

3. Press the [DN] button to move to the previous play list.

Press the [UP] button to move to the next play list.

Notes:

- The SCN/RPT/RDM functions cannot be used while in the play list mode.
- The title display changes from folder name to play list name.

Making a play list

1. Write desired tracks to a CD-R/RW, etc. Be sure to use alphanumeric/ASCII characters for all file names.
2. Make a play list by using a multimedia player, etc. and save the data. The file format must be M3U.
3. Again, write this play list to the CD-R/RW, etc.

Notes:

- When writing to a CD-R/RW, etc., be sure to use alphanumeric/ASCII characters.
- Up to 5 layers can be recognized as a list. For written play lists, latest 5 lists are recognized in the order in which they are written.
- When writing to a CD-R/RW, etc., turn off the Disc At Once function.
- When adding a play list, it is recommended to write it in the Root folder.

Operations Common to Each Mode

To change display setting

1. Press and hold the [D] button for 1 second or longer to switch to the adjustment selection display.
2. Press the [◀, ▶] lever upward or downward to select the "item name".
 "CLOCK" ↔ "SCREEN SVR" ↔ "MSG INP" ↔ "AUTO SCROL" ↔ "DIMMER" ↔ "CONTRAST"
3. Turn the [ROTARY] knob to select the "desired setting value".
 - * In the case of item names appearing with the "E" suffix, after the item name, the [▶] button must be pressed to display the setting value.
 - * After completing settings, press the [D] button to return to the previous mode.

● Setting the clock

- 2-1. Select "CLOCK <E>".
- 3-1. Press the [▶] button.
- 3-2. Press the [◀, ▶] lever upward or downward to select the hour or the minute.
- 3-3. Turn the [ROTARY] knob to set the correct time.
 - * The clock is displayed in 12-hour format.
- 3-4. Press the [▶] button to store the time into memory.

Note:

- You cannot set the clock when it is displayed with only the ignition on. If you drain or remove the car's battery or take out this unit, the clock is reset. While setting the clock, if another button or operation is selected, the clock set mode is canceled.

● Turning the screen saver function on or off

This unit is provided with the screen saver function which allows you to show various kinds of patterns and characters in the operation status indication area of the display in a random order. You can turn on and off this function.

If the button operation is performed with the screen saver function on, the operation display corresponding to the button operation is shown for about 30 seconds and the display returns to the screen saver display.

- * The factory default setting is "ON".

- 2-1. Select "SCREEN SVR".
- 3-1. Turn the [ROTARY] knob to select the setting. Each time you turn the [ROTARY] knob, the setting changes in the following order:
 SS OFF → SS ON → SS MESSAGE.

● Entering MESSAGE INFORMATION

Message up to 30 characters long can be stored in memory and displayed as a type of screen saver setting.

- * The factory default setting is "WELCOME TO CLARION".

- 2-1. Select "MSG INP <E>".
- 3-1. Press the [▶] button.
- 3-2. Press and hold [BND] button for 1 second or longer to clear the old message.
- 3-3. Press the [◀, ▶] lever upward or downward to move the cursor.
- 3-4. Press the [BND] button to select a character. Each time you press the [BND] button, the character changes in the following orders:
 Capital letters → Numbers → Symbols → Capital letters...
- 3-5. Turn the [ROTARY] knob to select the desired character.
- 3-6. Repeat step 3-3 to 3-5 to enter up to 30 characters for message.
- 3-7. Press and hold the [▶] button for 2 seconds or longer to store the message in memory and cancel input message mode.
 - * Press and hold the [BND] button for 1 second or longer to cancel the input message. Then press and hold the [▶] button for 2 seconds or longer to store the message and the message return to default setting.

● Setting the method for title scroll

Set how to scroll in CD-TEXT, MP3/WMA title.

- * The factory default setting is "ON".

- 2-1. Select "AUTO SCROL".
- 3-1. Turn the [ROTARY] knob to select "ON" or "OFF".
 - ON:
To scroll automatically.
 - OFF:
To scroll just 1 time when the title was changed or the [T] button was pressed for 1 second or longer.

● Dimmer control

You can setting the dimmer control "ON" or "OFF".

- * The factory default setting is "ON".

- 2-1. Select "DIMMER".
- 3-1. Turn the [ROTARY] knob to select "ON" or "OFF".

Operations Common to Each Mode

● Adjusting the display contrast

You can adjust the display contrast to match the angle of installation of the unit.

* The factory default setting is "5".

2-1. Select "CONTRAST".

3-1. Turn the [ROTARY] knob to select from 1-8.

To change other settings

1. Press the [ADJ] button to switch to the adjustment selection display.

2. Press the [◀, ▶] lever upward or downward to select the "item name".

Each time the [◀, ▶] lever is pressed up/down, the item display changes in the following order:

"BLINK LED" ↔ "AMP CANCEL" ↔ "AUX SENSE" ↔ "SYS CHK"

3. Turn the [ROTARY] knob to select the "desired setting item".

* After completing settings, press the [ADJ] button to return to the previous mode.

● Anti-theft indicator

The red Anti-theft indicator is a function for preventing theft. When the DCP is removed from the unit, this indicator blinks.

* The factory default setting is "OFF".

2-1. Select "BLINK LED".

3-1. Turn the [ROTARY] knob to select "ON" or "OFF".

● Setting the external amplifier

* The factory default setting is "OFF".

2-1. Select "AMP CANCEL".

3-1. Turn the [ROTARY] knob to select "ON" or "OFF".

• ON:

Use with connected AMP.

• OFF:

Use with inside AMP.

● Selecting AUX IN sensitivity

Make the following settings to select the sensitivity when sounds from external devices connected to this unit are difficult to hear even after adjusting the volume.

* The factory default setting is "AUX MID".

2-1. Select "AUX SENSE".

3-1. Turn the [ROTARY] knob to select "AUX LOW", "AUX MID" or "AUX HIGH".

● Performing a system check

This function allows you to perform a system check from the adjust mode when required.

2-1. Select "SYS CHK <E>".

3-1. Press and hold the [▶||] button for 1 second or longer.

"SYSTEM CHK" appears in the display, then the unit returns to the previous operation mode.

Entering titles

Titles up to 10 characters long can be stored in memory and displayed for CD, CD changer and TV stations. The number of titles that can be entered for each mode are as follows.

| Mode | Number of titles |
|------------|------------------|
| CD mode | 50 titles |
| TV mode | 20 titles |
| Tuner mode | 30 titles |

| CD changer mode | Number of titles |
|--------------------|------------------|
| DCZ625 connected | 100 titles |
| CDC655Tz connected | 100 titles |

1. Press the [SRC] button to select the mode you want to enter a title (TUNER, CD, CD changer or TV).

2. Select and play a CD in the CD changer or tune in to a TV station or TUNER for which you want to enter the title.

3. Press the [D] button and display the title display.

4. Press and hold the [T] button for 1 second or longer.

The display switches to the title input display.

5. Press the [◀, ▶] lever upward or downward to move the cursor.

6. Press the [BND] button to select a character. Each time you press the [BND] button, the character changes in the following order:

Capital letters → Numbers → Symbols → Capital letters...

7. Turn the [ROTARY] knob to select the desired character.

8. Repeat steps 5 to 7 to enter up to 10 characters for the title.

9. Press and hold the [▶||] button for 2 seconds or longer to store the title into memory and cancel title input mode.

Operations Common to Each Mode

Clearing titles

1. Select and play a CD in the CD changer or tune in to a TV station or TUNER for which you want to clear the title.
2. Press the [D] button and display the title display.
3. Press and hold the [T] button for 1 second or longer.
The display switches to the title input display.
4. Press and hold the [BND] button for 1 second or longer.
All characters in the title disappear.
5. Press and hold the [▶||] button for 2 seconds or longer to clear the title and cancel title input mode.

Triggered audio mute for cellular telephones

This unit requires special wiring to mute the audio signal automatically when a cellular telephone rings in the car.

- * This function is not compatible with all cellular telephones
Contact your local authorized Clarion dealer for information on proper installation and compatibility.

AUX function

This system has an external input jack so you can listen to sounds and music from external devices connected to this unit.

8. OPERATIONS OF ACCESSORIES

CD Changer Operations

Note:

- The following operations are the same as for CD mode:
 - * **Pause**
 - * **Track selection**
 - * **Fast-forward/fast-backward**
 - * **Scan play**
 - * **Repeat play**
 - * **Random play**
- See "CD/MP3/WMA Operations" (page 17-19) for details.

CD changer functions

When an optional CD changer is connected through the CeNET cable, this unit controls all CD changer functions. This unit can control a total of 2 changers.

Press the [SRC] button and select the CD changer mode to start play. If 2 CD changers are connected, press the [SRC] button to select the CD changer for play.

- * If "NO MAG" appears in the display, insert the magazine into the CD changer. "DISC CHECK" appears in the display while the player loads (checks) the magazine.
- * If "NO DISC" appears in the display, eject the magazine and insert discs into each slot. Then, reinsert the magazine back into the CD changer.

Note:

- Some CDs recorded in CD-R/CD-RW mode may not be usable.

⚠ CAUTION

CD-ROM discs cannot be played from every CD changer, it's depended on the model.

Displaying CD titles

This unit can display title data for CD-text CDs and user titles input with this unit.

- * Title data for CD-text CDs can be displayed with this unit only when it is connected to CDC655Tz.

1. Press the [D] button to display the title.
2. Each time you press the [T] button, the title display changes in the following order:
User title (disc) → CD-text title (disc) → Artist name → CD-text title (track) → User title (disc)...

Notes:

- If the CD playing is not a CD-text CD or no user title has been input, "NO TITLE" appears in the display.
- If a CD-text CD is not input its disc title or a track title, "NO TITLE" appears in the display.

Procedure to scroll a title

Set "SCROLL" to "ON" or "OFF".

(The factory default setting is "ON". Refer to the subsection "Turning the screen saver function on or off" in section "Operation common to each mode".)

● When set to "ON"

The title is automatically kept scrolling.

● When set to "OFF"

To scroll just 1 time when the title was changed or the [T] button was pressed for 1 second or longer.

Selecting a CD

Press the [UP] or [DN] button to select the desired disc.

* If a CD is not loaded in a slot of magazine, pressing the [UP] or [DN] button can not work.

Other various play functions

● Disc scan play

Disc scan play locates and plays the first 10 seconds of the first track on each disc in the currently selected CD changer. This function continues automatically until it is cancelled.

* Disc scan play is useful when you want to select a desired CD.

1. Press and hold the [SCN] button for 1 second or longer. "ALL..." and "SCN" light in the display and disc scan play starts.

● Disc repeat play

After all the tracks on the current disc have been played, disc repeat play automatically replays the current disc over from the first track. This function continues automatically until it is cancelled.

1. Press and hold the [RPT] button for 1 second or longer. "ALL..." and "RPT" light in the display and disc repeat play starts.

● Disc random play

The disc random play selects and plays individual tracks or discs automatically in no particular order. This function continues automatically until it is cancelled.

1. Press and hold the [RDM] button for 1 second or longer. "ALL..." and "RDM" light in the display and disc random play starts.

● To cancel play

1. Press the operating button previously selected.

Note:

• The following operations are performed the same as for radio mode:

- * Channel selection
- * Storing channels in memory
- * Calling channels from memory
- * Auto store
- * Preset scan

See "Radio Operations" (page 14-15) for details.

TV tuner functions

When an optional TV tuner is connected through the CeNET cable, this unit controls all TV tuner functions. To watch TV requires a TV tuner and monitor.

Watching a TV

1. Press the [SRC] button and select the TV mode.
2. Press the [BND] button to select the desired TV band (TV1 or TV2). Each time the button is pressed, the input selection toggles between TV1 and TV2.
3. Press the [◀▶] lever upward or downward to tune in the desired TV station.

Watching a video

The TV tuner has a VTR input terminal to which 1 external device can be connected. Connect a 12 V video cassette player (VCP) or video cassette recorder (VCR) to the TV tuner input terminal.

1. Press and hold the [ADJ] button for 1 second or longer to select VTR.
2. To return to the TV broadcast, press and hold the [ADJ] button for 1 second or longer.

Setting the TV diver

You can change the reception setting for the TV antenna connected to the TV tuner.

1. Press the [ADJ] button to switch to the adjustment selection display.
2. Press the [◀▶] lever upward or downward to select "TV DIVER".
3. Turn the [ROTARY] knob clockwise to set to "ON" or counterclockwise to set to "OFF".

● ON:

Sets the diver setting to ON.

● OFF:

Sets the diver setting to OFF.

4. Press the [ADJ] button to return to the previous mode.

9. IN CASE OF DIFFICULTY

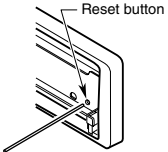
| | Problem | Cause | Measure |
|----------------------------------|--|---|--|
| General | Power does not turn on. (No sound is produced.) | Fuse is blown. | Replace with a fuse of the same amperage. If the fuse blows again, consult your store of purchase. |
| | | Incorrect wiring. | Consult your store of purchase. |
| | No sound output when operating the unit with amplifiers or power antenna attached. | Power antenna lead is shorted to ground or excessive current is required for remote-on the amplifiers or power antenna. | <ol style="list-style-type: none"> 1. Turn the unit off. 2. Remove all wires attached to the power antenna lead. Check each wire for a possible short to ground using an ohm meter. 3. Turn the unit back on. 4. Reconnect each amplifier remote wire to the power antenna lead one by one. If the amplifiers turn off before all wires are attached, use an external relay to provide remote-on voltage (excessive current required). |
| | Nothing happens when buttons are pressed. Display is not accurate. | The microprocessor has malfunctioned due to noise, etc. | Turn off the power, then press the [OPEN] button and remove the DCP. Press the reset button for about 2 seconds with a thin rod.  |
| | | DCP or main unit connectors are dirty. | Wipe the dirt off with a soft cloth moistened with cleaning alcohol. |
| | No sound heard | The speaker protection circuit is operating. | <ol style="list-style-type: none"> 1. Turn down sound volume. Function can also be restored by turning the power off and on again. (Speaker volume is reduced automatically when the speaker protection circuit operates). 2. If the sound is muted again, consult our service department. |
| CD/MP3/WMA | No sound heard | MP3/WMA files are absent in a disc. | Write MP3/WMA files onto the disc properly. |
| | | Files are not recognized as an MP3/WMA file. | Use MP3/WMA files encoded properly. |
| | | File system is not correct. | Use ISO9660 level 1, 2 or JOLIET or Romeo file system. |
| | Sound skips or is noisy. | Compact disc is dirty. | Clean the compact disc with a soft cloth. |
| | | Compact disc is heavily scratched or warped. | Replace with a compact disc with no scratches. |
| | Sound is cut or skipped. Noise is generated or noise is mixed with sound. | MP3/WMA files are not encoded properly. | Use MP3/WMA files encoded properly. |
| | Sound is bad directly after power is turned on. | Water droplets may form on the internal lens when the car is parked in a humid place. | Let dry for about 1 hour with the power on. |
| | Wrong filename | File system is not correct. | Use ISO9660 level 1, 2 or JOLIET or Romeo file system. |
| Play list play is not performed. | File name or extension is not correct. | Use alphanumeric/ASCII characters for MP3/WMA file name. Use “.M3U” for the file extension of a play list. | |

10. ERROR DISPLAYS

If an error occurs, one of the following displays is displayed.
Take the measures described below to eliminate the problem.

| | Error Display | Cause | Measure |
|-------------|----------------|--|---|
| CD/MP3/WMA | ERROR 2 | A CD is caught inside the CD deck and is not ejected. | This is a failure of CD deck's mechanism and consult your store of purchase. |
| | ERROR 3 | A CD cannot be played due to scratches, etc. | Replace with a non-scratched, non-warped-disc. |
| | ERROR 6 | A CD is loaded upside-down inside the CD deck and does not play. | Eject the disc then reload it properly. |
| CD changer | ERROR 2 | A CD inside the CD changer is not loaded. | This is a failure of CD changer's mechanism and consult your store of purchase. |
| | ERROR 3 | A CD inside the CD changer cannot be played due to scratches, etc. | Replace with a non-scratched, non-warped disc. |
| | ERROR 6 | A CD inside the CD changer cannot be played because it is loaded upside-down. | Eject the disc then reload it properly. |
| DVD changer | ERROR 2 | A DISC inside the DVD changer cannot be played. | This is a failure of DVD mechanism and consult your store of purchase. |
| | ERROR 3 | A DISC cannot be played due to scratches, etc. | Retry or replace with a non-scratched, non-warped-disc. |
| | ERROR 6 | A DISC inside the DVD changer cannot be played because it is loaded upside-down. | Eject the disc then reload it properly |
| | ERROR P | Parental level error | Set the correct Parental level. |
| | ERROR R | Region code error | Eject the disc and replace correct region code disc. |

If an error display other than the ones described above appears, press the reset button. If the problem persists, turn off the power and consult your store of purchase.

11. SPECIFICATIONS

FM Tuner

Frequency Range:
87.9 MHz to 107.9 MHz

Usable Sensitivity:
9 dBf

50dB Quieting Sensitivity:
15 dBf

Alternate Channel Selectivity:
70 dB

Stereo Separation (1 kHz):
35 dB

Frequency Response (± 3 dB):
30 Hz to 15 kHz

AM Tuner

Frequency Range:
530 kHz to 1710 kHz

Usable Sensitivity:
25 μ V

CD Player

System:
Compact disc digital audio system

Usable Discs:
Compact disc

Frequency Response (± 1 dB):
5 Hz to 20 kHz

Signal to Noise Ratio (1 kHz):
100 dB

Dynamic Range (1 kHz):
95 dB

Harmonic Distortion:
0.01%

Note:

• Specifications and design are subject to change without notice for further improvement.

Audio

Maximum Power Output:
212 W (53 W \times 4 ch)

Continuous Average Power Output:
18 W \times 4, into 4 Ω , 20 Hz to 20 kHz, 1%THD

Bass Control Action (50 Hz/80 Hz/120 Hz):
+16 dB, -12dB

Treble Control Action (8 kHz/12 kHz):
 ± 12 dB

Line Output Level (CD 1 kHz):
1.8 V

General

Power Supply Voltage:
14.4 V DC (10.8 to 15.6 V allowable), negative ground

Current Consumption:
Less than 15 A, 3A

Speaker Impedance:
4 Ω (4 Ω to 8 Ω allowable)

Weight / Source unit:
2.86 lb. (1.3 kg)

Weight / Remote control unit:
1.41 oz. (40 g) (including battery)

Dimensions / Source unit:
7" (Width) \times 2" (Height) \times 6-3/16" (Depth)
[178 (W) \times 50 (H) \times 157 (D) mm]

Dimensions / Remote control unit:
1-3/4" (Width) \times 4-7/16" (Height) \times 7/16" (Depth)
[44 (W) \times 113 (H) \times 11 (D) mm]

Clarion Co., Ltd.

All Rights Reserved. Copyright © 2004: Clarion Co., Ltd.
Printed in China / Imprimé en Chine / Impreso en China

PE-2719B
280-8143-00

2004/12

Free Manuals Download Website

<http://myh66.com>

<http://usermanuals.us>

<http://www.somanuals.com>

<http://www.4manuals.cc>

<http://www.manual-lib.com>

<http://www.404manual.com>

<http://www.luxmanual.com>

<http://aubethermostatmanual.com>

Golf course search by state

<http://golfingnear.com>

Email search by domain

<http://emailbydomain.com>

Auto manuals search

<http://auto.somanuals.com>

TV manuals search

<http://tv.somanuals.com>