

Clarion

OHM733

OHM833



7" LCD COLOR MONITOR
8" LCD COLOR MONITOR

OWNER'S MANUAL

INTRODUCTION

The Clarion OHM733/OHM833 is a full-featured 7" / 8" LCD Color Monitor that can be used as for a mobile multimedia system.

The OHM733/OHM833 has the following features:

- . TFT Active Matrix Display
- . Swivel Mechanism
- . Adjustable Wide-Screen Format (16:9 / 4:3) (OHM733 only)
- . 2 Audio / Composite video Inputs
- . 1 Audio / Composite video Inputs
- . Lightweight Plastic Housing
- . Built-in Dome Light
- . Built-in IR Transmitter for optional Wireless Headphones
- . Front Panel Control: Power Indicator, Picture Adjust, Aux, FM-Modulator
- . FM Modulator Output Connector (for FM201 Add-On' s)
- . Includes Universal Mounting Bracket
- . Includes IR Remote Control for main Monitor Functions

ABOUT THE MANUAL AND WARRANTY

The start enjoying your new Clarion monitor, please read the instructions listed in the manual. Keep all instructions for future reference. Also, save your original sales receipt as proof of purchase.

TABLE OF CONTENTS:

1. Precautions..... 2

2. Description..... 2

3. Package Contents..... 2

4. Monitor Button Functions..... 3

5. Description of IR Remote Control..... 3

6. Using Remote Control..... 4

7. Inserting the Batteries..... 4

8. Wiring Precautions..... 4

9. Installation Instructions..... 5

10.Dome Light Wiring..... 6

11.Dome Light ON/OFF Switch Description..... 6

12.Din Cable Pin Layout..... 6

13.Picture Adjustments..... 7

14.FM Modulator (FM201) System Diagram..... 7

15.Complete A/V System Diagram..... 8

16.Care and Maintenance..... 9

17.Specification..... 9

1.PRECAUTIONS:

The set is for use in DC 12V, negative ground vehicles.

Do not operate the set in ways other than described in this guide. Doing so may damage it and voids your warranty.

SAFETY FIRST! For rear seat use only. Do not install in dashboard or anywhere else that would permit monitor to be viewed by the driver. Monitor must never be used in any manner that will distract driver or interfere with the driver's safe operation of the motor vehicle.

Be careful not to run down the car battery while using the set with the car stopped.

Do not disassemble or modify the set. Doing so may damage it and voids your warranty.

Keep drinks and drops from umbrellas away from the set. Water may damage the internal circuitry.

Do not let the set become hot. If the temperature in the car is high or the set has been exposed to direct sunlight and is hot, lower the temperature before using it. (The liquid crystal panel will work properly within a temperature range of $-10^{\circ}\text{C} \sim +60^{\circ}\text{C}$ ($14^{\circ}\text{F} \sim 140^{\circ}\text{F}$).

In extremely cold temperatures, the movement of the picture may be slow and the picture may be dark, but this is not a malfunction. The set will work normally once the temperature increases.

Small black and shiny dots inside the liquid crystal panel are normal for liquid crystal product.

2.DESRIPTION

The OHM733/833 is a TFT active matrix color LCD monitor that delivers a striking picture and superior image resolution. The OHM733/833 can be used to enjoy video images with the Clarion video sources.

3.PACKAGE CONTENTS

DESCRIPTION	Q' TY
LCD Monitor	1
Universal Trim Ring	1
IR Remote Control	1
A/V Din Cables	2
FM Modulator Din Cable	1
Power Connector	1
M3X8 Screws	5
Manual/Installation Guide	1
Rubber Gasket	1

4. MONITOR BUTTON FUNCTIONS

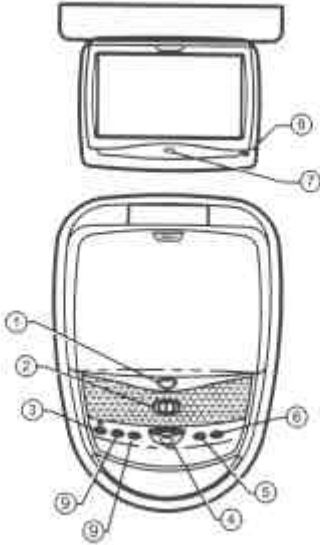

1. **Monitor Release Button**
2. **Dome Light Switch**
3. **Power Button**
4. **Mode Selector**
5. **FM Modulator On/Off Button**
6. **Auxiliary Input Selector**
7. **IR Sensor**
8. **Power LED**
9. **Not Applicable**

5. DESCRIPTION OF IR REMOTE CON

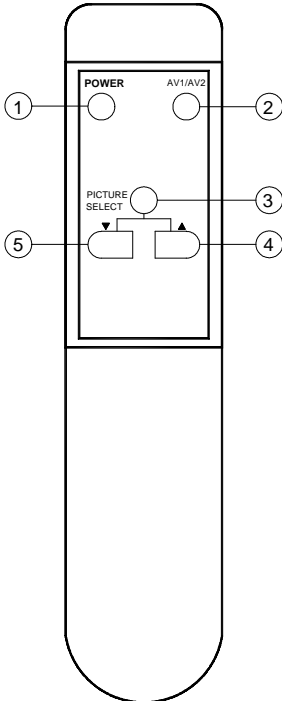

1. **Power Button for Monitor**
Powers on monitor.
2. **Video Button**
Switches between AV1, AV2
3. **Picture Select Button for Monitor**
Goes into picture mode menu for Monitor to select Contrast, Brightness, Color, Tint and Wide Screen Mode.
4. **Picture Mode Up Button**
Adjusts selected picture mode.
5. **Picture Mode Down Button**
Adjusts selected picture mode.

6.USING REMOTE CONTROL

Inside the vehicle, simply aim the IR Remote Control directly at the OHM733/OHM833, or at a Clarion monitor, or video source with an IR eye input and press any desired button for better results. Also note the following:

Aim the IR Remote Control from no further than 2 Meters away and no more than 0.9 Meters on either side of the sensor.

Direct sunlight or very bright light will reduce sensitivity to the IR remote signal commands. Be sure the monitor is not located in direct sunlight.

Objects between the monitor will interfere or block IR remote signal commands.

7.INSERTING THE BATTERIES

1. Locate the battery compartment on the back of the IR Remote Control.
2. Remove the battery holder and insert two AAA alkaline batteries matching polarity as shown inside the battery holder.
3. Snap the battery holder back into the remote unit until it locks with a click.

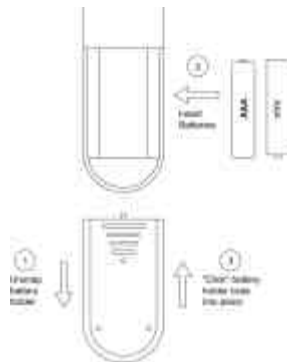

8.WIRING PRECAUTIONS

Read all wiring precautions. If you are not sure of the connections, contact your Authorized Clarion dealer.

1. Disconnect the negative (-) lead of the battery before making any power connections.
2. When creating passage holes for the power wires, use grommets to eliminate any sharp edges created during drilling. This will protect the wire from being nicked and causing a short circuit.
3. When connecting the ground lead, fasten the ground lead (black wire) securely to a clean metal plate on the vehicle.

NOTE: The OHM733/OHM833 monitor displays video images only. It does not provide audio output. Refer to the owner's manual of the connected device for the information on audio output.

9. INSTALLATION INSTRUCTIONS

The OHM733/OHM833 is an overhead, flip-down 7"/8" monitor with an infrared (IR) eye.

It will accept a video signal from any video source with composite video out. The IR eye will work with Clarion video source products with an IR eye input. (Please check first if Adapter is necessary!).

1. Look over the vehicle for a location for the monitor. Each vehicle is different and locations will vary. Make sure the monitor will not interfere with the driver.
2. Run necessary wires to the mounting location. When necessary cut the headliner and pull wires through.
3. Use a 30cm x 30cm x 2cm or 1.2cm thick piece of plywood to mount the OHM733/OHM833.
4. Silicone the piece of plywood to the top of the roof or screw the plywood to the dome light mounting assembly and or the roof support rail.
5. If you don't need full Heights of the universal Trim Ring you can cut these Ring and use than including Rubber gasket to close cutting.
6. Once the plywood has been mounted, connect the IR, power and DIN cables to the designated sources.
7. Make sure all wires and DIN cables are way from screws when drilling.
8. Screw the monitor and universal pod assembly (factory pre-assembled) into the plywood using 4 wood screws (not supplied). Use the shortest screws possible to prevent roof penetration.

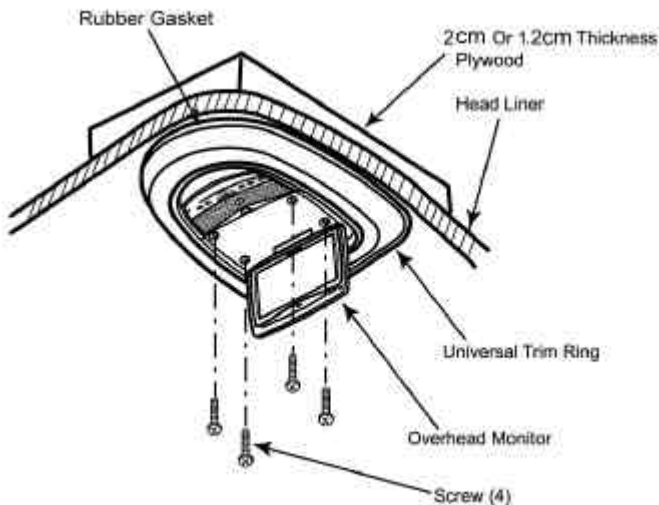

10.DOME LIGHT WIRING

Negative Trigger Door Switch

Brown : +12V

Gray : Ground

White : Door Switch

Positive Trigger Door Switch

Brown : Ground

Gray : +12V

White : Door Switch

11.DOME LIGHT ON/OFF SWITCH DESCRIPTION

A three-position slide switch controls the lights integrated into the OHM733/OHM833 sliding the switch to the ON position will turn the lights on. The OFF position will prevent the lights from turning on at all times and the auto position will allow the lights to turn on and off with the vehicle interior lighting. Do not leave the vehicle unattended with the dome light switch in the ON position, as this could result in a discharged battery.

12.DIN CABLE PIN LAYOUT

Pin	Function
1	AUDIO LEFT INPUT
2	NC
3	AUDIO RIGHT INPUT
4	VIDEO GROUND
5	VIDEO INPUT
6	IR AUDIO L/R GROUND
7	IR OUTPUT
8	NC



Pin	Function
1	NC
2	NC
3	NC
4	NC
5	FM MOD ON/OFF
6	AUDIO LEFT OUTPUT
7	AUDIO L/R GROUND
8	AUDIO RIGHT OUTPUT

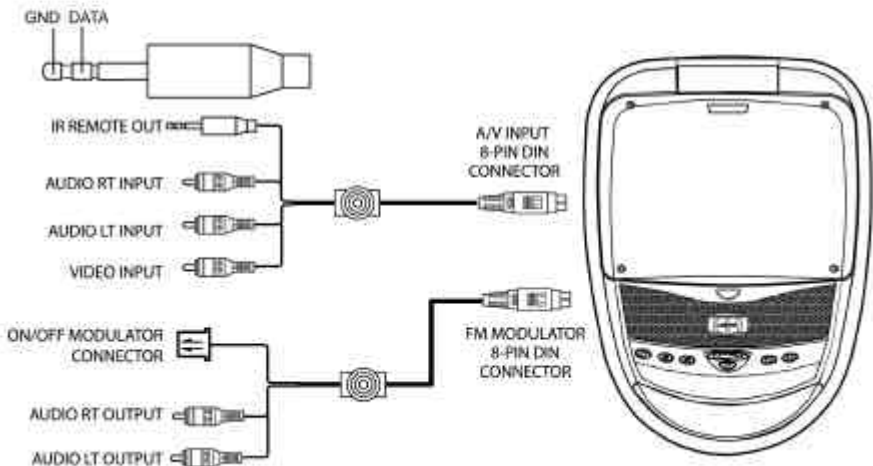
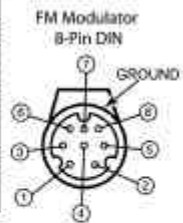

13. PICTURE ADJUSTMENT

To adjust the picture use the mode button to select the mode feature you would like to Adjust. Adjustment selections are as follow:

- Contrast
- Brightness
- Color
- Wide screen ON/OFF (OHM733 only)
- Tint

Press the up button to increase and the down button to decrease.

14. FM MODULATOR (FM201) SYSTEM DIAGRAM

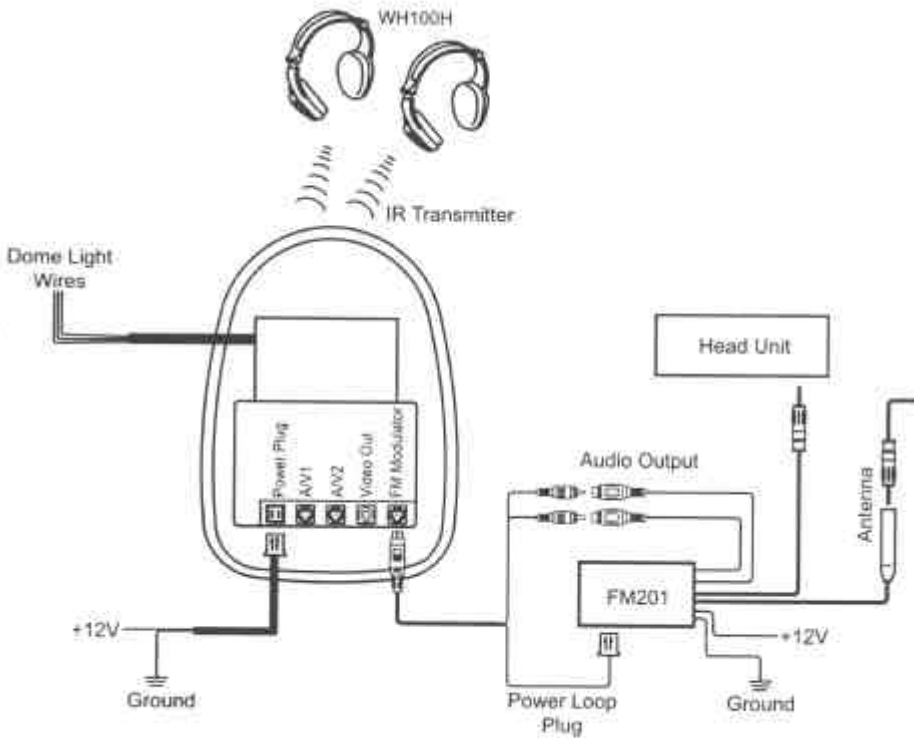

15. COMPLETE A/V SYSTEM DIAGRAM

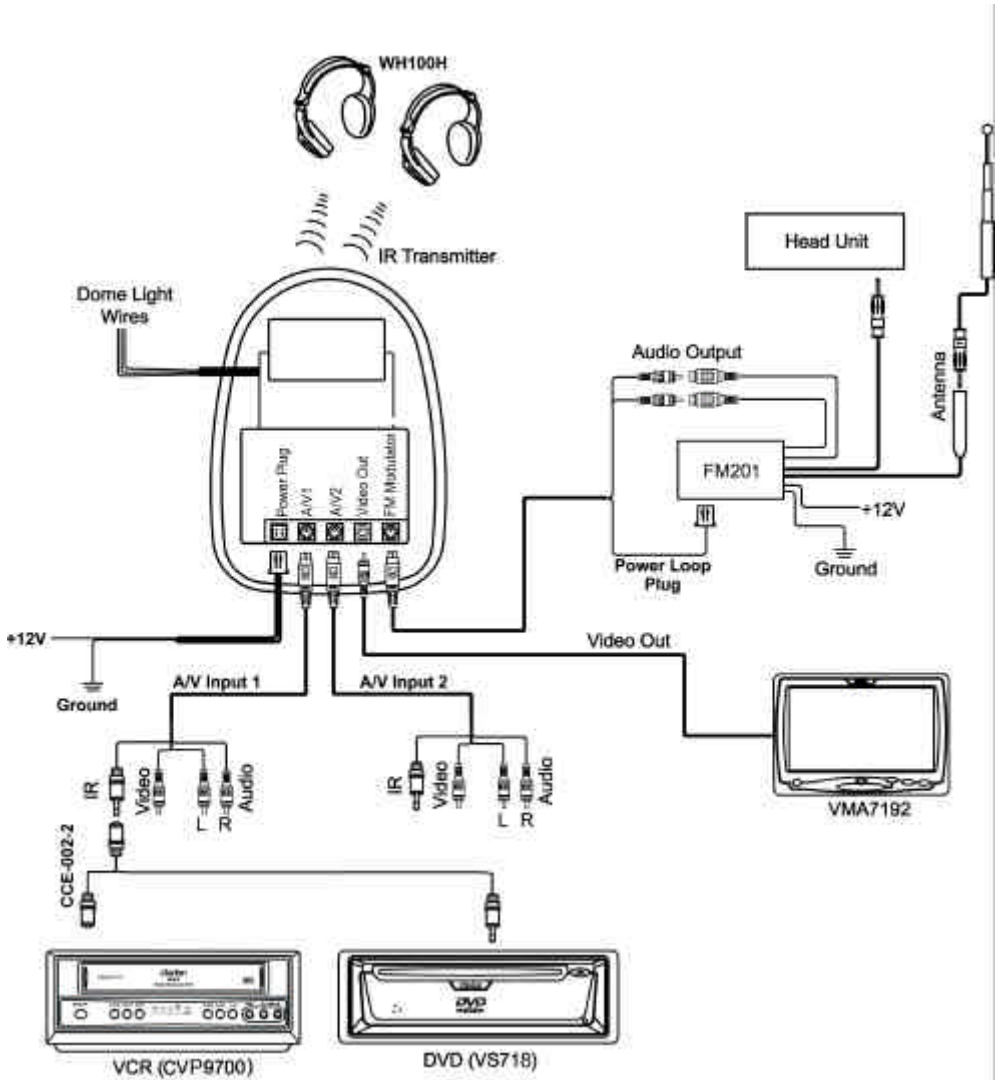

16. CARE AND MAINTENANCE

Cleaning the cabinet

Use a soft, dry cloth to gently wipe off any dirt.

Do not use benzene, thinner, car cleaner, etc., as these substances may damage the cabinet or cause the paint to peel.

Cleaning the LCD panel

Use a soft, dry cloth to gently wipe off any dust.

The surface is easily scratched; do not rub it with hard objects.

17. SPECIFICATIONS

GENERAL SPECIFICATIONS:

Power Source:	Car Battery (DC 9-16V)
Power Consumption:	DC 12V 15W (without Dome lights)
Max Current Consumption:	Less than 1.5A (without Dome lights)
OHM733 Dimensions:	8-1/2" x 11-3/4" x 1-3/16" (W x H x D) 216 x 300 x 31.5 mm (W x H x D)
OHM833 Dimensions:	9-1/8" x 13-3/16" x 1-3/16" (W x H x D) 232 x 336 x 31.5 mm (W x H x D)
OHM733 Weight:	3 lb (1.4 kg)
OHM833 Weight:	3.5 lb (1.6 kg)
Operation Temperature	-10°C~+60°C (14°F ~ 140°F)

MONITOR SPECIFICATIONS:

Display Type:	Color TFT Active Matrix LCD
OHM733 Display Screen Size:	7.0"
OHM833 Display Screen Size:	8.0"
Format	1440 x 234
Screen Resolution:	336,960 dots
Video Signal	1Vp-p with 75-ohm load
Video System	Auto NTSC/PAL

Free Manuals Download Website

<http://myh66.com>

<http://usermanuals.us>

<http://www.somanuals.com>

<http://www.4manuals.cc>

<http://www.manual-lib.com>

<http://www.404manual.com>

<http://www.luxmanual.com>

<http://aubethermostatmanual.com>

Golf course search by state

<http://golfingnear.com>

Email search by domain

<http://emailbydomain.com>

Auto manuals search

<http://auto.somanuals.com>

TV manuals search

<http://tv.somanuals.com>