

9. ESPECIFICACIONES

Sintonizador FM

Margen de frecuencias
..... 87,9 MHz a 107,9 MHz
Sensibilidad utilizable.....11 dBf
Sensibilidad de silenciamiento 50 dB
..... 17 dBf

Selectividad de canal alterno.....75 dB
Separación estereofónica (1 kHz).....35 dB
Respuesta en frecuencia (± 3 dB)
..... 30 Hz a 15 kHz

Sintonizador AM

Margen de frecuencias
..... 530 kHz a 1.710 kHz
Sensibilidad utilizable.....25 μ V

Cassette

Lloro y trémolo (WRMS).....0,08%
Separación de canales (1 kHz).....45 dB
Relación señal/ruido
..... 70 μ s (CrO₂, FeCr, Metal):
58 dB

Respuesta en frecuencia (± 3 dB)
120 μ s (normal).....30 Hz a 18 kHz
70 μ s (CrO₂, FeCr, Metal).....30 Hz a 20 kHz

Amplificador de Potencia

Potencia máxima.....180 W (45 W \times 4 canales)
Potencia media continua
..... 17 W \times 4, en 4 Ω , 20 Hz a 20 kHz, 1%
THD

Preamplificador

Acción de control de bajos (30 Hz)..... ± 13 dB
Acción de control de agudos (10 kHz)..... ± 10 dB
Salida de línea (con CA, 1 kHz, 10 K Ω)...1,8 V

General

Tensión de alimentación
..... 14,4 V CC (10,8 a 15,6 V permisible)
Consumo.....Menos de 15 A
Impedancia del altavoz
..... 4 Ω (4 Ω a 8 Ω permisible)
Peso.....3,52 lb. (1,6 kg)

Dimensiones
..... 7" (178 mm) Ancho \times 2" (50 mm) Alto \times
6-3/32" (155 mm) Profundo

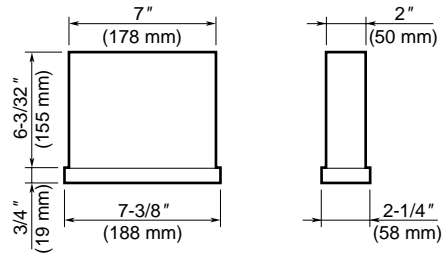

Notas:

- Las especificaciones se adecúan a las normas EIA.
- Con el propósito de introducir mejoras, las especificaciones y el diseño del producto están sujetos a cambios sin previo aviso.

Clarion®

Owner's manual
Mode d'emploi
Manual de instrucciones

INFORMATION FOR USERS:
CHANGES OR MODIFICATIONS TO THIS
ER WILL VOID THE WARRANTY AND WIL

1. FEATURES

- DIN Chassis with Detachable Co
- Z-Enhancer with 3 Mode Sound
- **MAGITUNE**® FM Reception Syst
- AM/FM Bands-1 AM, 3 FM/18 FM
- Full Logic Tape Transport with T
- Auto Reverse with Dual Azimuth
- Auto Metal Tape EQ
- Multi-Color LC Display
- 2-Channel RCA Line Level Outp
- 180 W (45 W \times 4) Maximum Pow
- Infrared Remote Control

■ Contents

English

1. FEATURES.....	2
2. CONTROLS.....	3
3. BUTTON TERMINOLOGY.....	4
4. CASSETTE PRECAUTIONS AND CARE.....	5
5. DCP (Detachable Control Panel).....	5
6. REMOTE CONTROL.....	6
7. OPERATION.....	8
8. TROUBLESHOOTING.....	13
9. SPECIFICATIONS.....	14

■ Table des matières

Français

1. CARACTÉRISTIQUES.....	15
2. COMMANDES.....	3
3. NOMENCLATURE DES TOUCHES.....	16
4. PRÉCAUTIONS ET ENTRETIEN DES CASSETTES.....	17
5. CLAVIER DE COMMANDE AMOVIBLE (DCP).....	17
6. TÉLÉCOMMANDE.....	18
7. FONCTIONNEMENT.....	20
8. DÉPISTAGE DES PANNES.....	26
9. SPÉCIFICATIONS.....	27

■ Índice

Español

1. CARACTERÍSTICAS.....	29
2. CONTROLES.....	3
3. NOMENCLATURA DE LOS BOTONES.....	30
4. PRECAUCIONES Y CUIDADOS DE LOS CASETES.....	31
5. PANEL DE CONTROL DESMONTABLE (DCP).....	31
6. CONTROLADOR REMOTO.....	32
7. OPERACIÓN.....	34
8. SOLUCIÓN DE PROBLEMAS.....	41
9. ESPECIFICACIONES.....	42

ProAudio **C-BUS**

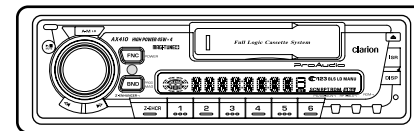

AX410

AM/FM CASSETTE
WITH CD CHANGER CONTROL

RADIO AM/FM-LECTEUR CASSETTE
AVEC PILOTAGE DE CHANGEUR CD

RADIOCASSETTE AM/FM
CON CONTROL DE CAMBIADOR DE CD

Clarion Co., Ltd.

All Rights Reserved. Copyright © 2001: Clarion Co., Ltd.
Printed in China / Imprimé en Chine / Impreso en China

PE-1712B
280-7581-00

2001/1 (D/C)

Veuillez
Cercières

2. CONTROLS / COMMANDES / CONTROLES

Note: Be sure to unfold this page and refer to the front diagrams as you read each chapter.

Remarque: Veuillez déployer cette page et vous référer aux schémas quand vous lisez chaque chapitre.

Nota: Cuando lea los capítulos, despliegue esta página y consulte los diagramas.

SOURCE UNIT / APPAREIL PILOTE / UNIDAD FUENTE

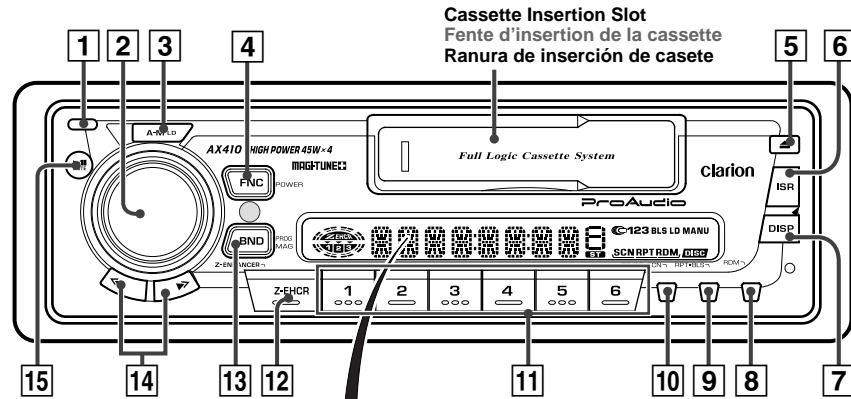

DISPLAY
AFFICHEUR
VISUALIZADOR

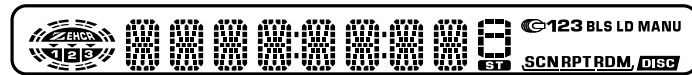

3. BUTTON TERMINOLOGY

Note:

• Be sure to read this chapter referring to the front diagrams of chapter 2. CONTROLS on page 3 (unfold).

- 1 DCP Release Button
- 2 Rotary Knob
- 3 A-M (Audio Mode) Button
LD (Loudness) Button
- 4 POWER Button
FNC (Function) Button
- 5 Eject (▲) Button
- 6 ISR (Instant Station Recall) Button
- 7 DISP (Display) Button
- 8 RDM (Random) Button
- 9 RPT (Repeat) Button
BLS (Blank Skip) Button
- 10 SCN (Scan) Button
PS/AS (Preset Scan/Auto Store) Button
- 11 Preset Buttons (1 to 6)
Direct Buttons (1 to 6)
- 12 Z-EHCR (Z-enhancer) Button
- 13 BND (Band) Button
PROG (Program) Button
MAG (Magazine) Button
- 14 SRCH (Search) Left and Right (◀ and ▶) Buttons
- 15 Play/Pause (▶/||) Button
MUTE Button

8. SOLUCIÓN DE

Problema	Causa
La unidad no se enciende. (o no hay emisión de sonido.)	El fusible se ha c Conexiones inco
La calidad del sonido es mala.	El cabezal de reproducción est
La unidad no emite sonido.	Los conductores antena motorizada cortocircuitados.

Para protección del sistema, esta unidad incluye un sistema de protección de error correspondiente. Para resolver el problema, describen a continuación.

	Indicación de error	Causa
Cinta	TAPE ER1	La cinta no puede reproducirse que esté defectuosa, por ejemplo, da.
	TAPE ER2	La cinta se ha enredado y no puede reproducirse.
	TAPE ER4	No puede detectarse el modo de reproducción.
	TAPE ER8	La cinta se ha enredado y el cabezal no puede extraerse.
Cambiador de discos compactos	CDCH ER2	No hay discos cargados en el cambiador de discos compactos.
	CDCH ER3	El disco compacto del cambiador de discos compactos no puede reproducirse debido a ralladuras, etc.
	CDCH ER6	El disco compacto del cambiador de discos compactos no puede reproducirse debido a que está cargado al revés.

Si la unidad exhibe una indicación distinta de las descritas, desconecte la alimentación y consulte en la tienda de servicio.

Clarion®

Owner's manual
Mode d'emploi
Manual de instrucciones

AX410

AM/FM CASSETTE
WITH CD CHANGER CONTROL

RADIO AM/FM-LECTEUR CASSETTE
AVEC PILOTAGE DE CHANGEUR CD

RADIOCASSETTE AM/FM
CON CONTROL DE CAMBIADOR DE CD

English

INFORMATION FOR USERS:

CHANGES OR MODIFICATIONS TO THIS PRODUCT NOT APPROVED BY THE MANUFACTURER WILL VOID THE WARRANTY AND WILL VIOLATE FCC APPROVAL.

1. FEATURES

- DIN Chassis with Detachable Control Panel
- Z-Enhancer with 3 Mode Sound Selector
- **MAGITUNE**® FM Reception System
- AM/FM Bands-1 AM, 3 FM/18 FM/6 AM Touchbutton Memory
- Full Logic Tape Transport with True Function
- Auto Reverse with Dual Azimuth Adjust
- Auto Metal Tape EQ
- Multi-Color LC Display
- 2-Channel RCA Line Level Output with Fader Control
- 180 W (45 W × 4) Maximum Power Output
- Infrared Remote Control

■ Contents

English

1. FEATURES.....	2
2. CONTROLS.....	3
3. BUTTON TERMINOLOGY.....	4
4. CASSETTE PRECAUTIONS AND CARE.....	5
5. DCP (Detachable Control Panel).....	5
6. REMOTE CONTROL.....	6
7. OPERATION.....	8
8. TROUBLESHOOTING.....	13
9. SPECIFICATIONS.....	14

■ Table des matières

Français

1. CARACTÉRISTIQUES.....	15
2. COMMANDES.....	3
3. NOMENCLATURE DES TOUCHES.....	16
4. PRÉCAUTIONS ET ENTRETIEN DES CASSETTES.....	17
5. CLAVIER DE COMMANDE AMOVIBLE (DCP).....	17
6. TÉLÉCOMMANDE.....	18
7. FONCTIONNEMENT.....	20
8. DÉPISTAGE DES PANNES.....	26
9. SPÉCIFICATIONS.....	27

■ Índice

Español

1. CARACTERÍSTICAS.....	29
2. CONTROLES.....	3
3. NOMENCLATURA DE LOS BOTONES.....	30
4. PRECAUCIONES Y CUIDADOS DE LOS CASETES.....	31
5. PANEL DE CONTROL DESMONTABLE (DCP).....	31
6. CONTROLADOR REMOTO.....	32
7. OPERACIÓN.....	34
8. SOLUCIÓN DE PROBLEMAS.....	41
9. ESPECIFICACIONES.....	42

ProAudio **C-BUS**

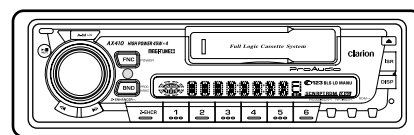

Be sure to unfold and read the next page.
Veuillez déployer et vous référer à la page suivante.
Cerciórese de desplegar y de leer la página siguiente.

AX410

2

3. BUTTON TERMINOLOGY

Note:

• Be sure to read this chapter referring to the front diagrams of chapter 2. CONTROLS on page 3 (unfold).

- 1 DCP Release Button
- 2 Rotary Knob
- 3 A-M (Audio Mode) Button
LD (Loudness) Button
- 4 POWER Button
FNC (Function) Button
- 5 Eject (▲) Button
- 6 ISR (Instant Station Recall) Button
- 7 DISP (Display) Button
- 8 RDM (Random) Button
- 9 RPT (Repeat) Button
BLS (Blank Skip) Button
- 10 SCN (Scan) Button
PS/AS (Preset Scan/Auto Store) Button
- 11 Preset Buttons (1 to 6)
Direct Buttons (1 to 6)
- 12 Z-EHCR (Z-enhancer) Button
- 13 BND (Band) Button
PROG (Program) Button
MAG (Magazine) Button
- 14 SRCH (Search) Left and Right (◀ and ▶) Buttons
- 15 Play/Pause (▶/||) Button
MUTE Button

8. SOLUCIÓN DE PROBLEMAS

Problema	Causa	Solución
La unidad no se enciende. (o no hay emisión de sonido.)	El fusible se ha quemado.	Reemplace el fusible antiguo por uno de igual amperaje.
	Conexiones incorrectas.	Lea la "Guía de instalación/conexión de cables" adjunta, y realice las conexiones correctas.
La calidad del sonido es mala.	El cabezal de reproducción está sucio.	Use una cinta de limpieza, etc., para limpiar el cabezal.
La unidad no emite sonido.	Los conductores de la antena motorizada están cortocircuitados a masa.	Desconecte en primer lugar la alimentación de la unidad. Desconecte todos los conductores de conexión de la antena motorizada, conecte la alimentación de la unidad, y después conecte, uno tras otro, los conductores de la antena motorizada. Si el sonido vuelve a silenciarse, compruebe en último lugar la unidad con un conductor conectado.

Para protección del sistema, esta unidad incorpora una serie de funciones de autodiagnóstico. Cuando se produzca un problema, el usuario será alertado de tal condición mediante la indicación de error correspondiente. Para resolver el problema, siga los procedimientos que se describen a continuación.

	Indicación de error	Causa	Solución
Cinta	TAPE ER1	La cinta no puede reproducirse debido a que esté defectuosa, por ejemplo, cortada.	Extraiga el casete y cámbielo por otro nuevo.
	TAPE ER2	La cinta se ha enredado y no puede reproducirse.	Extraiga el casete atascado o la cinta enredada.
	TAPE ER4	No puede detectarse el modo de cinta.	Éste es un problema del mecanismo del reproductor de casetes. Póngase en contacto con el comercio en el que adquirió la unidad.
	TAPE ER8	La cinta se ha enredado y el casete no puede extraerse.	Elimine la razón del enredo de la cinta.
Cambiador de discos compactos	CDCH ER2	No hay discos cargados en el interior del cambiador de discos compactos.	Éste es un problema del cambiador de discos compactos. Póngase en contacto con el comercio en el que adquirió la unidad.
	CDCH ER3	El disco compacto del cambiador de discos compactos no puede reproducirse debido a ralladuras, etc.	Reemplace el disco compacto por otro que no esté rayado ni alabeado.
	CDCH ER6	El disco compacto del cambiador de discos compactos no puede reproducirse debido a que está cargado al revés.	Extraiga el disco y cárguelo adecuadamente.

Si la unidad exhibe una indicación distinta de las descritas arriba, presione el botón de reposición. Si el problema persiste, desconecte la alimentación y consulte en la tienda donde adquirió el equipo.

4. CASSETTE PRECAUTIONS AND CARE

1. Tape slack can lead to operating difficulties. Remove tape slack before inserting a cassette, particularly when using C-90 or prerecorded cassettes.
2. Use C-30 to C-90 cassettes. Avoid use of C-120 or longer cassettes (The very thin tape may stretch or break).
3. Clean the head periodically with a good commercial head cleaner. Avoid touching the head with magnetic or hard objects.
4. Do not oil the cassette mechanism.
5. Always remove the cassette from the mechanism when not in use. Exposure to direct sunlight, extreme temperatures or high humidity may damage cassettes.
6. The cassette tape will automatically eject from the mechanism if it is damaged. Always ensure that cassette tapes are in good condition prior to use.

5. DCP (Detachable Control Panel)

The control panel can be detached to prevent theft. When detaching the control panel, store it in the included DCP case to prevent scratches. We recommend taking the control panel with you when leaving the car.

Removing the DCP

1. Turn off the power.
2. Press the DCP Release button **1**.



* The DCP is unlocked.

3. Remove the DCP.

Attaching the DCP

Insert the DCP into the right side of the source unit and press the left side to lock it.

CAUTION

Do not insert the DCP from the left side. Doing so may damage it.

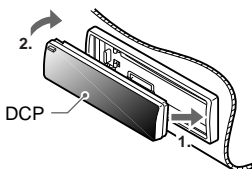

Storing the DCP in the DCP Case

Hold the DCP, in the orientation as shown in the figure below, and put it into the supplied DCP case. (Ensure the DCP is in the correct orientation.)

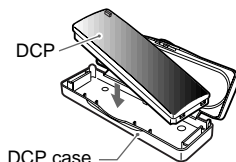

CAUTION

- The DCP can easily be damaged by shocks. After removing it, place it in its case and be careful not to drop it or subject it to strong shocks.
- When the release button is pressed and the DCP is unlocked, the car's vibrations may cause it to fall. To prevent damage to the DCP, always store it in its case after detaching it.
- The connector connecting the source unit and the DCP is an extremely important part. Be careful not to damage it by pressing on it with fingernails, pens, screwdrivers, etc.

DCP Rear Panel Source Unit Front

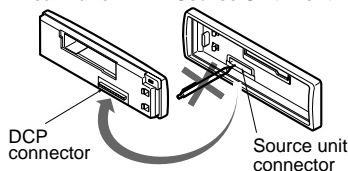

Note:

- If the DCP is dirty, wipe off with a soft, dry cloth.

6. REMOTE CONTROL

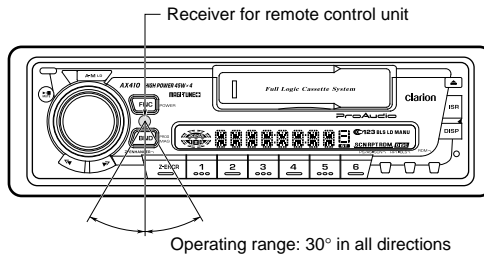

Remote control unit

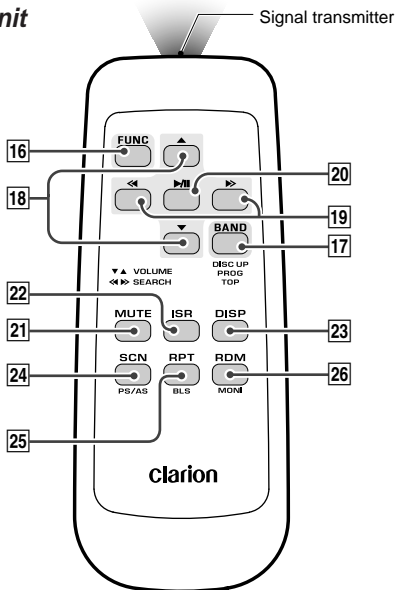

Inserting the Batteries

1. Turn the remote control unit over, then slide the rear cover in the direction of the arrow.
2. Insert the AA (UM-3/1.5 V) batteries that came with the remote control unit facing in the directions shown in the figure, then close the rear cover.

Notes:

Using batteries improperly can cause them to explode. Take note of the following points:

- When replacing batteries, replace both batteries with new ones.
- Do not short-circuit, disassemble or heat batteries.
- Do not dispose of batteries into fire or flames.
- Dispose of spent batteries properly.

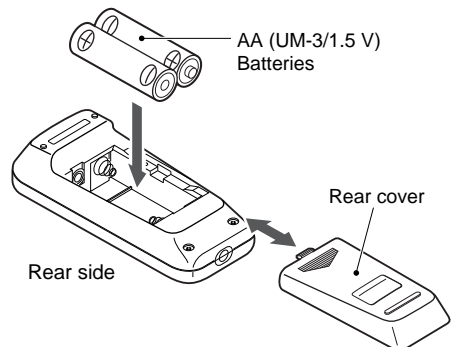

Functions of Remote Control Unit Buttons

Button \ Mode	Radio	Tape	CD changer
16 FUNC	Turns power on and off. When pressed and held for 1 second: Turns power off. Switches between radio, Tape and CD changer.		
17 BAND DISC UP PROG TOP	Switches reception band.	Switches the side of the tape.	Moves the next disc in increasing order.
18 VOLUME	Increases and decreases volume (in all modes).		
19 SEARCH	Moves preset channels up and down.	Fast-forward and rewinds tape. APC fast-forward and rewind.	Moves tracks up and down. When pressed and held for 1 second: Fast-forward/ fast-backward.
20 PLAY/PAUSE	Turns mute on and off.	Switches between playback and pause.	Switches between playback and pause.
21 MUTE	Turns mute on and off.	Switches between playback and pause.	Switches between playback and pause.
22 ISR	Recalls ISR radio station in memory. Press and hold for more than 2 seconds: Stores current station into ISR memory (radio mode only).		
23 DISP	Switches among main display, sub display and clock display.		
24 SCAN PS/AS	Preset scan. When pressed and held for 2 seconds: Auto store.	Fast-forward scan.	Scan play. When pressed and held for 1 second: Disc scan play.
25 RPT BLS	No function.	Repeat play. When pressed and held for 1 second: Blank tape skip function turns on and off.	Repeat play. When pressed and held for 1 second: Disc repeat play.
26 RDM MONI	No function.	No function.	Random play. When pressed and held for 1 second: Disc random play.

* Some of the corresponding buttons on the source unit and remote control unit have different functions.

7. OPERATION

Note:

- Be sure to read this chapter referring to the front diagrams of chapter 2. CONTROLS on page 3 (unfold).

Basic Operation

⚠ CAUTION

When this unit is turned on, starting and stopping the engine of a car with its volume raised to the maximum level may harm your hearing. Be careful about adjusting the volume.

- 1) Press the POWER button [4].
 - * To turn the power off, press the POWER button for at least 1 second.
- 2) Press the FNC button [4] to select the operation mode. The mode switches as follows each time the FUNC button is pressed:
Radio → Tape → CD changer → Radio
 - * If a component is not connected, that operation mode cannot be selected.
 - * "NO CASS" appears when no tape is loaded in the source unit, and "NO DISC" appears when no disc is loaded in the CD changer.
- 3) Turning the Rotary knob [2] clockwise increases the volume; turning it counterclockwise decreases the volume.
 - * The volume level is from 0 (minimum) to 33 (maximum).

Audio Mode Adjustments

Press the A-M button [3] to select the adjustment mode. The mode switches as follows each time the A-M button is pressed:
BASS → TREB → BAL → FAD → Previous mode

Adjusting the Bass

- 1) Press A-M button [3] and select "BASS".
- 2) Turning the Rotary knob [2] clockwise emphasizes the bass; turning it counterclockwise attenuates the bass.
 - * The factory default setting is "0". (Adjustment range: -6 to +6)
- 3) When the adjustment is complete, press A-M button [3] several times until the function mode is reached.

Adjusting the Treble

- 1) Press A-M button [3] and select "TREB".
- 2) Turning the Rotary knob [2] clockwise emphasizes the treble; turning it counterclockwise attenuates the treble.
 - * The factory default setting is "0". (Adjustment range: -6 to +6)
- 3) When the adjustment is complete, press A-M button [3] several times until the function mode is reached.

Adjusting the Balance

- 1) Press A-M button [3] and select "BAL".
- 2) Turning the Rotary knob [2] clockwise emphasizes the sound from the right speaker; turning it counterclockwise emphasizes the sound from the left speaker.
 - * The factory default setting is "0". (Adjustment range: L9 to R9)
- 3) When the adjustment is complete, press A-M button [3] several times until the function mode is reached.

Adjusting the Fader

- 1) Press A-M button [3] and select "FAD".
- 2) Turning the Rotary knob [2] clockwise emphasizes the sound from the front speakers; turning it counterclockwise emphasizes the sound from the rear speakers.
 - * The factory default setting is "0". (Adjustment range: F9 to R9)
- 3) When the adjustment is complete, press A-M button [3] several times until the function mode is reached.

Setting the Z-enhancer

This unit comes with three types of sound tone effects stored in memory. Select the one you prefer.
* The factory default setting is "Z-EHCR OFF".
Each time you press Z-EHCR button [12], the tone effect changes in the following order.
"Z-ENHANCER 1" → "Z-ENHANCER 2" →
"Z-ENHANCER 3" → "Z-EHCR OFF" →
"Z-ENHANCER 1"...

- Z-ENHANCER 1: bass emphasized
- Z-ENHANCER 2: treble emphasized
- Z-ENHANCER 3: bass and treble emphasized
- Z-EHCR OFF: no sound effect

Loudness Function

Press the LD button [3] for at least 1 second to turn the loudness function on and off.

Switching the Display

Press the DISP button [7] to enter the clock display mode.
 Operation mode display → Clock display → Operation mode display

Setting the Clock

- 1) Press the DISP button [7] to enter the clock display mode.
- 2) Press the DISP button [7] for 1 second or more. This enables clock editing.
 * The editable fields will be indicated by flash.
- 3) To move between the hour and minute fields, use the SRCH Left (hour) and Right (minute) buttons [14].
- 4) To confirm the clock setting, press the DISP button [7].

Notes:

- If you select another operation mode before completing the above procedure, the clock setting operation will be canceled.
- Removing the battery for a check or repair causes the clock to be reset. Set the clock again in such a case.

Tape Operation

Loading Tapes

Insert the cassette tape into the Cassette insertion slot with the side on which the tape is exposed facing the right. Playback starts automatically.

- * The metal tape setting is set automatically when a metal or chrome tape is loaded.
- * When the end of the cassette tape is reached, the auto reverse mechanism is activated and the other side of the tape begins playing automatically.

Listening to a tape which is already loaded

Press the FNC button [4] to select the tape mode. Playback begins automatically.

Stopping Playback Temporarily

Press the Play/Pause button [15]. Press the button again to resume playback.

Ejecting Cassette Tapes

Press the Eject button [5]. The cassette tape is ejected.

Fast-Forwarding and Rewinding

Use the SRCH Left and Right buttons [14].

- ▶▶: Press this to fast-forward the tape.
- ◀◀: Press this to rewind the tape.

APC (Auto Program Control)

Press the SRCH Left or Right button [14] twice.

- ▶▶: Press this twice to move ahead to the beginning of the next selection.
- ◀◀: Press this twice to move back to the beginning of the current selection.

Switching to the Other Side of the Tape

Press the PROG button [13]. Playback is switched to the other side of the cassette tape.

FF Scan Function (Intro Music Scan)

When the SCN button [10] is pressed, "SCN" appears on the display, and the first 10 seconds of all the tracks on the cassette tape are played. Press the SCN button again to stop scanning.

Repeat Function (Repeat Play)

When the RPT button [9] is pressed, "RPT" appears on the display and the current track is played repeatedly. Press the RPT button again to cancel the repeat mode.

Blank Skip Function

Use this function to automatically skip to the beginning of the next recorded section when there is a blank section of 12 seconds or more on the tape.

When the BLS button [9] is pressed for 1 second or longer, the blank skip mode is set and "BLS" appears on the display. Press the BLS button [9] again for 1 second or longer to cancel the blank skip mode.

Notes:

The APC, scan, repeat and blank skip functions will not work with the following types of tapes:

- Tapes on which the recording level is low
- Tapes on which there is less than 4 seconds of blank space between selections
- Tapes on which there are long pauses in the middle of selections
- Tapes on which there is much noise between selections

Radio Operation

FM Reception

For enhanced FM performance the **MAGITUNE3**® tuner includes signal actuated stereo control and Multipath noise reduction circuits.

Listening to the Radio

- 1) Press the FNC button [4] and select the radio mode. The radio turns on.
- 2) To tune in a preset station, first press the BND button [13] and select FM1, FM2, FM3 or AM.
The band changes as follows each time the BND button is pressed:
FM1 → FM2 → FM3 → AM → FM1
- 3) Use the Preset buttons [11] to select the desired station.

Mute

Use this function to turn off the sound immediately.

Press the MUTE button [15]. The sound turns off and "MUTE" appears on the display. Press the MUTE button again to cancel the mute mode.

Seek Tuning

- 1) Press the BND button [13] and select the desired band.
- 2) Press the SRCH Left or Right button [14]. Seek tuning automatically stops when a station is found.

Manual Tuning

- 1) Press the BND button [13] and select the desired band.
- 2) Press the BND button again for more than 1 second. "MANU" lights in the display and the manual tuning mode is set.
- 3) Use the SRCH Left and Right buttons [14] to tune in the desired frequency.

Presetting Stations

A total of 24 stations can be preset, 6 each for the FM1, FM2, FM3 and AM bands.

Note:

- When a station is preset, the station previously stored in the memory at that position is cleared.

Presetting stations manually

- 1) Press the BND button [13] to select the band at which to store the station.
- 2) Use the SRCH Left and Right buttons [14] to tune in the station to be preset.
- 3) Press the Preset button [11] at which you want to store that station for at least 2 seconds.

Auto store function (Automatic Station Store)

- 1) Press the BND button [13] to select the band at which to store the stations.
- 2) Press the AS button [10] for at least 2 seconds. Stations with good reception are automatically stored at Preset buttons [11] 1 to 6.

* If there are fewer than 6 stations with good reception, the stations previously stored at the remaining buttons are not cleared.

Preset Scanning (Preset Station Scan)

When the PS button [10] is pressed, the preset memory numbers flash and the stations are tuned in for 7 seconds each in the order in which they were stored. Press the PS button again to cancel the preset scanning mode.

Instant Station Recall (ISR) Function

This function allows you to recall a specific radio station from any mode. Use it to find stations quickly when you want to hear specific information (such as traffic announcements) while driving. The ISR station is set to 87.9 MHz upon shipment from the factory.

Setting the ISR station

- 1) Press the FNC button [4] to select the radio mode.
- 2) Tune in the station to be set as the ISR station.
- 3) Press the ISR button [6] for more than 2 seconds to store that station in the memory as the ISR station.

Recalling the ISR station

Press the ISR button [6] from any mode. "ISR" appears on the display and the set station is tuned in. To cancel, press the ISR button again.

Area Change Function

Use this to listen to the radio outside of the United States.

Switchable frequency spacing

This car stereo is initially set to tune in frequency intervals of 10 kHz for AM and 200 kHz for FM, the standard calibrations in the U.S. When using the unit outside the U.S., use the following procedure to switch the frequency steps and frequency range:

- 1) Turn the power on and set the tuner mode.
- 2) Keep the BND button [13] pressed and while pressing the button, press the SRCH Left button [14].

- 3) Release the buttons.

This procedure changes the factory setting to 9 kHz steps for AM and 50 kHz steps for FM, the standard calibrations for countries other than the U.S.

To change the AM/FM setting back to the U.S. standard frequencies:

- 1) Set the tuner mode.
- 2) While pressing the BND button [13], press the SRCH Right button [14].
- 3) Release the buttons.

Your car stereo will once again be calibrated to receive standard U.S. transmissions.

The chart below lists the frequency specifications for the U.S. and other countries.

		Initial Setting (U.S. standard)	New Setting (outside U.S.)
AM	Frequency spacing	10 kHz	9 kHz
	Frequency range	530 to 1710 kHz	531 to 1629 kHz
FM	Frequency spacing	200 kHz	50 kHz
	Frequency range	87.9 to 107.9 MHz	87.5 to 108 MHz

CD Changer Operation

When a separately sold CD changer is connected, it can be controlled from the source unit.

Notes:

- Some CDs recorded in CD-R mode may not be usable.
- Even when recorded in CD-R/W mode, some CDs may not be usable.

Listening to the Disc

Press the FNC button [4] and select the CD changer mode, then the CD starts playing.

Stopping (pausing) Playback

Press the Play/Pause button [15].
Press the Play/Pause button [15] again to resume playback.

Selection of CDs

Press the Direct button [11] to select 1 to 6, then select the CD you wish to play.

Selecting Tracks (songs)

Press the SRCH Left and Right buttons [14].

- ▶▶: Playback will start from the next track.
- ◀◀: Playback will start from the beginning of the track currently playing. When this button is pressed again, the CD will play from the previous track.

Fast-Forward and Fast-Backward

Press and hold the SRCH Left and Right buttons [14].

- ▶▶: To fast-forward
- ◀◀: To fast-backward

* Pressing the SRCH Left / Right button for 1 second or longer will move forward or backward 5 times faster than normal play, and pressing it for 3 seconds or longer will do the operation 30 times faster.

Scan Play (Intro Music Scan)

Press the SCN button [10], then the display shows "SCN", then the CD will play the first 10 seconds of all the tracks of all CDs. Press the SCN button [10] again to disengage the unit from scan play.

* A scan play will start from the track following the one currently playing.

Disc scan play

Press and hold the SCN button [10] for 1 second or longer, then the display will show "DISC" and "SCN", and plays the first 10 seconds of the first tracks of all the CDs in the CD changer.

Press the SCN button [10] again to disengage the unit from disc play.

* A scan play will start from the first tracks of next CDs following the one currently playing.

Repeat Play

Press the RPT button [9], then the display shows "RPT", then the track currently playing will be played repeatedly. Press the RPT button [9] again to disengage the unit from repeat play.

Disc repeat play

Press and hold the RPT button [9] for 1 second or longer, then the display shows both the "DISC" and "RPT", then the disc currently being played will be played repeatedly.

Press the RPT button [9] again to disengage the unit from disc repeat play.

Random Play

Press the RDM button [8], then the display will show "RDM", then the entire tracks on the disc will be played at random.

Press the RDM button [8] again to disengage the unit from disc random play.

Disc random playback

Press and hold the RDM button [8] for 1 second or longer, then the display will show both the "DISC" and "RDM", then the entire tracks of all the discs in the CD changer will be played at random.

Press the RDM button [8] again to disengage the unit from disc play.

Switching Magazine

This function can be used only when the connected CD changer can store a multiple number of magazines.

Every time the MAG button [13] is pressed, the next magazine will be selected.

8. TROUBLESHOOTING

Problem	Cause	Measure
Power does not turn on. (or no sound is produced.)	Fuse is blown.	Replace with a fuse of the same amperage as the old fuse.
	Connections are improper.	Read the attached "Installation/Wire Connection Guide" once again and wire properly.
Sound quality is poor.	Playback head is dirty.	Use a cleaning tape, etc. to clean the head.
No sound while unit can be operated.	Power ANT lead is shorted to the ground.	Turn the unit off, first. Remove all connecting wires from the power ANT lead, and turn the unit on, then re-connect a wire one by one to the power ANT lead. When sound is muted again, check the unit with a wire connected last.

This unit is equipped with a number of self-diagnosis functions to protect the system. If a problem should occur, the user is warned through various error displays. Eliminate the problem using the procedures shown below.

	Error Display	Cause	Measure
Tape	TAPE ER1	Tape cannot be played due to defective tape such as cut tape.	Eject the tape then replace it with a new one.
	TAPE ER2	Tape is caught and cannot be played.	Remove the caught or wound tape.
	TAPE ER4	Tape mode cannot be detected.	This is a failure of tape mechanism and consult your store of purchase.
	TAPE ER8	Tape is caught and cannot be ejected.	Eliminate the reason for which the tape is caught.
CD changer	CDCH ER2	A CD inside the CD changer is not loaded.	This is a failure of CD changer's mechanism and consult your store of purchase.
	CDCH ER3	A CD inside the CD changer cannot be played due to scratches, etc.	Replace with a non-scratched, non-warped disc.
	CDCH ER6	A CD inside the CD changer cannot be played because it is loaded upside-down.	Eject the disc then reload it properly.

If a display other than one of the displays above appears, press the reset button. If the problem persists, turn the power off and contact your store of purchase.

9. SPECIFICATIONS

FM Tuner

Frequency Range.....87.9 MHz to 107.9 MHz
Usable Sensitivity.....11 dBf
50 dB Quieting Sensitivity.....17 dBf
Alternate Channel Selectivity.....75 dB
Stereo Separation (1 kHz).....35 dB
Frequency Response (± 3 dB)
.....30 Hz to 15 kHz

AM Tuner

Frequency Range.....530 kHz to 1,710 kHz
Usable Sensitivity.....25 μ V

Tape

Wow & Flutter (WRMS).....0.08%
Channel Separation (1 kHz).....45 dB
Signal to Noise Ratio
..... 70 μ s (CrO₂, FeCr, Metal):
58 dB
Frequency Response (± 3 dB)
120 μ s (normal).....30 Hz to 18 kHz
70 μ s (CrO₂, FeCr, Metal).....30 Hz to 20 kHz

Power Amplifier

Maximum Power Output.....180 W (45 W \times 4ch)
Continuous Average Power Output
..... 17 W \times 4, into 4 Ω , 20 Hz to 20 kHz,
1% THD

Pre-Amplifier

Bass Control Action (30 Hz)..... ± 13 dB
Treble Control Action (10 kHz)..... ± 10 dB
Line Output (with A/C 1 kHz, 10 k Ω).....1.8 V

General

Power Supply Voltage
..... 14.4 V DC (10.8 V to 15.6 V allowable)
Current Consumption..... Less than 15 A
Speaker Impedance
..... 4 Ω (4 Ω to 8 Ω allowable)
Weight.....3.52 lb. (1.6 kg)
Dimensions
..... 7" (178 mm) Width \times 2" (50 mm) Height
 \times 6-3/32" (155 mm) Depth

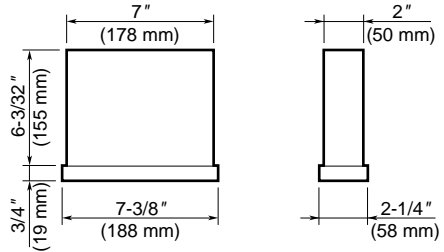

Notes:

- Specifications comply with EIA Standards.
- Specifications and design are subject to change without notice for further improvement.

Free Manuals Download Website

<http://myh66.com>

<http://usermanuals.us>

<http://www.somanuals.com>

<http://www.4manuals.cc>

<http://www.manual-lib.com>

<http://www.404manual.com>

<http://www.luxmanual.com>

<http://aubethermostatmanual.com>

Golf course search by state

<http://golfingnear.com>

Email search by domain

<http://emailbydomain.com>

Auto manuals search

<http://auto.somanuals.com>

TV manuals search

<http://tv.somanuals.com>