

Clarion®

Owner's manual & Installation manual

使用说明书和安装说明书

사용 설명 및 설치 설명서

TB731P **TB732P** **TB733W**

IN-DASH WIDE 7" COLOR LCD TV

IN-DASH (可藏入仪表板中) 7英寸宽型彩色LCD (液晶显示) 电视机

와이드 7인치 컬러 LCD TV 계기반

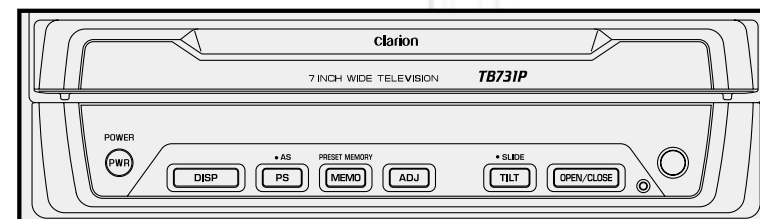

Clarion Co., Ltd.

All Rights Reserved. Copyright © 2003: Clarion Co., Ltd.

QZ7532K
280-7960-00

Thank you for purchasing the Clarion **TB731P/TB732P/TB733W**.

* Please read this Owner's manual & Installation manual in its entirety before proceeding with wire connection and installation.

* After reading this manual, be sure to keep it in a handy place (e.g., glove compartment).

■ Contents

• Owner's manual

1. FEATURES	3
2. PRECAUTIONS	4
3. CONTROLS	5
4. BUTTON TERMINOLOGY	6
5. CAUTIONS ON HANDLING	7
Concerning the LCD screen	7
Cleaning	7
Concerning the wide screen	7
6. REMOTE CONTROL	8
7. OPERATION	10
Basic Operations	10
TV Mode Operations	13
8. TROUBLESHOOTING	17
9. SPECIFICATIONS	19

• Installation and Wire connection manual

1. BEFORE STARTING	21
2. PACKAGE CONTENTS	21
3. GENERAL CAUTIONS	21
4. CAUTIONS ON INSTALLATION	22
5. INSTALLING THE MAIN UNIT	23
6. REMOVING THE MAIN UNIT	25
7. CAUTIONS ON WIRING	25
8. WIRE CONNECTIONS	26
9. SAMPLE SYSTEMS	28

따로 판매하는 접속용 부품

■ TV 안테나 (첨가되는 영상용 안테나)

모델 번호	적용	시스템 번호	주목
ZCP-104	자동차용의 TV 안테나	4	부스터 장착의 필름 형식 안테나
ZCA-404	자동차용의 TV 안테나(다양성)	4	왼쪽 오른쪽의 1 세트 (신축성 자재)
ZCP-100	자동차용의 TV 안테나(다양성)	4	부스터 장착
ZCB-303	자동차용의 TV 안테나(다양성)	2	

* 위에서 언급한 리스트에 다양한 전환 어댑터, 확장 코드, 안테나 및 다른 부품을 첨가해도 유효합니다. 상세한것은, 구입처나 가까운 Clarion 서비스 계열 판매점과 상의하십시오.

1. FEATURES

- 7" Wide (16:9) TFT Active Matrix Color LCD Panel
- 4 Modes Supported: Cinema, Wide, Full Wide and Normal
- Wide Viewing Angle, Low Reflection and High-brightness Panel Employed
- Fully-Motorised Mechanism
- Preset Tuning (total of 12 stations), Manual Tuning and Automatic Tuning Facilities for Speedy Selection of Any Broadcast Station
- Very Easy and Functional Operation
- Built-in 4-channel Diversity Unit
- 2 AV input (RCA/DIN)
- 1 AV output (RCA)
- RADIO ANT IN/OUT (TB731P, TB732P only)

2. PRECAUTIONS

⚠ CAUTION

For your safety, the driver should not watch the TV or operate the controls while driving. Please note that watching and operating the TV while driving is prohibited by law in some countries. Also, while driving, keep the volume to a level at which external sounds can be heard.

1. When the inside of the car is very cold and the player is used soon after switching on the heater, moisture may form on the disc or the optical parts of the player and proper playback may not be possible. If moisture forms on the disc, wipe it off with a soft cloth. If moisture forms on the optical parts of the player, do not use the player for about one hour and the condensation will disappear naturally to allow normal operation.
2. Driving on extremely bumpy roads which cause severe vibration may cause the sound to skip.

3. This unit uses a precision mechanism. Even in the event that trouble arises, never open the case, disassemble the unit, or lubricate the rotating parts.

4. TV broadcast reception
When receiving TV broadcasts, the strength of the signals changes since the car is moving, so in some cases it may not be possible to receive clear pictures.

- TV signals are strongly linear, so reception is affected by buildings, mountains, and other obstacles.
- Such external factors as electric train lines, high voltage lines, and signal devices may disturb the picture or cause noise.
- * If the reception is poor, switch to a station with good reception.

CHANGES OR MODIFICATIONS TO THIS PRODUCT NOT APPROVED BY THE MANUFACTURER WILL VOID THE WARRANTY.

3. CONTROLS/控制器/컨트롤

Note: Be sure to spread this page and refer to the front diagrams when you read each chapter.

注意: 在您阅读每一章时请把本页打开, 并与前视图对照。

참고: 이 페이지를 펼쳐두고, 각 장을 읽을때 전면 그림을 참조하도록 하십시오.

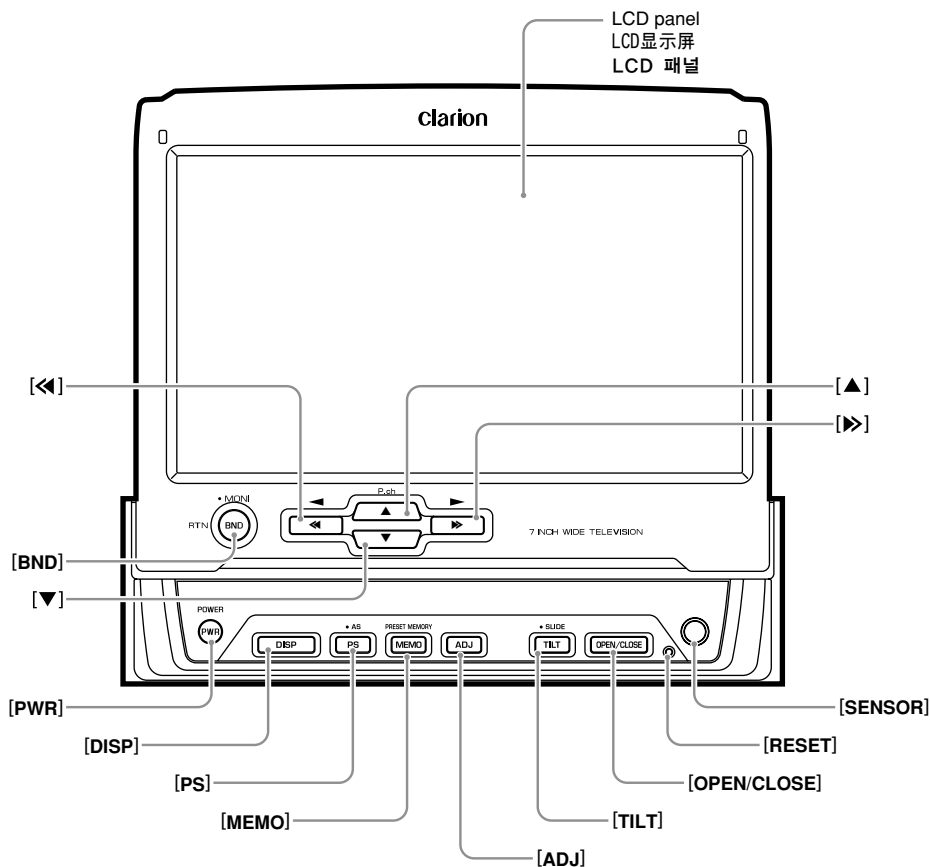

4. BUTTON TERMINOLOGY

Note: Be sure to read this chapter referring to the front diagrams of chapter "3. CONTROLS" on page 5 (spread).

[OPEN/CLOSE] button

- Use this button to open/close the liquid crystal panel.
- Press and hold this button for about 2 seconds or longer so that the liquid crystal panel is positioned horizontally when the liquid crystal panel is open. Press the button again to return the panel to the original position. Even if the button is not pressed, the panel returns to the original position after about 10 seconds.

[TILT] button

- Use this button to adjust the angle of the liquid crystal panel in 5 steps.
- Each time this button is pressed and held for about 2 seconds or longer, the liquid crystal panel moves forward/backward in 3 steps.

[ADJ] button

- Shows the ADJUST MODE menu to change the settings.

[MEMO] button

- Shows the manual memory screen to store the station.
- Press and hold this button for 1 second or longer to store the station in manual memory function.

[PS] button

- Press to perform preset scans.
- Press and hold for 1 second or longer to perform the auto store operation.

[DISP] button

- Press this button to show the information on the screen.
- Press and hold this button for 1 second or longer to switch the display sizes.

[PWR] button

- Press this button to turn on/off the power.

[BND] button

- Press this button to switch the receiving bands.
- Press and hold this button for 1 second or longer to turn on/off the monitor.
- Press this button to return to the previous screen in the adjustment menu screen.

[◀], [▶] buttons

- Press to perform the Manual tuning operation.
- Press and hold for 1 second or longer to perform the Seek tuning operation.
- Press to select the desired mode in adjustment menu screen.

[▲], [▼] buttons

- Press to select the preset channel.
- Press to select the desired menu in adjustment menu screen.

[SENSOR]

- Remote control infrared sensor.

[RESET]

- Press [OPEN/CLOSE] button or [TILT] button, the LED of this button blinks.
- Press this button, frequencies of TV, etc. stored in memory are cleared.

5. CAUTIONS ON HANDLING

For a longer service life, be sure to read the following cautions.

- Be sure to store the LCD panel inside the source unit when parking the car outdoors for long periods of time.
The LCD panel will operate properly in a temperature range of 0 to 60°C.
- Don't allow any liquids on the set from drinks, umbrellas etc. Doing so may damage the internal circuitry.
- Do not disassemble or modify the set in any way. Doing so may result in damage.
- Do not draw the LCD panel out and use it as a tray. Also, subjecting the LCD panel to shocks may result in breakage, deformation or other damage.
- Do not let cigarettes burn the display. Doing so may damage or deform the cabinet.
- Do not insert objects into the video input jack.
- If a problem should occur, have the set inspected at your store of purchase.
- Do not insert objects or poke in the space between the LCD panel and the source unit when the panel is tilted.
- Do not place anything on the display when the LCD panel is tilted.
- Do not hold on the screen when adjusting the angle of the LCD panel. Doing so may damage it.
- The remote controller may not work if the remote control sensor is exposed to direct sunlight.
- The fluorescent light used behind the screen eventually wears out. It should be replaced if the picture becomes extremely dark or flickers.
- The LCD panel may stop temporarily when it is opened or closed when the engine is stopped or when it is cold. This is not a malfunction. If this happens, repeat the operation.

Concerning the LCD screen

- Do not leave droplets of water on the LCD panel since they can cause discoloration and stains. In addition, entry of moisture inside the unit can cause malfunctioning. Any drops of water on the panel should be removed immediately using absorbent cotton or a soft cloth.
- In extremely cold weather, the movement of the picture may be slow and the screen may be dark, but this is not a malfunction. The set will work normally once the temperature increases.
- Small black and shiny dots inside the LCD panel are normal for LCD products.

Cleaning

- ***Cleaning the cabinet***
Use a soft, dry cloth and gently wipe off the dirt.
For tough dirt, apply some neutral detergent diluted in water to a soft cloth, wipe off the dirt gently, then wipe again with a dry cloth. Do not use benzene, thinner, car cleaner, etc., as these substances may damage the cabinet or cause the paint to peel. Also, leaving rubber or plastic products in contact with the cabinet for long periods of time may cause stains.
- ***Cleaning the LCD panel***
The LCD panel tends to collect dust, so wipe it off occasionally with a soft cloth.
The surface is easily scratched, so do not rub it with hard objects.

Concerning the wide screen

- A wide-screen TV comes with a function for selecting various screen modes. If you select a screen mode that differs from the picture ratio of the TV program or other software media, you will not be able to view the original pictures as was originally intended. Bear this point in mind when selecting the screen mode.

6. REMOTE CONTROL

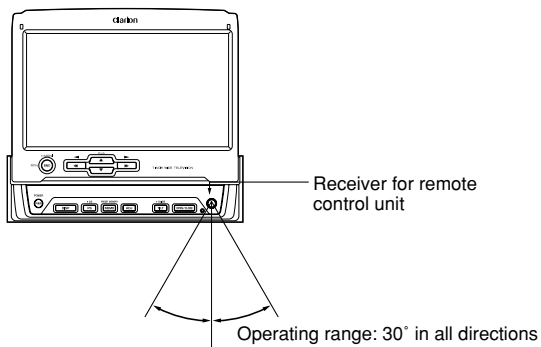

Remote control unit

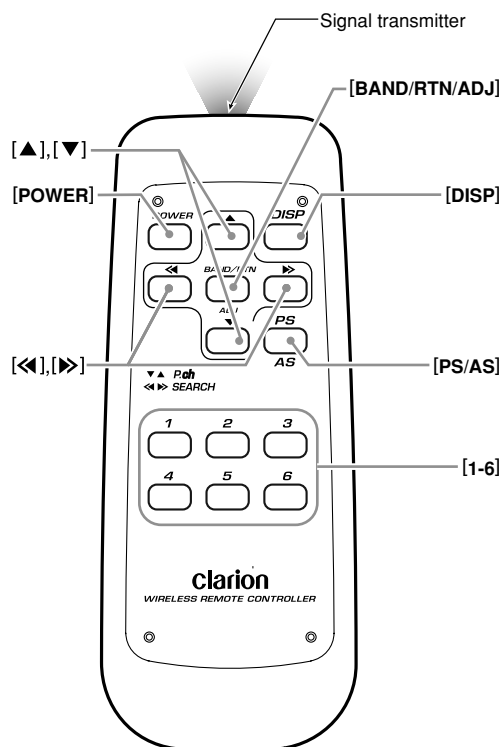

Inserting the Battery

1. Turn the remote control unit over, then slide the rear cover in the direction of the arrow.
2. Insert the AA (SUM-3/1.5V) batteries that came with the remote control unit facing in the directions shown in the figure, then close the rear cover.

Notes:

- Using batteries improperly can cause them to explode. Take note of the following points:
- When replacing batteries, replace both batteries with new ones.
 - Do not short-circuit, disassemble or heat batteries.
 - Do not dispose of batteries into fire or water.
 - Dispose of spent batteries properly.

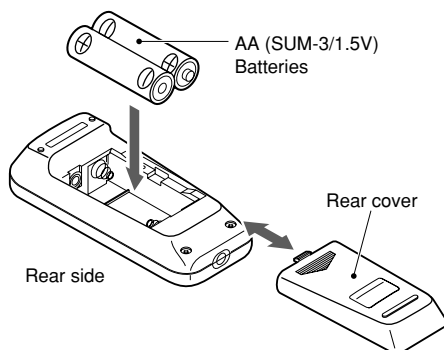

Functions of Remote Control Unit Buttons

[POWER] button

- Power on/off.

[DISP] button

- Showing the information on the screen.
- Hold down (for 1 second) to select the screen sizes.

[▲], [▼] buttons

- Selecting the preset channel.
- Selecting the desired menu in the adjustment menu screen.

[BAND/RTN/ADJ] button

- Switching the receiving bands.
- Change to the previous screen in the adjustment menu screen.
- Hold down for 1 second to show the adjustment menu screen.

[◀], [▶] buttons

- Manual tuning UP/DOWN.
- Selecting the desired mode in the adjustment menu screen.
- Hold down for 1 second for Seek tuning.

[PS/AS] button

- Preset scan.
- Hold down for 1 second for auto store.

[1-6] buttons

- Selecting the preset channel directly.
- Hold down for 1 second to store the current station into preset memory.

7. OPERATION

Basic Operations

Note: Be sure to read this chapter referring to the front diagrams of chapter "3. CONTROL" on page 5 (spread).

CAUTION

To prevent the battery from running down, operate the unit while the engine is running whenever possible.

When listening to the sound of TV programs while driving, use a volume setting at which you will still be able to hear sounds outside the vehicle.

When the liquid crystal panel is operating, be careful not to get your hand or finger caught between the panel and main unit or the instrument panel of the car.

Note:

- Use this unit after starting the engine.



Turning on and off the power

Note:

- Be careful about using this unit for a long time without running the engine. If you drain the car's battery too far, you may not be able to start the engine and this can reduce the service life of the battery.

- Press the [PWR] button.
- The illumination and display on the unit light up. The unit automatically remembers its last operation mode and will automatically switch to display that mode.
- Press the [PWR] button to turn off the power for the unit.

Standing up the liquid crystal panel

- Press the [OPEN/CLOSE] button and the liquid crystal panel comes out and stand up automatically.

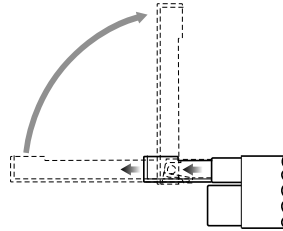

- While the liquid crystal panel is opening or closing, the LED of the [RESET] button blinks.

Note:

- If the liquid crystal panel stops in the middle of its operation, press the [OPEN/CLOSE] button to house the panel and press the button again to stand it up. The unit enters the same display mode as the display was turned off the last time.

Adjusting the angel, etc. of the liquid crystal panel

The angle of the liquid crystal panel or protruding amount of the panel from the mounting surface can be adjusted depending on the mounting angle of the unit or light coming into the car.

To adjust the angle

- Every time the [TILT] button is pressed, the liquid crystal panel tilts forward or backward at up to about 20 degrees. The adjusted angel is stored in memory.

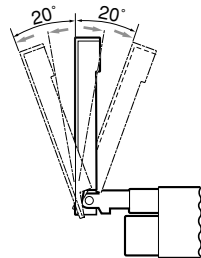

Basic Operations

Note:

- Do not move the liquid crystal panel by hand.

To adjust the slide position

- Press and hold the [TILT] button and release when a beep is heard. The liquid crystal panel slides forward or backward. The adjusted slide position is stored in memory.
 - There are 3 adjustable positions available on this panel.

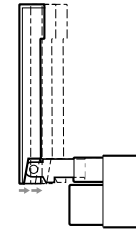

Housing the liquid crystal panel

- Press the [OPEN/CLOSE] button and the liquid crystal panel is housed automatically.

Note:

- When leaving this unit unused for a long period of time or leaving your car, be sure to house the liquid crystal panel into the main unit.

Turning the liquid crystal panel horizontal (Air conditioner operation mode)

When the way the liquid crystal panel is mounted hinders the operation of the air conditioner, the position of the panel can be turned horizontal temporarily.

- Press and hold the [OPEN/CLOSE] button when the liquid crystal panel is upright, and release the button when a beep is heard.
- The liquid crystal panel turns horizontal.
 - Press the [OPEN/CLOSE] button again when the liquid crystal panel is in the horizontal position, and the panel returns to the original position.
 - Even if the button is not operated for about 10 seconds, the panel returns to the original position with a warning sound.

Turning on and off the monitor

- Pressing and holding the [BND] button for 1 second or longer turns the monitor off. To return to the monitor on, press the [BND] button once again.
 - When a button is pressed or during security monitoring, the monitor-off mode is canceled.

Car stereo adjustments

- Set the car stereo's radio frequency to the modulator frequency. (TB731P/TB732P only)
 - The factory set for the modulator frequency is 88.1 MHz. (Refer to the section on selecting the FM modulator frequency on page 15.)
- Use the car stereo's volume and tone controls to adjust the volume and tone to the desired levels.

Note:

- Adjust also the BASS (bass)/TREB (treble) and BAL (left/right balance)/FAD (front/back balance) controls to the optimum positions.

Basic Operations

Selecting the screen size

Four screen display modes are supported: normal, wide, full wide and cinema.

Note:

- The screen mode cannot be selected while the vehicle is in motion.

Note:

- When the wide mode or full wide mode is used to display a normal 4:3 picture which is not a wide picture so that it fills the whole wide TV screen, parts of the picture around the edges will be off the screen or the picture will be distorted on the screen. To view original pictures so as to respect the intentions of the producer, use the normal mode.

Press the [DISP] button for 1 second or longer to select the screen display mode. Each time this button is pressed for 1 second or longer, the display mode is changed in the sequence shown below.

■ **For normal 4:3 picture reception**

Depending on which mode is set, the shape of the picture will be distorted on the screen.

● **Full wide mode**

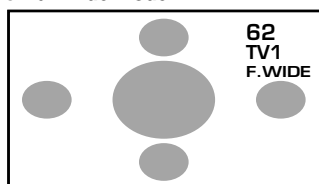

The whole picture is stretched in the sideways direction.

● **Cinema mode**

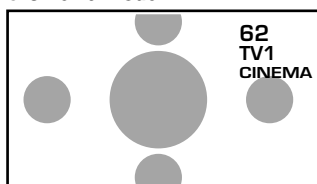

The picture at the top and bottom of the screen is off the screen.

● **Wide mode**

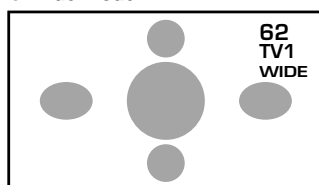

The picture at the left and right of the screen is stretched in the sideways direction. In wide mode, the picture is stretched in both the upward and downward direction when a PAL signal is received.

● **Normal mode (normal screen)**

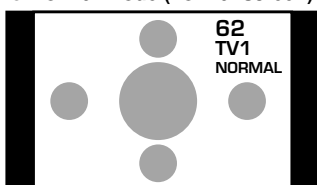

Black bands appear to the left and right of the screen.

■ **For wide (16:9) picture reception**

Use the cinema mode.

● **Normal mode**

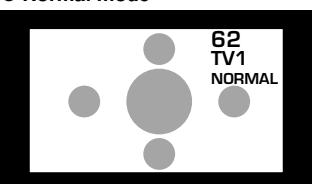

Black bands appear all around the screen.

● **Cinema mode**

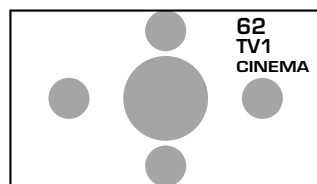

The picture is shown expanded so that it fills the whole screen.

TV Mode Operations

CAUTION

For your safety, the driver should not watch the TV or operate the controls while driving. Please note that watching and operating the TV while driving is prohibited by law in some countries. Also, while driving, keep the volume to a level at which external sounds can be heard.

Watching TV

- Press the [BND] button to select TV1, TV2, VTR1 or VTR2. Each time the [BND] button is pressed, the setting is switched in the sequence shown below.

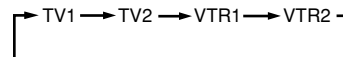

Seek tuning

Keep pressing the [◀] or [▶] button for about 1 second.

The seek tuning mode is selected. Tuning will stop automatically at a channel where a broadcast is received.

- When seek tuning has stopped before or after a broadcast channel, press the [◀] or [▶] button again.

Manual tuning

Press the [◀] or [▶] button to select the channel.

The channel number appears at the top right of the screen.

- Each time the [◀] or [▶] button is pressed, the channel number is incremented or decremented by 1.

- The channel number remains on the screen for about 5 seconds.

Preset memory function

The number of preset channels which can be stored in the memory is:

- 6 stations for TV1
 - 6 stations for TV2
- Total of 12 stations

Any station can be stored in any preset channel.

Auto store function

The channels received automatically are automatically stored in the preset channels. The setting procedure for the preset channels is the same for TV1 and TV2.

- Press the [PS] button for 1 second or longer, the broadcast stations are automatically stored in the memory starting with the one following the station now received.



Notes:

- The signal conditions are sometimes such that a channel without a station is stored in the memory.
- Some stations may not be stored if their signals are too weak in the reception area.
- When a station could not be stored or a channel without a station has been stored in the memory, refer to the section on the manual memory function which follows, and perform the settings again.

Manual memory function

- Press the [BND] button to select TV1 or TV2.
- Press the [MEMO] button, the manual memory screen is displayed.
 - While the channel display at the left of the screen turns red, the manual memory operation is available.
- Press the [◀] or [▶] button to select the channel to be preset.
- Press the [▲] or [▼] button to select the preset channel in which the station to be stored.
- Press the [MEMO] button for 1 second or longer to store the station into the preset memory.
- To cancel the manual memory mode, press the [MEMO] button again and press the [DISP] button.

Note:

- The memory contents are returned to the default settings when the battery is replaced or the power supply is otherwise suspended.

TV Mode Operations

Preset scanning

1. Press the [PS] button.
The stations stored in sequence at intervals of about 5 seconds per station.

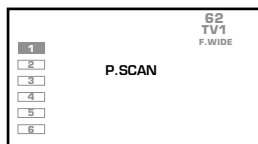

2. To release the preset scanning, press the [PS] button again.

Preset selection

1. Press the [BND] button to select TV1 or TV2.
2. Press the [▲] or [▼] button to select the preset channel.
The station in the channel which is stored in the memory is now tuned in.

Checking out the channels

1. Press the [DISP] button.
The current channel is displayed on the screen.
Press the [DISP] button again to turn off the channel display.

Selecting the adjustment menu

1. Press the [ADJ] button to display the adjustment menu screen.

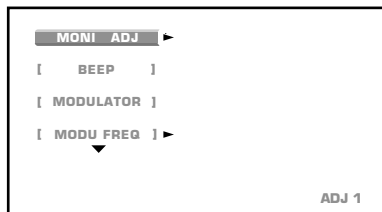

2. Press the [▲] or [▼] button to select the desired adjustment menu.

Adjusting the brightness and tone of color

1. Display the adjustment menu as described in the section, "Selecting the adjustment menu".
2. Press the [▶] button to display the picture quality adjustment screen.
* Hue adjustment is not possible in PAL mode.
* "HUE" and "COLOR" operations are available only when the car is stopped and the parking brake is applied.



3. Press the [▲] or [▼] button to select what is to be adjusted, and then press the [◀] or [▶] button to make the adjustment.
* The pointer which indicates the adjustment position moves one scale increment when initially pushed once.

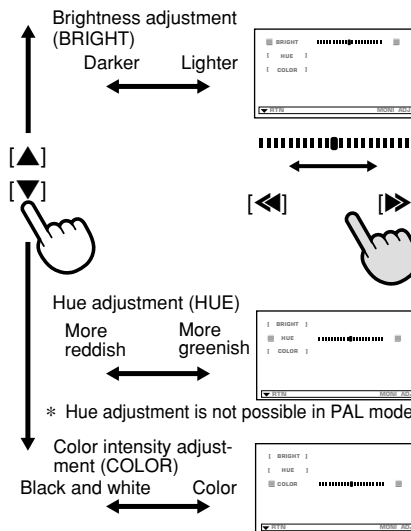

TV Mode Operations

- * Press the [BND] button when all adjustments have been made to return to the adjustment menu screen.
Press the [ADJ] button to return to the normal screen mode.

Setting the beep

- * The sound heard when you make operations is called "beep". The unit can be set up so that it does not produce this beep sound.
- * The factory default setting is "ON".

1. Display the adjustment menu as described in the section, "Selecting the adjustment menu".

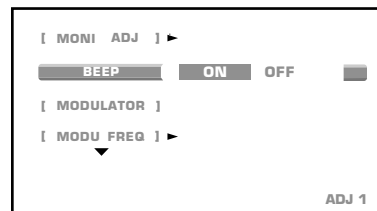

2. Press the [◀] or [▶] button to select a desired mode and set it.
3. Press the [ADJ] button to return to the normal screen mode.

Turning the FM modulator on/off (TB731P/TB732P only)

1. Display the adjustment menu as described in the section, "Selecting the adjustment menu".

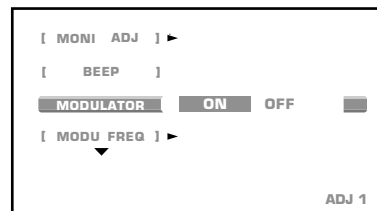

2. Press [◀] or [▶] button to select ON or OFF.
* Press the [ADJ] button when all adjustments have been made to return to the normal screen mode.
* The factory default setting is "ON".

Selecting the FM modulator frequency (TB731P/TB732P only)

1. Display the adjustment menu as described in the section, "Selecting the adjustment menu".

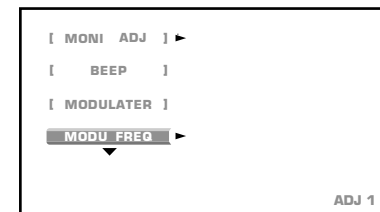

2. Press the [▶] button to display the frequency setting screen.

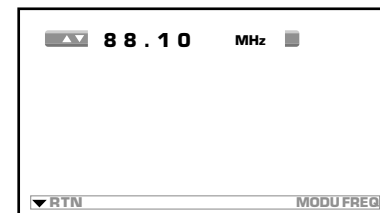

3. Press the [▲] or [▼] button to change frequencies.
• Frequencies can be set in the range 88.1 MHz to 89.9 MHz in 0.2 MHz increments.
• Set the FM modulator frequency to a frequency without a FM broadcast.

- * Press the [BND] button when all adjustments have been made to return to the adjustment menu screen.
Press the [ADJ] button to return to the normal screen mode.
- * The factory default setting is "88.10" MHz.

Selecting VTR system (NTSC/PAL/AUTO)

1. Display the adjustment menu as described in the section, "Selecting the adjustment menu".

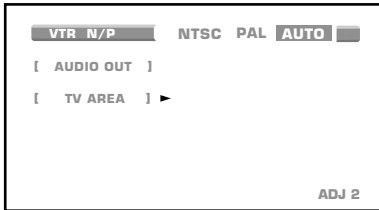

2. Press the [◀] or [▶] button to select NTSC, PAL or AUTO.

- * When [AUTO] is selected, automatic switching between NTSC and PAL may not occur properly. In such cases, use manual selection.
- * Press the [ADJ] button to return to the normal screen mode.
- * The factory default setting is "AUTO".

Setting the audio output sound level

You can adjust an output sound level of audio output terminal (RCA L/R).

1. Display the adjustment menu as described in the section, "Selecting the adjustment menu".

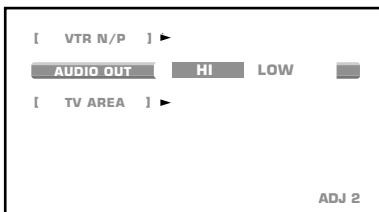

2. Press the [◀] or [▶] button to select a desired mode and set it.
 3. Press the [ADJ] button to return to the normal screen mode.
- * The factory default setting is "HI".

Changing the TV reception area (TB731P only)

* The factory default setting is "OTHERS".

1. Display the adjustment menu as described in the section, "Selecting the adjustment menu".



2. Press the [▶] button to display a TV area selecting screen.
 3. Press the [▲] or [▼] button to select a desired mode and set it.
- * Press the [BND] button when all adjustments have been made to return to the adjustment menu screen.
 - Press the [ADJ] button to return to the normal screen mode.
 - * Any station preset memories are lost when the reception area is changed.

Watching a external device

Refer to the Instruction Manual of the unit concerned for details on operating the external device connected.

Press the [BND] button to select VTR (External Device).

Each time the [BND] button is pressed, the setting is switched in the sequence shown below.

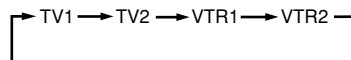

8. TROUBLESHOOTING

- If you think that something has gone wrong with your unit, check out the following points before requesting servicing.

	Problem	Cause	Measure
GENERAL	Power does not turn on. (No sound is produced.)	Fuse is blown.	Replace with a fuse of the same amperage. If the fuse blows again, consult your store of purchase.
		Incorrect wiring.	Consult your store of purchase.
	Nothing happens when buttons are pressed. Display is not accurate.	The microprocessor has malfunctioned due to noise, etc.	Turn off the power, then press the reset button for about 2 seconds with a thin rod. Note: When the reset button is pressed, turn off the ACC power.
			 The Reset button
The remote controller does not work.	Direct rays of the sun fall on the light-receptive part of the remote controller.	When direct rays of the sun fall on the light-receptive part of the remote controller, it may not work.	
	The batteries of the remote controller unit are dead or there is no battery in the remote controller unit.	Check the batteries of the remote controller unit.	

9. SPECIFICATIONS

	Problem	Cause	Measure
TV	The image is not displayed.	The parking brake is not pulled.	Check that the parking brake is applied.
	The display is dark.	The brightness control is too low.	Adjust the brightness properly.
		The operating condition is not good.	The temperature inside the vehicle may be 0°C or less. Set to an appropriate temperature (25°C or so) and check it again.
		The headlight of the vehicle is lit.	The display is made dark at night to prevent the glare (When the headlight of the vehicle is lit in the daytime, the display gets dark).
	The color of the display is light or a shade of color is not good.	The color is not adjusted adequately.	Check that COL and HUE are adjusted properly.
	When the VTR is connected, the image is disturbed.	Improper NTSC/PAL setting	Set the NTSC/PAL properly according to the VTR.
	The image gets unclear.	Bad receiving condition	A radio wave may not reach sufficiently due to obstruction of mountains or buildings. Check it again at a place where a radio wave can be received properly.
	The TV tuner has a double or triple image.	Bad receiving condition	It may be under the influence of radio wave reflected by mountains or buildings. Check it again after changing place or direction.
	The TV tuner has spots or stripes in the image.	Presence of jamming	It may be under the influence from automobiles, streetcar, power cable, neon sign, and so forth. Check it again after changing place.
	There are red, green, and blue points in the display.		This is not a failure, but a phenomenon peculiar to a liquid crystal panel (The LCD panel is produced according to technology with very high precision. Note that, though there are effective pixels of 99.99% or more, pixel missing or normally lit pixels account for 0.01%).

LCD Monitor

Screen size: 7-inch wide type (152 mm Width × 85 mm Height)
 Display method: Transmission type TN liquid crystal display
 Drive method: TFT (thin-film transistor) active matrix driving
 Pixels: 336.960 (1440 × 234)

TV Tuner

Tuning system: PLL synthesizer system
 Reception channels:

- TB731P
 - VHF: CCIR 2 to 12 ch (47 to 230 MHz)
 - NEW ZEALAND 1 to 11 ch (44 to 230 MHz)
 - AUSTRALIA 0 to 11ch (45 to 222 MHz)
 - UHF: CCIR 21 to 69 ch (470 to 862 MHz)
 - NEW ZEALAND 21 to 69 ch (470 to 862 MHz)
 - AUSTRALIA 28 to 69ch (526 to 820 MHz)
- TB732P
 - VHF: 1 to 12 ch (48.5 to 223 MHz)
 - UHF: 13 to 57 ch (470 to 870 MHz)
- TB733W
 - VHF: 2 to 13 ch (54 to 216 MHz)
 - UHF: 14 to 69 ch (470 to 806 MHz)

Antenna input: 75 Ω unbalanced

Input/Output

Video input: 1.0 ± 0.2 Vp-p (input impedance 75 Ω)
 Audio input: 130 ± 60 mVrms (input impedance 45 kΩ or greater)
 Video output: 1.0 V ± 0.2 Vp-p (output impedance 75 Ω)
 Audio output:
 HIGH 230 ± 100 mV (at VTR Input 130 mV)
 LOW 125 ± 50 mV (at VTR Input 130 mV)
 (LOAD RESISTANCE 10 kΩ)

General

Power source voltage: DC13.2 V (10.8 to 15.6 V)
 Ground: Negative
 Current consumption: Less than 2.0 A
 Weight: 1.75 kg
 Dimensions: 178 mm Width × 50 mm Height × 165 mm Depth

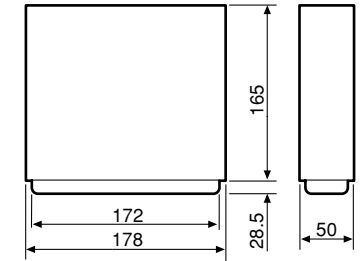

Dimensions of Remote Control Unit:
 44 mm Width × 27.2 mm Height × 110 mm Depth
 Weight of the Remote Control Unit: 50 g

Note:

• Specifications and design are subject to change without notice for further improvement.

1. BEFORE STARTING

1. This set is exclusively for use in cars with a negative ground 12 V power supply.
2. Read these instructions carefully.
3. Be sure to disconnect the battery “⊖” terminal before starting. This is to prevent short circuits during installation. (Figure 1)

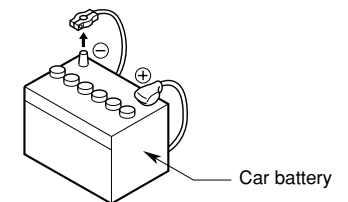

Figure 1

2. PACKAGE CONTENTS

- | | |
|--|------------------------------|
| ① Main unit | ⑤ Remote control unit |
| ② Manuals
Owner's Manual & Installation Manual | ⑥ Battery (SUM3) |
| ③ Connection lead | ⑦ Outer Escutcheon |
| ④ Bag for accessories | |
| Flat head screw (M5 × 8) 4 | |
| Sems hexagonal bolt (M5 × 8) 5 | |
| Electro tap 1 | |
| Hook plate 2 | |
| Cable tie 1 | |
| Rubber cap 1 | |
| Special screw 1 | |

3. GENERAL CAUTIONS

1. Do not open the case. There are no user serviceable parts inside. If you drop anything into the unit during installation, consult your dealer or an authorized Clarion service center.
2. Use a soft, dry cloth to clean the case. Never use a rough cloth, thinner, benzine, or alcohol, etc. For tough dirt, apply a little cold or warm water to a soft cloth and wipe off the dirt gently.

4. CAUTIONS ON INSTALLATION

1. Prepare all articles necessary for installing the main unit before starting.
2. This model is used with the LCD panel slid forwards (shell loading system). On some types of cars, the LCD panel may touch the dashboard or shift stick, in which case it cannot be installed. Check that the set will not hamper operation of the shift stick before choosing the place of installation.(Figure 2)

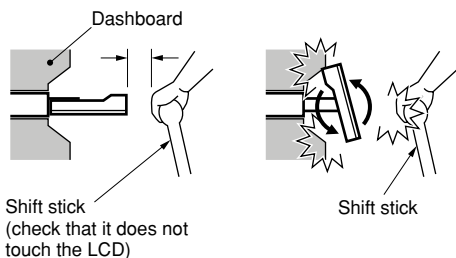

Figure 2

3. Install the unit within 30° of the horizontal plane. (Figure 3)

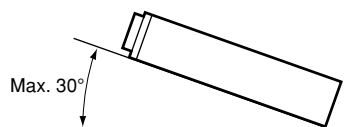

Figure 3

4. If you have to do any work on the car body, such as drilling holes, consult your car dealer beforehand.
5. Use the enclosed screws for installation. Using other screws can cause damage. (Figure 4)

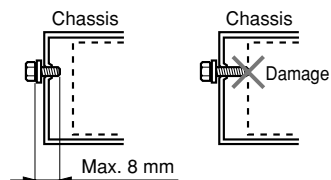

Figure 4

6. The main unit has mounting screw holes for NISSAN (N marks) and TOYOTA (T marks) vehicles. (Figure 5)

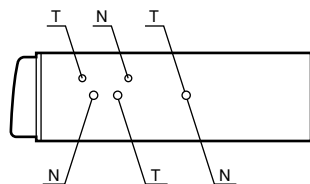

Figure 5

5. INSTALLING THE MAIN UNIT

■ Universal Mount

1. Place the universal mounting bracket into the instrument panel, use a screwdriver to bend each stopper of the universal mounting bracket inward, then secure the stopper as shown in Figure 6.
2. Wire as shown in Section 8.
3. Insert the main unit into the universal mounting bracket until it locks.
4. Mount the outer escutcheon so that all the hooks are locked.

Notes:

- 1) Some car models require special mounting kits for proper installation. Consult your Clarion dealer for details.
- 2) Fasten the front stopper securely to prevent the main unit from coming loose.

• Console opening dimensions

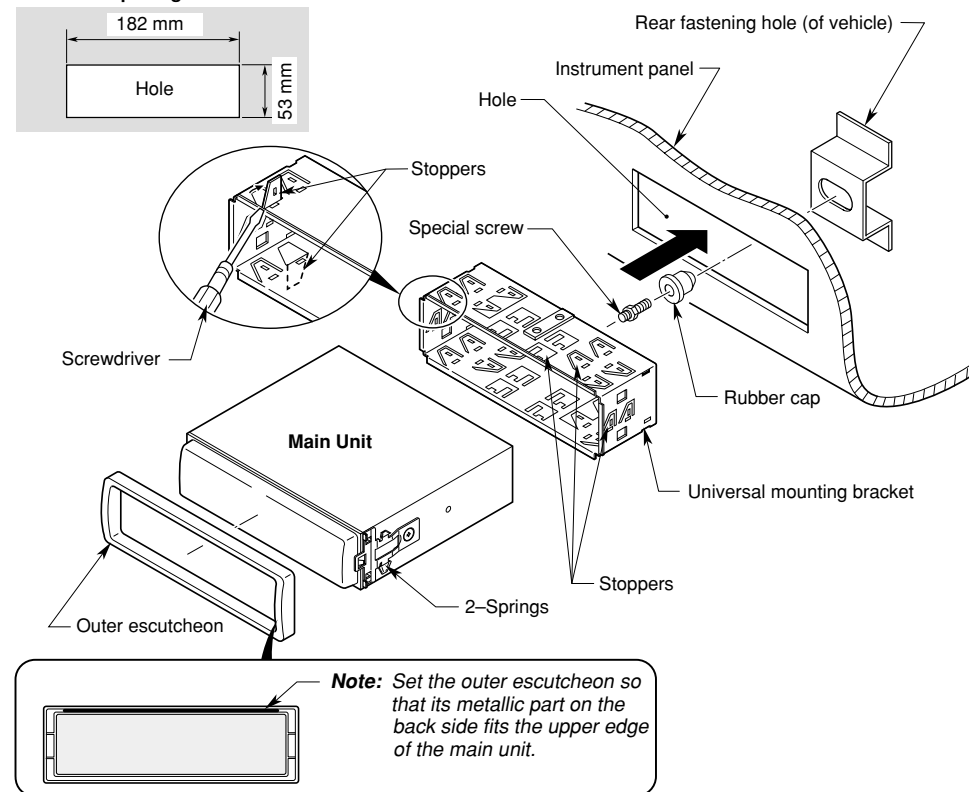
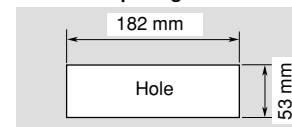

Note: Set the outer escutcheon so that its metallic part on the back side fits the upper edge of the main unit.

Figure 6

Fixed Mount (TOYOTA, NISSAN and other ISO/DIN equipped vehicles)

This unit is designed for fixed installation in the dashboard.

If the vehicle is equipped with a factory-installed radio, install the main unit with the parts and screws marked (*) (Figure 8).

If the vehicle is not equipped with a factory-installed radio, obtain an installation kit to install the main unit in the following procedure.

1. Remove the screws at both sides of the main unit and slide the springs to the direction of arrow and remove them (Figure 7).

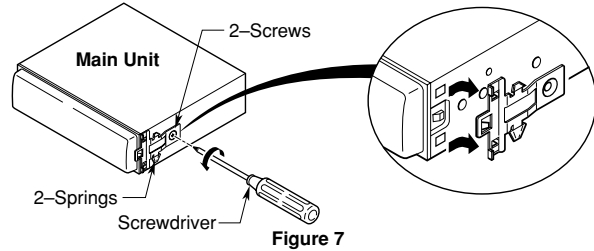

Figure 7

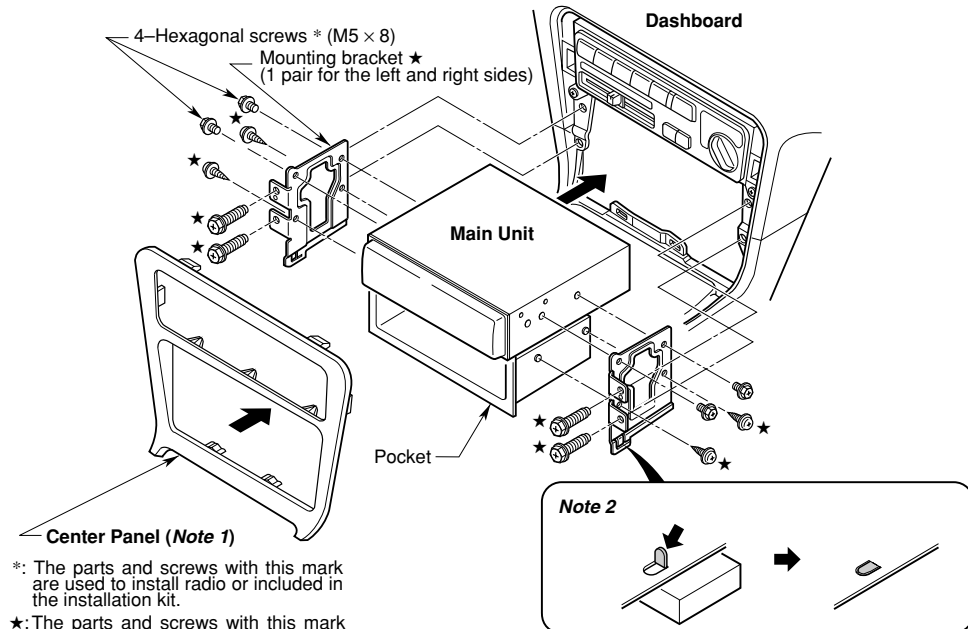

Figure 8

*: The parts and screws with this mark are used to install radio or included in the installation kit.
★: The parts and screws with this mark are originally attached to the vehicle.

Note 1: In some cases, the center panel may require some modification (trimming, filling, etc.).

Note 2: If a hook on the installation bracket interferes with the unit, bend and flatten it with a nipper or a similar tool.

2. Secure the mounting brackets to the chassis as shown in Figure 8. Holes are pre-tapped for TOYOTA and NISSAN vehicles; modification, such as drilling new holes, of the mounting brackets may be required for other models.
3. Wire as shown in Section 7.
4. Secure the unit in the dashboard, and then reassemble the dashboard and the center panel.

6. REMOVING THE MAIN UNIT

1. When the rear of the main unit has been secured with the method shown in Figure 6 unfasten the special screw.
2. Remove the outer escutcheon.
3. Insert the hook plate between the spring and the universal mounting bracket, fit tab (B) of the spring into hole (A) of the hook plate,

then pull the main unit out by the hook plate. (Insert both the right and left edges of the hook plate.) (Figure 9)

Note: Keep the hook plate. You cannot remove the main unit without disengaging the hook plate.

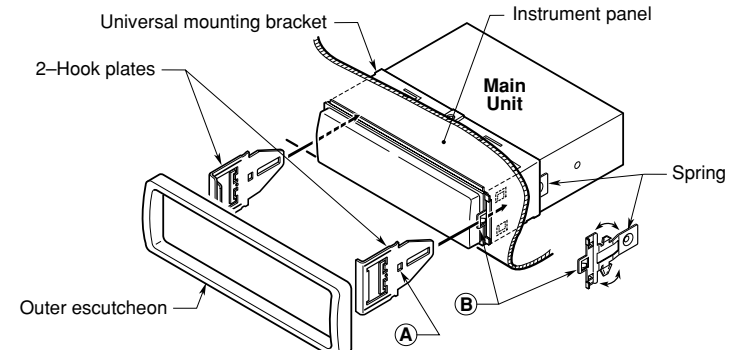

Figure 9

7. CAUTIONS ON WIRING

1. Be sure to turn the power off before wiring.
2. Be particularly careful where you route the wires.
Keep them well away from the engine, and exhaust pipe, etc.
Heat may damage the wires.
3. When connecting the ground lead, fasten the ground lead (black) securely to a clean metal plate on the car. (Figure 10)
If the set is insufficiently grounded, it may not operate or there may be noise.
4. If the fuse should blow, check to see if the wiring is correct.
If it is, replace the fuse with a new one with the same amperage rating as the original.
5. To replace the fuse, remove the old fuse of the power supply lead and insert the new one (3A). (Figure 11)

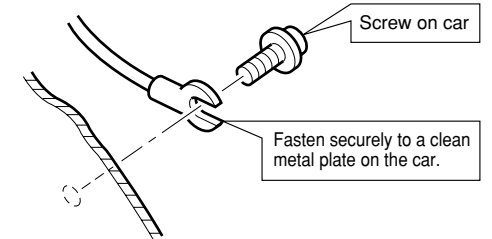

Figure 10

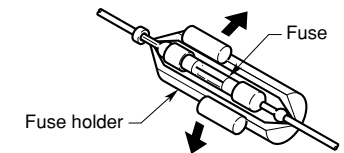
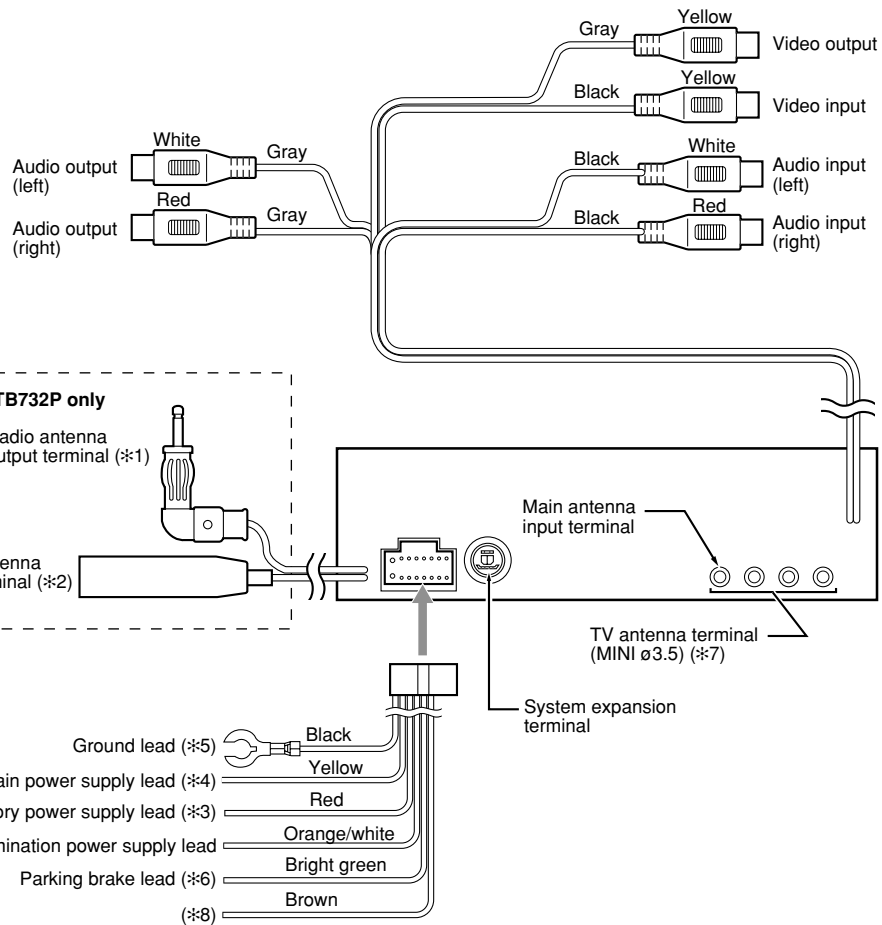

Figure 11

CAUTION

After the connection, fix the lead by a clamp or insulation tape for protection.

8. WIRE CONNECTIONS



- *1: Connect this to the antenna input terminal on the car stereo. (TB731P/TB732P only)
- *2: Connect the vehicle's radio antenna to this. (TB731P/TB732P only)
- *3: Connect to the power supply terminal which can be turned on and off by the ignition switch.
- *4: Connect to the power supply terminal where the power is always supplied regardless of whether the ignition switch is turned on or off.
- *5: Connect securely to the metal part of the vehicle with a screw, etc.

- *6: Connect to the ground lead of the parking brake lamp in the instrument panel.
- *7: There are four antenna terminals: Main and sub. When there is one vehicle side antenna connector, connect it to the main terminal.
- *8: It is not connected.

Notes:

- The unit cannot be used on its own. It must be used in combination with the car stereo.
- The main power cord (yellow) must be connected to the prescribed location. Malfunctioning may occur if it is connected together with other cords at the same location.

■ RCA Extension Cable

- Do not remove the insulating cap of the RCA extension cable which is not going to be connected to prevent it from short-circuit.
- Fix the RCA extension cable with insulating tape so that the connection part is not going to be loose.

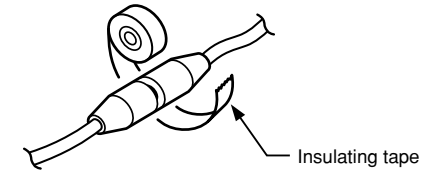

■ Concerning the illumination power supply (automatic reduced light function)

When the illumination power supply lead has been connected, the picture brightness is automatically reduced when the vehicle's light is turned on at night.

■ Connecting the parking brake lead

Connect the lead to parking brake lamp earth in the meter panel.

Notes:

- Connecting the parking brake lead to lamp earth allows you to watch TV when the parking brake is engaged.
- When the parking brake lead is not connected, the monitor will stay off.

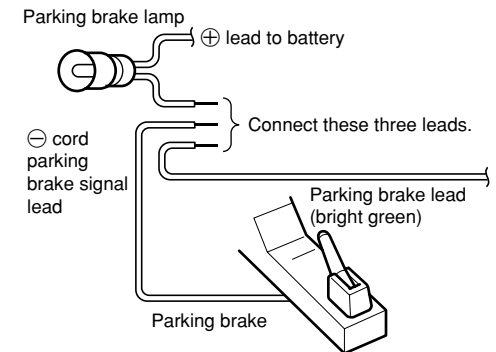

9. SAMPLE SYSTEMS

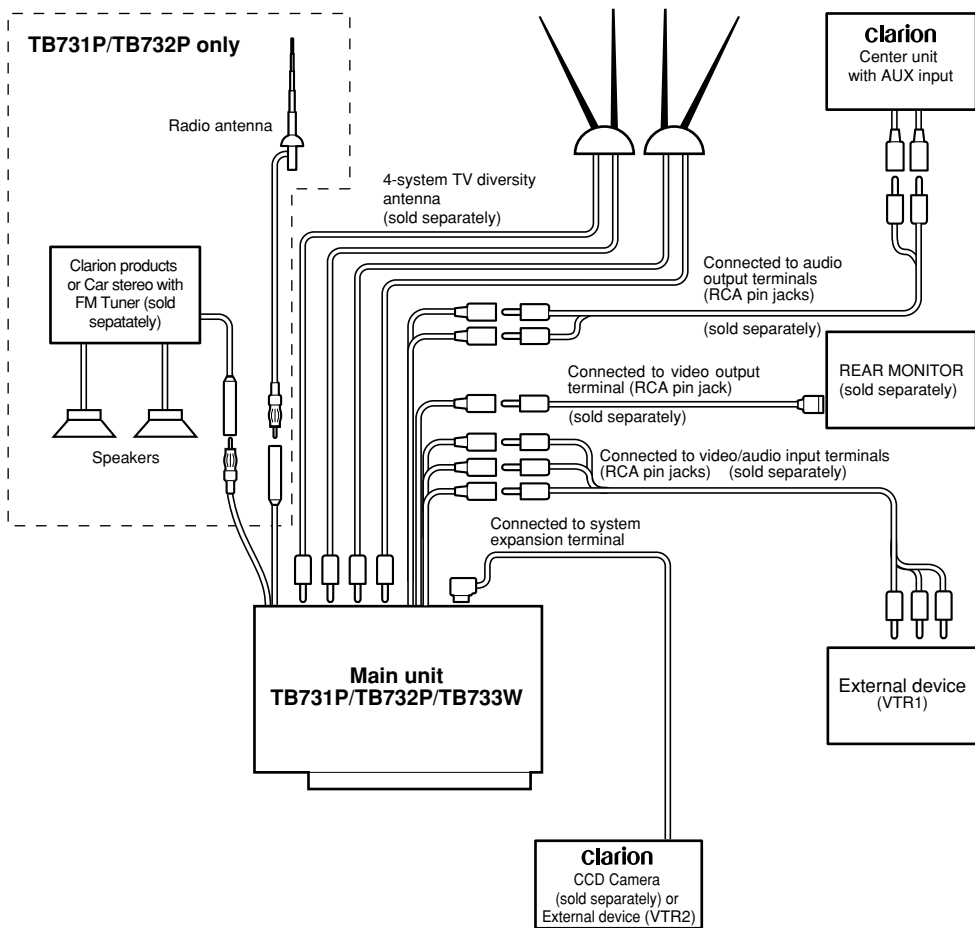

Notes:

- For details on the connecting terminals, refer to the section on wire connections (page 26).
- A External device can be connected to the system expansion terminal using the CCA-389 conversion cable.

Parts sold separately for connections

■ TV antennas (antennas for added pictures)

Model number	Application	No. of systems	Remarks
ZCP-104	TV antenna for vehicles	4	Film type antenna with booster
ZCA-404	TV antenna (diversity) for vehicles	4	1 set of left and right antennas (retractable)
ZCP-100	TV antenna (diversity) for vehicles	4	With booster
ZCB-303	TV antenna (diversity) for vehicles	2	

* Various conversion adaptors, extension cords, antennas and other parts are available in addition to what is listed above. For details, consult your dealer or your nearest Clarion service outlet.

Free Manuals Download Website

<http://myh66.com>

<http://usermanuals.us>

<http://www.somanuals.com>

<http://www.4manuals.cc>

<http://www.manual-lib.com>

<http://www.404manual.com>

<http://www.luxmanual.com>

<http://aubethermostatmanual.com>

Golf course search by state

<http://golfingnear.com>

Email search by domain

<http://emailbydomain.com>

Auto manuals search

<http://auto.somanuals.com>

TV manuals search

<http://tv.somanuals.com>