

clarion

VS738

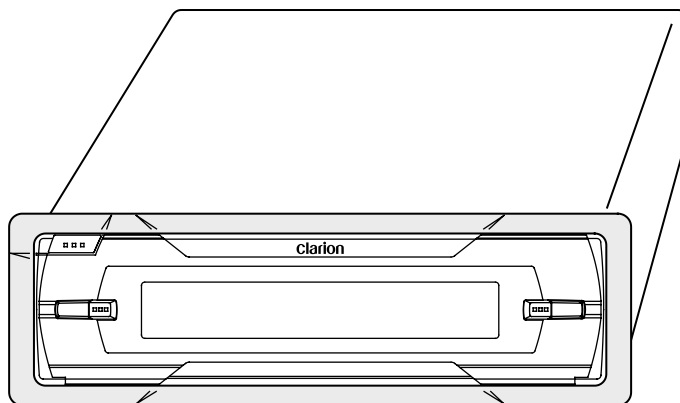
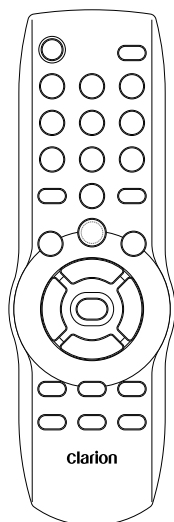

DIGITAL MEDIA P L A Y E R

OWNER'S MANUAL

INSTALLATION GUIDE

BEDIENUNGSHANDBUCH

INSTALLATIONSANLEITUNG

MODE D'EMPLOI

GUIDE D'INSTALLATION

MANUALE DELL'UTENTE

GUIDA PER L'INSTALLAZIONE

MANUAL DEL USUARIO

GUÍA DE INSTALACIÓN

GEBRUIKS- EN

INSTALLATIEHANDLEIDING

BRUKSANVISNING

INSTALLATIONSGUIDE

MANUAL DO PROPRIETÁRIO

GUIA DE INSTALAÇÃO

Features

• Features

Compatible with PAL DVD (Video CD) and NTSC DVD (Video CD)

This player can play discs recorded in either PAL or NTSC format.

- A single LSI chip now integrates all major DVD playback circuit functions including the MPEG2 decoder, video D/A converter, and audio decoders.
- L/R stereo analog audio outputs (RCA) for connection to existing head unit aux inputs. Video output is composite video (RCA).
- Supplied remote handles multi-function software (multi-language audio-track/subtitle, multi-angle), plus all basic functions.

• Use This Product Safely

When Driving

Keep the volume level low enough to be aware of road and traffic conditions.

When Washing the Car

Do not expose the product to water or excessive moisture. This could cause electrical shorts, fire or other damage.

When Parked

Parking in direct sunlight can produce very high temperatures inside your vehicle. Give the interior a chance to cool down before starting playback.

Use the Proper Power Supply

This product is designed to operate with a 12 volt DC, negative ground battery system (the regular system in a normal car).

Protect the Disc Mechanism

Avoid inserting any foreign objects into the slot of this player.

Failure to observe this may cause malfunction due to the precise mechanism of this unit.

Use Authorized Service Centre

Do not attempt to disassemble or adjust this precision product. Please refer to the Service Centres list included with this product for service assistance.

Installation

The unit should be installed in a horizontal position with the front end up at a convenient angle, but not more than 30°.

• Dolby Digital

Manufactured under license from Dolby Laboratories.

“Dolby” and the double-D symbol are trademarks of Dolby Laboratories. Confidential Unpublished Works. ©1992-1997 Dolby Laboratories, Inc. All rights reserved.



Contents

Safety Information	3
Disc Notes	4
Installation	6
DIN Front-mount (Method A)	6
DIN Rear-mount (Method B)	7
Installation Bracket-mount (Method C)	8
Using the Detachable Front Panel	9
Electric Connection	10
Remote Control	11
Preparing the Remote Control Unit for Use	12
Inserting a DVD/VCD/CD	12
Removing a Disc	12
Basic Operation	13
On-screen Display Function	14
Multiple Language Audio Function for DVD	15
Menu Function	15
Multilingual Subtitles (DVD Only)	15
Multi-angle Function (DVD Only)	15
MP3 Disc Replay	16
Special Functions	16
Initial Setup	17
General Setup	17
Speaker Setup	19
Audio Setup	19
Preferences Setup	20
Specifications	23



Safety Information

• Caution

- THIS MOBILE DVD PLAYER IS A CLASS I LASER PRODUCT. HOWEVER THIS MOBILE DVD PLAYER USES A VISIBLE/ INVISIBLE LASER BEAM WHICH CAN CAUSE HAZARDOUS RADIATION EXPOSURE IF DIRECTED.
- BE SURE TO OPERATE THE MOBILE DVD PLAYER CORRECTLY AS INSTRUCTED.
- USE OF CONTROLS OR ADJUSTMENTS OTHER THAN THOSE SPECIFIED HEREIN MAY RESULT IN HAZARDOUS RADIATION EXPOSURE.
- DO NOT OPEN COVERS AND DO NOT REPAIR YOURSELF. REFER SERVICING TO QUALIFIED PERSONNEL.

• Warning

- TO REDUCE THE RISK OF FIRE OR ELECTRIC SHOCK, DO NOT EXPOSE THIS EQUIPMENT TO RAIN OR MOISTURE.
- TO REDUCE THE RISK OF FIRE OR ELECTRIC SHOCK, AND ANNOYING INTERFERENCE, USE ONLY THE RECOMMENDED ACCESSORIES.
- THIS DEVICE IS INTENDED FOR CONTINUOUS OPERATION.

This product incorporates copyright protection technology that is protected by method claims of certain U.S. patents and other intellectual property rights owned by Macrovision Corporation and other rights owners. Use of this copyright protection technology must be authorized by Macrovision Corporation, and is intended for home and other limited viewing uses only unless otherwise authorized by Macrovision Corporation. Reverse engineering or disassembly is prohibited.

• Region Management Information

- This Mobile DVD Player is designed and manufactured to respond to the Region Management Information that is recorded on a DVD disc. If the Region number described on the DVD disc does not correspond to the Region number of this Mobile DVD Player, this Mobile DVD Player cannot play this disc.
- **The Region number for this product is "2".**

Disc Notes

• Disc Formats Supported by This Player



DVD
12 cm disc/8 cm disc
(Single-sided disc only)



Video CD
12 cm disc/8 cm disc



CD/CD-R/RW, MP3
12 cm disc/8 cm disc

• Discs Which Cannot Be Played with This Player

- DVD-ROM
- DVD-R/DVD-RW/DVD-RAM
- CD-ROM
- Photo CD
- CD-DA with Copy Protection
- DVDs with a Region number other than "2" and "ALL"

• Disc Handling

- Dirt, dust, scratches and warped discs can cause incorrect function.
- Do not place stickers or make scratches on discs.
- Do not warp discs.
- A disc should always be kept in its case when not in use to prevent it from damage.
- Do not place discs in the following places:
 1. Direct sunlight.

2. Dirty, dusty and damp areas.
3. Near car heaters.
4. On the seats or dashboard.

• Disc Cleaning

Use a dry soft cloth to wipe the surface. If the disc is quite dirty, use a soft cloth slightly moistured with isopropyl (rubbing) alcohol. Never use solvents such as benzene, thinner or conventional record cleaners as they may mar the surface of the disc.

• Note:

A disc may become somewhat scratched (although not enough to make it unusable) depending on how you handle it and conditions in the usage environment. Note these scratches are not an indication of any problem with the player.

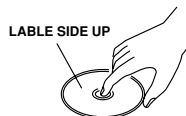



Disc Notes

• Preparing New Discs with Rough Spots

A new disc may have rough edges on its inside and outside edges. If a disc with rough edges is used, the proper setting will not be performed and the player will not play the disc. Therefore, remove the rough edges in advance by using a ball-point pen or pencil as shown below. To remove the rough edges, press the side of the pen or pencil against the inside and outside edges of the disc.

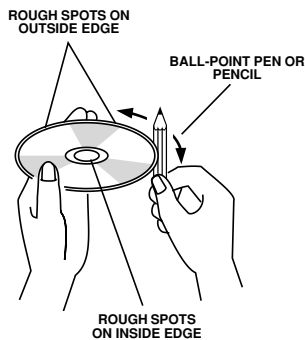

Installation

• Notes:

- Choose the mounting location where the unit will not interfere with the normal driving function of the driver.
- Before finally installing the unit, connect the wiring temporarily and make sure it is all connected up properly and the unit and the system work properly.
- Use only the parts included with the unit to ensure proper installation. The use of unauthorized parts can cause malfunctions.
- Consult with your nearest dealer if installation requires the drilling of holes or other modifications of the vehicle.
- Install the unit where it does not get in the driver's way and cannot injure passengers if there is a sudden stop, like an emergency stop.
- If the installation angle exceeds 30° from horizontal, the unit might not give optimum performance.
- Avoid installing the unit where it will be subject to high temperature, such as from the heater, or where it will be subject to dust, dirt or excessive vibration.

• DIN Front/Rear-mount

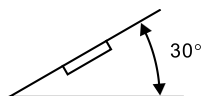

This unit can be properly installed either from the "Front" (conventional DIN Front-mount) or "Rear" (DIN Rear-mount installation, utilizing threaded screw holes at the sides of the unit chassis). For details, refer to the following illustrated installation methods.

- DIN Front-mount (Method A)

Installing the unit

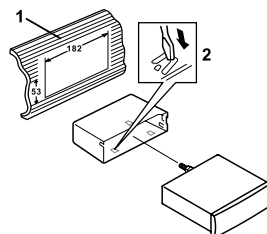

1. Dashboard
2. Holder

After inserting the holder into the dashboard, select the appropriate tabs according to the thickness of the dashboard material and bend them inwards to secure the holder in place.

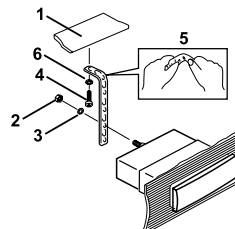

1. Dashboard
2. Hex nut (M5)
3. Spring washer
4. Hex washer head tapping screw (M5x18)
5. Strap
6. Plain washer

Be sure to use the strap to secure the back of the unit in place. The strap can be bent by hand to the desired angle.

Installation

Removing the unit

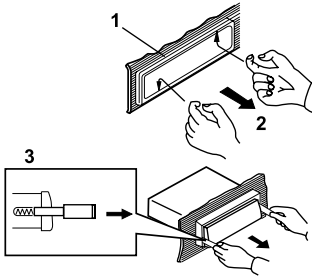

1. Frame
2. Insert fingers into the groove in the front of frame and pull out to remove the frame. (When re-attaching the frame, point the side with the groove downwards and attach it.)
3. Lever
Insert the levers supplied with the unit into the grooves at both sides of the unit as shown in figure until they click. Pulling the levers makes it possible to remove the unit from the dashboard.

- DIN Rear-mount (Method B)

Installation using the screw holes on the sides of the unit.

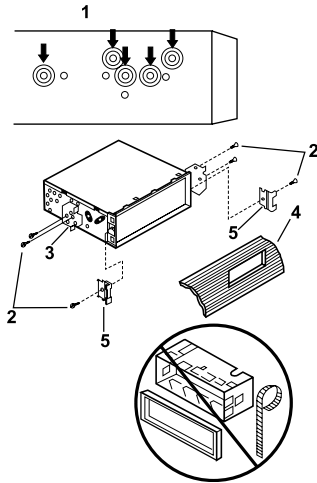

Fastening the unit to the factory radio mounting bracket.

1. Select a position where the screw holes of the bracket and the screw holes of the main unit become aligned, and tighten the screws at 2 places on each side. Uses truss head machine screws (M4×6), depending on the shape of the screw holes in the bracket.
2. Truss head machine screw (M4×6)
3. Factory radio mounting bracket
4. Dashboard or console
5. Hook (Remove this part)

• Note:

The mounting box, outer trim ring, and half-sleeve are not used for method B installation.



Installation

- Installation Bracket-mount (Method C)

If installation of the DVD player in a DIN slot is impossible or undesirable, it can be installed in alternative installation locations using the supplied mounting brackets.

1. Use flat head machine screws (M5×5) to fix the installation brackets to the unit (on both sides) in the desired direction.
2. Align the unit on the place of installation and secure it with Hex washer head tapping screws (M5×18).

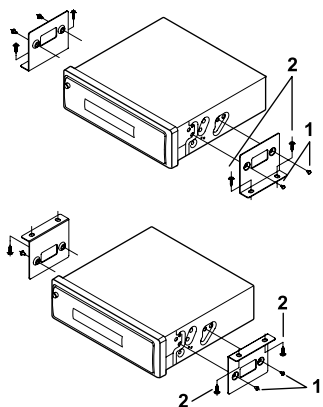

1. Flat head machine screws (M5×5)
2. Hex washer head tapping screws (M5×18)



Using the Detachable Front Panel

• To Detach the Front Panel

1. Press the **OPEN** button, then the front panel will be folded down.

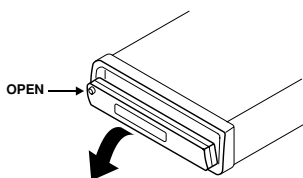

2. Remove the front panel by pulling its middle-hand side outward.

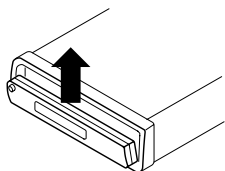

3. For safekeeping, store the front panel in the supplied protective case immediately after being removed.

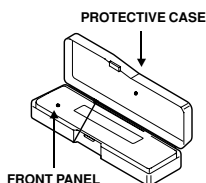

4. Push the front metal plate into the main body. A 'click' sound will be heard.

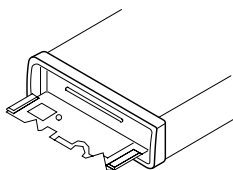

• To Re-install the Front Panel

1. Push the front panel into the main body. A 'click' sound should be heard.

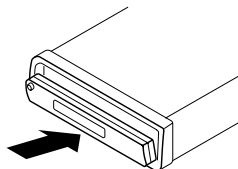

2. Note that if the front panel fails to lock in position properly, control buttons may not function and the LCD display may not light some segments. In this case, press the **OPEN** button and then re-install the front panel again.

• Precautions During Handling

1. Do not drop the front panel.
2. Do not put pressure on the display or control buttons when detaching or re-installing the front panel.
3. Do not touch the contacts on the front panel or on the main unit body. It may result in poor electrical contact.
4. If dirt or foreign substances adhere to the contacts, this can be removed with a clean and dry cloth.
5. Do not expose the front panel to high temperatures or direct sunlight.
6. Prevent any volatile agents (e.g. benzene, thinner, or insecticides) from touching the surface of the front panel.
7. Do not attempt to disassemble the front panel.

Electric Connection

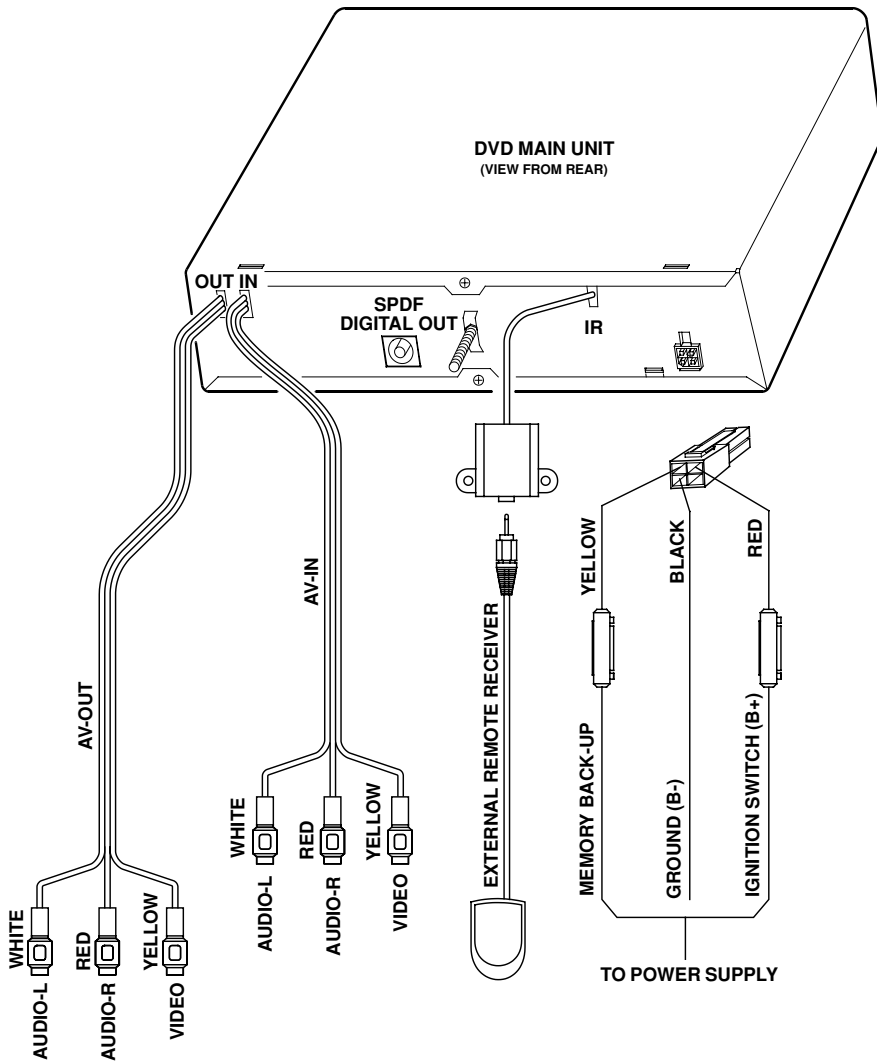



Remote Control

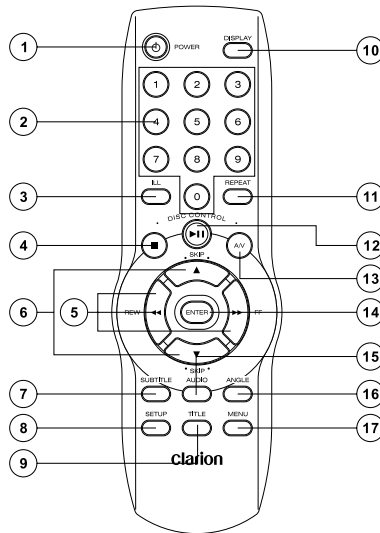

1. **⏻ POWER** Button for switching the equipment ON or OFF.
2. **0-9** Numerical buttons.
3. **ILL/GOTO** Button for adjusting the brightness of the VFD Display, or performing time search during play.
4. **■** Press to stop playback.
5. **⏮/⏭** Fast forward **⏭** and fast reverse **⏮** buttons.
6. **▲/▼** Button for advancing to the start of the next section **▲** or for returning to the previous section **▼**. In the menu mode, these buttons control the cursor.
7. **SUBTITLE** Selects subtitles on DVD discs with multilingual subtitle functions.
8. **SETUP** Calls the SETUP MENU.
9. **TITLE** Opens the title contained on the DVD disc.
10. **DISPLAY** Button for hiding or displaying the status line during play.
11. **REPEAT** Switches between repeat modes.
12. **⏸** Button for pausing and restarting play.
13. **A/V** Switches between DVD player and external AUDIO/VIDEO.
14. **ENTER** Button for confirming sections/chapters selected using the number or cursor buttons in combination with the screen.
15. **AUDIO** Selects the audio soundtrack on DVDs with multilingual audio functions.
16. **ANGLE** Selects the camera angle on DVDs with multi-angle function.
17. **MENU** Displays the DVD's main menu.

Note: The **⏮**, **⏭**, **DISPLAY** and **ANGLE** buttons may also be assigned to special functions (see "Special Functions").

Preparing the Remote Control Unit for Use

• Inserting the Batteries

1. Open the battery compartment cover.
2. Insert the new batteries. Make sure that the positive and negative poles of the battery are positioned as show inside the battery compartment.
3. Close the battery compartment.
4. Batteries required: two AAA batteries.

• Using the Remote Control

Point the remote control towards the player front face IR mark (remote control signal receiver).

Operation angle: About $\pm 30^\circ$ in front of the IR mark.

To prevent damage to the unit, be sure to follow the connection diagram (page 10).

• Inserting a DVD/VCD/CD

1. Turn the vehicle's ignition key to the ACC position.
2. Press the **POWER** button (1).
3. Press the **OPEN** button (2) so that the front panel opens slowly forward.

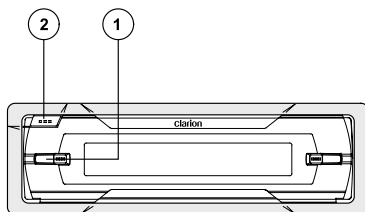

• Removing a Disc

1. Press the **OPEN** button (2). Let the panel fully fold down, then press the **EJECT** button (3) to eject the disc.
2. Remove the disc and close the front panel.

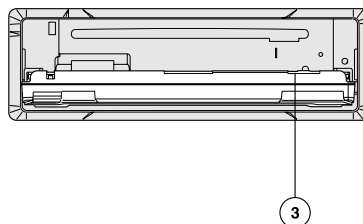

Basic Operation

• Stop Play

- Briefly press the **■ STOP** button to stop playback, and press the **▶▶ PLAY** button to continue normal play.
- Press the **■ STOP** button twice. The player will stop and return to the first section or chapter.

• Fast Forward/Fast Reverse

- Press **▶▶ FF** or **◀◀ REW** during play.
- Each time the button is pressed, the speed of the fast forward/reverse changes as follow:
- **DVD/VCD/CD/MP3**

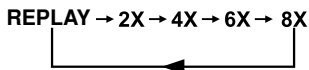

• Skipping a Section

Press the skip buttons, **▲/▼**, during play. The **▲** button takes you to the next section, while the **▼** button returns you to the previous section.

Note: For some VCD2.0 discs (PBC-playback), the **▲/▼** buttons may not function.

• Pause (Still Picture)

Press **▶▶ PLAY** during play.

Press **▶▶ PLAY** again to return to normal play.

• Repeat

Press the **REPEAT** button to select a repeat mode as follows:



- DVD/CD Disc

1. Continuously repeats the current chapter/section, when REPEAT 1 mode has been selected.
2. Select the REPEAT mode to continuously repeat all chapters/sections on the disc.
3. When REPEAT OFF mode has been selected, the VFD display will no longer show REPEAT or REPEAT 1.

- VCD

The repeat function is not available for VCD2.0 (with PBC).

• ILL (Illumination)

- Press the **ILL** button to adjust the illumination of the VFD display in the following sequence. Selecting a higher level will increase the brightness of the VFD display.

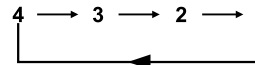

Notes:

This function is only active in the stop status.

- **GOTO:** Press **ILL** during playback to enter the GOTO mode.
- **DVD:** Press **ILL** once, the screen will display:

TITLE 01/04 CHAPTER 001/026

Press **ILL** twice:

TITLE 01/04 TIME _:_:



Basic Operation

- Use the 0-9 keys to input the TITLE/CHAPTER, or hh:mm:ss to which you want to jump. Use ◀ or ▶ to select TITLE/CHAPTER/TIME input. Use **ENTER** to execute jumping.
- CD/VCD: Press **ILL** once to display:
GOTO --:--
- Use the 0-9 keys to input the mm:ss from where you want to start playback. Note that the input time must be less than the total time of the currently playing track.
- The GOTO function is unavailable for MP3 playback.

• Reset

The reset button is located on the housing, and must be pressed with either a ballpoint pen or a thin metal object. The reset button is to be activated for the following reasons:

- After initial installation of the unit when all wiring is completed.
- If the function buttons do not operate.
- If an error symbol is shown on the display.

• Open

Press the **OPEN** button to open the front panel.

• Remote Sensor (IR)

Point the remote control at the IR sensor for receiving the remote control signals.

• Turn Off the Player

Press the **POWER** button on the front panel, or press **POWER** on the remote control unit.

• On-screen Display Function

Press the **DISPLAY** button during play in order to display the contents of the inserted disc on the screen.

Example:

- DVD

1. Press **DISPLAY** for the first time:

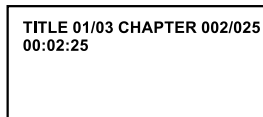

Title Number, Total Title Number, Chapter Number and Total Chapter Number of the Title on the disc currently being played will be shown on the display, along with the elapsed time.

2. Press **DISPLAY** for the second time:

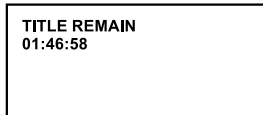

3. Press **DISPLAY** for the third time:



4. Press **DISPLAY** for the fourth time:

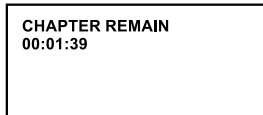



Basic Operation

5. Press **DISPLAY** for the fifth time. The message on the screen will be cleared.

- VCD (with PBC Off)/CD

Each time the **DISPLAY** button is pressed, the screen display changes in the following order:

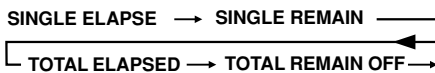

- MP3

Each time the **DISPLAY** button is pressed, the screen display changes as follows:

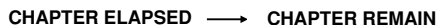

• Multiple Language Audio Function for DVD

- Press the **AUDIO** button during play. Each time the button is pressed, the number of the replay language changes in sequence.

Notes:

- The language numbers vary from one disc to another. Only one language is available on some discs.
- When no different language sound track has been recorded, will be displayed at the screen left top corner.
- **For VCD/CD:** Press the **AUDIO** button during play. It is possible to switch the sound between monaural and stereo sound.

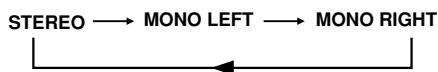

• Menu Function

Title Menu

If a DVD contains multiple titles, the title with which replay should start can be chosen from the title menu.

1. Press the **TITLE** button during play. The title menu is displayed.
2. Press the cursor button shown on the screen, select the preferred title using the cursor buttons and confirm by pressing the **ENTER** button.

• Multilingual Subtitles (DVD Only)

- Press the **SUBTITLE** button during play. Each time the button is pressed, the number of the subtitle language changes in sequence.

Notes:

- The language numbers vary from one disc to another. Only one language is available on some discs.
- When no different subtitle language has been recorded, will be displayed at the screen left top corner.

• Multi-angle Function (DVD Only)

- Press the **ANGLE** button during play. Each time the button is pressed, the angle number changes in sequential order.

Notes:

- The camera angle numbers vary from one disc to another.
- This function is only available for discs having scenes recorded at different angles.
- When no other angle has been recorded, will be displayed at the screen left top corner.

MP3 Disc Replay

- **Supported CD-R/RW**

- **Standards:**

- Disk at once
 - Track at once

- **Supported File Formats:**

- ISO9660, level 1 and level 2
 - Joliet
 - Romeo

- **File System:**

- Max. 8 levels of folders
 - 31 files in each folder
 - Max. 255 folders
 - Max. 255 files

- **Supported Bit Rates:**

- @fs = 32, 44.1, 48, 96 kHz
 - 32 kbit/s – 320 kbit/s

- **Supported ID3V1 Tags:**

- Song name: 30 characters
 - Artist: 30 characters

- **Supported ID3V2 Tags:**

- Song name: 30 Characters
 - Artist: 30 Characters

Example:

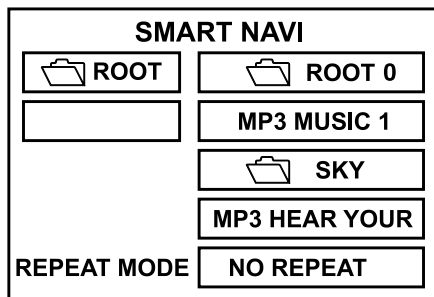

- Use ▲, ▼, ◀ and ▶ to select an item or folder, then press the **ENTER** or **PLAY** button.
- Pressing the **REPEAT** button repeatedly can select three kinds of play modes.
REP-ONE: Plays the same song over and again.

FOLDER REPEAT: Plays all songs in the current directory in sequence, over and again.

NO REPEAT: Plays all songs in the current directory once.

During playback, use ▲/▼ to skip an item ahead or back.

◀◀: Fast rewind, ▶▶: Fast forward.

Note:

The folder cannot be selected during playback. This can only be done after pressing the ■ **STOP** button. During play, the screen will display the MP3-ID3 instead of REPEAT MODE. In this case, it only displays the song name and artist.

- **Special Functions**

- Volume, color, contrast and brightness can be adjusted when in the stop mode.
- **ANGLE:** Selects the volume, color, contrast and brightness:
◀◀: Softer/Weaker
▶▶: Louder/Stronger
- **DISPLAY:** Returns to normal values (except for volume).

Notes:

- For MP3 discs, the above modes cannot be adjusted.
- When the total value of the contrast and brightness is 29, further increase is impossible.
- Do not select excessively high values for the contrast and brightness.

Initial Setup

• Initial Setup

SETUP – MAIN PAGE

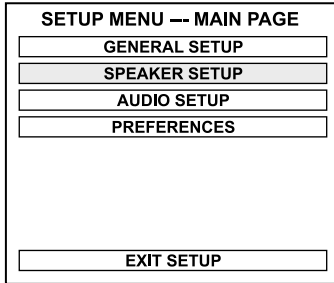

Press **SETUP** in the stop mode. (Press the **■ STOP** button twice to ensure the player is in the stop mode.)

1. The initial SETUP MENU is displayed.
2. Select the preferred item by using the **▲/▼** buttons.
3. Press the **ENTER** button.

I. GENERAL SETUP

This setup page includes all the items for TV display & Audio output setup. For details, please refer to General Setup Menu.

II. SPEAKER SETUP

This is to activate the audio output from DOLBY AC3 5.1 DOWNMIX to the 2-channel mode. Please refer to Speaker Setup Menu.

III. AUDIO SETUP

This setup page includes all the items for AUDIO setup. Please refer to Audio Setup Menu.

IV. PREFERENCES

This setup page includes all the configuration items for supported features. For details, please refer to Preferences Setup Menu.

• General Setup

SETUP – GENERAL – TV DISPLAY

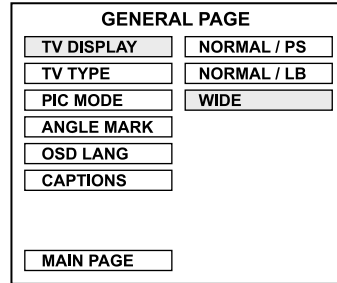

VIDEO MATERIAL	TV SCREEN			
	4:3			WIDE (16:9)
	NORMAL	PAN SCAN	LETTER BOX	

• TV Display Setup

This is to select the appropriate TV aspect ratio (4:3 or 16:9) according to the connected TV set.

- **NORMAL/PS** (for 4:3 TV)
Playback in the PAN SCAN style.
(If connected to a wide-screen TV, the left and right edges are cut off.)
- **NORMAL/LB** (for 4:3 TV)
Playback in Letterbox style.
(If connected to a wide-screen TV, black bands appear at top and bottom of the screen.)
- **WIDE** (for 16:9 TV)
Select this when a wide-screen TV set is connected.

General Setup

SETUP – GENERAL – TV TYPE

GENERAL PAGE	
TV DISPLAY	
TV TYPE	MULTI
PIC MODE	NTSC
ANGLE MARK	PAL
OSD LANG	
CAPTIONS	
MAIN PAGE	

- **TV Type Setup**
 - This player can play discs recorded in either PAL or NTSC format.
 - Select the NTSC format, when an NTSC TV is connected.
 - Select PAL format, when a PAL TV is connected.
 - With MULTI format, the TV output format will automatically change according to the DVD disc format.

SETUP – GENERAL – PIC MODE

GENERAL PAGE	
TV DISPLAY	
TV TYPE	
PIC MODE	AUTO
ANGLE MARK	HI-RES
OSD LANG	N-FLICKER
CAPTIONS	
MAIN PAGE	

- **PIC Mode Setup**
 - With AUTO, the player PIC MODE will depend on DVD disc.
 - Select HI-RES format for the best image resolution.
 - Select N-FLICKER format to suppress picture noise.

SETUP – GENERAL – ANGLE MARK

GENERAL PAGE	
TV DISPLAY	
TV TYPE	
PIC MODE	
ANGLE MARK	ON
OSD LANG	OFF
CAPTIONS	
MAIN PAGE	

- **ANGLE MARK Display Setup**

If it is set to ON, when a multi-angle DVD disc is playing,  (the angle mark) will appear on the screen; if set to OFF, the mark will not appear.

SETUP – GENERAL – OSD LANG

GENERAL PAGE	
TV DISPLAY	
TV TYPE	
PIC MODE	ENGLISH
ANGLE MARK	FRENCH
OSD LANG	GERMAN
CAPTIONS	ITALIAN
	DANISH
	SPANISH
MAIN PAGE	

- **OSD LANG Type Setup**

Select the preferred OSD language by using the ▲/▼ buttons.

Speaker Setup

SETUP – GENERAL – CAPTIONS

GENERAL PAGE	
TV DISPLAY	
TV TYPE	
PIC MODE	
ANGLE MARK	
OSD LANG	
CAPTIONS	ON
	OFF
MAIN PAGE	

• Captions Setup

Activate the CAPTIONS feature by selecting ON. Release this feature by selecting OFF.

• Speaker Setup

SETUP – SPEAKER – DOWNMIX

SPEAKER SETUP PAGE	
DOWNMIX	LT / RT
	STEREO
MAIN PAGE	

• DOWNMIX Setup

This is to switch the audio output from DOLBY AC3 5.1 DOWNMIX to 2-channel mode.

Select the preferred SPEAKER connection by using the cursor buttons.

- Select LT/RT to activate the Dolby surround compatible output.
- Select STEREO to activate the normal stereo mode.

• Audio Setup

SETUP – AUDIO – SPDIF

DOLBY DIGITAL SETUP	
SPDIF	OFF
OP MODE	ON
DUAL MONO	
DRC	
LPCM OUT	
MAIN PAGE	

• SPDIF Setup

Turns the SPDIF optical output ON/OFF.

SETUP – AUDIO – OP MODE

DOLBY DIGITAL SETUP	
SPDIF	
OP MODE	LINE MODE
DUAL MONO	
DRC	
LPCM OUT	
MAIN PAGE	

• OP Mode

There is only one operating mode for the Dolby Digital decoder: LINE MODE.

Preferences Setup

SETUP – AUDIO – DUAL MONO

DOLBY DIGITAL SETUP	
SPDIF	
OP MODE	
DUAL MONO	STEREO
DRC	CH1 MONO
LPCM OUT	CH2 MONO
	MIX MONO
MAIN PAGE	

• Dual Mono

The Dual mono reproduction only process for Dolby Digital program with 1+1 Audio code mode.

STEREO: Reproduces 1+1 program CH1 for left channel, CH2 for right channel.

CH1 MONO: Reproduces CH1 channel in both Left/Right output.

CH2 MONO: Reproduces CH2 channel in both Left/Right output.

MIX MONO: Reproduces CH1+CH2 in both Left/Right output.

SETUP – AUDIO – DRC

DOLBY DIGITAL SETUP		
SPDIF		
OP MODE		
DUAL MONO		
DRC		
LPCM OUT		
MAIN PAGE		

• DRC-Dynamic Range Control

Select DRC to adjust the dynamic range of a Dolby Digital encoded program. There are 8 steps between full compression and no compression (OFF).

SETUP – AUDIO – LPCM OUTPUT

DOLBY DIGITAL SETUP	
SPDIF	
OP MODE	
DUAL MONO	
DRC	
LPCM OUT	LPCM 48K
	LPCM 96K
MAIN PAGE	

• LPCM Output

Sets the LPCM output sample rate.

• Preferences Setup

SETUP – PREFERENCES – AUDIO

PREFERENCES PAGE	
AUDIO	
SUBTITLE	ENGLISH
DISC MENU	FRENCH
LOCALE	SPANISH
PARENTAL	CHINESE
PASSWORD	JAPANESE
SMART NAV	GERMAN
DEFAULTS	ITALIAN
MAIN PAGE	

• Audio Language Setup

Select the preferred AUDIO soundtrack by using the cursor buttons.

Preferences Setup

SETUP – PREFERENCES – SUBTITLE

PREFERENCES PAGE	
AUDIO	ENGLISH
SUBTITLE	FRENCH
DISC MENU	SPANISH
LOCALE	CHINESE
PARENTAL	JAPANESE
PASSWORD	GERMAN
SMART NAV	ITALIAN
DEFAULTS	OFF
MAIN PAGE	

- **Subtitle Language Setup**

Select the preferred SUBTITLE language by using the cursor buttons.

SETUP – PREFERENCES – DISC MENU

PREFERENCES PAGE	
AUDIO	ENGLISH
SUBTITLE	FRENCH
DISC MENU	SPANISH
LOCALE	CHINESE
PARENTAL	JAPANESE
PASSWORD	GERMAN
SMART NAV	ITALIAN
DEFAULTS	
MAIN PAGE	

- **Disc Menu Language Setup**

Select the preferred DISC MENU language by using the cursor buttons.

SETUP – PREFERENCES – LOCALE

PREFERENCES PAGE	
AUDIO	
SUBTITLE	
DISC MENU	CHINA
LOCALE	FRANCE
PARENTAL	HONG KONG
PASSWORD	JAPAN
SMART NAV	TAIWAN
DEFAULTS	GBR
MAIN PAGE	USA

- **Locale**

Select the preferred city by using the cursor buttons. The player will depend on this setting to choose a related film grade.

SETUP – PREFERENCES – PARENTAL

PREFERENCES PAGE	
AUDIO	1 G
SUBTITLE	2
DISC MENU	3 PG
LOCALE	4 PG 13
PARENTAL	5
PASSWORD	6 PG-R
SMART NAV	7 NC-17
DEFAULTS	8 ADULT
MAIN PAGE	NO PARENTAL

- **Parental**

Select suitable parental guidance by using the cursor buttons and confirm by pressing the **ENTER** button.

Preferences Setup

SETUP – PREFERENCES – PASSWORD

PREFERENCES PAGE	
AUDIO	
SUBTITLE	
DISC MENU	
LOCALE	
PARENTAL	
PASSWORD	CHANGE
SMART NAV	
DEFAULTS	
MAIN PAGE	

- **Password**

Select CHANGE and press the **ENTER** button. Type the old password (the initial factory code is 3308) and key in the 4-digit password you want to use, and retype again to confirm the new password.

SETUP – PREFERENCES – SMART NAV

PREFERENCES PAGE	
AUDIO	
SUBTITLE	
DISC MENU	
LOCALE	
PARENTAL	
PASSWORD	
SMART NAV	NO MENU
DEFAULTS	WITH MENU
MAIN PAGE	

- **Smart NAV**

Sets the playing style of MP3 discs.

SETUP – PREFERENCES – DEFAULTS

PREFERENCES PAGE	
AUDIO	
SUBTITLE	
DISC MENU	
LOCALE	
PARENTAL	
PASSWORD	
SMART NAV	
DEFAULTS	RESET
MAIN PAGE	

- **Factory Settings (Reset)**

Select RESET to return the unit to the factory settings.

The factory settings are as following:

GENERAL SETUP	TV DISPLAY	WIDE
	TV TYPE	PAL
	PIC MODE	AUTO
	ANGLE MARK	ON
	OSD LANGUAGE	ENGLISH
SPEAKER SETUP	CAPTIONS	OFF
	DOWNMIX	STEREO
AUDIO SETUP	SPDIF	OFF
	OP MODE	LINE MODE
	DUAL MONO	STEREO
	DRC	FULL
	LPCM OUT	LPCM 96K
PREFERENCES	AUDIO	ENGLISH
	SUBTITLE	ENGLISH
	DISC MENU	ENGLISH
	LOCALE	GBR
	PARENTAL	6 PG-R
	PASSWORD	3308
SMART NAV	WITH MENU	

Specifications

Supply voltage:	12 V DC (11 V - 16 V), nominal voltage 12 V, negative ground
Current consumption:	Less than 2.0 A
Signal system:	Composite video 1.0 Vp-p 75 (RCA pin jack)
Playable discs:	(1) DVD-VIDEO disc 5" (12 cm) single-sided, single-layer 5" (12 cm) single-sided, double-layer 3" (8 cm) single-sided, single-layer 3" (8 cm) single-sided, double-layer (2) Compact disc (CD-DA, VIDEO-CD, CD-R) 5" (12 cm) disc 3" (8 cm) disc
Audio output level:	10 K Ω (2 ch 1.8 Vrms)
Audio signal output characteristics:	(1) Frequency response: 20 Hz - 20 kHz (2) S/N ratio: 90 dB (JIS) (3) Wow and Flutter: Below measurable limits

Note:

The technical data and the design of the equipment are liable to be changed for the sake of technical improvements without prior notice.

• Supplied Accessories

- VS738 Digital Media Player
- DCP case
- IR remote control
- (2) AAA alkaline batteries
- Trim bezel (escutcheon)
- DIN mounting frame and release levers
- (4) M4×6 truss head machine screws
- (4) M5×5 truss head machine screws
- (4) M5×5 flat head machine screws
- (4) M5×18 hex washer head tapping screws
- (2) M5 hex nuts
- (1) Plain washer
- (1) Spring washer
- 5 meter 4-pin power supply harness
- 5 meter RCA audio cable
- 5 meter RCA video cable
- Additional IR receiver (5 meter cable)
- Installation brackets
- Backstrap
- Owner's manual/Installation guide

Clarion Co., Ltd.
Tokyo, Japan

Free Manuals Download Website

<http://myh66.com>

<http://usermanuals.us>

<http://www.somanuals.com>

<http://www.4manuals.cc>

<http://www.manual-lib.com>

<http://www.404manual.com>

<http://www.luxmanual.com>

<http://aubethermostatmanual.com>

Golf course search by state

<http://golfingnear.com>

Email search by domain

<http://emailbydomain.com>

Auto manuals search

<http://auto.somanuals.com>

TV manuals search

<http://tv.somanuals.com>