

Clarion **APA2150G** 75W × 2 channel power amplifier

OPERATION AND INSTALLATION MANUAL

1. INTRODUCTION

Powerful power supply circuit built in

The thorough-going circuit configuration uses low-loss power MOS FETs in the high-efficiency PWM DC-DC converter, high-capacity low-impedance capacitors, the large toroidal choke coil, and the copper foil dual-side printed circuit board, so the powerful built-in power supply circuit provides stable power with margin to handle even instantaneous signal changes. The transistor is a low magnetic flux leakage high-capacity EI core type transistor. Furthermore, the ripple elimination primary side choke coil directly linked to the battery and the DC-DC converter secondary side choke coil are fastened to a pedestal with auxiliary pins to improve the ability to withstand vibration.

Wealth of functions with superior operability

There is a gain control with a wide range of input sensitivity and a stereo/monaural select switch. High-pass/low-pass filter circuits with continually varying cutoff frequencies are built in. Also, since all these operations are centralized on the top surface of the heat sink, operation after installation is easy. Furthermore, since a bass boost function to emphasize the bass region is built in, this device can also be used as a bass amplification amplifier.

Power guard circuit

The amp has a built-in power guard function to hold down the gain during overdrive and prevent unpleasant clipping distortion.

Built-in protective circuits

These circuits prevent damage to the amp or speakers due to any abnormality such as excess power supply voltage, speaker terminal shorts, or high temperature.

Design emphasizing sound quality

Extremely high-reliability parts have been used for even the smallest parts, including high through rate low noise op-amps, output-stage transistors with superior current linearity, and sealed relays for switching signals to bypass complex signal lines when filters are off. This avoids all compromise and thoroughly pursues simple and straight signal lines to make possible stable speaker driving across a broad band with more faithful expression of the sound source. Also, each terminal group is equipped with gold-plated input/output terminals that transmit signals reliably and provide high reliability.

Newly designed heat sink

The main heat sink is a new design with a sleek structure. To avoid heat dispersion fins on the surface, a tunnel-shaped heat sink is placed at the center of the printed circuit board and powerfully cooled with an electric fan. Furthermore, the heat dispersion efficiency has been greatly improved by making the air flow pathway straight. Also, the audio section and power supply section are shielded to eliminate interference between blocks.

2. DESCRIPTION

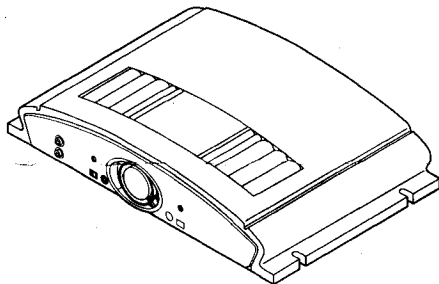

Figure 1

The Clarion APA2150G car audio amplifier (shown in Figure 1) is a 2-channel amplifier that delivers 75 watt (RMS), into 2 channels or 200 watt into 1 channel. Depending on your application, this amplifiers is an excellent choice for customizing your own car audio system.

All connections and controls are on end panels and are straightforward and easy to understand.

We use gold-plated RCA and barrier connectors to ensure the best electrical connection for your system. Included are external automotive-type fuses that are easy to replace.

3. Amplifier Controls and Power Indicator Connections

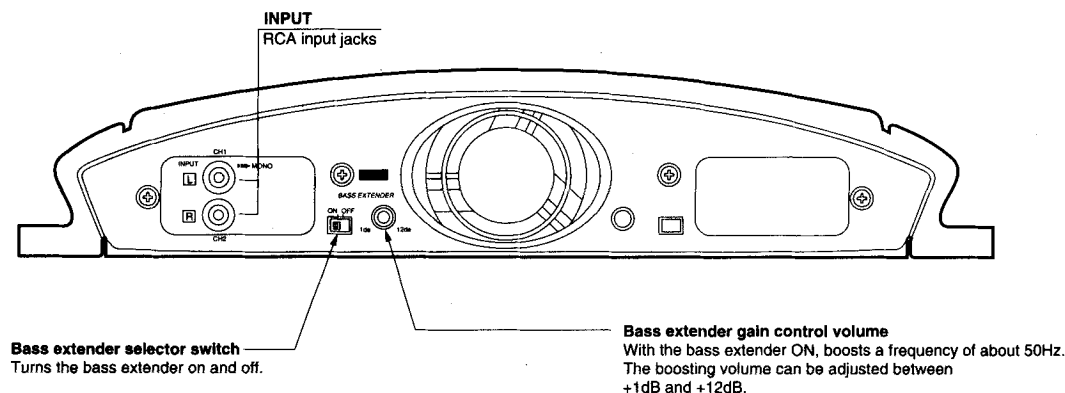
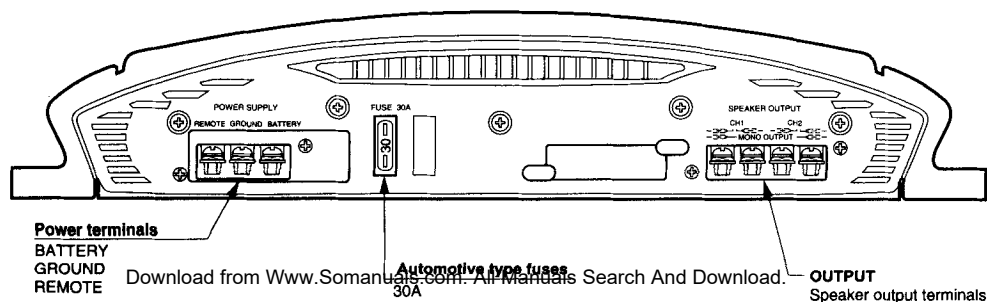

Figure 2 Front Panel Layout



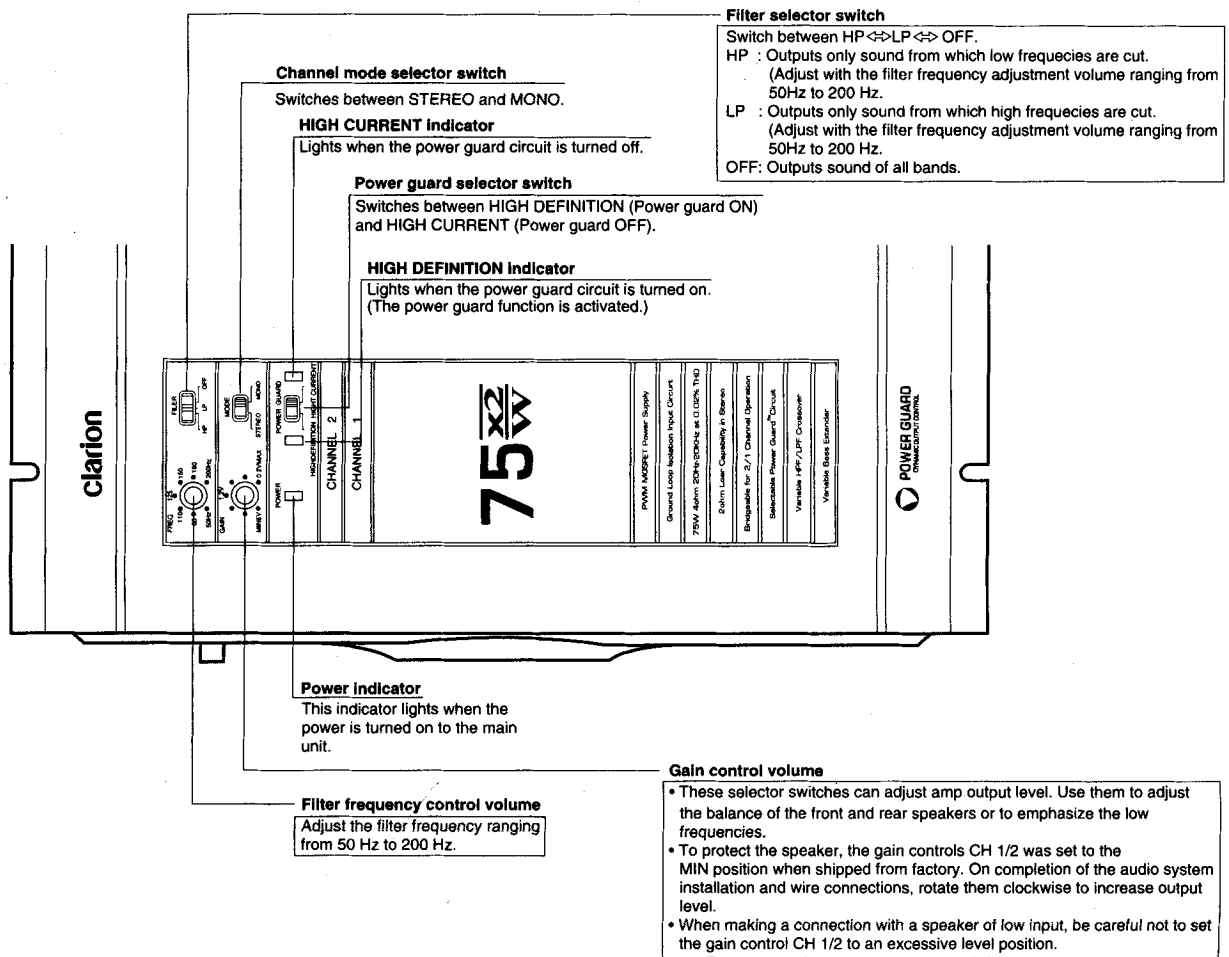
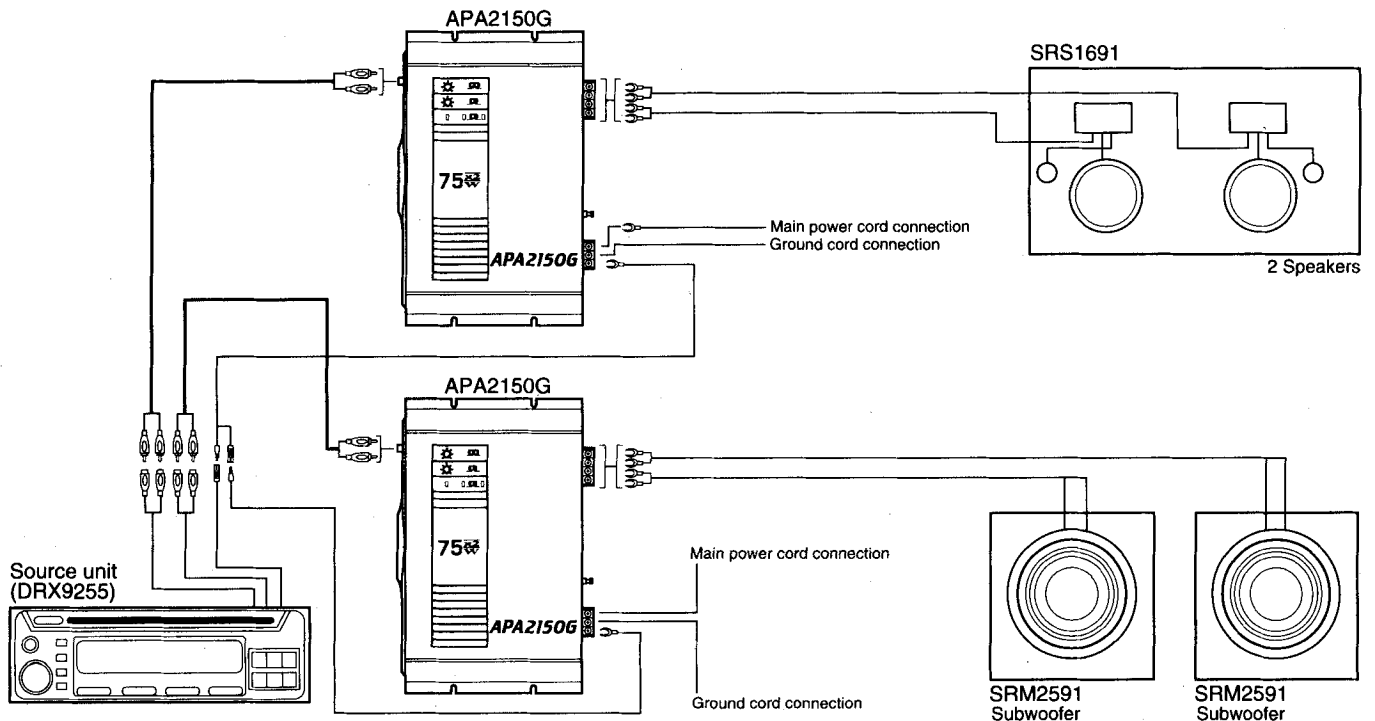

Figure 4 Upper Panel Layout

4. CONNECTIONS

1. The RCA input jacks are on the front panel, and on the rear panel are the power terminals, auto motive type fuses and speaker output terminals.
2. On the APA2150G, the gold-plated power terminals are labeled (left to right) as REMOTE (remote turn-on), GROUND and BATTERY.
3. The speaker terminals are also gold-plated.
4. The INPUT and OUTPUT connectors on the APA2150G are gold-plated RCA jacks, marked [L] for the Left channel and [R] for the Right channel.

5. APPLICATIONS



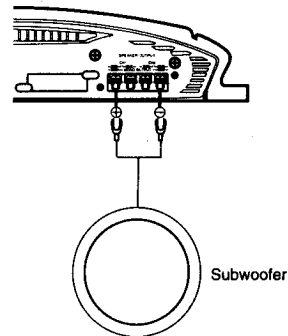
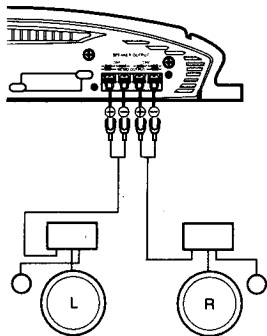
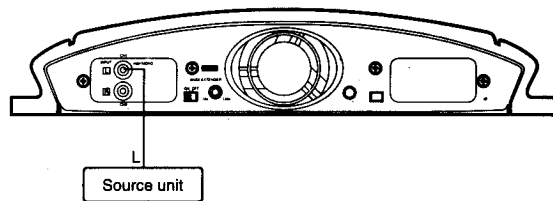
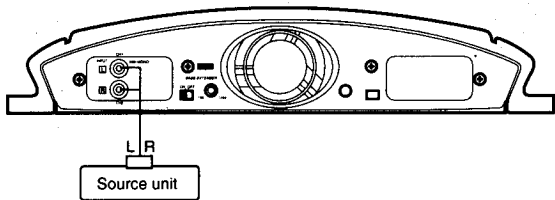

- Set the filter selector switch and the channel mode selector switch.
- Note: When setting these selectors switches, be sure to turn off the power of the source unit.

- Set the filter selector switch and the channel mode selector switch.
- Note: When setting these selectors switches, be sure to turn off the power of the source unit.

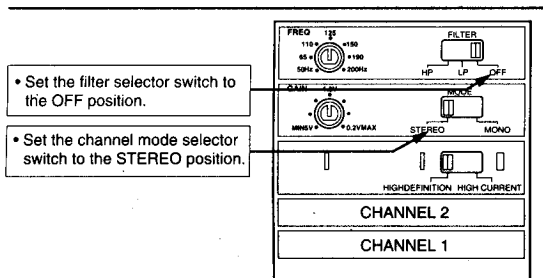

- Set the filter selector switch to the OFF position.
- Set the channel mode selector switch to the STEREO position.

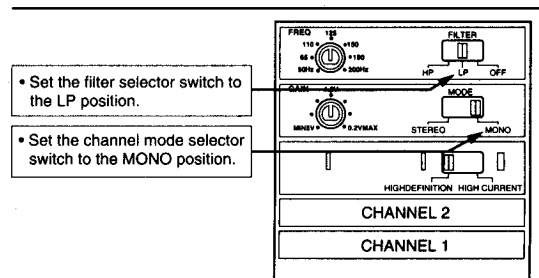

- Set the filter selector switch to the LP position.
- Set the channel mode selector switch to the MONO position.

Figure 6 Stereo mode

Figure 7 Mono mode (when using subwoofer)

6. INSTALLATION

The section lists mounting and wiring precautions for installing the Clarion APA2150G car audio amplifier. Combined with the experience of a professional installer, these safeguards are sufficiently detailed to successfully complete installation. If you do not have the necessary skills, do not install the amplifier yourself. Instead, see your authorized Clarion dealer for installation recommendations.

Mounting Precautions

Although this Clarion amplifier incorporates a large heat sink and protection circuits, mounting any amplifier in a confined space without any air movement can still damage internal circuits over time. Choose a site that provides adequate ventilation around the amplifier. For easy system set-up, mount the amplifier so the controls and fuse will be accessible after installation.

In addition, observe these precautions:

- For the most efficient cooling, mount the amplifier so cool air runs along the length of the fins rather than across them. Remember, any moving air will dissipate heat.
- Mount the amplifier on a rigid surface. Do not install the amplifier on plastic or other combustible material.
- Prior to drilling, make sure proposed mounting holes will not cut into the fuel tank, fuel lines, brake lines (under chassis), or electrical wiring.

Cautions on installation

1. Be sure to use the screws supplied with this amplifier to install it in your car. Mounting the machine using screws other than those supplied may lead to malfunctioning of the unit.
2. When you mount the machine, be careful not to damage the wiring in your car with tools or parts such as tapping screws.

Installation procedure

1. Open four holes ($\varnothing 3.5$ mm) to mount the unit.
2. Use the four tapping screws (5×30) to secure the unit.
3. When mounting the unit on a plastic plate or carpet, use the plate nuts.

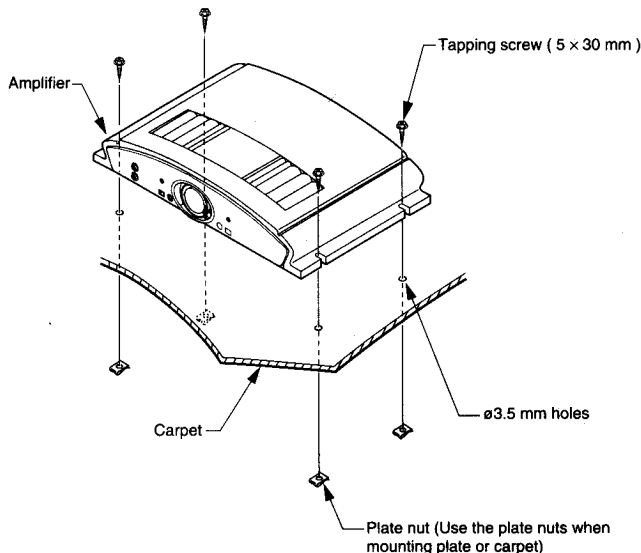

Figure 8 Installation Procedure

Wiring Precautions

- Read all wiring precautions. If you are not sure of the connections, contact your authorized Clarion dealer.
- Before installation, make sure the head unit power switch is turned OFF.
- Disconnect the negative (-) lead at the battery before making any power connections.
- When making connections, be sure that each connection is clean and secure. Insulate final connections with electrical tape or shrink tubing. Failure to do so may damage your equipment.
- A secure, clean ground connection is critical to the performance of your Clarion car audio amplifier. Use the shortest ground wire possible to minimize resistance and avoid noise problems.
- Add an external fuse on the positive (+) power lead and connect it as close as possible to the vehicle's (+) battery terminal. Use a rating that equals the total current consumption at full output of all amplifiers in the system. Adding an external fuse will protect the electrical system from short-circuits that can cause fire.
- Refer to Figure 9 when making electrical connections. Connect the amplifier's positive (+) power lead via a fuse directly to the positive (+) terminal on the car battery. Do not connect this wire to the car's fuse panel. Use yellow-insulated 10-gauge (or larger) wire for the amplifier's positive (+) power lead and the same gauge black insulated wire for the ground.
- A ring terminal cannot be used for the speaker output terminal and the power source terminal. (The terminal screw has been designed not to come off.)
- When replacing the amplifier's fuse, always use one having the same current rating. Substituting with a higher-rated fuse can reduce protection and may result in serious damage to the amplifier.
- Never ground the speakers to the vehicle chassis or body.
- Make sure that your vehicle's electrical system (i.e., alternator, battery, etc.) is capable of handling the additional load. If you are planning to install a multi-amplifier system, you may need to add a second battery and possibly upgrade the alternator with a higher-output-rated model. Consult your Clarion dealer for recommendations.
- To avoid possible noise problems, run the amplifier's positive (+) power lead along one side of the vehicle to the battery. Run the remote turn-on wire and RCA audio cable down the center, and route the speaker wires along the remaining side. If wires must cross, run the perpendicular to each other.
- When creating passage holes for the power wire, use grommets to eliminate any sharp edges created during drilling. This will protect the wire from being nicked and causing a short-circuit.
- Extra cable cause signal loss and act as an "antenna" for noise. Use only high quality RCA cables that are no longer than necessary to make a direct connection with the source unit or equalizer.
- Depending on the type of system being installed, refer to the examples in Figures 5 through 7 for information on wiring and setting the operation mode.

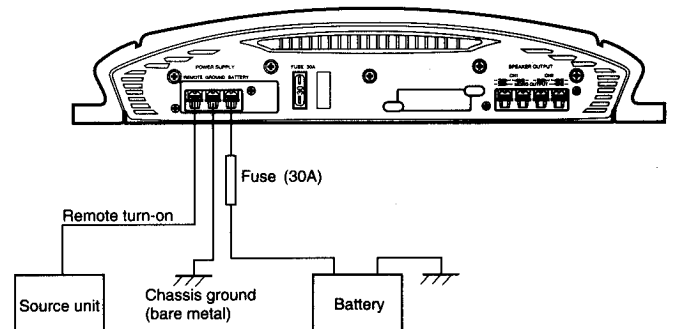

Figure 9 Electrical Connections

7. FINAL SYSTEM CHECKS

1. Start the engine and turn on the source unit. After a short two-second delay, slowly raise the volume and listen to the sound. If you hear any noise, static, distortion, or no sound at all, check the connections, and also refer to the "Troubleshooting" section. Depending on your system design, the levels may become quite loud even a low volume control settings. Until you get a "feel" of the power of the system, use care when adjusting the controls.
2. Adjust the balance control from left to right and listen to the results. Audio imaging should match control settings.
3. Increase the volume and verify that the APA2150G amplifier reproduces audio without distortion at all frequencies. If you hear distortion, check the connections and verify that the gain controls are set correctly. Another possibility is damaged (or under-powered) speakers. Once again, refer to the "Troubleshooting" section for additional help.

8. TROUBLESHOOTING

Symptom	Cause	Solution
No audio	Low or no remote turn-on voltage Blown fuse Power wires not connected Speakers not connected or blown	Check remote connections at amplifier and source unit. Replace with new fast-blow fuse (same rating). Check power and ground connections at amplifier; check battery connections. Check speaker connectors at amplifier; measure coil impedance.
Audio cycles on and off	Thermal protection circuits are shutting amplifier off.	Check location for adequate ventilation; consult an authorized Clarion dealer.
Distorted sound	Gain control is not set properly, or damaged speaker cones	Adjust gain control; check each speaker cone for signs of damage (e.g., frozen cone, burning smell, etc.).
Whining or ticking noise in the sound with engine on	Amplifier is picking up alternator noise or radiated noise	Check power and ground connections on amplifier; check or move audio cables; install an in-line noise filter on source unit's power wire; check alternator and/or voltage regulator; test for weak battery or add water to battery.

9. SPECIFICATIONS

Maximum Output:	150W × 2 (2-channel mode)
Rated Output Power:	75W × 2 (2-channel mode) (20Hz ~ 20kHz, 0.02%, 4Ω, with 2-channel simultaneous output) 100W × 2 (20Hz ~ 20kHz, 0.02%, 2Ω) 200W × 1 (1-channel mode)
Frequency Response:	10 ~ 50,000Hz
Harmonic Distortion:	0.02% (20Hz ~ 20kHz, 2-channel mode, 75W × 2 simultaneous output)
S/N Ratio:	117dB
Applicable Speaker Impedance:	4Ω (2Ω ~ 8Ω, channel mode: Stereo)
Input Sensitivity:	200mV ~ 5,000mV
Low-Pass Filter/High-Pass	
Filter Cut-off Frequency:	50Hz ~ 200Hz (-24dB/oct)
Bass Extender:	+1dB ~ +12dB (at 50 Hz)
Power Source Voltage:	14.4V
Ground:	Negative
Power Consumption:	22A (with 75W × 2 rated output) 1.0A (amplifier ON, no input) 30A × 1
Auto-fuse capacity :	
External dimensions:	14-1/2"(367mm) Width × 2-3/4"(70mm) Height × 8-5/8"(220mm) Depth
Weight:	3.9 kg (137oz)

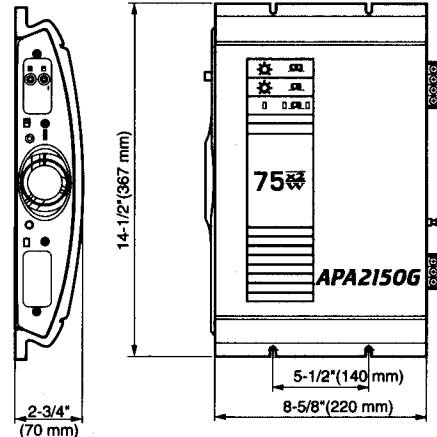

Free Manuals Download Website

<http://myh66.com>

<http://usermanuals.us>

<http://www.somanuals.com>

<http://www.4manuals.cc>

<http://www.manual-lib.com>

<http://www.404manual.com>

<http://www.luxmanual.com>

<http://aubethermostatmanual.com>

Golf course search by state

<http://golfingnear.com>

Email search by domain

<http://emailbydomain.com>

Auto manuals search

<http://auto.somanuals.com>

TV manuals search

<http://tv.somanuals.com>