

clarion

Owner's manual

使用说明书

사용 설명서

DXZ946MP

AM/FM CD/MP3/WMA PLAYER
BUILT-IN DSP/EQ WITH TOUCHPANEL

AM/FM CD/MP3/WMA播放器
内置DSP/EQ, 带触控面板

AM/FM CD/MP3/WMA 플레이어
터치패널방식 DSP/EQ 내장

carNET

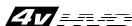
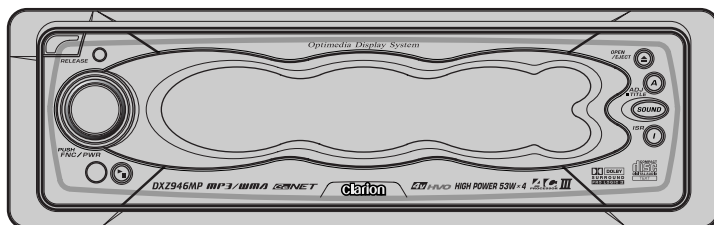

Thank you for purchasing this **Clarion** product.

- * Please read this owner's manual in its entirety before operating this unit.
- * After reading this manual, be sure to keep it in a handy place (e.g., glove compartment).
- * This manual includes the operating procedures of the CD changer and TV tuner connected via the CeNET cable. The CD changer and TV tuner have their own manuals, but no explanations for operating them are described.

Contents

1. FEATURES	2
2. PRECAUTIONS	3
Sloping Console	4
Handling Compact Discs	4
3. CONTROLS	5
4. NOMENCLATURE	6
Names of the Buttons and their Functions	6
Major Button Operations when External Equipment is Connected to this Unit	7
Display Items	8
Display Operations	8
5. DCP	9
6. REMOTE CONTROL	10
Inserting the Batteries	10
Functions of Remote Control Unit Buttons	11
7. OPERATIONS	12
Basic Operations	12
AC-Processor III Operations	17
Radio Operations	23
CD / MP3 / WMA Operations	26
Different Pieces of Music Heard by Plural Listeners (2-ZONE function)	31
Operations Common to Each Mode	32
8. OPERATIONS OF ACCESSORIES	45
CD Changer Operations	45
TV Operations	48
5.1ch Surround Decoder Operations	51
9. IN CASE OF DIFFICULTY	56
10. ERROR DISPLAYS	58
11. SPECIFICATIONS	59

1. FEATURES

- Optiimedia Display:
 - 16-Gradation 320 x 64 Full-dot LCD with Touch Panel Control
- AC PROCESSOR III:
 - Time Alignment™/VIRTUAL SPACE ENHANCER™/Dolby Pro Logic II™/3 BAND P.EQ
- ADF (Anti Distortion Filter)
- Codematic
- 24-Bit Digital to Analog Converter for Audiophile
- 4V / 6ch Gold Plated RCA Output and 2ch RCA AUX Input with 3 Level Adjustments
- 5.1ch Surround Decoder Control

2. PRECAUTIONS

1. When the inside of the car is very cold and the player is used soon after switching on the heater, moisture may form on the disc or the optical parts of the player and proper playback may not be possible. If moisture forms on the disc, wipe it off with a soft cloth. If moisture forms on the optical parts of the player, do not use the player for about 1 hour. The condensation will disappear naturally allowing normal operation.
2. Driving on extremely bumpy roads may cause severe vibration and cause the sound to skip.
3. This unit uses a precision mechanism. Even in the event that trouble arises, never open the case, disassemble the unit, or lubricate the rotating parts.

WARNING

For your safety, do not watch or operate the touch panel while driving.

CAUTION

USE OF CONTROLS, ADJUSTMENTS, OR PERFORMANCE OF PROCEDURES OTHER THAN THOSE SPECIFIED HEREIN, MAY RESULT IN HAZARDOUS RADIATION EXPOSURE.

THE COMPACT DISC PLAYER AND MINI DISC PLAYER SHOULD NOT BE ADJUSTED OR REPAIRED BY ANYONE EXCEPT PROPERLY QUALIFIED SERVICE PERSONNEL.

CHANGES OR MODIFICATIONS NOT EXPRESSLY APPROVED BY THE MANUFACTURER FOR COMPLIANCE COULD VOID THE USER'S AUTHORITY TO OPERATE THE EQUIPMENT.

INFORMATION FOR USERS:

CHANGES OR MODIFICATIONS TO THIS PRODUCT NOT APPROVED BY THE MANUFACTURER WILL VOID THE WARRANTY.

Sloping Console

This unit uses a SLOPING CONSOLE to make large screen displays possible.

When you use the SLOPING CONSOLE, be sure to close it.

⚠ CAUTION



BE CAREFUL NOT TO GET YOUR FINGERS CAUGHT WHEN OPENING AND CLOSING THE SLOPING CONSOLE.

1. For safety's sake, always close the SLOPING CONSOLE before leaving this unit unused for a prolonged period or switching OFF the ignition key.

If you switch OFF the ignition key with the SLOPING CONSOLE tilted, the SLOPING CONSOLE does not close.

2. Before the SLOPING CONSOLE closes, there may be a braking sound from the safety mechanism. This is normal.
3. If you move the SLOPING CONSOLE by hand, this may start play. To correct this play, with the power for the unit ON, press the [▲] button to close the SLOPING CONSOLE.
4. After a disc is ejected, the SLOPING CONSOLE automatically returns to the tilted or closed state. If there is any obstruction when the SLOPING CONSOLE tries to close, the safety mechanism is triggered and the SLOPING CONSOLE returns to the open state. If this happens, remove the obstruction, then press the [▲] button.
5. To avoid scratching the compact disc, keep the 12 or 8 cm CD level when loading or removing it.

Handling Compact Discs

Use only compact discs bearing the  or  mark.

Do not play heart-shaped, octagonal, or other specially shaped compact discs.

Some CDs recorded in the CD-R/CD-RW mode may not be usable.

Handling

- Compared to ordinary music CDs, CD-R and CD-RW discs are both easily affected by high temperature and humidity and some CD-R and CD-RW discs may not be playable. Therefore, do not leave them for a long time in the car.
- New discs may have some roughness around the edges. If such discs are used, the player may not work or the sound may skip. Use a ball-point pen or the like to remove any roughness from the edge of the disc.
- Never stick labels on the surface of the compact disc or mark the surface with a pencil or pen.
- Never play a compact disc with any cellophane tape or other glue on it or with peeling off marks. If you try to play such a compact disc, you may not be able to remove it from the CD player or it may damage the CD player.

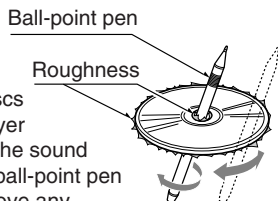

- Do not use compact discs that have large scratches, are misshapen, cracked, etc. Use of such discs may cause misoperation or damage.
- To remove a compact disc from its storage case, press down on the center of the case and lift the disc out, holding it carefully by the edges.
- Do not use commercially available CD protection sheets or discs equipped with stabilizers, etc. These may damage the disc or break the internal mechanism.

Storage

- Do not expose compact discs to direct sunlight or any heat source.
- Do not expose compact discs to excess humidity or dust.
- Do not expose compact discs to direct heat from heaters.

Cleaning

- To remove fingermarks and dust, use a soft cloth and wipe in a straight line from the center of the compact disc to the circumference.
- Do not use any solvents, such as commercially available cleaners, anti-static spray, or thinner to clean compact discs.
- After using special compact disc cleaner, let the compact disc dry off well before playing it.

3. CONTROLS

Source unit

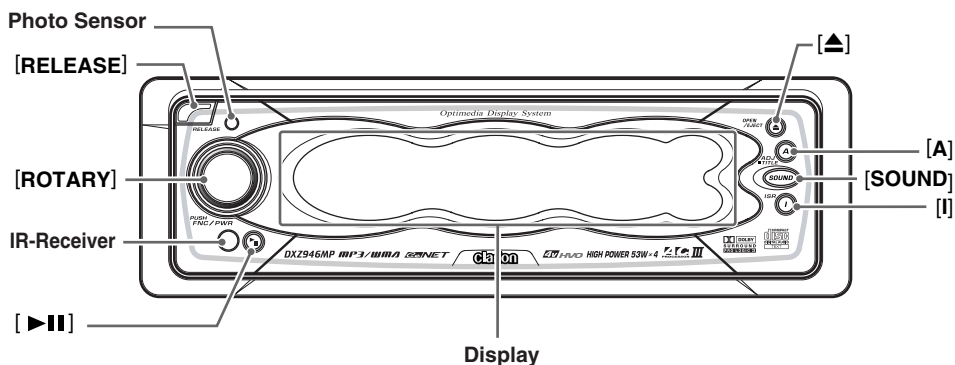

With the SLOPING CONSOLE opened

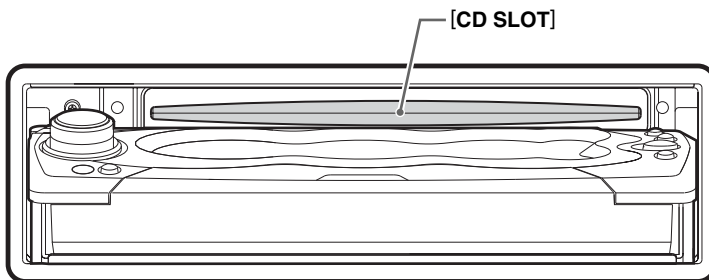

4. NOMENCLATURE

Names of the Buttons and their Functions

[RELEASE] button

- Remove the DCP.

Photo Sensor

- This sensor detects the brightness inside your car. When the auto-dimmer function is set to "AUTO", the brightness of the display is dimmed according to the brightness detected by this sensor.

[ROTARY] knob

- Press the knob to turn the power ON. Each press of this knob switches the mode.
- Press and hold the knob for 1 second or longer to turn the power OFF.
- This knob can also be turned to adjust the volume, or to adjust the various settings in the adjust mode.

[▲] button

- Opens/closes the control panel.
If a disc is already loaded, it will be ejected when the control panel is opened.

Note:

If the disc is not ejected, hold down the [▲] button for 1 second or longer.

[A] button

- Use this button to set or adjust the various settings in the adjust mode.
- Use this button to enter station names in the radio mode or disc titles in the CD mode.

[SOUND] button

- Use this button for setting or adjusting various settings such as audio space.
- Holding this button down for 1 second or longer also toggles the 2-ZONE function ON and OFF.

[I] button

- Immediately calls up a favorite radio station regardless of the current mode. (This is the ISR function.) You can store radio stations to the [I] button by holding this button down for 2 seconds or longer in the radio mode (when the 2-ZONE function is "OFF").
Switches the operation of the 2-ZONE function. Holding this button down for 1 second or longer switches the 2-ZONE type (when the 2-ZONE function is "ON").

[▶||] button

- Pauses and unpauses a track (in the CD mode).

Display

- Displays the various information that indicates the operating state of this unit such as tuning/play state and indicators.
- Touch the display with your finger, and touch  to enable operation. (cf. page 8)

Major Button Operations when External Equipment is Connected to this Unit

● When the CD/DVD changer is connected

- * For details, see the section “**CD changer operations**” (cf. page 45). For the DVD changer, refer to the Owner’s Manual provided with the DVD changer.

[▶||] button

- Play or pause a CD or DVD.

[A] button

- Used for entering disc titles in the CD changer mode.

● When the TV is connected

- * For details, see the section “**TV operations**” (cf. page 48).

[▶||] button

- Switch the TV picture mode or VTR (external) picture mode.

[A] button

- Used for entering the name of the TV station.

Display Items

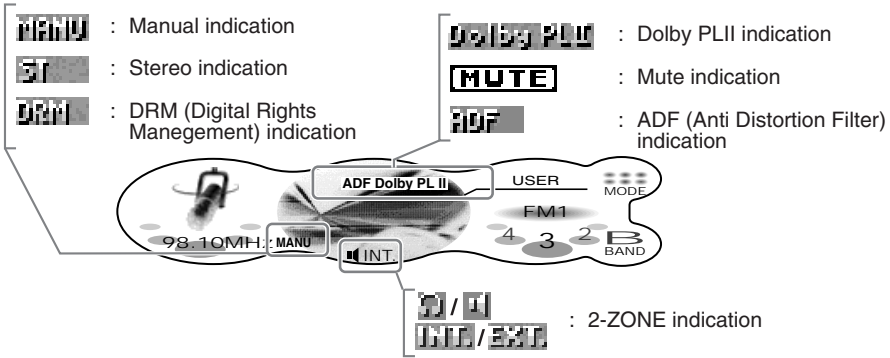

Display Operations

A touch panel display is used as the display on this unit. You can operate this display just by touching it with your fingertip. There are four main display operations as follows:

Touch

Touch the display with your fingertip and take it away within 1 second. This is the most basic operation when operating the display.

Touch

Touch the display with your fingertip, and move your finger to the left (←) or right (→) with your fingertip still touching the display, and take your fingertip away within 1 second. This operation is used for selecting preset memory (1 to 6) or tracks.

Touch and hold

Touch the display with your fingertip and hold it on the display for 1 or 2 seconds or longer. Do not move your finger while you are touching the display.

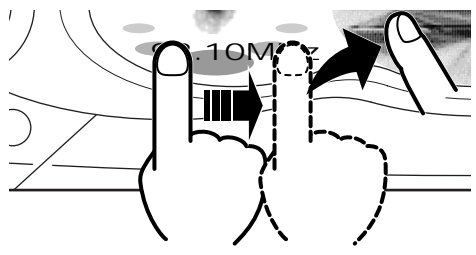

Touching and holding the display for 1 second or longer displays lists, for example, and calls up other handy functions.

Touching and holding the display for 2 seconds or longer is used for storing preset memory or other information.

Touch

Touch the display with your fingertip, and move your finger to the left (←) or right (→) with your fingertip still touching the display, and keep your fingertip on the display. The current operation continues for the time your fingertip is held on the display. This operation is used, for example, for manual tuning or fast-forwarding/fast-backwarding tracks.

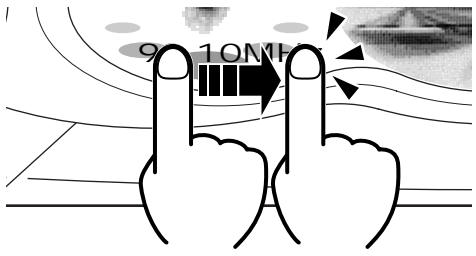

5. DCP

The control panel can be detached to prevent theft. When detaching the control panel, store it in the DCP (DETACHABLE CONTROL PANEL) case to prevent scratches.

We recommend taking the DCP with you when leaving the car.

Removing the DCP

1. With the SLOPING CONSOLE closed, turn off the power.
2. Press the [RELEASE] button deeply to open the DCP.

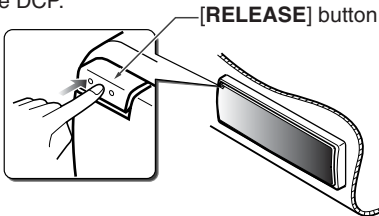

3. Pull the DCP toward you and remove it.

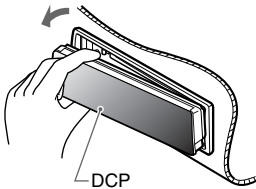

⚠ CAUTION

- Always close the SLOPING CONSOLE before removing the DCP.
- If you remove the DCP with the SLOPING CONSOLE open, the sloping console closes immediately. Be careful not to get your fingers caught.

Attaching the DCP

1. Insert the DCP so that the (A) section on the right side of the DCP catches on the hook (B) on the unit.

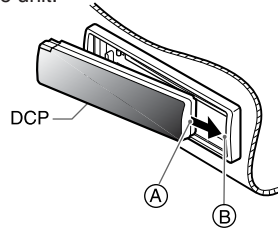

2. Press the left side (C) of the DCP carefully to fit it in place.

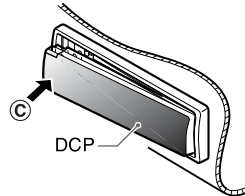

⚠ CAUTION

- The DCP can easily be damaged by shocks. After removing it, be careful not to drop it or subject it to strong shocks.
- If the [RELEASE] button is pressed and the DCP is not locked into place, it may fall out from vibration of the car. This can break the DCP, so after removing it, either install it on the unit or put it in its DCP case.
- The connector connecting the unit and the DCP is an extremely important part. Be careful not to damage it by pressing on it with fingernails, screwdrivers, etc.

Note:

- If the DCP is dirty, wipe off the dirt with a soft, dry cloth only.

6. REMOTE CONTROL

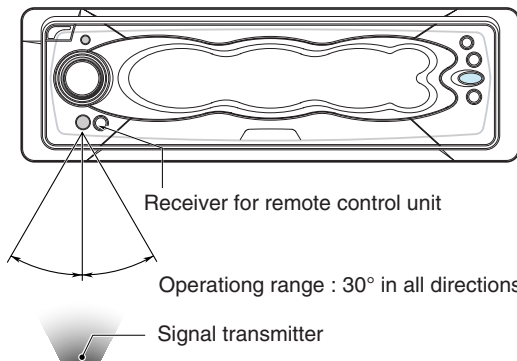

Remote control unit

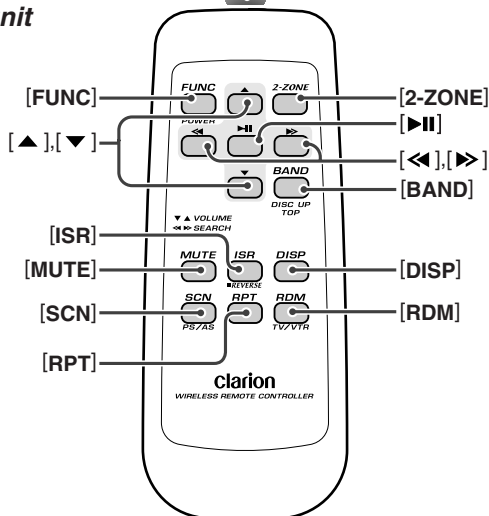

Inserting the Batteries

1. Turn the remote control unit over, then slide the rear cover in the direction of the arrow.
2. Insert the AA (SUM-3, R-6/1.5V) batteries that came with the remote control unit facing in the directions shown in the figure, then close the rear cover.

Notes:

Using batteries improperly can cause them to explode. Take note of the following points:

- When replacing batteries, replace both batteries with new ones.
- Do not short-circuit, disassemble or heat batteries.
- Do not dispose of batteries into fire or flames.
- Dispose of spent batteries properly.

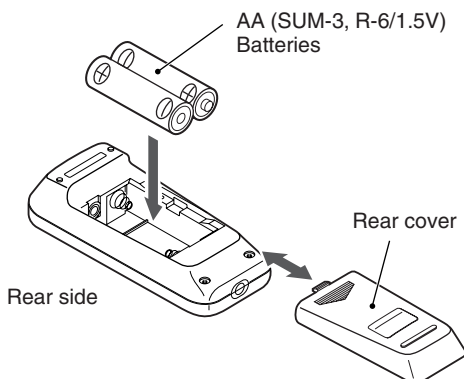

Functions of Remote Control Unit Buttons

Mode Button	Radio	CD/MP3	CD changer/ DVD changer	TV
[FUNC]	Switches among radio, CD/MP3, CD changer, DVD changer, TV and AUX.			
[BAND]	Switches reception band.	Plays the first track. Top play.	Moves the next disc in increasing order.	Switches reception band.
[▲], [▼]	Increases and decreases volume (in all modes).			
[◀], [▶]	Moves preset channels up and down.	Moves tracks up and down. When pressed and held for 1 second or longer: Fast-forward/fast-backward.		Moves preset channels up and down.
[▶▶]	No function.	Switches between playback and pause.		No function.
[MUTE]	Turns mute on and off.			
[ISR]	Recalls ISR radio station in memory. Press and hold for 2 seconds or longer: Stores current station into ISR memory (radio mode only). Press and hold the button for 1 second or longer to switch the main and sub zone sound source.(only while 2-ZONE mode on)			
[DISP]	Switches among main display, clock display.			
[SCN]	Preset scan. When pressed and held for 2 seconds or longer: Auto store.	Scan play. Press and hold the button for 1 second or longer to perform folder scan play while in the MP3/WMA disc.	Scan play. When pressed and held for 1 second or longer: Disc scan play.	Preset scan. When pressed and held for 2 seconds or longer: Auto store.
[RPT]	No function.	Repeat play. Press and hold the button for 1 second or longer to perform folder Repeat play while in the MP3/WMA disc.	Repeat play. When pressed and held for 1 second or longer: Disc repeat play.	No function.
[RDM]	No function.	Random play. Press and hold the button for 1 second or longer to perform folder Random play while in the MP3/WMA disc.	Random play. When pressed and held for 1 second or longer: Disc random play.	Switches between TV and VTR.
[2-ZONE]	Press and hold for 1 second or longer to turn on or off the 2-ZONE mode. Press to switch the control zone between main zone or sub zone while 2-ZONE mode on.			

* Some of the corresponding buttons on the main unit and remote control unit have different functions.

7. OPERATIONS

Basic Operations

⚠ CAUTION

Be sure to lower the volume before switching the unit off or the ignition key. The unit remembers its last volume setting. If you switch the power OFF with the volume up, when you switch the power back ON, the sudden loud volume may hurt your hearing and damage the unit.

Turning ON/OFF the power

Turning on

Note:

• Be careful when using this unit for a long time without running the engine. If you drain the car's battery too far, you may not be able to start the engine and this can reduce the service life of the battery.

1. Press the [ROTARY] knob.
The mode that was previously active is displayed.

System check

The first time that this unit is turned on after wire connections are completed, this unit checks which equipment is connected. (This is called the "system check.") When the power is turned ON, and "System Check" is displayed, follow the procedure below to perform the system check.

1. When "System Check" appears on the display, press the [ROTARY] knob.
The system check starts.
When the system check is complete, "Completed" appears on the display.
2. Press the [ROTARY] knob again.
The main display for the radio mode appears.

CODEMATIC function

When "CODEMATIC" is set to "ON", and the power is turned ON with the DCP attached, the Touch Code display appears. Touch the display in the order that was set in the adjust mode.



For details on the CODEMATIC function, see "Using the security function" (cf. page 44).

Turning off

1. Hold down the [ROTARY] knob for 1 second or longer.
* If the power is turned OFF with the clock displayed, the clock will stay displayed even after the power is turned OFF.

Selecting a mode

1. Press the [ROTARY] knob to change the operation mode.
2. Each time you press the [ROTARY] knob, the operation mode changes in the following order:
Radio mode → CD/MP3 mode → CD changer mode → DVD changer mode → TV mode → AUX mode → Radio mode...
* External equipment not connected with CeNET is not displayed.

Adjusting the volume

1. Turning the [ROTARY] knob clockwise increases the volume; turning it counterclockwise decreases the volume.
* The volume level is from 0 (minimum) to 33 (maximum).

Switching the operation mode

There are 2 basic operation modes: standard operation and simple operation.

1. In the main display screen, touch and hold the left of the display for 1 second or longer. The operation mode is switched.

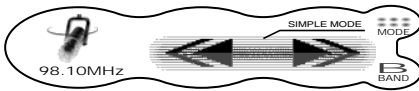

In the simple operation, the operations of touching or in the radio mode or CD mode main display screen are not required, and this unit can be used by performing simple operation.

Note, however, that the following operations are not available in the simple operation.

- Preset tuning, folder selection, disc selection, and other operations that involve touching on the right of the display
- Display switching operations (cf. page 13)
- Title display switching operations (cf. page 14)
- Operations for displaying title entry screens. In screens (e.g. list display, adjust mode, etc.) other than the main display, there is no difference between the standard operation and the simple operation.

Descriptions given in this manual are mainly for the standard operation. For descriptions for operations in the simple operation, refer to the descriptions for the screen displays in the radio mode or the CD mode.

Switching the display

1. Touch the center of the display. Each time you touch the display, it changes as follows:

Title display

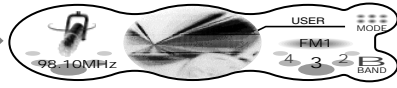

Spectrum Analyzer display

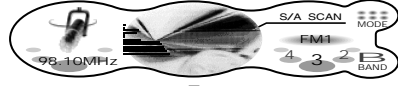

Time display

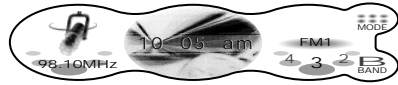

Screen saver

When the screen saver function is set to "ON", and you do not operate this unit for about 30 seconds, the screen saver will be displayed. For details, see page 36.

Wallpaper

Touching and holding the center of the display for 1 second or longer switches to the wallpaper display.

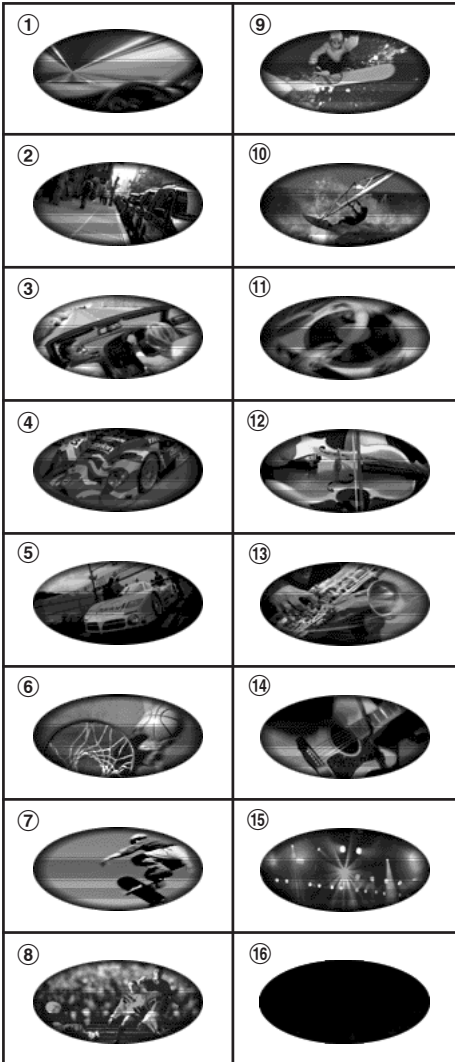

Spectrum analyzer display

Touching and holding the right of the display for 1 second or longer during the spectrum analyzer (S/A) display switches the spectrum analyzer display.

S/A SCAN	S/A 1, S/A 2, and S/A 3 are displayed for 10 seconds or longer each.
S/A 1	
S/A 2	
S/A 3	

Switching the title display

You can display disc titles and other information that is stored to discs when playing back CDs in the CD or CD changer modes.

1. Touch and hold the right of the display for 1 second or longer in the title display. Each time you touch and hold the display switches the display as follows:

CD-TEXT disc

User title (disc) → CD-text title (disc) → Artist name → CD-text title (track) → User title (disc)...

MP3/WMA disc

Folder → File → Album TAG → Artist TAG → Title TAG → Folder...

Notes:

- MP3 supports ID3 Tags V2.3 / 2.2 / 1.1 / 1.0.
- Tag displays give priority to V2.3 / 2.2.
- In the case of album Tags for WMA, the information written into the extension header is displayed.
- Only ASCII characters can be displayed in Tags.

■ To scroll a title

Touch on the title display while the title is displayed.

The title scrolls to the left.

■ To stop scrolling

Touch  on the title display.

Setting the ADF

- ADF is the abbreviation of Anti Distortion Filter.

The adopted “**Liveliness Enhancement Filter**” and “**Sound Tone Compensation**” functions allow well-modulated realistic playback without affecting the characteristics of the original sound tone.

This unit are provided with 4 types of sound tone effects stored in memory. Select the one you prefer.

ADF-1 : Suitable for genuine speakers

ADF-2 : Suitable for separate speakers

ADF-3 : Suitable for co-axial speakers

USER : This setting can be adjusted by the user to his or her individual preference.

OFF : No sound effect

- The factory default setting for “**OFF**”.

Notes:

- As the volume changes when ADF is switched, switch ADF with the volume and “**SW VOLUME**” (sub-woofer) and “**CTR VOLUME**” (center speaker) turned down as far as possible.
- On some speaker systems, sufficient effect sometimes cannot be obtained. If this happens, adjust the ADF parameter or the volume.
- When ADF is set to “**USER**”, “**1**”, “**2**” or “**3**”, the VSE function and BASS/TREB function under EQ-SELECT are disabled.

1. Press the **[SOUND]** button.
2. Touch ADF.



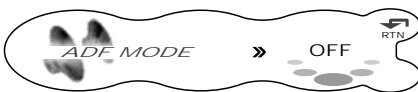

3. Touch  on the right of the display to select the ADF mode.



When ADF is set to “**OFF**”, the ADF setting is not reflected on the music source. This ends the ADF setting. Press the **[SOUND]** button to return to the original mode.

- * Select one of USER, 1, 2, 3, or OFF.

4. To change the details of the ADF setting, press the **[A]** button.
5. Touch  on the adjustment item display to select the desired item. Each touch of  switches the adjustment item display as follows:

- **Adjustment item (when USER is selected in step 3)**

BASS → TREBLE → COMP → BASS...

- **Adjustment item (when 1 to 3 is selected in step 3)**

LEVEL → COMP → LEVEL...

6. Touch  on the right of the display to adjust the item.
 - * “**BASS**” and “**TREBLE**” can be adjusted within the range 1 to 13.
 - * “**LEVEL**” can be adjusted within the range -3 to +3.
 - * Select either “**ON**” or “**OFF**” for “**COMP**”.
7. Press the **[SOUND]** button to return to the original mode.

Adjusting the Sub-woofer and Center Speaker

- “**SW VOLUME**” (sub-woofer) can be adjusted only when “**SUB-WOOFER**” is set to “**ON**”.
- “**CTR VOLUME**” (center speaker) can be adjusted only when the Dolby Pro Logic II mode is set to either “**MUSIC**” or “**MATRIX**”, “**SP-SETTING**” is set to “**CTR+SW**” and “**CENTER-SP**” is set to “**ON**”.
- The factory default setting for SW VOLUME is “**0**” and for CTR VOLUME is “**0**”.

1. Press the **[SOUND]** button.
2. Touch A-MODE.



3. Touch  on the adjustment item display to select “**SW VOLUME**” or “**CTR VOLUME**”.



Basic Operations

- Touch on the right of the display and adjust the item as desired.
* This item can be adjusted within the range -5 to +5.
- Press the **[SOUND]** button to return to the original mode.

Adjusting balance/fader

BALANCE:

Adjusts the volume balance between the left and right speakers.

FADER:

Adjust the volume balance between the front and rear speakers.

- The factory default setting for BALANCE is "0" and for FADER is "0".

Note:

- Balance/fader cannot be adjusted when "PRO" is selected at AC-PRO III (cf. page 39) and the position function is set to "ON". Adjust balance/fader by the "Selecting the position menu" (cf. page 17).

- Press the **[SOUND]** button.
- Touch A-MODE.



- Touch on the adjustment item display to select "BALANCE" or "FADER".



- Touch on the right of the display adjust the item as desired.
* "BALANCE" can be adjusted within the range L13 (left side emphasized) and R13 (right side emphasized).
* "FADER" can be adjusted within the range R12 (rear side emphasized) and F12 (front side emphasized).
- Press the **[SOUND]** button to return to the original mode.

Adjusting bass/treble

The bass/treble mode can be adjusted only when the Dolby Pro Logic II mode is set to "OFF" (cf. page 17) and "EQ SELECT" is set to "BAS/TREB" (cf. page 39).

- The factory default setting is "0".

- Press the **[SOUND]** button.
- Touch A-MODE.



- Touch on the adjustment item display to select "BASS" or "TREBLE".



- Touch on the right of the display and adjust the item as desired.
* This item can be adjusted within the range -6 to +6.
- Repeat steps 3 and 4 to adjust the desired item.
- Press the **[SOUND]** button to return to the original mode.

Dolby Pro Logic II

Dolby Pro Logic II is a matrix decoding technology in which updated digital matrix technology is applied and Dolby Pro Logic is further improved. Dolby Pro Logic II realizes excellent 5.1 channel reproduction of Dolby surround source as well as stereo sound sources such as CDs, thereby causing a surround channel to be full-ranged (20 Hz to 20 kHz) and become stereo. Therefore, you can enjoy any stereo sources with dynamic sound of 5.1 channel. The Music Mode or Matrix Mode can be selected according to a source to be reproduced.

This product is manufactured under license from Dolby Laboratories. "Dolby", "Pro Logic" and the double-D symbol are trademarks of Dolby Laboratories.

Selecting the PL II menu (Dolby PL II)

Select the MUSIC mode or the MATRIX mode matched the source you are to play as the Dolby Pro Logic II mode.

- The factory default setting is "OFF".

■ MUSIC (music mode)

- This mode is suited for stereo sound sources such as CDs.
- Another adjustment mode that enables more detailed adjustment is also available as the sound field spreads differently depending on the state of the recorded music source. (See page 42)

■ MATRIX (matrix mode)

- This mode is suited for sound sources such as AM/FM radio.

■ OFF

- The Dolby Pro Logic II mode is not used, and the AC-PROIII mode is used. For details on the AC-PROIII mode, see "Selecting each mode" (cf. page 39).

- Press the [SOUND] button.
- Touch Dolby PLII.



- Touch on the right of the display to select the Dolby Pro Logic II mode.

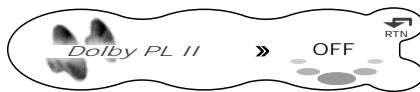

The mode display is switched as follows:

MUSIC (music mode) → MATRIX (matrix mode) → OFF (PL II off) → MUSIC (music mode)...

* For details on the volume adjustment of the center speaker/sub-woofer, see page 40.

- Touch RTN.

Selecting the position menu

With POSITION, you can select from 5 types it takes for the sound to arrive from the speaker to your seat position.

Also, the time alignment function allows pin-point setting of speakers so that the same audio effect can be obtained from each speaker up to all listeners.

In the "Selecting each mode" procedure (cf. page 39), set AC-PROIII to "PRO".

- The factory default setting for POSITION is "OFF" and for the position basic menu is "FRONT".

■ Position menu

This function is pre-stored with 5 position menus. Select the desired menu to suit your preference.

- Press the [SOUND] button.
- Touch POSITION.



- Touch on the ON/OFF display. The position effect is toggled ON/OFF.



When the position effect is set to “OFF”, the position setting is not reflected on the music source. This ends the position setting. Press the [SOUND] button to return to the original mode.

- Touch B/U to select “BASIC”.



Each touch of B/U toggles between “BASIC” and “USER”.

- Touch on the position basic menu No. to select the position basic menu.

Position basic menu

No.	Display Name	Seat Position
1	FRONT-L	Front left seat
2	FRONT-R	Front right seat
3	FRONT	Front seats
4	REAR	Rear seats
5	FULL SEAT	All seats

- Press the [SOUND] button to return to the original mode.

Adjusting/storing positions (user memory)

With user memory, pin-point setting of speakers is enabled so that the same audio effect can be obtained from each speaker up to all listeners based upon the position basic menu. Up to 5 adjustment setups can be stored to user memory.

T-ALIGN (time alignment):

The distance from the listener up to each speaker can be entered in 2.3 cm steps, and the time that the sound reaches the listener from each speaker can be adjusted.

SP GAIN (speaker gain):

Adjusts the speaker output level. Adjust so that the volumes that are output from each speaker are all the same.

- Press the [SOUND] button.
- Touch POSITION.
- Touch on the ON/OFF display. The position effect is toggled ON/OFF.
- Touch B/U to select “BASIC” or “USER”.
- Touch on the right of the display to select the menu that is used as the menu for adjustment.
- Press the [A] button.
- Touch on the left of the display to select “T-ALIGN” or “SP GAIN”.
- Touch on the center of the display to select each adjustment item. Each touch of switches the adjustment items as follows:

Adjustment items

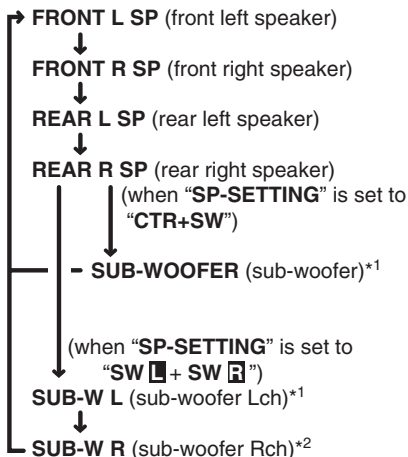

*1 This is displayed only when “SUB-WOOFER” under “SOUND” in the adjust mode is set to “ON”.

*2 This is displayed only when “SUB-WOOFER” under “SOUND” in the adjust mode is set to “ON”, and “T-ALIGN” is selected at step 7.

- Touch on the right of the display and adjust the item as desired.



* “T-ALIGN” can be adjusted within the range 0 cm to 501.4 cm in 2.3 cm steps.
 * “SP GAIN” can be adjusted within the range -20dB to 0dB.

10. Repeat steps 7 to 9 to adjust the desired item.
11. When you have finished adjusting each item, touch RTN.
The display returns to the original screen, and "»" is displayed at the BASIC or USER display.
Operation so far completes position adjustment. To continue to store the adjustment values to the position user menu, perform the following.
12. Touch and hold RTN for 1 second or longer.
The position menu list is displayed.
13. Touch and hold the user memory you want to store the adjustment values to for 2 seconds or longer.
You will hear a long beep, and the values you adjusted up to step 10 are stored to the position user menu.
If you hear a short beep, the adjustment values up to step 10 are discarded. Adjust these values again as required.
14. Touch RTN.
15. Press the [SOUND] button to return to the original mode.
* To select a stored user memory, touch B/U to display "USER" and touch of on the user memory No.

Selecting the VSE menu

VSE (Virtual Space Enhancer) allows you to compensate the sound pressure balance inside your car so that the same sound effect can be obtained whichever seat you are sitting in as proved in compensation simulations. In the "Selecting each mode" procedure (cf. page 39), set AC-PROIII to "STD".

- The factory default setting for VSE is "OFF" and for the VSE basic menu is "FLAT".

■ VSE basic menu

Six basic menus are pre-stored to this function. Select the basic menu to suit your preference.

1. Press the [SOUND] button.
2. Touch VSE.



3. Touch on the ON/OFF display.
The VSE effect is toggled ON/OFF.



When VSE is set to "OFF", the VSE setting is not reflected on the music source. This completes the VSE setting. Press the [SOUND] button to return to the original mode.

4. Touch B/U to select "BASIC".



Each touch of B/U toggles between "BASIC" and "USER".

5. Touch on the VSE basic menu No. to select the desired VSE basic menu.

VSE basic menus

No.	Function Name	Description
1	FLAT	Sound source flat equalizing
2	BASS BOOST	Bass tones enhanced
3	HIGH BOOST	Mid and treble enhanced
4	IMPACT	Low and treble enhanced
5	ACOUSTICAL	Mid tones (human voice) enhanced
6	SMOOTH	Produces smooth-sounding tones.

6. Press the [SOUND] button to return to the original mode.

Adjusting/storing VSE (user memory)

User memory settings allow you to compensate the sound pressure distribution to suit your preference based upon the VSE basic menu. Up to six user adjustments can be stored.

DIFFUSE:

Adjusts the deviation in diffused sound pressure.

CAR WIDTH:

Adjusts the deviation in sound pressure along the width of the car.

CAR LENGTH:

Adjusts the deviation in sound pressure along the length of the car.

1. Press the [SOUND] button.
2. Touch VSE.
3. Touch on the ON/OFF display. The VSE effect is toggled ON/OFF.
4. Touch B/U to select "BASIC" or "USER".
5. Touch on the right of the display to select the menu that is used as the menu for adjustment.
6. Press the [A] button.
7. Touch on the adjustment item display to select "DIFFUSE", "CAR WIDTH" or "CAR LENGTH".



8. Touch on the right of the display and adjust the item as desired.
* This item can be adjusted within the range 1 to 10.
9. Repeat steps 7 and 8 to adjust the desired item.
10. When you have finished adjusting each item, touch RTN.
The display returns to the original screen, and ">>" is displayed at the BASIC or USER display.
Operation so far completes VSE adjustment. To continue to store the adjustment values to the VSE user menu, perform the following.
11. Touch and hold RTN for 1 second or longer. The VSE user menu list is displayed.
12. Touch and hold the user memory you want to store the adjustment values to for 2 seconds or longer.
You will hear a long beep, and the values you adjusted up to step 9 are stored to the VSE user menu.
If you hear a short beep, the adjustment values up to step 9 are discarded. Adjust these values again as required.
13. Touch RTN.
14. Press the [SOUND] button to return to the original mode.
* To select a stored user memory, touch B/U to display "USER" and touch on the user memory No.

Selecting the P.EQ menu

P.EQ (Parametric Equalizer) allows you to compensate the entire frequency level range in detail by smooth curve using frequency compensation matched to the type of your car. In the "Selecting each mode" procedure (cf. page 39), set EQ SELECT to "P.EQ".

- The factory default setting for P.EQ is "OFF" and for the P.EQ basic menu is "SEDAN-1".

■ P.EQ basic menu

6 types of P.EQ basic menu are pre-stored to this function matched to the type of your car and the speaker mounting position. Select the basic menu to suit your car.

1. Press the [SOUND] button.
2. Touch P.EQ.



3. Touch on the ON/OFF display. The P.EQ effect is toggled ON/OFF.



When the P.EQ effect is set to "OFF", the P.EQ setting is not reflected on the music source. This ends the P.EQ setting. Press the [SOUND] button to return to the original mode.

4. Touch B/U to select "BASIC".



Each touch of B/U toggles between "BASIC" and "USER".

5. Touch on the P.EQ basic menu No. to select the P.EQ basic menu.



P.EQ basic menu

No.	Display name	Speaker Mounting position
1	SEDAN-1	Front: Front door Rear: Rear parcel
2	SEDAN-2	Front: Front door Rear: Rear door
3	WAGON-1	Front: Front door Rear: Luggage (side)
4	WAGON-2	Front: Front door Rear: Rear door
5	MINI VAN-1	Front: Front door Rear: Luggage (side)
6	MINI VAN-2	Front: Front door Rear: Rear door



- Press the [SOUND] button to return to the original mode.

Adjusting/storing P.EQ (user memory)

With user memory, you can compensate the frequency characteristics to suit your car based upon the P.EQ basic menu. Up to 6 adjustment setups can be stored to user memory. For details, see "P.EQ adjustment".



- Press the [SOUND] button.
- Touch P.EQ.
- Touch  on the ON/OFF display. The P.EQ effect is toggled ON/OFF.
- Touch B/U to select "BASIC" or "USER".
- Touch  on the right of the display to select the menu that is used as the menu for adjustment.
- Press the [A] button.
- Touch  on the left of the display to select "FRONT" or "REAR".



- Touch  on the center of the display to select each adjustment item. Each touch of  switches the adjustment item as follows:

Adjustment items

BAND → FREQ → Q → GAIN → BAND...

- Touch  on the right of the display and adjust the item as desired.
 - * "BAND" can be adjusted within the range 1 to 3.
 - * "FREQ" can be adjusted within the range 20Hz to 20kHz.
 - * Select one of 1, 3, 5, 7, or 20 as "Q".
 - * "GAIN" can be adjusted within the range -12dB to +12dB.
- Repeat steps 7 to 9 to adjust the desired item.
- When you have finished adjusting each item, touch RTN. The display returns to the original screen, and "»" is displayed at the BASIC or USER display. Operation so far completes P.EQ adjustment. To continue to store the adjustment values to the P.EQ user menu, perform the following.
 - Touch and hold RTN for 1 second or longer. The P.EQ menu list is displayed.
 - Touch and hold the user memory you want to store the adjustment values to for 2 seconds or longer. You will hear a long beep, and the values you adjusted up to step 10 are stored to the P.EQ menu. If you hear a short beep, the adjustment values up to step 10 are discarded. Adjust these values again as required.
- Touch RTN.
- Press the [SOUND] button to return to the original mode.
 - * To select a stored user memory, touch B/U to display "USER" and touch  on the user memory No.

■ P.EQ adjustment

The settings that can be adjusted in the P.EQ menu are as follows. The center frequency, gain and Q curve can be stored to channel/band combinations.

For example, center frequency "250Hz", gain "-8dB" and Q curve "3" can be stored to band 1 on the front.

FRONT/REAR (channel selection)

Selects the channel (front or rear) to adjust.

BAND (band selection)

Selects the frequency band (1 to 3) to adjust. Set the center frequency (FREQUENCY), gain (GAIN) and Q curve (Q) for each frequency band.

FREQUENCY (center frequency selection)

Selects the frequency to be used as the center of the frequency band to be compensated from the range 20Hz to 20kHz.

(1/3 octave steps, 31 points)

GAIN (gain adjustment)

Adjusts the gain (output level) within the range -12dB to +12dB.

(1dB steps, 25 points)

Q (Q curve selection)

Sets one of 1, 3, 5, 7, or 20 as the sharpness of the Q curve.

● Compensation

There is no need to compensate frequency characteristics if they are flat (no peaks or valleys) when you have measured the frequency characteristics with a measuring device. However, sometimes the frequency characteristics rise or fall in some places. If this happens, the frequency characteristics must be compensated. Create a frequency curve having characteristics that are opposite to the center frequency of parts where the characteristics rise and fall to cancel out these peaks and valleys, and make the frequency characteristics as flat as possible.

Making the frequency characteristics as flat as possible is called **"compensation."**

On this unit, frequency characteristics can be compensated by P.EQ (Parametric Equalizer).

● Compensation of frequency characteristics

The figure below shows the relationship between the center frequency, gain and Q curve.

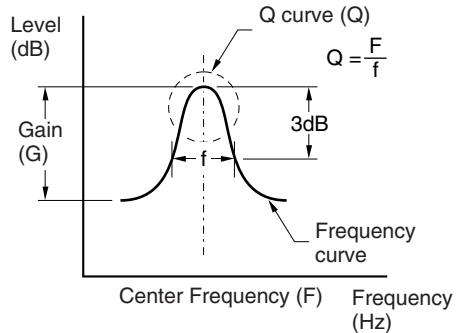

● Q curve

The Q curve becomes sharper when the numerical value is increased, and smoother when the numerical value is decreased.

Flat frequency characteristics can be made by selecting a Q curve opposite to that of the curve to be compensated.

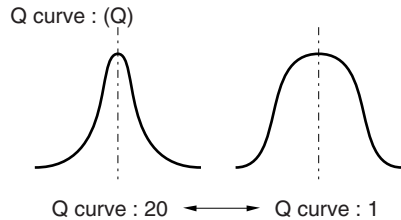

F: Center frequency, G: Gain (output level), Q: Q curve

No. (car type)	Parametric Equalizer Parameters									
	Channel	Band 1			Band 2			Band 3		
		F	G	Q	F	G	Q	F	G	Q
1 (SEDAN-1)	Front	250 Hz	-8 dB	3	2 kHz	-4 dB	1	5 kHz	-4 dB	1
	Rear	250 Hz	-10 dB	3	1.25 kHz	0 dB	5	8 kHz	0 dB	5
2 (SEDAN-2)	Front	250 Hz	-10 dB	7	800 Hz	-4 dB	3	8 kHz	-5 dB	1
	Rear	80 Hz	3 dB	7	125 Hz	-12 dB	5	1.25 kHz	0 dB	5
3 (WAGON-1)	Front	250 Hz	-8 dB	3	1 kHz	-8 dB	3	10 kHz	-6 dB	1
	Rear	250 Hz	-8 dB	3	800 Hz	-8 dB	1	8 kHz	0 dB	5
4 (WAGON-2)	Front	250 Hz	-8 dB	7	400 Hz	-10 dB	7	1.25 kHz	-8 dB	7
	Rear	125 Hz	-8 dB	3	500 Hz	-5 dB	5	1.6 kHz	0 dB	3
5 (MINI VAN-1)	Front	125 Hz	-4 dB	5	1.25 kHz	-4 dB	3	2 kHz	3 dB	7
	Rear	250 Hz	-6 dB	1	630 Hz	-4 dB	3	8 kHz	0 dB	5
6 (MINI VAN-2)	Front	250 Hz	-4 dB	3	1.25 Hz	-8 dB	3	80 Hz	3 dB	3
	Rear	250 Hz	-8 dB	3	500 Hz	-5 dB	5	8 kHz	0 dB	5

Radio Operations

Screen displays in the radio mode

■ Main display

This is displayed by pressing the [ROTARY] knob and selecting the radio mode.

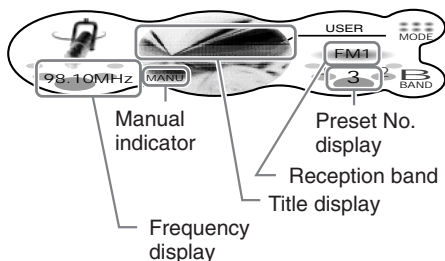

Touching the left of the display for 1 second or longer switches the simple operation display.

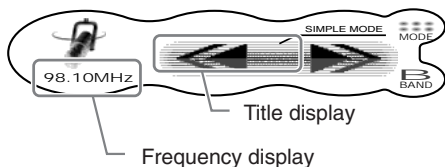

Frequency display

The frequency currently being received is displayed.

Touching ◀▶ or the ↕ in the standard operation display allows you to perform seek tuning or manual tuning.

Title display

Displays the name of the broadcast channel currently being received. Touching this name switches the display.

Reception band display

AM: AM band name

FM1: FM band name

Preset No. display

Touching ↕ in the standard operation display selects a preset memory.

MODE

Touching this displays sub-functions. Touching and holding this for 1 second or longer displays the preset memory list.

P-SCAN:

This is displayed during a preset scan. Touching this ends the preset scan.

A-STORE:

This is displayed during an auto store. Touching this ends auto store.

BAND

Touching this switches the reception band. Touching and holding this for 1 second or longer switches between the manual tuning mode and the seek tuning mode.

◀▶ (only in the simple operation display)

Touching these enables seek tuning or step tuning (in the manual tuning mode). Touching and holding these enables quick tuning (in the manual tuning mode).

■ Preset memory list display

This is displayed when MODE is touched and held for 1 second or longer in the main display.

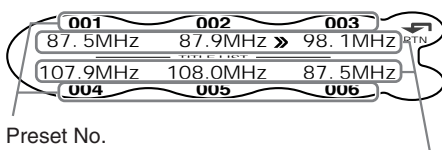

Station name (or frequency)

▶▶: Tuning in progress

RTN: Touch this to return to the main display.

Listening to the radio

1. Press the [ROTARY] knob to select the radio mode.

Each press of the [ROTARY] knob switches the mode as follows:

Radio → CD/MP3 → (CD Changer) → (DVD Changer) → (TV) → AUX → Radio...

* The mode of equipment that is not connected is not displayed.

2. Touch BAND to switch the reception band. Each touch of BAND switches the reception band as follows:

FM1 → FM2 → FM3 → AM → FM1...

Tuning

There are 3 types of tuning mode available, seek tuning, manual tuning and preset tuning.

Seek tuning

Seek tuning is a function for automatically tuning stations with good reception.

1. Touch and hold BAND for 1 second or longer while MANU is displayed.
Automatic tuning is possible when MANU disappears.
2. Touch on the frequency display. SEEK UP/SEEK DOWN is displayed, and tuning starts.
Tuning automatically stops at stations with good reception.

■ To cancel tuning

1. Touch on the frequency display again.

Manual tuning

There are 2 ways available: quick tuning and step tuning.

In the step tuning mode, the frequency changes 1 step at a time. In the quick tuning mode, you can quickly tune the desired frequency.

1. Touch and hold BAND for 1 second or longer while MANU is not displayed.
Manual tuning is possible when MANU is displayed.
2. Operate the frequency display to tune to a frequency on which there is a broadcast.

● Step tuning

Touch on the frequency display.

● Quick tuning

Touch on the frequency display. Tuning stops when you take your finger away from the panel.

Recalling a preset station

Recalling a preset station is a function for tuning pre-stored stations.

1. Touch and hold MODE for 1 second or longer.
The preset memory list is displayed.
2. Touch the station you want to listen to.
* In the normal mode, preset No. can also be tuned by touching in the main display.

■ To cancel tuning

1. Touch RTN.

Preset memory

A total of 24 preset positions (6-FM1, 6-FM2, 6-FM3, 6-AM) exists to store individual radio stations in memory.

1. Touch BAND to switch the reception band.
2. Operate the frequency display to store the station to.
3. Touch and hold MODE for 1 second or longer.
The preset memory list is displayed.
4. Touch and hold the preset No. to store the station to for 2 seconds or longer.
You will hear a long beep, and the station is stored in memory.

Auto store

Auto store is a function for storing up to 6 stations that are automatically tuned in sequentially.

1. Touch MODE.
2. Touch and hold A-STORE for 2 seconds or longer.
The MODE display changes to "A-STORE" and the preset No. in the auto-store operation appears on the preset No. display.
* Stations with good reception are automatically searched, and are stored to preset memory (No.1 to No.6) in order from the station having the lowest frequency.

Notes:

- When auto store is performed, stations stored to memory so far are cleared.
- When there are fewer than 6 stations with good reception, low frequencies are automatically returned to, and auto store is performed again. If there are fewer than 6 stations even after auto store is performed twice, stations stored so far remain in memory.

Preset scan

Preset scan is a function for receiving stations in the order that they are currently stored to preset No. so that broadcasts can be checked.

1. Touch MODE.
2. Touch P-SCAN.
The MODE display changes to “**P-SCAN**” and the preset No. in the preset scan operation is displayed in the preset No. display.
* The currently stored stations are received in order for 7 seconds or longer each. Stations with poor reception are skipped, and the next station is received.
When preset scan is performed in an FM broadcast, FM stations are received as follows:
FM1 (1 → 6) → FM2 (1 → 6) → FM3 (1 → 6) → FM1 (1 → 6)...
When preset scan is performed in an AM broadcast, AM stations are received as follows:
AM (1 → 6) → AM (1 → 6) and so forth.

■ To cancel preset scan

1. Touch P-SCAN.
The P-SCAN display changes to “**MODE**”, and the stations that were being received when P-SCAN was touched are received next.

Instant station recall (ISR)

Instant station recall is a special radio preset that instantly accesses a favorite radio station at a touch of a button. The ISR function even operates with the unit in other modes.

- The ISR function cannot be used when the 2-ZONE function is in use.
- The factory default setting is “**FM87.9MHz**”.
1. Press the [I] button.
“**ISR**” appears on the display.

■ To return to the previous mode

Either press the [I] button again, or press the [ROTARY] knob.

■ To store the station to “ISR”

In the radio mode, tune the station to store, and touch and hold the [I] button for 2 seconds or longer.

You will hear a long beep, and the station currently being received is stored to ISR.

CD / MP3 / WMA Operations

Screen displays in the CD mode

■ Main display

This is displayed by pressing the [ROTARY] knob to select the CD mode.

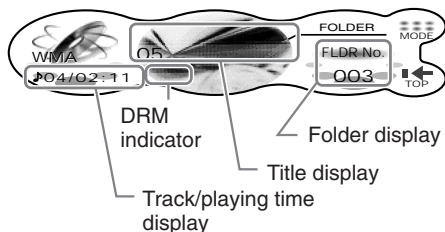

Touching the left of the display for 1 second or longer switches the simple operation display.

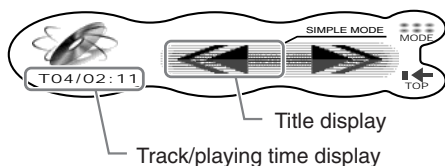

Track/playing time display

♫ 01/02: 00:

The track No. being played and the playing time are displayed.

If or is touched in the standard operation display, you can select the track to play, or fast-forward or fast-backward tracks.

Title display

The display is switched when this display is touched.

Folder display (in the case of MP3/WMA)

Touching in the standard operation display selects folders.

MODE:

Touching this displays sub-functions. Touching and holding this in the case of MP3/WMA for 1 second or longer displays the folder list.

Note:

- This function is enabled only when a disc is playing.
- ♫ -SCAN/-SCAN: This is displayed during scan play. Touching this ends scan play.
- ♫ -RPT/-RPT: This is displayed during repeat play. Touching this ends repeat play.
- ♫ -RDM/-RDM: This is displayed during random play. Touching this ends random play.

TOP:

Touching this starts play from the track at the top of the disc or folder being played.

◀▶ (only in the simple operation display)

Touching these buttons selects the track to play. Touching and holding these buttons fast-forwards or fast-backwards tracks.

■ Folder list display (in the case of MP3/WMA)

This is displayed by touching and holding MODE for 1 second or longer in the main display.

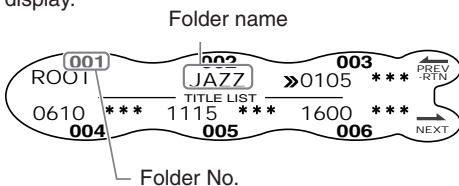

Folder No.

When this is displayed in gray, the folder cannot be selected.

▶▶: Selection in progress

Touching a folder name returns the screen to the main display, and play starts from the first track in the folder you touched.

◀ PREV-RTN:

Touching this displays the previous folder list. Touching and holding this for 1 second or longer returns the screen to the main display.

→ NEXT:

Touching this displays the next folder list.

What is MP3?

MP3 is an audio compression method and is classified as audio layer 3 of the MPEG standard.

This audio compression method has gained ground into PC users and Become a standard format.

This MP3 features original audio data compression to about 10 percent of its initial size while keeping high sound quality intact. This means that about 10 music CDs can be recorded on a CD-R disc or CD-RW disc to allow a long listening time without having to change CDs.

What is WMA?

WMA is the abbreviation of Windows Media Audio, an audio file format developed by Microsoft Corporation.

Notes:

- If you play a file with DRM (Digital Rights Management) for WMA remaining ON, no audio is output. (The WMA indicator blinks)
- Windows Media™, and the Windows® logo are trademarks, or stored trademarks of Microsoft Corporation in the United States and/or other countries.

● To disable DRM (Digital Rights Management):

- When using Windows Media Player 8, click on TOOLS → OPTIONS → COPY MUSIC tab, then under COPY SETTINGS, unclick the check box for PROTECT CONTENT. Then, reconstruct files.
- When using Windows Media Player 9, click on TOOLS → OPTIONS → MUSIC record tab, then under COPY SETTINGS, unclick the check box for PROTECT CONTENT. Then, reconstruct files.

Personally constructed WMA files are used at your own responsibility.

Precautions when creating an MP3/WMA disc

● Usable sampling rates and bit rates:

1. MP3:
Sampling rate: 11.025 kHz to 48 kHz
Bit rate: 8 kbps to 320 kbps / VBR
2. WMA:
Bit rate 48 kbps to 192 kbps

● File extensions

1. Always add a file extension “.MP3” or “.WMA” to an MP3 or WMA file by using single byte letters. If you add a file extension other than specified or forget to add the file extension, the file cannot be played.
2. Files without MP3/WMA data will not play. The indication “--: --” appears in the playing time display if you attempt to play files without MP3/WMA data.

● Logical format (File system)

1. When writing an MP3/WMA file on a CD-R disc or CD-RW disc, please select “**ISO9660 level 1, 2 or JOLIET or Romeo**” as the writing software format. Normal play may not be possible if the disc is recorded on another format.
2. The folder name and file name can be displayed as the title in the case of MP3/WMA play but the title must be within 128 single byte alphabetical letters and numerals (including an extension).
3. Do not give a name to a file inside a folder having the same name.

● Folder structure

1. A disc with a folder having more than 8 hierarchical levels is not allowed.

● Number of files or folders

1. Up to 255 files can be recognized per folder. Up to 500 files can be played.
2. Tracks are played in the order that they were recorded onto a disc. (Tracks might not always be played in the order displayed on the PC.)
3. Some noise may occur depending on the type of encoder software used while recording.

Multi-session selection

This function allows you to select either CD-DA or MP3/WMA files in the case of discs (e.g. CD-EXTRA) containing a mixture of CD-DA (music CD) and MP3/WMA files.

1. Touch MODE.
2. Touch M-SESS.
Each touch of M-SESS toggles the M-SESS display between "CD" (play CD-DA) or "MP3/WMA" (play MP3/WMA).
* If M-SESS is not displayed, touch NEXT.
3. Touch RTN.
The multi-session selection setting is reflected the next time you load a CD.

Note:

- When playing a CCCD (Copy Control CD), set the setting to CD type. When this is set to MP3/WMA type, the cannot be playing normally in some cases.

Disc-In-Play function

As long as the ignition key is turned to the ON or ACC position, the control panel opens by pressing the [▲] button even if this unit is not turned on. This function also allows you to turn the unit on and start playing the disc automatically.

⚠ CAUTION

Be careful not to catch your hand or fingers while closing the SLOPING CONSOLE.

Notes:



- If the SLOPING CONSOLE does not open fully, gently open with your hand.
- After loading a CD, always close the SLOPING CONSOLE.
- Do not try to put your hand or fingers in the CD SLOT. Also never insert foreign objects into the slot.
- Do not load discs where adhesive comes out from cellophane tape or a rental CD label, or discs with marks where cellophane tape or rental CD labels were removed. It may be impossible to eject these discs from the unit and they may cause the unit to break down.

Loading a CD

1. Press the [▲] button.
The control panel opens.

2. Load the disc into the CD SLOT.
When the disc is loaded, the control panel automatically closes after several seconds, and play starts.

Notes:

- Never insert foreign objects into the CD SLOT.
- If the CD is not loaded easily, there may be another CD in the mechanism or the unit may require service.
- Discs not bearing the  or  mark and CD-ROMs cannot be played by this unit.
- Some CDs recorded in the CD-R/CD-RW mode may not be usable.

Loading 8 cm compact discs

No adapter is required to play an 8 cm CD. Load the 8 cm CD into the center of the CD SLOT.

Ejecting a CD

You can eject a disc by pressing the [▲] button even if the engine key or ACC is at the OFF position automatically.

⚠ CAUTION

When the disc is ejected, press the [▲] button to close the control panel. If the control panel is left open, You will hear a double beep, and the control panel automatically closes.

1. Press the [▲] button.
The control panel opens, and the disc is ejected. The mode automatically switches to the radio mode.
 - * Be sure to remove ejected discs from this unit. If you leave the disc in the disc tray, it is pulled back into the unit after 15 seconds or longer, and the control panel closes. (auto reload function)
 - * Single CDs are not auto-loaded. Be sure to remove single CDs after ejecting them.

⚠ CAUTION

If you use excessive force to load a disc after it has been ejected, the surface of the disc may become scratched. Remove the disc before loading it again.

Listening to a disc already loaded in the unit

1. Press the [ROTARY] knob to select the CD mode.
 - * Play automatically starts when the mode changes to the CD mode.

Pausing play









1. Press the [▶||] button.

■ To resume play

1. Press the [▶||] button again.

Selecting a track

When a CD-R/CD-RW recorded with an MP3 file or a WMA file is loaded, you can select only tracks recorded to the same folder by touching  on the track display.

1. To listen to the next track, touch  on the track display.
2. To listen to the previous track, touch  twice on the track display. Touching  plays the next track. If you touch  more times, the track advances ahead to the track for the number of times you touched  and that track is played. Touching  plays the previous track. If you touch  more times, the track moves back to the track for the number of times you touched  and that track is played.
 - * If you touch  twice on the track display while the start of the track is being played, the track 2 tracks back is sometimes played.

■ To select a folder

To select a different folder, either touch  on the folder display, or perform the following.

1. Touch and hold MODE for 1 second or longer. The folder list is displayed. Touching PREV or NEXT displays the previous or next part of the folder list.
2. Touch the folder name.

■ To play the play list

Play lists (M3U file) also can be played. Note, however, that of M3U files currently saved down to five layers (including the root) in the file hierarchy, only the top 5 files having new file timestamps can be played.

Notes:

- Up to 255 files can be played in a single play list.
- Only MP3 or WMA files currently saved to folders down to five layers (including the root) in the file hierarchy can be played.



Perform the following to play the play list.

1. Touch MODE.
2. Touch NEXT.
3. Touch PLY LIST. Reading of the play list starts. When reading of the play list ends, the play list having the newest timestamp starts automatically. The operation of selecting the play list or tracks in the play list is the same as that of selecting a folder or tracks in a folder.
 - * PLY LIST is not displayed when a correct play list (M3U file) is not saved on the CD-R/CD-RW loaded on the unit.

■ Stopping play of play list

1. Touch MODE.
2. Touch NEXT.
3. Touch PLY LIST.

Fast-forward/Fast-backward

1. To fast-forward, touch  on the track display.
2. To fast-backward, touch  on the track display.

Top function

The top function resets the CD player to the first track of the disc.

1. Touch TOP. Play starts from the first track (track No.1). In case of MP3/WMA, the first track of a folder being played will be returned.

Scan play

This function allows you to locate and play the first 10 seconds of all the tracks recorded on a disc.

1. Touch MODE.
2. Touch \mathcal{J} -SCAN.
The MODE display changes to " \mathcal{J} -SCAN" and scan play starts.
* Scan play starts from the next track after the track currently being played.

■ To cancel scan play

1. Touch \mathcal{J} -SCAN.
The \mathcal{J} -SCAN display changes to "MODE", and the track that was playing when you touched \mathcal{J} -SCAN is played.

Folder scan play

This function allows you to locate and play the first 10 seconds of the first track of all the folders on an MP3/WMA disc.

1. Touch MODE.
2. Touch \blacksquare -SCAN.
The MODE display changes to " \blacksquare -SCAN" and folder scan play starts.
* Folder scan play starts from the folder following the folder that is playing.

■ To cancel folder scan play

1. Touch \blacksquare -SCAN.
The \blacksquare -SCAN display changes to "MODE", and the track that was playing when you touched \blacksquare -SCAN is played.

Repeat play

This function allows you to play the current track repeatedly.

1. Touch MODE.
2. Touch \mathcal{J} -REPEAT.
The MODE display changes to " \mathcal{J} -RPT" and repeat play is started.

■ To cancel repeat play

1. Touch \mathcal{J} -RPT.
The \mathcal{J} -RPT display changes to "MODE", and regular play starts from the track that was playing when you touched \mathcal{J} -RPT.

Folder repeat play

This function allows you to repeatedly play the folder currently being played. This function is available only when a CD-R/CD-RW recorded with MP3 files or WMA files is loaded.

1. Touch MODE.
2. Touch \blacksquare -REPEAT.
The MODE display changes to " \blacksquare -RPT" and folder repeat play is started.

■ To cancel folder repeat play

1. Touch \blacksquare -RPT.
The \blacksquare -RPT display changes to "MODE", and regular play starts from the track that was playing when you touched \blacksquare -RPT.

Random play

This function allows you to play all tracks recorded on a disc in a random order.

\mathcal{J} -RANDOM

Plays all tracks on the disc at random. When the disc contains 2 or more folders, all of the tracks in the folder are played at random, followed by all of the tracks in the next folder. This is repeated for all folders.

\blacksquare -RANDOM

Plays tracks on the disc at random. This function is available only when a CD-R/CD-RW recorded with MP3 files or WMA files is loaded.

1. Touch MODE.
2. Touch \mathcal{J} -RANDOM or \blacksquare -RANDOM.
The MODE display changes to " \mathcal{J} -RDM" or " \blacksquare -RDM", and random play starts.

■ To cancel random play

1. Touch \mathcal{J} -RDM or \blacksquare -RDM.
The \mathcal{J} -RDM display or \blacksquare -RDM display changes to "MODE", and regular play starts from the track that was playing when you touched these buttons.

Different Pieces of Music Heard by Plural Listeners (2-ZONE function)

The 2-ZONE function outputs separate sounds from the MAIN zone and SUB zone by simultaneously operating 2 sources in the 1 center unit, thereby allowing 2 or more listeners to enjoy separate music sources.

This unit can control its internal sources (radio, CD, MP3, etc.) to play them back, and further, can simultaneously play back sources from external equipment connected via CeNET (for instance, CD changers etc.).

The sources of the MAIN zone are played back from the speakers inside your car, and those of the SUB zone are from the headphone systems (WH104/WH204).

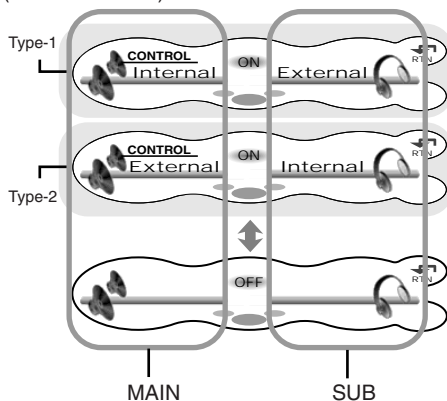

The upper figure is for when a sound source is being played by the unit's internal mode (radio, CD, AUX) on the speakers.

The lower figure is for when a sound source is being played by the unit's external mode (CD changer, DVD changer, TV, AUX) on the speakers.

- The factory default setting is "OFF".

Notes:

- The ISR function is not available while the 2-ZONE function is in use.
- The new volume adjustment made by turning the [ROTARY] knob on this unit is reflected only on the speakers.
The AUX-SENS setting is reflected on both the speakers and the headphones.

■ Screen display when the 2-ZONE function is in use

"INT." (internal mode) or "EXT." (external mode) is displayed in the center of the display to indicate whether you can hear play in the internal mode or external mode in the current 2-ZONE function operation mode.

1. Press the [SOUND] button.
2. Touch 2-ZONE.



3. Touch and hold the ON/OFF center of the display for 1 second or longer.

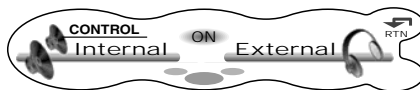

When 2-ZONE is set to ON, the current 2-ZONE type is displayed.

The 2-ZONE function is not available when 2-ZONE is set to OFF. Press the [SOUND] button to return to the original mode.

4. Touch on the ON/OFF display to select the 2-ZONE type.

2-ZONE type

	Speaker	Headphones
Type 1	Internal (internal mode)	External (external mode)
Type 2	External (external mode)	Internal (internal mode)

5. Touch the speaker display or the headphone display to select the 2-ZONE function operation mode.
If you touch the speaker display, you can operate audio on the speakers.
If you touch the headphone display, you can operate audio on the headphones.
6. Press the [SOUND] button to return to the original mode.

■ To switch the 2-ZONE function ON/OFF

1. Press and hold the [SOUND] button on the unit for 1 second or longer.

Different Pieces of Music Heard by Plural Listeners (2-ZONE function)

■ To switch the 2-ZONE type

Press and hold the [I] button on the unit for 1 second or longer while the 2-ZONE function is in use.

■ To switch the 2-ZONE function operation mode

Press the [I] button on the unit while the 2-ZONE function is in use.

Selecting the mode when the 2-ZONE function is in use

When you load a CD while the 2-ZONE function is in use, the functions of the internal mode on this unit change to CD, and play starts automatically.

1. Press the [I] button on the unit to switch the 2-ZONE function operation mode.
The display for the equipment (speaker or headphone) that can be currently operated is switched.
2. Press and hold the [I] button for 1 second or longer to select the 2-ZONE type.
The "INT." or "EXT." display is toggled.
3. Press the [ROTARY] knob.
Each press of the [ROTARY] knob while "INT." is displayed switches the mode as follows:

Radio → CD → AUX → Radio...

Each press of the [ROTARY] knob while "EXT." is displayed switches the mode as follows:

AUX → (CD changer) → (DVD changer) → (TV *) → AUX...

* The mode of equipment that is not connected is not displayed.

*1 When the TV mode is selected, the mode automatically changes to the VTR mode, and cannot be changed.

Operations Common to Each Mode

Screen display in the title entry mode

■ Main display

This is displayed when the title entry mode is selected. (cf. page 14)

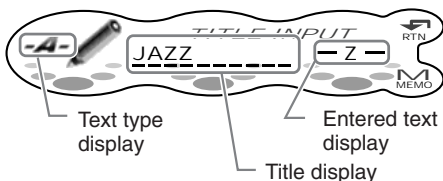

Text type display

A: Capital alphabet letters

a: Small alphabet letters

0-9: Numbers

!?: Symbols

Å: Umlaut

Title display

The currently entered title is displayed. Touch to determine the entry position. Touching and holding the button for 2 seconds or longer causes all title text to disappear.

Entered text display

Touch to select the entered text.

RTN

Touching this cancels entry of titles, and returns the display to the original screen. Touching and holding this for 1 second or longer displays the text list matched to current text type.

MEMO

Touching and holding this for 2 seconds or longer stores the title that was input, and returns the display to the original screen.

■ Text list display

This is displayed by touching and holding RTN for 1 second or longer in the main display.



Type of text

The text that is displayed changes according to the text type display.

When text type display is “A”: A E I M Q U X (space)

When text type display is “a”: a e i m q u x

When text type is “0-9”, “!” or “A”: All characters are displayed.

RTN

Touching this returns the display to the main display.

NEXT

Touching this displays the next text list.

Entering titles

You can give radio and TV stations a title up to 10 characters long, and to CDs. These titles can be displayed when broadcasts are received or when playing CDs.

The number of titles that can be entered is as follows:

Mode	Number of titles
CD mode	50 titles
TV mode	20 titles
Radio mode	30 titles

CD changer mode	Number of titles
DCZ625 connected	100 titles
CDC655Tz connected	100 titles
CDC1255z connected	50 titles

1. Either receive the radio or TV station, or play a CD for which you want to enter the title.
2. Touch the center of the display to set to the user title display.
When the display changes to the user title display, “USER” is displayed above the preset No. display.
3. Press and hold the [A] button for 1 second or longer.
The mode changes to the title entry mode.
4. Touch on the title display to determine the entry position.
The position of the blinking text moves to the left or the right.



* Up to ten characters can be input.

CAUTION

Pressing the reset button clears all user memories such as titles stored on this unit.

5. Touch on the text type display to select the type of text.
Each touch of switches the type of text as follows:

Capital alphabet letters

(space) A B C D E F G H I J K L M N O P Q R S T U V W X Y Z

Small alphabet letters

a b c d e f g h i j k l m n o p q r s t u v w x y z

Numbers

0 1 2 3 4 5 6 7 8 9

Symbols, Umlaut

À Á Ê Ë Ì Æ Ø å ä ë é è ì ö ü æ ø

6. Either touch on the right of the display, or turn the [ROTARY] knob to determine the entered characters.
7. Repeat steps 4 to 6 to enter the title.
Pressing and holding the title display for 2 seconds or longer causes all currently entered title characters to disappear.
8. Touch and hold MEMO for 2 seconds or longer.
You will hear a long beep, and the title is stored in memory.

To switch the title display to the clock or other display

Touch the center of the display.

When a new title is stored beyond the maximum number of titles

In the case of a radio or TV station

Titles not stored to preset channels and ISR (radio stations only) are automatically cleared, and the new title is stored in memory.

In the case of a CD

Titles of CDs that have been played the least are cleared, and the new title is stored in memory.

Clearing titles

1. Either receive the radio or TV station, or play a CD whose title you want to clear.
2. Touch the center of the display to set to the user title display.
When the display changes to the user title display, "USER" is displayed above the preset No. display.
3. Press and hold the [A] button for 1 second or longer.
The mode changes to the title entry mode.
4. Touch and hold the title display for 2 seconds or longer.
All characters in the title disappear.
5. Touch and hold MEMO for 2 seconds or longer.
You will hear a long beep, and the title is cleared.

Triggered audio mute for cellular telephones

This unit requires special wiring to mute the audio signal automatically when a cellular telephone rings in the car.

- * This function is not compatible with all cellular telephones. Contact your local authorized Clarion dealer for information on proper installation and compatibility.

Changing settings

Selecting setting items

1. Press the [A] button.
The mode changes to the adjust mode.



2. Touch on the setting item display to select the item to set.
 - * Touching on the left of the display switches main items 1 item at a time.
 - Touching on the left of the display switches sub-items continuously.
 - * Touching on the center of the display switches the sub-items 1 item at a time. Touching switches sub-items continuously.
3. When "EDIT" is displayed at the right of the display, touch EDIT to switch to the adjustment details display.
4. Either touch on the right of the display, or turn the [ROTARY] knob to set the details.

■ To return to the original mode

1. Press the [A] button again.

● Setting items

Main Item	Sub-item
DISPLAY	CLOCK • Clock setting (cf. page 36)
	SCREEN SVR • Screen saver setting (cf. page 36)
	MSG INPUT • Message information input (cf. page 37)
	MESSAGE • Message display setting at power ON/OFF (cf. page 37)
	S/A SENS • Setting the Spectrum analyzer sensitivity (cf. page 38)
	SCROLL • Adjusting the scroll speed (cf. page 38)
APPERNCE	DIMMER IN • Auto-dimmer setting (cf. page 38)
	DMR LEVEL • Setting the dimmer level (cf. page 38)
	CONTRAST • Adjusting the display contrast (cf. page 39)
	BLINK LED • Making the LED blink when DCP is removed (cf. page 39)
	BEEP • Setting beep (cf. page 39)
SOUND	AC-PRO III • Selecting the VSE mode (STD/PRO) (cf. page 39)
	EQ SELECT • Selecting the equalizer mode (cf. page 39)
	SP-SETTING • Setting the speaker configuration (cf. page 40)
	CENTER-SP / SUB-WOOFER • Setting sub-woofer speaker ON/OFF (cf. page 40)
	HPF / SUB-W LPF • Adjusting the speaker filter frequency (cf. page 41)
	AMP CANCEL • Setting internal amplifier use ON/OFF (cf. page 41)
	SP GAIN • Adjusting the speaker output level (cf. page 41)
PL II DELAY	SRD-SP • Adjusting the rear speaker delay time (cf. page 42)
PL II CONT	PANORAMA / DIMENSION / CTR WIDTH • Setting the music mode in detail (cf. page 42)
TUNER	TV ARER • Setting the TV area (cf. page 51)
	TV DIVER • Setting TV diversity (cf. page 51)
SETTING	AUX SENS • Setting the portable audio (AUX) input level (cf. page 43)
	SYSTEM CHECK • Performing a system check (cf. page 43)
	CODEMATIC • Setting security (cf. page 44)

Operations Common to Each Mode

Setting the clock (CLOCK)

When the power is turned OFF with the clock displayed, the clock remains displayed even if this unit is turned off as long as the car engine is running (ACC is ON).
The clock is displayed in 12-hour format.

1. Press the [A] button.
2. Touch on the setting item display to select "CLOCK" under "DISPLAY".



3. Touch EDIT.
The time ("e.g. "PM 2: 20") currently set on this unit is displayed, and the mode changes to the time setting mode.



* If you operate another button while you are setting the time, the time is not adjusted.

4. Touch on the center of the display to set hours.
5. Either touch on the right of the display, or turn the [ROTARY] knob to set minutes.
6. Touch SET.
* You will hear a long beep, and the time is set.

Notes:

- The clock cannot be adjusted when the power is OFF.
- When the battery has been removed for maintenance or for repair, set the time again.

7. Press the [A] button to return to the original mode.

Setting the screen saver (SCREEN SVR)

This function allows you display a screen saver when you have not operated this unit for about 30 seconds.

- The factory default setting is "ON".
1. Press the [A] button to set to the adjust mode.
 2. Touch on the setting item display to select "SCREEN SVR" under "DISPLAY".



3. Either touch on the right of the display, or turn the [ROTARY] knob to select "ON" or "OFF".
4. Press the [A] button to return to the original mode.

■ To switch the screen saver display

Touch PREV or NEXT while the screen saver is displayed.

Each touch of these buttons switches the screen saver display.

● Screen savers

Screen saver pattern 1

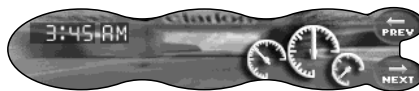

Screen saver pattern 2

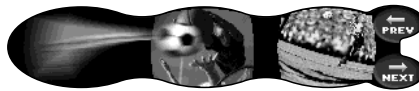

Screen saver pattern 3

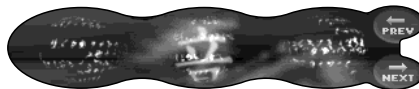

Spectrum analyzer pattern 1



Spectrum analyzer pattern 2

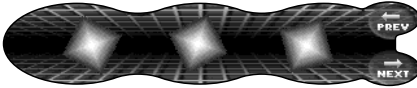

Spectrum analyzer pattern 3



Spectrum analyzer pattern 4



Message information



SS SCAN

The above 8 indications are displayed for about 10 seconds each.

Entering messages to display in message information (MSG INPUT)

1 type of screen saver is available. For details on how to switch the screen saver display, see "Setting the screen saver" (cf. page 36).

- Up to 30 characters can be entered.
- The factory default setting is "Welcome to Optimedia".

1. Press the [A] button to set to the adjust mode.
2. Touch on the setting item display to select "MSG INPUT" under "DISPLAY".



3. Touch EDIT.
The mode changes to the message entry mode.

4. Touch on the center of the display to determine the entry position.
* To clear the message, touch and hold the center of the display for 2 seconds or longer.
If you perform the operation at step 8 with the message cleared, the message returns to its factory default setting.
5. Touch on the left of the display to select the type of text.
Each touch of switches the type of text. For details, see page 32.
6. Either touch on the right of the display, or turn the [ROTARY] knob to determine the entered characters.
7. Repeat steps 4 to 6 to enter the message.
8. Touch and hold MEMO for 2 seconds or longer.
You will hear a long beep, and the message is stored in memory.
9. Press the [A] button to return to the original mode.

Displaying messages (MESSAGE)

This function allows you to display messages on the display when the power is turned ON/OFF. "Hello" is displayed when the power is turned ON, and "See you" is displayed when power is turned OFF.



- The factory default setting is "ON".
1. Press the [A] button to set to the adjust mode.
 2. Touch on the setting item display to select "MESSAGE" under "DISPLAY".





3. Either touch on the right of the display, or turn the [ROTARY] knob to select "ON" or "OFF".
4. Press the [A] button to return to the original mode.

Setting the sensitivity of the spectrum analyzer (S/A SENS)

This function allows you to adjust the sensitivity (amount of deflection) of the spectrum analyzer. For details on displaying the spectrum analyzer, see “Switching the display” (cf. page 13) or “Setting the screen saver” (cf. page 36).



- The factory default setting is “MID”.
1. Press the [A] button to set to the adjust mode.
 2. Touch   on the setting item display to select “S/A SENS” under “DISPLAY”.





3. Either touch   on the right of the display, or turn the [ROTARY] knob to adjust the sensitivity.
 - * Select either LOW (small deflection amount), MID or HIGH (large deflection amount).
4. Press the [A] button to return to the original mode.

Adjusting the display scroll speed (SCROLL)

This feature allows you to slow down the scroll speed when the scroll speed is too fast, making it difficult to view the screen.

- The factory default setting is “SPEED 2”.
1. Press the [A] button to set to the adjust mode.
 2. Touch   on the setting item display to select “SCROLL” under “DISPLAY”.





3. Either touch   on the right of the display, or turn the [ROTARY] knob to adjust the sensitivity.
 - * This setting item can be adjusted within the range SPEED 1 to SPEED 7. Adjust this setting item while viewing how the appearance of the display changes.

4. Press the [A] button to return to the original mode.



Setting the auto-dimmer (DIMMER IN)

This function allows you to dim the lighting of the display matched to the illumination or the brightness inside your car.

- Select either “AUTO” (interlocked to the brightness inside your car) or “ILLUMI” (interlocked to the illumination inside your car) as the auto-dimmer setting.
- When the auto-dimmer function is set to “AUTO”, the brightness of the display is dimmed according to the brightness detected by this sensor.
- Set the dimmer setting at DMR LEVEL.
- The factory default setting is “AUTO”.



1. Press the [A] button to set to the adjust mode.
2. Touch   on the setting item display to select “DIMMER IN” under “APPERNCE”.





3. Either touch   on the right of the display, or turn the [ROTARY] knob to select “AUTO” or “ILLUMI”.
4. Press the [A] button to return to the original mode.

Setting the dimmer level (DMR LEVEL)

This function allows you to set how much the displayed is to be dimmed.

- The factory default setting is “3”.
1. Press the [A] button to set to the adjust mode.
 2. Touch   on the setting item display to select “DMR LEVEL” under “APPERNCE”.



3. Either touch   on the right of the display, or turn the [ROTARY] knob to set the dimmer level.

* Select one of OFF (dimming OFF, bright), 1 (slightly dimmed) to 5 (dark).

4. Press the [A] button to return to the original mode.

Adjusting the contrast of the display (CONTRAST)

You can adjust the contrast of the display to match the mounting angle of the unit.

- The factory default setting is “6”.
1. Press the [A] button to set to the adjust mode.
 2. Touch on the setting item display to select “CONTRAST” under “APPERNCE”.



3. Either touch on the right of the display, or turn the [ROTARY] knob to adjust the contrast.
 - * This setting item can be adjusted within the range 1 to 11.
 - Adjust this setting item while viewing how the appearance of the display changes.
4. Press the [A] button to return to the original mode.

Making the LED blink when DCP is removed (BLINK LED)

You can make the LED on this unit blink when the DCP is removed.

- The factory default setting is “OFF”.
1. Press the [A] button to set to the adjust mode.
 2. Touch on the setting item display to select “BLINK LED” under “APPERNCE”.



3. Either touch on the right of the display, or turn the [ROTARY] knob to select “ON” or “OFF”.
4. Press the [A] button to return to the original mode.

Setting the beep for when buttons are operated (BEEP)

The short or long high-pitched tone you hear when a button is operated is called a “BEEP”.

- The factory default setting is “ON”.
1. Press the [A] button to set to the adjust mode.
 2. Touch on the setting item display to select “BEEP” under “APPERNCE”.



3. Either touch on the right of the display, or turn the [ROTARY] knob to select “ON” or “OFF”.
4. Press the [A] button to return to the original mode.

Selecting each mode

This item cannot be selected when the Dolby Pro Logic II is set to “MUSIC” or “MATRIX” (cf. page 17).

- The factory default setting is “PRO” for AC-PROIII and “P.EQ” for EQ SELECT.

■ AC-PROIII

When “STD” (standard mode) is selected, the sound quality and field can be adjusted by VSE (Virtual Space Enhancer) so that the same audio effect can be obtained whichever seat you are sitting in.

When “PRO” (PRO mode) is selected, the sound quality and field can be adjusted in detail for each seating position.

■ EQ SELECT

When “P.EQ” (equalizer mode) is selected, the entire frequency level range can be compensated by a detailed smooth curve.

When “BAS/TREB” (bass/treble mode) is selected, the frequency level can be compensated by dividing it into 2 major levels, bass (low tones) and treble (high tones).

1. Press the [A] button to set to the adjust mode.

Operations Common to Each Mode

- Touch on the setting item display to select “AC-PROIII” under “SOUND” and “EQ SELECT” under “SOUND”.



- Either touch on the right of the display, or turn the [ROTARY] knob to select the mode.

Mode selection

AC-PRO III	STD
	• Standard mode (VSE menu)
EQ SELECT	PRO
	• PRO mode (position menu)
EQ SELECT	P.EQ
	• Equalizer mode (P.EQ menu)
EQ SELECT	BAS/TREB
	• Bass/treble mode

- Press the [A] button to return to the original mode.

Setting the speaker configuration (SP-SETTING)

Set to match the speaker configuration of your car to fully bring out the audio characteristics of this unit.

- The factory default setting is “SW + SW ”.
- Press the [A] button to set to the adjust mode.
 - Touch on the setting item display to select “SP-SETTING” under “SOUND”.



- Either touch on the right of the display, or turn the [ROTARY] knob to set the speaker configuration.

Speaker configuration

CTR+SW 5.1ch configuration	Front/rear speakers (4ch) Center speaker (1ch) Sub-woofer (1ch)
SW + SW 4ch+sub-woofer configuration	Front/rear speakers (4ch) Sub-woofer (2ch)

Notes:

- Sound is not output from the center speaker unless the following settings are made when “CTR+SW” is set.
 - Referring to “Selecting the PLLII menu” (cf. page 17), set the Dolby Pro Logic II mode to “MUSIC” or “MATRIX”.
 - Referring to “Setting speakers ON/OFF” (cf. page 40), set the center speaker to “ON”.
 - Sound is not output from the sub-woofer Lch when “SW + SW ” is set and the Dolby Pro Logic II mode is set to “MUSIC” or “MATRIX”.
- Press the [A] button to return to the original mode.

Setting speakers ON/OFF (CENTER-SP/SUB-WOOFER)

Set the center speaker (CENTER-SP) and sub-woofer (SUB-WOOFER) ON/OFF.

Be sure to set this setting to “OFF” when there is no center speaker or sub-woofer.

- The center speaker (CENTER-SP) can be set when the Dolby Pro Logic II mode is set to “MUSIC” or “MATRIX”, and “SP-SETTING” is set to “CTR-SW”.
- The factory default setting is “ON”.

- Press the [A] button to set to the adjust mode.
- Touch on the setting item display to select “CENTER-SP” under “SOUND” and “SUB-WOOFER” under “SOUND”.



- Either touch on the right of the display, or turn the [ROTARY] knob to select “ON” or “OFF”.
- Press the [A] button to return to the original mode.

Adjusting the filter frequencies of speakers (HPF/SUB-W LPF)

This function allows you to adjust the filter frequency matched to the speakers you are using.

- The filters (HPF/SUB-W LPF) that you can use differ according to the Dolby Pro Logic II mode setting.

Dolby Pro Logic II mode setting	Filter	
	MUSIC / MATRIX	Not adjustable
OFF	Adjustable	Adjustable

*1 Adjustment is possible only when "SUB-WOOFER" is set to "ON".

- The factory default setting is "THROUGH".

Filter adjustment

● HPF (high-pass filter adjustment)

This filter cuts bass sound from the front and rear speakers.

THROUGH → 50Hz → 80Hz → 120Hz

Set the filter matched to the speaker when small-diameter speakers are used.

THROUGH

Set this when using speakers that can generate bass.

● SUB-W LPF (sub-woofer low-pass filter adjustment)

This filter cuts treble sound from the sub-woofer.

THROUGH → 50Hz → 80Hz → 120Hz

Set the filter frequency to match the sub-woofer.

THROUGH

Set this when a low-pass filter built-in powered sub-woofer is used.

- Press the [A] button to set to the adjust mode.
- Touch on the setting item display to select "HPF" under "SOUND" and "SUB-W LPF" under "SOUND".



- Either touch on the right of the display, or turn the [ROTARY] knob to set the frequency.

* Select one of THROUGH, 50Hz, 80Hz, and 120Hz.

- Press the [A] button to return to the original mode.

Setting internal amplifier use ON/OFF (AMP CANCEL)

Set internal amplifier use ON/OFF matched to whether or not an external amplifier is used.

Set AMP CANCEL to "ON" (internal amplifier use OFF) when an external amplifier is connected and the internal amplifier is not used.

- The factory default setting is "OFF" (internal amplifier used).

- Press the [A] button to set to the adjust mode.
- Touch on the setting item display to select "AMP CANCEL" under "SOUND".



- Either touch on the right of the display, or turn the [ROTARY] knob to select "ON" or "OFF".
- Press the [A] button to return to the original mode.

Adjusting the output level of the speakers (SP GAIN)

Use the test tone function built into this unit to adjust so that the volume that is output from all speakers is the same.

- This item can be set only when the Dolby Pro Logic II mode is set to "MUSIC" or "MATRIX".
- The factory default setting is "0dB".

- Press the [A] button to set to the adjust mode.
- Touch on the setting item display to select "SP GAIN" under "SOUND".



- Touch EDIT. The mode changes to the SP GAIN adjustment mode.

Operations Common to Each Mode

- Touch on the adjustment item display to select the desired item.
Each touch of switches the adjustment item as follows:

Adjustment items

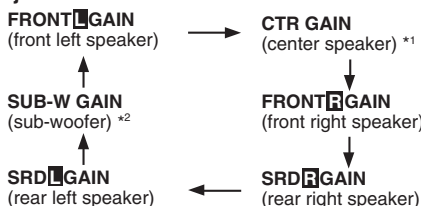

*1 "CTR GAIN" is displayed only when "SP-SETTING" is set to "CTR+SW" and "CENTER-SP" is set to "ON".

*2 "SUB-W GAIN" is displayed only when "SUB-WOOFER" is set to "ON".

- Either touch on the right of the display, or turn the [ROTARY] knob to adjust the output level.
The output level can be adjusted within the range -10 dB to +10 dB
- Repeat steps 4 and 5 to adjust each item.
- Press the [A] button to return to the original mode.

Adjusting the delay time of the rear speaker (PL II DELAY)

The timing that sound arrives at the listening position differs according to the mounting position of the rear speakers and the size of your car. If you adjust the delay time of the rear speakers, you can adjust so that sound from the rear speakers can be heard at the same timing as output from the front speakers.

- This item can be set only when the Dolby Pro Logic II mode is set to "MUSIC" or "MATRIX".
- The factory default setting is "0ms".

- Press the [A] button to set to the adjust mode.
- Touch on the setting item display to select "SRD-SP" under "PL II DELAY".



- Either touch on the right of the display, or turn the [ROTARY] knob to adjust the delay time.
* "SRD-SP" can be adjusted within the range 0 ms to 15 ms.
- Press the [A] button to return to the original mode.

Setting the music mode in detail (PL II CONT)

This function allows you to set the music mode in more detail when the Dolby Pro Logic II mode is set to "MUSIC".

- This item can be set only when the Dolby Pro Logic II mode is set to "MUSIC".
- The factory default setting for PANORAMA is "NO", for DIMENSION is "3" and for CTR WIDTH is "3".

Adjustment items

PANORAMA (panorama control setting)

This widens the soundfield image at the front up to the rear speakers. Set this item to "YES" if you feel that there is no surround effect.

DIMENSION (dimension setting)

Shifts the soundfield image to the front or the rear. When the soundfield image inclines to either the front or the rear, this inclination can be compensated.

Adjustment value 3 is the center position.

Adjustment values 2 to 0 shift the soundfield image to the rear, while adjustment values 4 to 6 shift the soundfield image to the front.

CTR WIDTH (center width setting)*1

Adjusts the fixed position of the center channel between the center speaker and L/R front speakers.

When the center sound is divided equally to the left and right, the entire soundfield image increases to produce a naturally expanding feeling.

Adjustment value 0 plays back all center sounds on the center speaker.

Adjustment value 7 divides the center sound equally between the L/R front speakers.

*1 "CTR WIDTH" is displayed only when "SP-SETTING" is set to "CTR+SW" and "CENTER-SP" is set to "ON".

- Press the [A] button to set to the adjust mode.

2. Touch  on the setting item display to select the desired adjustment item under “**PL II CONT**”.
The adjustment items are “**PANORAMA**”, “**DIMENSION**” and “**CTR WIDTH**”.



3. Either touch  on the right of the display, or turn the [ROTARY] knob and adjust the item as desired.
* Select “**YES**” or “**NO**” for “**PANORAMA**”.
* “**DIMENSION**” can be adjusted within the range 0 to 6.
* “**CTR WIDTH**” can be adjusted within the range 0 to 7.
4. Press the [A] button to return to the original mode.

AUX function

This system has an external RCA input so you can listen to sounds and music from external devices connected to this unit.

Setting the input level (AUX SENS) of portable audio (AUX mode)

This function allows you to set the input level of optional external devices connected to this unit.

- The factory default setting is “**MID**”.
1. Press the [A] button to set to the adjust mode.
 2. Touch  on the setting item display to select “**AUX SENS**” under “**SETTING**”.



3. Either touch  on the right of the display, or turn the [ROTARY] knob to set the input level.
* Select one of **LOW**, **MID** or **HIGH**.
4. Press the [A] button to return to the original mode.

Performing a system check

This function allows you to perform a system check from the adjust mode when required.

1. Press the [A] button to set to the adjust mode.
2. Touch  on the setting item display to select “**SYSTEM CHECK**” under “**SETTING**”.



3. Touch and hold **START** for 1 second or longer.
“**System Check**” appears on the display.
4. Press the [ROTARY] knob.
The system check starts.
When the system check is complete, “**Completed**” appears on the display.
5. Press the [ROTARY] knob again.
The main display for the radio mode appears.

Using the security function (CODEMATIC)

This function prevents persons who do not know the touch sequence from easily operating this unit. The Touch Code display appears when DCP is attached and the power is turned ON with "CODEMATIC" set to "ON".



If you touch the display in this screen in the preset order, "SUCCESSFUL" is displayed and the power is turned OFF.

When the power is next turned ON, the Touch Code display does not appear, and the main display in the radio mode or CD mode is displayed.

1. Press the [A] button to set to the adjust mode.
2. Touch  on the setting item display to select "CODEMATIC" under "SETTING".



2 types of items are displayed for "CODEMATIC", items for which "ON" or "OFF" is displayed at the right of the screen, and items for which "INPUT" is displayed at the right of the screen. Here, select the item for which "ON" or "OFF" is displayed at the right of the display.

3. Either touch  on the right of the display, or turn the [ROTARY] knob to select "ON" or "OFF".
4. Touch  on the setting item display to select "CODEMATIC" under "SETTING". Here, select the item for which "INPUT" is displayed at the right of the display.
5. Touch INPUT.
The Touch Code display appears.

6. Enter the touch code.
 - * Touch one of 5 locations (left, center, right, top right, or bottom right) of the display. Each touch of the display lights one of the Touch Code indicators.
 - * For example, touch (1) center, (2) top right, (3) left, and (4) bottom right, in that order. You can also repeatedly touch the same location.

When you touch 4 times, and 4 indicators light, you will hear a long beep, and the original mode is returned to.

■ To cancel CODEMATIC

If you have forgotten the touch order, either touch ① bottom right, ② left, ③ top right and then ④ right in that order, or press [SCN] on the remote control unit.

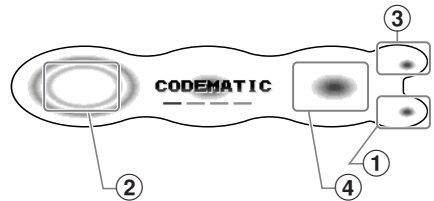

8. OPERATIONS OF ACCESSORIES

CD Changer Operations

CD changer

When an optional CD changer is connected through the CeNET cable, this unit can control CD changer operations. This unit can be connected to a total of 2 CeNET-wired CD changers.

DVD changer

When an optional DVD changer is connected through the CeNET cable, this unit can control DVD changer operations. To view a DVD, an optional monitor is required.

Operation and display of the DVD changer on this unit is a simplified version, and does not support all DVD changer functions. For operating the DVD changer, use the remote control unit that is provided with the DVD changer. For details, refer to the User's Manual provided with the DVD changer.

■ When 2 CD changers are connected

Press the [ROTARY] knob to select the changer connected to this unit. (Each press of the [ROTARY] knob switches the changer.)

- If the CD changer does not contain a magazine, "NO MAG" is displayed, and if the magazine does not contain a CD, "NO DISC" is displayed.
- For details on the title display, see "Switching the title display" (cf. page 14).

Screen displays in the changer mode

■ Main display (CD changer mode)

This is displayed by pressing the [ROTARY] knob to select the CD changer mode.

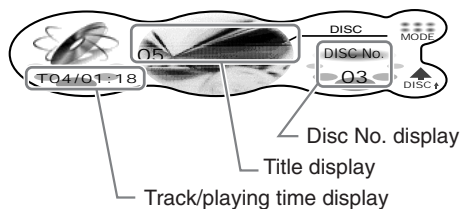

Touching the left of the display for 1 second or longer switches the simple operation display.

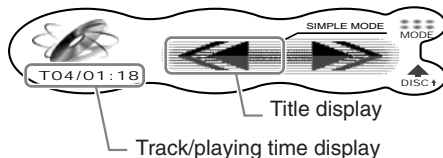

Track/playing time display

T01/02: 00: The No. of the track currently being played and the playing time are displayed.

Touching \uparrow \downarrow \uparrow or \leftarrow \rightarrow in the standard operation display allows you to select the track to play, or fast-forward/back-forward tracks.

Title display

Touching this switches the display.

Disc No. display

If you touch \uparrow \downarrow \uparrow in the standard operation display, you can select a disc.

MODE

Touching this displays sub-functions. Touching and holding this for 1 second or longer displays the disc list.

T-SCAN/D-SCAN

This is displayed during scan play. Touching T-SCAN/D-SCAN ends scan play.

T-RPT/D-RPT

This is displayed during repeat play. Touching T-RPT/D-RPT ends repeat play.

T-RDM/D-RDM

This is displayed during random play. Touching T-RDM/D-RDM ends random play.

DISC \uparrow

Touching this starts play of the next disc.

◀▶ (only in the simple operation display)

Touching these selects the track to play.

Touching and holding these fast-forwards/fast-backwards tracks.

CD Changer Operations

■ Disc list display (CD changer mode)

This is displayed by touching and holding MODE for 1 second or longer in the main display.



>> : Selection in progress

Touching a disc name returns the screen to the main display, and play starts from the first track in the disc you touched.

← PREV-RTN:

Touching this displays the previous title list. Touching and holding this for 1 second or longer returns the screen to the main display.

→ NEXT:

Touching this displays the next title list.

⚠ CAUTION

CD-ROM discs cannot be played from every CD changer. This depends on the model.

Note:

- Some CDs recorded in the CD-R/CD-RW mode may not be usable.

Selecting the changer mode

1. Press the [ROTARY] knob to select the changer mode.
 - * The mode of equipment that is not connected is not displayed. Play starts automatically when the mode changes to the changer mode.

Pausing play

1. Press the [▶||] button.

■ To resume play

1. Press the [▶||] button again.

Selecting a CD

1. Touch on the disc No. display to select a disc. Play starts.
 - * If magazine does not contain the disc you selected, the No. for that disc is not displayed.
 - * Touching DISC starts play of the next disc.

■ To select a disc from the disc list display

1. Touch and hold MODE for 1 second or longer. The disc list is displayed. If you touch NEXT, the next part of the disc list is displayed.
2. Touch the disc name.
 - * If magazine does not contain the disc you selected, "NO DISC" is displayed for that disc No.
 - * If you selected the same disc as that currently being played, play returns to and starts from the first track on that disc. (top function)

Selecting a track

1. To listen to the next track, touch on the track display.
2. To listen to the previous track, touch twice on the track display. Touching plays the next track. If you touch more times, the track advances ahead to the track for the number of times you touched and that track is played. Touching plays the previous track. If you touch more times, the track moves back to the track for the number of times you touched and that track is played.
 - * If you touch twice on the track display while the start of the track is being played, the track 2 tracks back is sometimes played.

Fast-forward/Fast-backward

1. To fast-forward, touch on the track display.
2. To fast-backward, touch on the track display.

Top function

The top function starts play from the first track on the disc currently being played.

1. Touch and hold MODE for 1 second or longer.
The disc list is displayed. If you touch NEXT, the next part of the disc list is displayed.
2. Touch the disc name.
 - * If magazine does not contain the disc you selected, "NO DISC" is displayed for that disc No.
 - * If you selected the same disc as that currently being played, play returns to and starts from the first track on that disc.

Scan play

Scan play locates and plays the first 10 seconds of each track on a disc automatically. This function continues on the disc until it is canceled.

The scan play function is useful when you want to select a desired track.

1. Touch MODE.
2. Touch T-SCAN.
The MODE display changes to "T-SCAN" and scan play starts.
 - * Scan play starts from the next track after the track currently being played.

■ To cancel scan play

1. Touch T-SCAN.
The T-SCAN display changes to "MODE", and the track that was playing when you touched T-SCAN is played.

Disc scan play

Disc scan play locates and plays the first 10 seconds of the first track on each disc in the currently selected CD changer. This function continues automatically until it is canceled.

Disc scan play is useful when you want to select a desired CD.

1. Touch MODE.
2. Touch D-SCAN.
The MODE display changes to "D-SCAN" and disc scan play starts.
 - * Disc scan play starts from the next disc after the disc currently being played.

■ To cancel disc scan play

1. Touch D-SCAN.
The D-SCAN display changes to "MODE", and the track that was playing when you touched D-SCAN is played.

Repeat play

Repeat play continuously plays the current track. This function continues automatically until it is canceled.

1. Touch MODE.
2. Touch T-REPEAT.
The MODE display changes to "T-RPT" and repeat play is started.

■ To cancel repeat play

1. Touch T-RPT.
The T-RPT display changes to "MODE", and regular play starts from the track that was playing when you touched T-RPT.

Disc repeat play

After all the tracks on the current disc have been played, disc repeat play automatically replays the current disc over from the first track. This function continues automatically until it is canceled.

1. Touch MODE.
2. Touch D-REPEAT.
The MODE display changes to "D-RPT" and disc repeat play is started.

■ To cancel disc repeat play

1. Touch D-RPT.
The D-RPT display changes to "MODE", and regular play starts from the track that was playing when you touched D-RPT.

Random play

Random play selects and plays individual tracks on the disc in no particular order. This function continues automatically until it is canceled.

1. Touch MODE.
2. Touch T-RANDOM.
The MODE display changes to "T-RDM" and random play starts.

■ To cancel random play

1. Touch T-RDM.
The T-RDM display changes to "MODE", and regular play starts from the track that was playing when you touched T-RDM.

Disc random play

The disc random play selects and plays individual tracks or discs automatically in no particular order. This function continues automatically until it is canceled.

1. Touch MODE.
2. Touch D-RANDOM.
The MODE display changes to "D-RDM" and random play starts.

■ To cancel disc random play

1. Touch D-RDM.
The D-RDM display changes to "MODE", and regular play starts from the track that was playing when you touched D-RDM.

TV tuner function

When an optional TV tuner is connected through the CeNET cable, this unit controls all TV tuner functions. To watch TV, you need a TV tuner and a monitor.

Screen displays in the TV mode

■ Main display

This is displayed by pressing the [ROTARY] knob to select the TV mode.

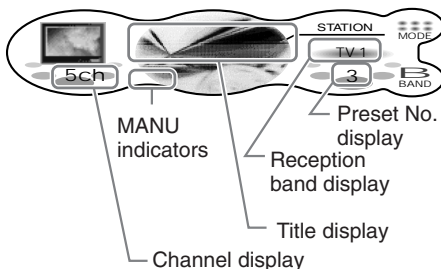

Touching the left of the display for 1 second or longer switches the simple operation display.

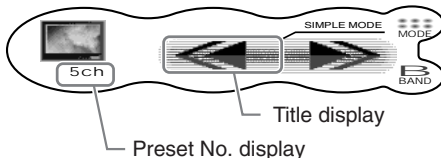

Channel display

1ch: The channel currently being received is displayed.

Touching \uparrow \downarrow \leftarrow or \rightarrow in the standard operation display allows you to perform seek tuning or manual tuning.

Title display

3ch: The name of the station currently being received is displayed.

VTR: In video mode

Touching these switches the display.

Reception band display

TV1: Band name

Preset No. display

Touching \uparrow \downarrow \leftarrow \rightarrow in the standard operation display selects a preset memory.

MODE

Touching this displays sub-functions. Touching and holding this for 1 second or longer displays the preset memory list.

P-SCAN: This is displayed during a preset scan. Touching this ends the preset scan.

A-STORE: This is displayed during an auto-store. Touching this ends the auto-store.

BAND

Touching this switches the reception band.

Touching and holding this for 1 second or longer toggles between the manual tuning mode and the seek tuning mode.

◀▶ (only in the simple operation display)

Touching these buttons enables seek tuning or step tuning (in the manual tuning mode).

Touch and holding these buttons enables quick tuning (in manual tuning mode).

■ Preset memory list display

This is displayed by touching and holding MODE for 1 second or longer in the main display.

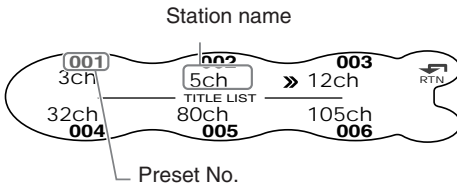

>> :
Tuning in progress

RTN :
Touching this returns the display to the main display.

Selecting the TV mode

1. Press the [ROTARY] knob to select the TV mode.
Each press of the [ROTARY] knob switches the mode as follows:
 - * The mode of equipment that is not connected is not displayed.

Switching the reception band

1. Touch BAND to switch the reception band.
Each touch of BAND switches the reception band.

TV1 → TV2 → TV1...

Seek tuning

Seek tuning is a function for automatically tuning stations with good reception.

1. Touch and hold BAND for 1 second or longer while MANU is displayed.
Automatic tuning is possible when MANU disappears.
2. Touch ◀▶ on the channel display.
SEEK UP/SEEK DOWN is displayed, and tuning starts. Tuning automatically stops at stations with good reception.

■ To cancel tuning

1. Touch ◀▶ on the channel display again.

Manual tuning



There are 2 ways available: quick tuning and step tuning.

When you are in the step tuning mode, the frequency changes 1 step at a time. In the quick tuning mode, you can quickly tune the desired frequency.

1. Touch and hold BAND for 1 second or longer while MANU is not displayed.
Manual tuning is possible when MANU is displayed.
2. Operate the channel display to tune to a channel on which there is a broadcast.
There are 2 manual tuning methods: step tuning and quick tuning.
 - * Step tuning is a function for switching the channel 1 step at a time.
Touch ⬆️⬆️ on the frequency display.
 - * Quick tuning is a function for switching the channel continuously.
Touch ◀▶ at the channel display.
Tuning stops when you take your finger away from the panel.

Recalling a preset station

This function allows the user to select a preset station.

1. Touch and hold MODE for 1 second or longer.
The preset memory list is displayed.
2. Touch the station you want to listen to.
* The station can also be tuned by touching   at a preset No.

■ To cancel tuning

1. Touch RTN.

Preset memory

A total of 12 TV stations can be stored (6-TV1 and 6-TV2). This allows you to select your favorite TV stations and store them in memory for later recall.

1. Touch BAND to switch the reception band.
2. Operate the channel display to select the station to store to.
3. Touch and hold MODE for 1 second or longer.
The preset memory list is displayed.
4. Touch and hold the preset No. to store for 2 seconds or longer.
You will hear a long beep, and the station is stored in memory.
If you hear a short beep, the station is not stored to memory. Repeat the procedure from step 1.

Auto store

Auto store selects 6 TV stations automatically and stores each one into preset memory.

If there are not 6 stations with good reception, stations previously stored in memory remain and only the strong stations are stored into memory.

1. Touch MODE.
2. Touch and hold A-STORE for 2 seconds or longer.
The MODE display changes to “**A-STORE**” and the preset No. in the auto-store operation appears on the preset No. display.

* Stations with good reception are automatically searched, and are stored to preset memory (No.1 to No.6) in order from the station having the lowest frequency.

Notes:

- When auto store is performed, stations stored to memory so far are cleared.
- When there are fewer than 6 stations with good reception, low frequencies are automatically returned to, and auto store is performed again. If there are fewer than 6 stations even after auto store is performed twice, stations stored so far remain in memory.

Preset scan

Preset scan is a function for receiving stations in the order that they are currently stored to preset Nos. so that broadcasts can be checked.

1. Touch MODE.
2. Touch P-SCAN.
The MODE display changes to “**P-SCAN**” and the preset No. in the preset scan operation is displayed in the preset No. display.
* The currently stored stations are received in order for 7 seconds or longer each. Stations with poor reception are skipped, and the next station is received.
TV stations are received as follows:
TV1 (1 → 6) → TV2 (1 → 6) → and so forth.

■ To cancel the preset scan

1. Touch P-SCAN.
The P-SCAN display changes to “**MODE**”, and the stations that were being received when P-SCAN was touched are received next.

Watching a video

The TV tuner has a VTR input terminal to which 1 external device can be connected. Connect a 12 V video cassette player (VCP) or video cassette recorder (VCR) to the TV tuner input terminal.

1. Press the  button.
VTR is displayed, and the mode is switched to the VTR mode.
* The TV screen enters the video input mode, and videos can be viewed.

■ To return to the TV mode

1. Press the [▶||] button again.

Setting the TV area (TV AREA)

When you select the TV area (TV reception area), the TV tuner area setting changes.

1. Press the [A] button to set the adjust mode.
2. Touch on the setting item display to select "TV AREA" under "TUNER".



3. Either touch on the right of the display, or turn the [ROTARY] knob to select the area.
4. Press the [A] button to return to the previous mode.

The above operations are required when a TV tuner other than TTX7501z is connected.

Setting the TV diver (TV DIVER)

You can change the reception setting for the TV antenna connected to the TV tuner.

- Set this item to "OFF" when a TV diversity antenna is not in use.
 - The factory default setting is "ON".
1. Press the [A] button to set to the adjust mode.
 2. Touch on the setting item display, and select "TV DIVER" under "TUNER".



3. Either touch on the right of the display, or turn the [ROTARY] knob to select "ON" or "OFF".
4. Press the [A] button to return to the original mode.

5.1ch Surround Decoder Operations

When an optional CeNET wiring-compatible 5.1ch surround decoder is connected, the 5.1ch surround decoder can be controlled on this unit.

The following functions change when a 5.1ch surround decoder is connected:

- Two modes "MOVIE" and "VIRTUAL" are added to the Dolby Pro Logic II mode.
- The VSE/POSITION mode is changed to the DSF (Digital Sound Field) mode.
- In the P.EQ (Parametric Equalizer) mode, the settings of each speaker can be adjusted in even more detail.
- Settings relating to music in setting items (cf. page 34) are changed.

Selecting PL II (Dolby PL II)

Select one of the available four modes matched to the source you are to play as the Dolby Pro Logic II mode.

- The factory default setting is "OFF".

■ MUSIC (Music mode)

See "Selecting the PLII menu (Dolby PLII)" (cf. page 17).

■ MATRIX (Matrix mode)

See "Selecting the PLII menu (Dolby PLII)" (cf. page 17).

■ MOVIE (Movie mode)

Suitable for DVD video movies.

■ VIRTUAL (Virtual mode)

Suitable for movies and other audio sources.

■ OFF

The Dolby Pro Logic II mode is not used.

1. Press the [SOUND] button.
2. Touch Dolby PLII.



5.1ch Surround Decoder Operations

- Touch on the right of the display to select the Dolby Pro Logic II mode.

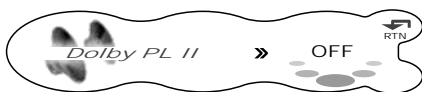

The mode display is switched as follows:

MUSIC (music mode) → MATRIX (matrix mode) → MOVIE (movie mode) → VIRTUAL (virtual mode) → OFF (PL II off) → MUSIC (music mode)...

* For details on the volume adjustment of the center speaker/sub-woofer, see page 40.

- Touch RTN.

Selecting the DSF menu

DSF (Digital Sound Field) makes it possible through sound simulation to enjoy the acoustic experience you would have in a concert hall or live performance hall.

- The factory default setting for DSF is “**OFF**” and for the DSF menu is “**HALL**”.
- When the DSF menu is selected, the volume sometimes decreases.

- Press the [SOUND] button.
- Touch DSF.



- Touch on the ON/OFF display. The DSF effect is toggled ON/OFF.



When DSF is set to “**OFF**”, the DSF setting is not reflected on the music source. This completes the DSF setting. Press the [SOUND] button to return to the original mode.

- Touch on the DSF menu No. to select the desired DSF menu.



DSF menus

HALL → CHURCH → STADIUM → LIVE → JAZZCLUB → THEATER → HALL...

No.	Function Name	Discription
1	HALL	Large concert hall
2	CHURCH	Church with a vaulted ceiling
3	STADIUM	Large stadium without roof or walls
4	LIVE	Live performance hall, larger than a jazz club
5	JAZZCLUB	Jazz club with a low ceiling
6	THEATER	Movie or drama theater

- Press the [SOUND] button to return to the original mode.

Selecting the Parametric Equalizer menu

Parametric Equalizer (P.EQ) allows you to compensate the entire frequency level range in detail by smooth curve using frequency compensation matched to the type of your car.

- The factory default setting provides the following settings for all speakers. FREQ = 1kHz, Q = 1, GAIN = 0dB

- Press the [SOUND] button.
- Touch P.EQ.



- Touch on the ON/OFF display. The P.EQ effect is toggled ON/OFF.



When the P.EQ effect is set to “OFF”, the P.EQ setting is not reflected on the music source. This ends the P.EQ setting. Press the [SOUND] button to return to the original mode.

- Touch  on the P.EQ menu No. to select the P.EQ menu.



P.EQ menus

SIGNAL → **SP-SEL** → **BAND** → **FREQ** → **Q**
→ **GAIN** → **SIGNAL...**

- Touch  on the right on the display and adjust the item as desired.

SIGNAL (selects the adjustment signal):

- Selects “**P-NOIS**” or “**MUSIC**”
- **P-NOIS**: set when pink noise is to be used
- **MUSIC**: set to use music signals

SP-SEL (selects the speakers whose P.EQ value is to be adjusted):

Select one of “**FRONT**”, “**CENTER**” or “**SURROUND**”.

- **FRONT**: front speaker
- **CENTER**: center speaker
- **SURROUND**: surround speaker

BAND (selects the frequency band):

Select one of band 1 to 3

FREQ (selects the center frequency):

The adjustment range is from 20 Hz to 20 kHz.

Q (sets the Q curve):

Sets one of 1, 3, 5, 7, or 20 as the sharpness of the Q curve.

GAIN (adjusts the output level):

Adjusts the gain (output level) within the range -12dB to +12dB. (1dB steps, 25 points)

- Repeat steps 4 and 5 to adjust the desired item.
- Press the [SOUND] button to return to the original mode.

■ P. EQ adjustment

The settings that can be adjusted in the P.EQ menu are as follows. The center frequency, gain and Q curve can be stored to channel/band combinations.

For example, center frequency “**250Hz**”, gain “**-8dB**” and Q curve “**3**” can be stored to band 1 on the front.

For details on the P.EQ function, see “**P. EQ adjustment**” (cf. page 21).

Changing settings

When a 5.1ch surround decoder is connected, settings relating to music in the adjust mode are changed.







Selecting setting items

The following describes the items whose settings are changed.

For details of other items that are not changed, see “**Changing settings**” (cf. page 34) at “**Operations Common to Each Mode**”.

- Press the [A] button.
The mode changes to the adjust mode.



- Touch  on the setting item display to select the item to set.
 - * Touching  on the left of the display switches main items 1 item at a time. Touching  on the left of the display switches sub-items continuously.
 - * Touching  on the center of the display switches the sub-items 1 item at a time. Touching  switches sub-items continuously.
- When “**THROUGH**” is displayed at the right of the display, touch THROUGH to switch to the adjustment details display.
- Either touch  on the right of the display, or turn the [ROTARY] knob to set the details.

■ To return to the original mode

- Press the [A] button again.



● Setting items

Main Item	Sub-item
SOUND	CENTER-SP / SRD-SP / SUB-WOOFER • Setting the speaker ON/OFF (cf. page 54)
	FRONT HPF / CENTER HPF / SRD HPF / SUB-W LPF • Adjusting the speaker filter frequency (cf. Page 54)
	SP GAIN • Adjusting the speaker output level (cf. page 41)
DELAY	CENTER-SP / SRD-SP • Adjusting the speaker delay time (cf. page 55)
DOLBY D	D-RANGE • Adjusting the dynamic range (cf. page 55)
PL II CONT	PANORAMA / DIMENSION / CTR WIDTH • Setting the music mode in detail (cf. page 42)



Setting speakers ON/OFF (CENTER-SP/SRD-SP/SUB-WOOFER)

Set the center speaker (CENTER-SP), surround speaker (SRD-SP) and sub-woofer (SUB-WOOFER) ON/OFF.

Be sure to set this setting to "OFF" when there is no center speaker, surround speaker or sub-woofer.

- The factory default setting is "ON".
1. Press the [A] button to set to the adjust mode.
 2. Touch    on the setting item display to select "CENTER-SP" under "SOUND", "SRD-SP" under "SOUND", and "SUB-WOOFER" under "SOUND".



3. Either touch    on the right of the display, or turn the [ROTARY] knob to select "ON" or "OFF".
 - * In the case of "SUB-WOOFER", select one of "ON+", "ON-" or "OFF". Normally, select "ON+". However, when "ON-" is set, an effect in the low range can be strongly felt.
4. Press the [A] button to return to the original mode.

Adjusting the filter frequencies of speakers (FRONT HPF/CENTER HPF/SRD HPF/SUB-W LPF)

This function allows you to adjust the filter frequency matched to the speakers you are using.

- A speaker that was turned off in the section "Setting speakers on or off (CENTER-SP/SRD-SP/SUB-WOOFER)" is not displayed.
- The factory default setting for "FRONT HPF" or "SRD HPF" is "THROUGH" (no filter), and for "CENTER HPF" or "SUB-W LPF" is "120Hz".

■ Filter adjustment

FRONT HPF/CENTER HPF/SRD HPF (high-pass filter adjustment)

This filter cuts bass sound from the front center and surround speakers.

THROUGH → 50Hz → 80Hz → 120Hz

Set the filter matched to the speaker when small-diameter speakers are used.

THROUGH

Set this when using speakers that can generate bass. THROUGH cannot be set at CENTER HPF.

SUB-W LPF (sub-woofer low-pass filter adjustment)

This filter cuts treble sound from the sub-woofer.

50Hz → 80Hz → 120Hz

Set the filter frequency to match the sub-woofer.

1. Press the [A] button to set to the adjust mode.

- Touch  on the setting item display to select "FRONT HPF" under "SOUND", "CENTER HPF" under "SOUND", "SRD HPF" under "SOUND", and "SUB-W LPF" under "SOUND".



- Either touch  on the right of the display, or turn the [ROTARY] knob to set the frequency.
 - * Select one of THROUGH*1, 50Hz, 80Hz, and 120Hz.
 - *1 THROUGH is displayed only when "FRONT HPF" or "SRD HPF" is selected.
- Press the [A] button to return to the original mode.

Adjusting the delay time of the speaker (CENTER-SP/SRD-SP)

The timing when the sound of each speaker reaches the listening position depends on your speaker installation and the size of your car. Adjust the delay time of each speaker so that the sound of all speakers reaches the listening position at the same time as the sound from the front speakers.

- The factory default setting is "0 ms".
- Press the [A] button to set to the adjust mode.
 - Touch  on the setting item display to select "CENTER-SP" under "DELAY" and "SRD-SP" under "DELAY".



- Touch  on the right of the display to adjust the delay time.
 - * "CENTER-SP" can be adjusted within the range 0 ms to 5 ms.
 - * "SRD-SP" can be adjusted within the range 0 ms to 15 ms.
- Press the [A] button to return to the original mode.

Adjusting the Dolby Digital functions (D-RANGE)

This function compresses the dynamic range of Dolby Digital to maintain low level sounds such as actor conversation and suppress loud sound volumes.

These functions are only available on Dolby Digital DVD discs.

- The factory default setting is "MAX".
- Press the [A] button to set to the adjust mode.
 - Touch  on the setting item display to select "DOLBY D" under "D-RANGE".



- Touch  on the right of the display to adjust the dynamic range and adjust the desired item.
 - MAX:** maximum dynamic range mode of the original source
 - STD:** recommended mode for standard listening
 - MIN:** the most compressed dynamic range mode that renders even low sounds easy to hear.
- Press the [A] button to return to the original mode.

9. IN CASE OF DIFFICULTY

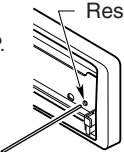
	Problem	Cause	Measure
General	Power does not turn on. (No sound is produced.)	Fuse is blown.	Replace with a fuse of the same amperage. If the fuse blows again, consult your store of purchase.
		Incorrect wiring.	Consult your store of purchase.
	No sound output when operating the unit with amplifiers or power antenna attached.	Power antenna lead is shorted to ground or excessive current is required for remote-on the amplifiers or power antenna.	<ol style="list-style-type: none"> 1. Turn the unit off. 2. Remove all wires attached to the power antenna lead. Check each wire for a possible short to ground using an ohm meter. 3. Turn the unit back on. 4. Reconnect each amplifier remote wire to the power antenna lead one by one. If the amplifiers turn off before all wires are attached, use an external relay to provide remote-on voltage (excessive current required).
	Nothing happens when buttons are pressed. Display is not accurate.	The microprocessor has malfunctioned due to noise, etc.	Turn off the power, then press the [RELEASE] button and remove the DCP. Press the reset button with a thin rod.
	DCP or main unit connectors are dirty.	Wipe the dirt off with a soft cloth moistened with cleaning alcohol.	
CD/MP3/WMA	No sound heard.	There is a disc other than a compact disc or foreign matter already in place.	With the slooping console open, press and hold the [▲] button for 3 seconds or longer. The foreign matter is forcibly ejected.
		MP3/WMA files are absent in a disc.	Write MP3/WMA files onto the disc properly.
		Files are not recognized as an MP3/WMA file.	Use MP3/WMA files encoded properly.
		File system is not correct.	Use ISO9660 level 1, 2 or JOLIET or Romeo file system.
	Sound skips or is noisy.	Disc is dirty.	Clean the disc with a soft cloth.
		Disc is heavily scratched or warped.	Replace with a disc with no scratches.
Sound is cut or skipped. Noise is generated or noise is mixed with sound.	MP3/WMA files are not encoded properly.	Use MP3/WMA files encoded properly.	

	Problem	Cause	Measure
CD/MP3/WMA	Sound is bad directly after power is turned on.	Water droplets may form on the internal lens when the car is parked in a humid place.	Let dry for about 1 hour with the power on.
	Wrong filename	File system is not correct.	Use ISO9660 level 1, 2 or JOLIET or Romeo file system.
	Play list play is not performed.	File name or extension is not correct.	Use alphanumeric/ASCII characters for MP3/WMA file name. Use “.M3U” for the file extension of a play list.

10. ERROR DISPLAYS

If an error occurs, one of the following displays is displayed. Take the measures described below to eliminate the problem.

	Error Display	Cause	Measure
CD/MP3/WMA	ERROR 2	A DISC is caught inside the CD deck and is not ejected.	This is a failure of CD deck's mechanism and consult your store of purchase.
	ERROR 3	A DISC cannot be played due to scratches, etc.	Replace with a non-scratched, non-warped-disc.
	ERROR 6	A DISC is loaded upside-down inside the CD deck and does not play.	Eject the disc then reload it properly.
General	AMP GUARD	The speaker protection circuit is operating. During this operation, if any volume operation is performed, the display shows "AMP GUARD". "AMP GUARD" sometimes functions when special test signals are used.	<ol style="list-style-type: none"> 1. Turn down sound volume. Function can also be restored by turning the power off and on again. (Speaker volume is reduced automatically when the speaker protection circuit operates). 2. If the sound is muted again, consult our service department.
CD changer	ERROR 2	A DISC inside the CD changer is not loaded.	This is a failure of CD changer's mechanism and consult your store of purchase.
	ERROR 3	A DISC inside the CD changer cannot be played due to scratches, etc.	Replace with a non-scratched, non-warped disc.
	ERROR 6	A DISC inside the CD changer cannot be played because it is loaded upside-down.	Eject the disc then reload it properly.
DVD changer	ERROR 2	A DISC inside the DVD changer cannot be played.	This is a failure of DVD mechanism and consult your store of purchase.
	ERROR 3	A DISC cannot be played due to scratches, etc.	Retry or replace with a non-scratched, non-warped-disc.
	ERROR 6	A DISC inside the DVD changer cannot be played because it is loaded upside-down.	Eject the disc then reload it properly
	ERROR P	Parental level error	Set the correct Parental level.
	ERROR R	Region code error	Eject the disc and replace correct region code disc.

If an error display other than the ones described above appears, press the reset button. If the problem persists, turn off the power and consult your store of purchase.

11. SPECIFICATIONS

FM Tuner

Frequency Range:
87.0 MHz to 108.0 MHz

Usable Sensitivity:
9 dBf

50dB Quieting Sensitivity:
15 dBf

Alternate Channel Selectivity:
70 dB

Stereo Separation (1 kHz):
35 dB

Frequency Response (± 3 dB):
30 Hz to 15 kHz

AM Tuner

Frequency Range:
531 kHz to 1629 kHz

Usable Sensitivity:
25 μ V

CD Player

System:
Compact disc digital audio system

Usable Discs:
Compact disc

Frequency Response (± 1 dB):
5 Hz to 20 kHz

Signal to Noise Ratio (1 kHz):
100 dB

Dynamic Range (1 kHz):
96 dB

Harmonic Distortion:
0.01%

Audio

Maximum Power Output:
212 W (53 W \times 4 ch)

Continuous Average Power Output:
18 W \times 4, into 4 Ω , 20 Hz to 20 kHz, 1%THD

Bass Control Action (50 Hz):
 ± 12 dB

Treble Control Action (12.5 kHz):
 ± 12 dB

Line Output Level (CD 1 kHz):
4 V/F 2ch + 4V/R 2ch
4 V/SUB WOOFER 2ch
0.5 V/2-ZONE 2ch

General

Power Supply Voltage:
14.4 V DC (10.8 to 15.6 V allowable), negative ground

Current Consumption:
Less than 15 A, 3A

Speaker Impedance:
4 Ω (4 Ω to 8 Ω allowable)

Weight / Source unit:
1.7 kg (3.74 lb.)

Weight / Remote control unit:
80 g (2.82 oz.) (including battery)

Dimensions / Source unit:
178 (Width) \times 50 (Height) \times 155 (Depth) mm
[7" (Width) \times 2" (Height) \times 6-1/8" (Depth)]

Dimensions / Remote control unit:
44 (Width) \times 110 (Height) \times 27 (Depth) mm
[1-3/4" (Width) \times 4-5/16" (Height) \times 1-1/8" (Depth)]

Note:

- Specifications and design are subject to change without notice for further improvement.

Free Manuals Download Website

<http://myh66.com>

<http://usermanuals.us>

<http://www.somanuals.com>

<http://www.4manuals.cc>

<http://www.manual-lib.com>

<http://www.404manual.com>

<http://www.luxmanual.com>

<http://aubethermostatmanual.com>

Golf course search by state

<http://golfingnear.com>

Email search by domain

<http://emailbydomain.com>

Auto manuals search

<http://auto.somanuals.com>

TV manuals search

<http://tv.somanuals.com>