

Clarion

Owner's manual & Installation manual
Mode d'emploi et manuel d'installation
Bedienungs- & Installationsanleitung
Manuale d'Istruzioni e d'Installazione
Gebruiksaanwijzing en installatie-aanwijzingen
Manual de instrucciones y de instalación
Bruksanvisning- och installations
Manual do proprietário e manual de instalação

VRX633R

**6.5" MONITOR & RDS-EON FM/MW/LW RADIO WITH CD/
MD/DVD CHANGER CONTROL**

**MONITEUR DE 6,5 POUÇES ET RADIO FM/PO/GO RDS-
EON AVEC COMMANDE DE CHANGEUR
DE CD/MD/DVD**

**6,5-ZOLL-MONITOR & RDS-EON UKW/MW/LW-RADIO
MIT CD/MD/DVD-WECHSLERSTEUERUNG**

**MONITOR DA 6,5" E RADIO FM/MW/LW CON COMANDO
CAMBIA CD/MD/DVD**

**6,5" MONITOR EN RDS-EON FM/MW/LW RADIO MET
AANSTURING VOOR CD/MD/DVD-WISSELAAR**

**MONITOR DE 6,5-PULGADAS Y RADIO FM/MW/LW RDS-
EON CON MANDO PARA EL CAMBIADOR DE
CD/MD/DVD**

**6,5-TUMS BILDSKÄRM MED RDS-EON FM/MV/LV-
RADIO OCH CD/MD/DVD-VÄXLARSTYRNING**

**MONITOR DE 6,5 POLEGADAS E AUTO-RÁDIO RDS-EON
FM/MW/LW COM CONTROLO DO PERMUTADOR DE CD/
MD/DVD**

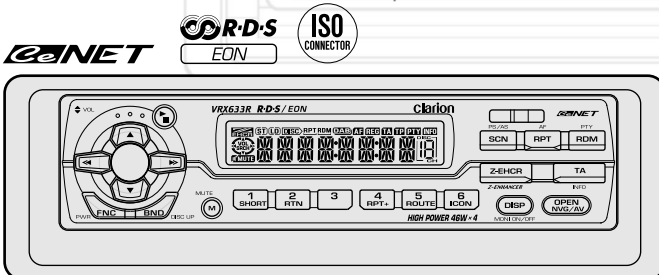

Thank you for purchasing the Clarion VRX633R.

- * This owner's manual is for the VRX633R.
- * Please read this owner's manual in its entirety before operating this equipment.
- * After reading this manual, be sure to keep it in a handy place (e.g., glove compartment).
- * Check the contents of the enclosed warranty card and keep it carefully with this manual.
- * This manual includes the operating procedures of the CD changer, MD changer, DVD changer, TV tuner connected via the CeNET cable. The CD changer, MD changer, DVD changer, TV tuner have their own manuals, but no explanations for operating them are described.

Contents

1. PRECAUTIONS	4	7. DCP	14
2. CAUTIONS ON HANDLING	4	8. OPERATIONS	15
LCD panel/Generalities	4	Basic Operations	15
Cleaning	4	Radio Operations	18
3. CONTROLS	5	RDS Operations	20
4. NOMENCLATURE	6	CD Changer Operations	23
Names of Buttons	6	MD Changer Operations	25
JOYSTICK Operation	7	DVD Changer Operation	27
5. MODE DISPLAY	8	TV Operations	31
Display common to each mode	8	Digital Radio/DAB Operations	34
TITLE LIST mode display	8	NAVI Operations	38
RADIO mode display	9	CCD Camera	39
RDS mode display	9	Connecting other company's image equipment	40
CD/MD Changer mode display	10	Other Functions	40
TV mode display	10	9. IN CASE OF DIFFICULTY	43
DAB mode display	11	10. ERROR DISPLAYS	45
6. REMOTE CONTROL	12	11. SPECIFICATIONS	46
Inserting the Batteries	12		
Functions of Remote Control Unit Buttons	13		

5. MODE DISPLAY

The Color LCD Display and the Information Panel on the main unit show the following displays, providing information about the mode and functions operated.

Display common to each mode

COLOR LCD DISPLAY

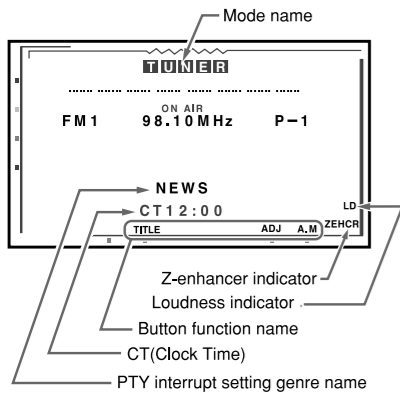

INFORMATION PANEL

MAIN

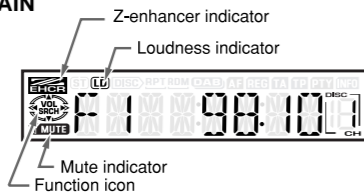

Clock Time display

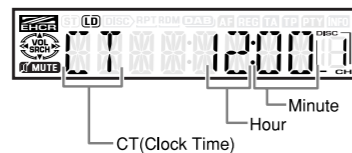

TITLE LIST mode display

COLOR LCD DISPLAY

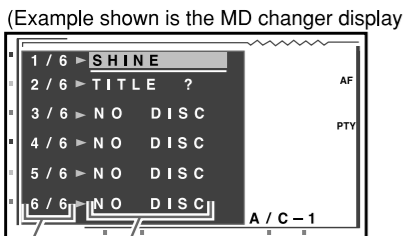

- When the title is not set "TITLE ?" is displayed
- When no disc is set in the changer "NO DISC" is displayed

1. PRECAUTIONS

⚠ WARNING

For your safety, the driver should not watch the TV or operate the controls while driving. Please note that watching and operating the TV while driving are prohibited by law in some countries. Also, while driving, keep the volume to a level at which external sounds can be heard.

- When the inside of the car is very cold and the player is used soon after switching on the heater, moisture may form on the disc (CD/MD/DVD) or the optical parts of the player and proper playback may not be possible. If moisture forms on the disc (CD/MD/DVD), wipe it off with a soft cloth. If moisture forms on the optical parts of the player, do not use the player for about one hour. The condensation will disappear naturally allowing normal operation.
 - Driving on extremely bumpy roads which cause severe vibration may cause the sound to skip.
 - This unit uses a precision mechanism. Even in the event that trouble arises, never open the case, disassemble the unit, or lubricate the rotating parts.
 - TV broadcast reception
 - When receiving the TV broadcasts, the strength of the signals changes since the car is moving, so in some cases it may not be possible to receive clear pictures.
 - TV signals are strongly linear, so reception is affected by buildings, mountains and other obstacles.
 - Such external factors such as electric train lines, a high voltage lines, and signal devices may disturb the picture or cause noise.
 - * If the reception is poor, switch to a station with good reception.
- INFORMATION FOR USERS:**
CHANGES OR MODIFICATIONS TO THIS PRODUCT NOT APPROVED BY THE MANUFACTURER WILL VOID THE WARRANTY.

On navigation

- If the NAVI mode is turned to NVG, the FUNC button becomes invalid and the audio modes cannot be switched.

2. CAUTIONS ON HANDLING

LCD panel/Generalities

For a longer service life, be sure to read the following cautions.

- Be sure to store the LCD panel inside the main unit when parking the car outdoors for long period of time. The LCD panel will operate properly in a temperature range of 0 to 60°C.
- Don't allow any liquids on the set from drinks, umbrellas etc. Doing so may damage the internal circuitry.
- Do not disassemble or modify the set in any way. Doing so may result in damage.
- Do not draw the LCD panel out and use it as a tray. Also, subjecting the LCD panel to shocks may result in breakage, deformation or other damage.
- Do not let cigarettes burn the display. Doing so may damage or deform the cabinet.
- If a problem should occur, have the set inspected at your store of purchase.
- Do not insert objects or poke in the space between the LCD panel and the main unit when the panel is tilted.
- Do not place anything on the display when the panel is tilted.
- The remote controller may not work if the remote control sensor is exposed to direct sunlight.
- In extremely cold weather, the display movement may slow down and the display may darken, but this is not a malfunction. The display will work normally when the temperature increases.
- Small black and shiny spots inside the LCD panel are normal for LCD products.
- The LCD panel may stop temporarily when it opens or closes, when the engine stops or when it is cold.

Cleaning

Cleaning the cabinet

Use a soft, dry cloth and gently wipe off the dirt. For tough dirt, apply some neutral detergent diluted in water to a soft cloth, wipe off the dirt gently, then wipe again with a dry cloth.

Do not use benzene, thinner, car cleaner, etc., as these substances may damage the cabinet or cause the paint to peel. Also, leaving rubber or plastic products in contact with the cabinet for long periods of time may cause stains.

Cleaning the LCD panel

The LCD panel tends to collect dust, so wipe it off occasionally with a soft cloth. The surface is easily scratched, so do not rub it with hard objects.

Be sure to unfold and read the next page. / Veuillez déplier et vous référer à la page suivante.
Bitte ausbreiten und die nächste Seite lesen. / Assicurarasi di aprire e leggere la pagina successiva.
Volgende pagina uitvouwen en doorlezen a.u.b. / Cerciórese de desplegar y de leer la página siguiente.
Glöm inte att vika ut och läsa nästa sida. / Não deixe de abrir e ler a próxima página.

3. CONTROLS / COMMANDES / REGLER / CONTROLLI REGELAARS / CONTROLES / KONTROLLER

Main unit / Unité principale / Hauptgerät / Unità principale
Hoofdtoestel / Unidad principal / Huvudenhët / Unidade principal

With the Display closed / Avec l'afficheur fermé / Mit geschlossenem Display /
Con display chiuso / Met het display gesloten / Con el visualizador cerrado /
Med bildskärmen stängd / Com o écran fechado

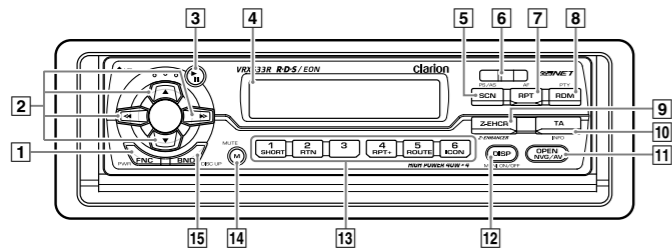

With the Display open / Avec l'afficheur ouvert / Mit geöffnetem Display /
Con display aperto / Met het display geopend / Con el visualizador abierto
Med bildskärmen öppen / Com o écran aberto

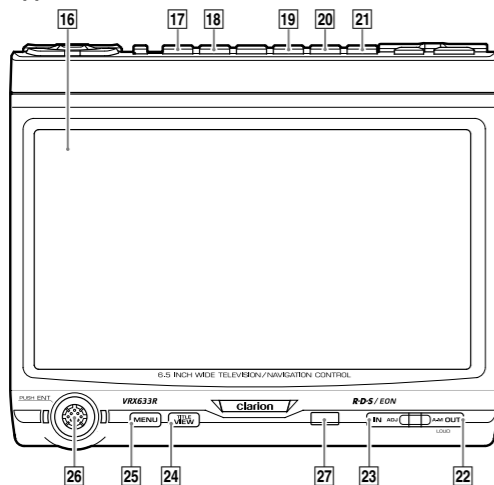

Note: Be sure to unfold this page and refer to the front diagrams as you read each chapter.

Remarque: Veuillez déplier cette page et vous référer aux schémas quand vous lisez chaque chapitre.

Hinweis: Bitte diese Seite ausfalten und beim Lesen der einzelnen Kapitel die Frontdiagramme beachten.

Nota: Assicurarsi di aprire questa pagina e fare riferimento a questi diagrammi quando si legge ciascun capitolo.

Opmerking: Vouw deze pagina uit en zie tevens de afbeeldingen van het voorpaneel tijdens het doorlezen van de volgende hoofdstukken.

Nota: Cuando lea los capítulos, despliegue esta página y consulte los diagramas.

Observera: Vik ut denna sida för att kunna se figurerna över bilstereons framsida medan du läser de olika kapitlen.

Nota: Lembre-se de abrir esta página e consultar os diagramas frontais durante a leitura de cada capítulo.

4. NOMENCLATURE

Names of Buttons

Note:

• Be sure to read this chapter referring to the front diagrams of chapter "2. CONTROLS" on page 5 (unfold).

With the display closed

- 1 POWER button
- 2 FNC (Function) button
- 3 SEARCH button
- 4 VOLUME button
- 5 << button
- 6 >> button
- 7 PLAY/PAUSE button
- 8 Information Panel
- 9 PS (Preset scan)/AS (Auto store) button
- 10 SCN (Scan) button
- 11 DCP RELEASE lever
- 12 AF (Alternative Frequencies) button
- 13 RPT (Repeat) button
- 14 PTY (Program Type) button
- 15 RDM (Random) button
- 16 Z-EHCR (Z-enhancer) button
- 17 INFO (Information) button
- 18 TA (Traffic announcement) button
- 19 OPEN button
- 20 NVG/AV button
- 21 DISP (Display) button
- 22 PRESET buttons (1 to 6)
- 23 DIRECT buttons (1 to 6)
- 24 MUTE button
- 25 BND (Band) button

With the display open

- 16 Color LCD display
- 17 SHORT (Short Cut) button
- 18 RTN (Return) button
- 19 RPT (Repeat) / RPT+ button
- 20 ROUTE button
- 21 ICON button
- 22 A-M (Audio-Mode) button
- 23 OUT (Zoom out) button
- 24 ADJ (Adjust) button
- 25 IN (Zoom in) button
- 26 TITLE button
- 27 VIEW button
- 28 MENU button
- 29 JOYSTICK
- 30 Remote Control Infrared Sensor

JOYSTICK Operation

Note:

- Many settings/procedures have to be performed by using the JOYSTICK [26]. Be sure to read this chapter in order to operate it properly.
- In the DVD changer mode, items for menu display, etc. can be selected by operating the JOYSTICK [26] upward, downward, leftward or rightward.

• Selecting an item in the menu

Select an item displayed in the menu by operating the JOYSTICK [26] upward or downward.

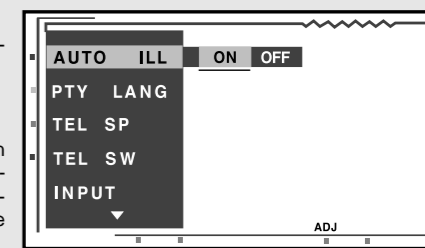

• Setting an option for the selected item

When the setting options for an item are listed on the right of the display, you can choose the desired option by operating the JOYSTICK [26] leftward or rightward. Then, press the center of the JOYSTICK [26] to set your choice.

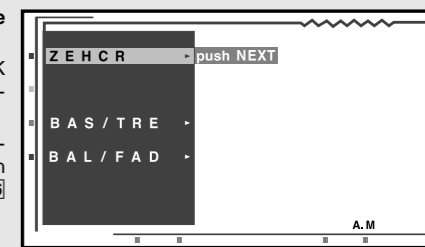

• When "push NEXT" is displayed next to the menu item

1. Press the ENT at the center of the JOYSTICK [26] to select the item and show the setting display for this item.
2. Operate the JOYSTICK [26] upward or downward to select the desired setting option, then press ENT at the center of the JOYSTICK [26] to set your choice.

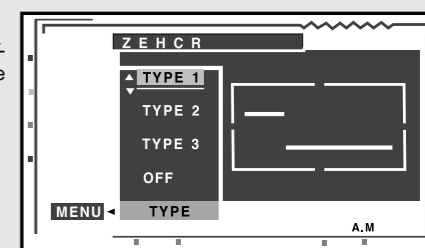

• Returning to the previous mode

Select the "MENU" by operating the JOYSTICK [26] leftward or rightward, then press the ENT at the center of the JOYSTICK [26].

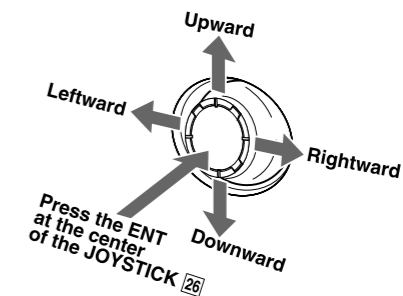

RADIO mode display

COLOR LCD DISPLAY

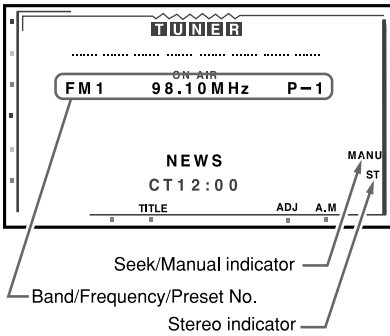

INFORMATION PANEL

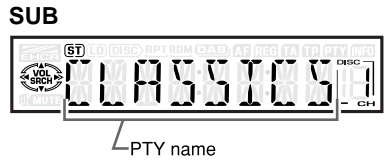
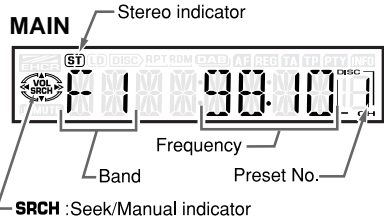

RDS mode display

COLOR LCD DISPLAY

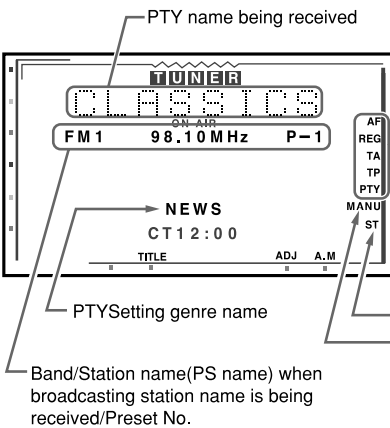

INFORMATION PANEL

- AF** :AF(Alternative frequency) indicator
- REG** :REG(Regional programme) indicator
- TA** :TA(Traffic announcement) indicator
- TP** :TP(Traffic programme) indicator
- PTY** :PTY(Programme type) indicator

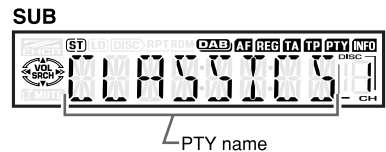
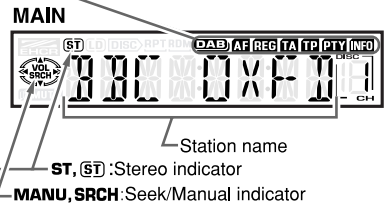

CD/MD Changer mode display

COLOR LCD DISPLAY

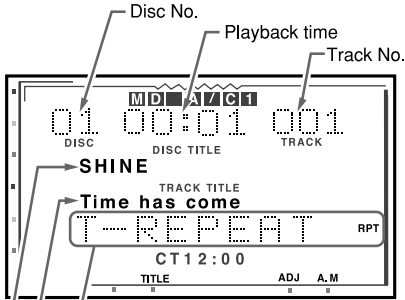

- When the play mode is selected, the display shows as follows:
- T-SCAN : Scan play
 - T-REPEAT, RPT : Repeat play
 - T-RANDOM, RDM : Random play
 - D-SCAN : Disk scan play
 - D-REPEAT, D-RPT : Disk repeat play
 - D-RANDOM, D-RDM : Disk random play

Track title
Disc title

INFORMATION PANEL

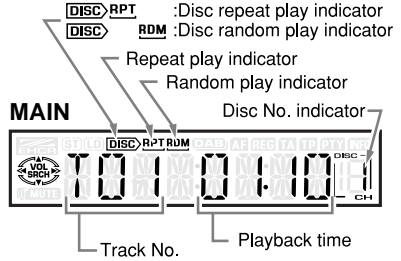

SUB

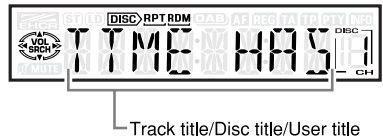

TV mode display

COLOR LCD DISPLAY

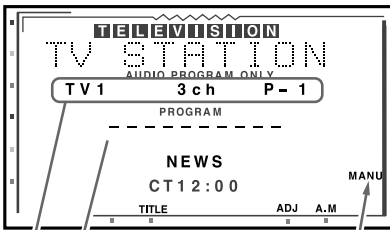

User title
Band/Channel/Preset No.

INFORMATION PANEL

MAIN

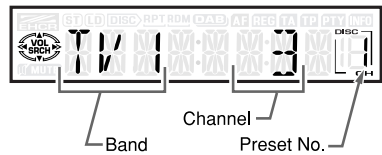

SUB

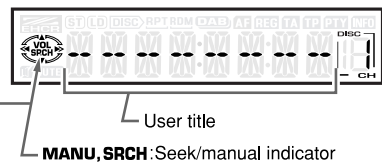

DAB mode display

COLOR LCD DISPLAY

INFORMATION PANEL

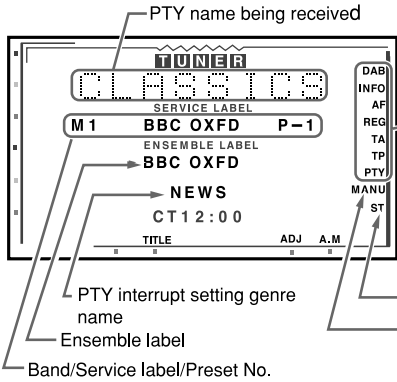

- DAB, DAB**: DAB indicator
- INFO, INFO**: INFO (Information) indicator
- AF, AF**: AF (Alternative frequency) indicator
- REG, REG**: REG (Regional programme) indicator
- TA, TA**: TA (Traffic announcement) indicator
- TP, TP**: TP (Traffic programme) indicator
- PTY, PTY**: PTY (Programme type) indicator

PTY name being received

Band/Service label/Preset No.

Ensemble label

PTY interrupt setting genre name

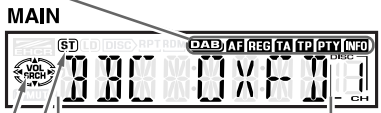

MAIN

Station name

ST, ST: Stereo indicator

MANU, SRCH: Seek/manual indicator



SUB

PTY name

DVD Changer mode display

COLOR LCD DISPLAY

INFORMATION PANEL

While the car is moving, the screen below is displayed.

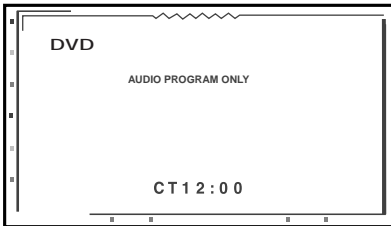

MAIN



- No sub-indication

6. REMOTE CONTROL

When the panel is open

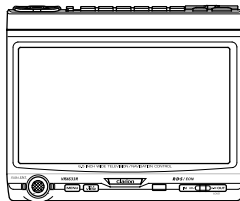

Remote control unit

Operating range: 30° in all directions

Signal transmitter

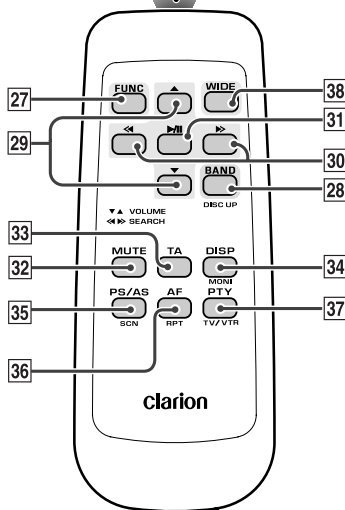

Inserting the Batteries

1. Turn the remote control unit over, then slide the rear cover in the direction of the arrow.
2. Insert the AA (SUM-3, IECR-6/1.5V) batteries that came with the remote control unit facing in the directions shown in the figure, then close the rear cover.

Notes:

Using batteries improperly can cause them to explode. Take note of the following points:

- When replacing batteries, replace both batteries with new ones.
- Do not short-circuit, disassemble or heat batteries.
- Do not dispose of batteries into fire or flames.
- Dispose of spent batteries properly.

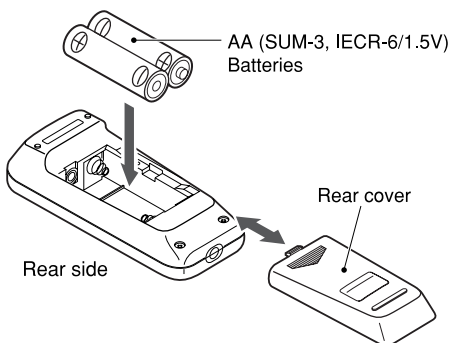

Functions of Remote Control Unit Buttons

Mode Button	Radio (RDS)	CD changer MD changer DVD changer	TV
[27] FUNC	Switches among Radio, DAB, CD changer, MD changer, DVD changer and TV.		
[28] BAND DISC UP TOP	Switches reception band.	Moves to the next disc in increasing order.	Switches reception band.
[29] VOLUME	Increases and decreases volume (in all modes).		
[30] SEARCH	Moves preset channels up and down.	Moves tracks up and down. When pressed and held for 1 second: Fast-forward/Fast-backward.	Moves preset channels up and down.
[31] PLAY/ PAUSE	No function.	Switches between playback and pause.	No function.
[32] MUTE	Turns mute on and off.		
[33] TA	TA on and off.		
[34] DISP MONI	Turns on and off the monitor.	Turns on and off the monitor. DVD changer mode; When pressed and held for 1 second: Superimpose (Playback information is displayed.) When pressed and held with Superimpose on: Switches the screen sizes.	Turns on and off the monitor. When pressed and held for 1 second: Superimpose (Playback information is displayed.) When pressed and held with Superimpose on: Switches the screen sizes.
[35] PS/AS SCN	Preset scan. When pressed and held for 2 seconds: Auto store.	Scan play. When pressed and held for 1 second: Disc scan play. (*)	Preset scan. When pressed and held for 2 seconds: Auto store.
[36] AF RPT	AF function on and off. When pressed and held for 1 second: REG function on and off	Repeat play. When pressed and held for 1 second: Disc repeat play. (*)	No function.
[37] PTY RDM TV/VTR	PTY standby mode on and off.	Random play. When pressed and held for 1 second: Disc random play. (*)	Switches between TV and VTR.
[38] WIDE	No function.	CD/MD changer: No function. DVD changer mode: Switches the screen sizes.	Switches the TV mode.

Notes:

- The remote control unit does not work when the panel is closed.
- Some of the corresponding buttons on the main unit and remote control unit have different functions.
- In the DVD changer mode, the remote control unit can not work for some items.
- Please use the dedicated remote control in the DVD changer mode.

(*) In the DVD changer mode, this remote control unit makes the same operation as that performed using the button with the same name on the remote control unit for the DVD changer.

7. DCP

The control panel can be detached to prevent theft. When detaching the control panel, store it in the DCP (DETACHABLE CONTROL PANEL) case to prevent scratches.

We recommend taking the DCP with you when leaving the car.

Removing the DCP

1. Turn the power off.
2. Deeply push in the DCP RELEASE lever  to release the DCP/Operation Panel.

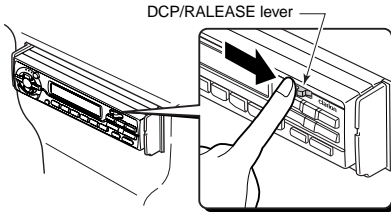

3. Pull the DCP toward you and remove it.

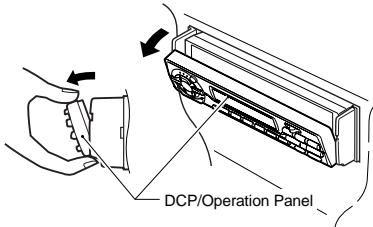

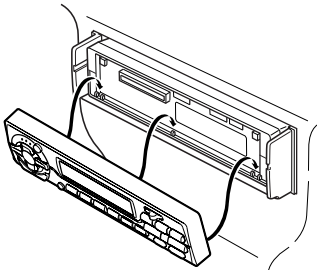

Attaching the DCP

1. Hold the DCP/Operation Panel with its rear side facing the main unit and, as shown in the figure below, put the lower edge of the panel onto the corresponding edge of the main unit.

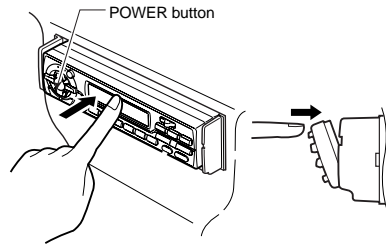

2. Lock the DCP/Operation Panel at the upper center until a click is heard.



3. Press the power button  to turn on the power .

* The unit will not accept any key inputs for 1 second after the DCP has been reattached.

CAUTION

- The DCP can easily be damaged by shocks. After removing it, be careful not to drop it or subject it to strong shocks.
- If the Operation Panel is kept open, the DCP may drop due to vibration of the car. This results in damage to the DCP. So close the Operation Panel or remove the DCP to store into the case.
- The connector connecting the main unit and the DCP is an extremely important part. Be careful not to damage it by pressing on it with fingernails, screwdrivers, etc.

Note:

- If the DCP is dirty, wipe off the dirt with a soft, dry cloth only.

8. OPERATIONS

Basic Operations

Note: Be sure to read this chapter referring to the front diagrams of chapter "3. CONTROLS" on page 5 (unfold).

⚠ CAUTION

When the unit is turned on, starting and stopping the engine with its volume raised to the maximum level may harm your hearings. Be careful about adjusting the volume.

Note:

- Use this unit after starting the engine.



ACC or engine
ON position

Turning on and off the power

Note:

- Be careful about using this unit for a long time without running the engine. If you drain the car's battery too far, you may not be able to start the engine and this can reduce the service life of the battery.

1. Press the POWER button **1**.
2. The illumination and display on the unit light up. The unit automatically remembers its last operation mode and will automatically switch to display that mode.
3. Press and hold the POWER button **1** for 1 second or longer to turn off the power for the unit.

Note:

- About the "SYSTEM CHECK"

The confirmation of connected equipment must be performed for this unit only when the wiring connection is complete and power is turned on to the unit first. When the power is supplied, "SYSTEM" and "PUSH PWR" appear alternately in the display. Press the POWER button **1**, the system check starts inside the unit. When "COMPLETE" appears, press once again the POWER button **1**.

Selecting a mode

1. Press the FNC button **1** to change the mode of operation.
2. Each time you press the FNC button **1**, the mode of operation changes in the following order:

Radio mode → DAB mode → CD changer mode → MD changer mode → DVD changer mode → TV mode → Radio mode...

- * External equipment not connected with CeNET is not selected.

Adjusting the volume

Operate the VOLUME button **2** in the direction of the arrows ▲ (up) or ▼ (down) to adjust the volume;

▲: Increases the volume.

▼: Decreases the volume.

- * The volume level indicated in the display is in a range from 0 (minimum) to 33 (maximum).

⚠ CAUTION

While driving, keep the volume at a level at which external sounds can be heard.

Switching the display

When the panel is closed:

Press the DISP button **12** to select the desired display.

Each time you press the DISP button **12**, the display switches in the following order:

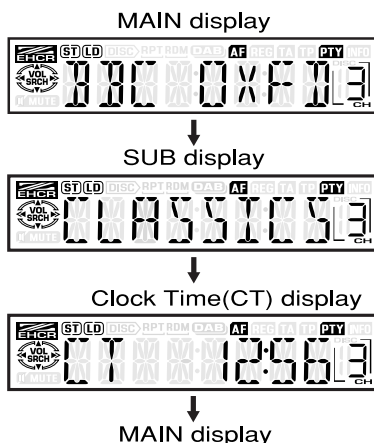

Notes:

- Once selected, the preferred display becomes the default display. When a function adjustment such as volume is made, the display momentarily switches to that function's display, then returns back to the preferred display several seconds after the adjustment.

Basic Operations

- If a title has been input, it is shown in the SUB display. If no title has been input, "-----" appears in the display. To input a title, refer to the subsection "Entering titles" in "Other Functions" section.
- For CD, MD and TV, some special characters of the title, the PS name of the RDS, and the DAB service label will not be displayed on the Information Panel of the DCP. In this case, those characters will only be left blank.
- When CT data is not received, "CT--:--" appears in the display.

Showing a mode display

When the panel is open:

Press the TITLE button [24] to show the Title List display. In the Title List display, the titles of items stored in the PRESET buttons [13] 1 to 6 are listed.

- * In the RDS tuner mode, a PS name is displayed.
- * In the DAB mode, a service label is displayed.
- * For detailed information, refer to the section "Title list play".

Opening and turning the display

Notes:

- Do not place any object on the open display.
 - Do not drop any object on the movable part.
 - Do not expose the display to shocks.
1. Press the OPEN button [11] to open the Color LCD display [16].
 - * If the Color LCD display [16] is left horizontally in the open position for 10 seconds or longer, it is automatically drawn in.
 2. Turn the Color LCD display [16] upwards to a good view angle.

When the monitor is turned upwards, a picture appears in the display. The Information Panel [4] display disappears.

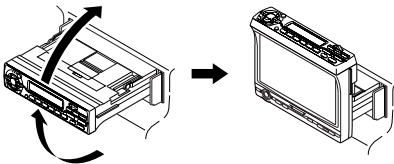

3. To store the Color LCD display [16] in the source unit, turn it to the horizontal position until a click is heard.

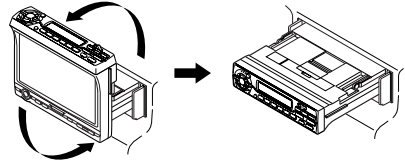

Turning on and off the monitor

Pressing the DISP button [12] turns the monitor on and off.

- * When a button is pressed or during security monitoring, the monitor-off mode is canceled.

Mute

Each time you press the MUTE button [14], mute is turned on and off.

"MUTE" appears when mute is turned on.

Setting the Z-enhancer

This unit comes with 3 types of sound tone effect stored in memory. Select the one you prefer.

- * The factory default setting is "Z-EHCR OFF". When a Z-enhancer comes on (1-3), "Z-EHCR" appears in the display.
- "Z-EHCR 1" (Z-Enhancer 1):
Setting emphasizing bass.
- "Z-EHCR 2" (Z-Enhancer 2):
Setting emphasizing treble.
- "Z-EHCR 3" (Z-Enhancer 3):
Setting emphasizing bass and treble.
- "Z-EHCR OFF" (Z-Enhancer off):
Neither bass nor treble are emphasized by the Z-enhancer.

⚠ CAUTION

Do not turn the display unless it is completely open.

When adjusting the angle of the display be careful no to let your fingers get caught by the panel or instrument panel of the vehicle.

When the panel is closed:

Each time you press the Z-EHCR button [9], the tone effect changes in the following order:

“Z-EHCR 1” → “Z-EHCR 2” → “Z-EHCR 3” → “Z-EHCR OFF” → “Z-EHCR 1”...

When the panel is open:

1. Press the A-M button [22] to change into the AUDIO-MODE display.
2. Operate the JOYSTICK [26] upward or downward to select “Z-EHCR”. Press the ENT at the center of the JOYSTICK [26] to change into the Z-enhancer selecting display.
3. Operate the JOYSTICK [26] upward or downward to select out of:
 “TYPE 1” (Z-Enhancer 1) ↔ “TYPE 2” (Z-Enhancer 2) ↔ “TYPE 3” (Z-Enhancer 3) ↔ “OFF” (Z-Enhancer off),
 and press the ENT at the center of the JOYSTICK [26] to set a desired Z-enhancer.
4. When the setting is finished, operate the JOYSTICK [26] rightward or leftward to move the cursor to the “MENU”. Then press the ENT at the center of the JOYSTICK [26] to return to the AUDIO-MODE display.

* To return from the AUDIO-MODE display to the STANDARD display, press the A-M button [22] once again.

Adjusting the Z-enhancer**Note:**

• This function is enabled only when the panel is open.

1. Press the A-M button [22] to change into the AUDIO-MODE display.
2. Operate the JOYSTICK [26] upward or downward to select “Z-EH LVL” level. Press the ENT at the center of the JOYSTICK [26] to change into the Z-enhancer adjusting display.
3. Operate the JOYSTICK [26] upward or downward to adjust the Z-enhancer level.
 * When Z-Enhancer 1 is selected, you can adjust the bass in the range of ± 2 .
 * When Z-Enhancer 2 is selected, you can adjust the treble in the range of ± 2 .
 * When Z-Enhancer 3 is selected, you can adjust the bass and treble in the range of ± 2 .
4. When the adjustment is finished, operate the JOYSTICK [26] rightward or leftward to move the cursor to “MENU”. Then press the ENT at the center of the JOYSTICK [26] to return to the AUDIO-MODE display.

Adjusting the bass and treble**Notes:**

- This function is enabled only when the panel is open.
- This function can be adjusted only when the Z-enhancer is OFF.

1. Press the A-M button [22] to change into the AUDIO-MODE display.
2. Operate the JOYSTICK [26] upward or downward to select “BAS/TRE”. Then press the ENT at the center of the JOYSTICK [26] to change into the BASS/TREBLE adjusting display.
3. Operate the JOYSTICK [26] rightward or leftward to adjust the “BASS” or “TREBLE”.
4. Operate the JOYSTICK [26] upward or downward to adjust a level (adjustment range: from -6 to 6).
5. When the adjustment is finished, operate the JOYSTICK [26] rightward or leftward to move the cursor to “MENU”. Then press the ENT at the center of the JOYSTICK [26] to return to the AUDIO-MODE display.

Adjusting the balance and fader**Note:**

- This function is enabled only when the panel is open.

1. Press the A-M button [22] to change into the AUDIO-MODE display.
2. Operate the JOYSTICK [26] upward or downward to select “BAL/FAD”. Then press the ENT at the center of the JOYSTICK [26] to change into the BAL/FAD adjusting display.
3. Operate the JOYSTICK [26] rightward or leftward to select “BALANCE” or “FADER”.
4. Operate the JOYSTICK [26] upward or downward to make an adjustment.
 Adjusting range of the balance: L13 to R13
 Adjusting range of the fader: front 12 / rear 12
5. When the adjustment is finished, operate the JOYSTICK [26] rightward or leftward to move the cursor to “MENU”. Then press the ENT at the center of the JOYSTICK [26] to return to the AUDIO-MODE display.

Basic Operations

Turning on/off the loudness

The loudness effect emphasizes the bass and treble to create a natural sound tone. When you are listening to music at a low volume, it is recommended to use the loudness effect.

* This function is enabled only when the panel is open.

1. Press the A-M button **[22]** for 1 second or longer to select Loudness ON. The "LD" indicator lights in the display.
2. Press the A-M button **[22]** for 1 second or longer to select Loudness OFF. The "LD" indicator goes off.

CT (Clock Time) function

The CT function receives CT data sent from an RDS station and displays the time. Press the DISP button **[12]** to switch to CT display.

* If CT is not being received, "CT--:--" appears in the display.

Note:

- CT data is not transmitted in some countries and by some broadcast stations. Also, in some areas, the CT may not be displayed accurately.

Radio Operations

Listening to the radio

1. Press the FNC button **[1]** and select the RADIO mode. The frequency or PS is displayed.
 - * PS: Programme service name
2. Press the BND button **[15]** and select the radio band. Each time the button is pressed, the radio reception band changes in the following order:

FM1 → FM2 → FM3 → AM (MW/LW) → FM1...
3. Press the right or left side of the SEARCH button **[2]** to tune in the desired station.

Tuning

There are 3 types of tuning mode available, seek tuning, manual tuning and preset tuning.

Seek tuning

There are 2 types of seek tuning: DX SEEK and LOCAL SEEK.

DX SEEK can tune in to receivable broadcast stations; LOCAL SEEK can tune in to only broadcast stations with a good reception condition.

1. Press the BND button **[15]** and select the desired band. (FM or AM (MW, LW))
2. Tune in to a station.
 - * If "MANU" is lit in the display (or when the panel is closed, if the indicator "SRCH" is not lit) press and hold the BND button **[15]** for 1 second or longer. "MANU" in the display goes off (or when the panel is open the indicator "SRCH" lights) and seek tuning is now available.
 - * If "TA" is lit in the display, TP stations are automatically sought.

● DX SEEK

Press the right or left side of the SEARCH button **[2]** to automatically seek a station.

When the right side of the SEARCH button **[2]** is pressed, the station is sought in the direction of higher frequencies; when the left side of the SEARCH button **[2]** is pressed, the station is sought in the direction of lower frequencies.

* When seek tuning starts, "DX SEEK" appears in the display.

● LOCAL SEEK

If you press and hold the right or left side of the SEARCH button **[2]** for 1 second, local seek tuning is carried out. Broadcast stations with good reception condition are selected.

* When local seeking starts, "LO SEEK" appears in the display.

Manual tuning

There are 2 ways available: Quick tuning and step tuning.

When you are in the step tuning mode, the frequency changes one step at a time. In quick tuning mode, you can quickly tune the desired frequency.

1. Press the BND button **[15]** and select the desired band. (FM or AM (MW/LW))

* If "MANU" is not lit in the display (or when the panel is closed, if the indicator "SRCH" is lit), press and hold the BND button **[15]** for 1 second or longer. "MANU" appears in the display (or when the panel is closed, the indicator "SRCH" goes off) and manual tuning is now available.

2. Tune into a station.

● Quick tuning:

Press and hold the right or left side of the SEARCH button **[2]** for 1 second or longer to tune in a station.

● Step tuning:

Press the right or left side of the SEARCH button **[2]** to manually tune in a station.

Note:

- Manual tuning is cancelled if you do not operate the unit for 7 seconds or longer.

Recalling a preset station

A total of 24 preset positions (6-FM1, 6-FM2, 6-FM3, 6-AM) exists to store individual radio stations in memory. Pressing the corresponding PRESET button **[13]** recalls the stored radio frequency automatically.

1. Press the BND button **[15]** and select the desired band. (FM or AM (MW/LW))
2. Press the corresponding PRESET button **[13]** to recall the stored station.

* Press and hold one of the PRESET buttons **[13]** for 2 seconds or longer to store that station into preset memory.

Manual memory

1. Press the BND button **[15]** and select the desired band. (FM or AM (MW/LW))
2. Select the desired station with seek tuning, manual tuning, or preset tuning.
3. Press and hold one of the PRESET buttons **[13]** for 2 seconds or longer to store the current station into preset memory.

Auto store

Auto store is a function for storing up to 6 stations that are automatically tuned in sequentially. If 6 receivable stations cannot be received, a previously stored station remains unoverwritten at the memory position.

1. Press the BND button **[15]** and select the desired band. (FM or AM (MW/LW))
2. Press and hold the PS/AS button **[5]** for 2 seconds or longer. The stations with good reception are stored automatically to the preset channels.

* If auto store is performed in the FM bands, the stations are stored in FM3 even if FM1 or FM2 was chosen for storing stations.

Preset scan

Preset scan receives the stations stored in preset memory in order. This function is useful when searching for desired station in memory.

1. Press the PS/AS button **[5]**.
2. When the desired station is tuned in, press the PS/AS button **[5]** again to continue receiving that station.

RDS Operations

RDS (Radio Data System)

This unit has a built in RDS decoder system that supports broadcast stations transmitting RDS data. This system can display the name of the broadcast station being received (PS) and can automatically switch to the broadcast station with the best reception as you move long distances (AF switching). Also, if a traffic announcement or programme type information is broadcast from an RDS station, no matter what mode you are in, this broadcast is received. Additionally, if EON information is received, this information enables automatic renewal of other preset stations on the same network and interruption of traffic announcement and/or chosen program type from other stations (TP). This function is not available in some areas.

When using the RDS function, always set the radio to FM mode.

- **"AF"** : Alternative Frequency
- **"PS"** : Programme Service Name
- **"PTY"** : Programme Type
- **"EON"** : Enhanced Other Network
- **"TP"** : Traffic Programme

* RDS interrupt does not function during AM radio reception or in TV mode.

AF function

The AF function switches to a different frequency on the same network in order to maintain optimum reception.

* The factory default setting is "ON".

● Switching OFF the AF function

Press the AF button [7]. The "AF" indicator goes off.

● Switching ON the AF function

Press the AF button [7]. The "AF" indicator lights.

* If the reception of the current broadcast station deteriorates durably, "SEARCH" lights in the display and the radio searches for the same programme on another frequency.

* When the reception deteriorates, the "AF" indicator flickers.

● AF function between RDS and DAB

When the same programme is broadcast by both RDS and DAB, and this function is ON, the unit switches automatically to the broadcast with the better reception.

* This function only operates when the DAH9500z DAB unit, sold separately, is connected.

1. Press the ADJ button [23] to show the adjustment selection display.
2. Operate the JOYSTICK [26] upward or downward to select "LINKACT".
3. Operate the JOYSTICK [26] rightward or leftward to select "ON" or "OFF". After selection, press the ENT at the center of the JOYSTICK [26].
 - **ON:**
AF switching between DAB and RDS enabled.
 - **OFF:**
AF switching between DAB and RDS disabled.
4. Press the ADJ button [23] to return to the previous mode.

REG (Regional programme) function

When the REG function is ON, the optimum regional station can be received. When this function is OFF, if the regional station area switches as you drive, a regional station for that region is received.

* The factory default setting is "OFF".

Notes:

- This function is disabled when a national station such as BBC 2 FM is being received.
- The REG function ON/OFF setting is valid when the AF function is ON.

● Turning the REG function ON

When "REG" is not lit in the display, press and hold the AF button [7] for 2 seconds or longer. "REG" lights in the display.

● Turning the REG function OFF

Press and hold the AF button [7] for 2 seconds or longer. "REG" in the display goes off.

Manually tuning a regional station in the same network

Note:

• This function can be used when a regional broadcast of the same network is received.

1. This function is valid when the AF function is ON and the REG function is OFF.
2. Press any one of the PRESET buttons [13] to call out a regional station.
3. Each time you press the same PRESET button [13], the unit switches from a local station to the other on the same network.

TA (Traffic Announcement)

In TA standby mode, when a traffic announcement broadcast starts, the traffic announcement broadcast is received as top priority regardless of the function mode so you can listen to it. Traffic programme (TP) automatic tuning is also possible.

- * RDS interrupt does not function during AM radio reception or in TV mode.
- * This function can only be used when "TP" is lit in the display. When "TP" is lit, this means that the RDS broadcast station being received has traffic announcement programmes.

● Setting TA standby mode

If you press the TA button [10] when only "TP" is lit in the display, "TP" and "TA" light in the display and the unit is set into TA standby mode until a traffic announcement is broadcast. When a traffic announcement broadcast starts, "TRA INFO" appears in the display. If you press the TA button [10] while a traffic announcement broadcast is being received, the traffic announcement broadcast reception is cancelled and the unit goes into TA standby mode.

● Cancelling TA standby mode

With "TP" and "TA" are lit in the display, press the TA button [10]. The "TA" in the display goes off and TA standby mode is cancelled.

- * If "TP" is not lit, pressing the TA button [10] searches for a TP station.

● Searching for a TP station

When "TP" is not lit, if you press the TA button [10], "TA" lights in the display and the unit automatically searches a TP station.

Note:

- If a TP station is not received, the unit continues the search operation. Pressing the TA button [10] again makes the "TA" indicator go off and stops TP station searching.

Auto store function for TP stations

You can automatically store up to 6 TP stations into preset memory. If the number of TP that can be received is less than 6, broadcast stations already stored in memory are left without being overwritten.

1. With "TA" lit in the display, press the PS/AS button [5] for 2 seconds or more.
2. The TP stations with the good reception condition are stored into preset memory.
 - * Even if you select FM1 or FM2, a TP station is stored into memory for FM3.

PTY

This function enables you to listen to a broadcast of the selected programme type when it starts, even if the unit operates on a function mode other than radio.

- * RDS interrupt does not function during AM radio reception or in TV mode.
- * Some countries do not yet have PTY broadcast.
- * In TA standby mode, a TP station has priority over a PTY broadcast station.

Selecting PTY

1. When you press the PTY button [8], the unit goes into PTY select mode.
2. Press any one of the PRESET buttons [13] to select a desired PTY. Alternatively, when the panel is closed, operate the SEARCH button [2] upward or downward to select a desired PTY.

- * Below are the factory default settings stored for the PRESET buttons [13].

Preset number	PTY item	
	ENGLISH	Contents
1	NEWS	News
2	INFO	Information
3	POP M	Pop music
4	SPORT	Sports
5	CLASSICS	Classics
6	M,O,R,M	Middle of the road music

3. The PTY select mode is cancelled automatically 7 seconds after a PTY is selected.

● Cancelling PTY standby mode

When you press the PTY button [8] for 1 second or longer, the indicator "PTY" goes off and PTY standby mode is cancelled.

● Cancelling a PTY interrupt broadcast

Press the PTY button [8], during the PTY interrupt broadcast to display the subsidiary, the PTY interrupt is cancelled and the unit returns to PTY standby mode.

PTY seek

1. Press the PTY button [8], the PTY select mode is turned on.
2. Select a desired PTY.
3. Press the right or left side of the SEARCH button [2]. If you press the right side, the unit seeks a PTY broadcast moving up the frequencies; if you press the left side, it seeks moving down the frequencies.

* If no station with the selected PTY broadcast can be received, the unit returns to the MAIN mode.

PTY preset memory

1. When you press the PTY button [8], the PTY select mode is turned on.
2. Select a desired PTY.
3. If you press and hold any one of the PRESET buttons [13] for 2 seconds or longer, the selected PTY is stored into that preset channel memory.

The 29 types of PTY below can be selected.

PTY item	
ENGLISH	Contents
NEWS	News
AFFAIRS	Today's events
INFO	Information
SPORT	Sports
EDUCATE	Education
DRAMA	Drama
CULTURE	Culture
SCIENCE	Science
VARIED	Variety
POP M	Pop music
ROCK M	Rock music
M,O,R, M	Middle of the road music
LIGHT M	Light music
CLASSICS	Classics
OTHER M	Other music
WEATHER	Weather
FINANCE	Finance
CHILDREN	For children
SOCIAL A	Social affairs
RELIGION	Religion
PHONE IN	Phone in
TRAVEL	Travel
HOBBIES	Hobbies
JAZZ	Jazz
COUNTRY	Country
NATIONAL	National
OLDIES	Oldies
FOLK M	Folk music
DOCUMENT	Documentaries

Operating the PTY SELECT display when the panel is open

1. Press the PTY button [8] to select the PTY SELECT display.
2. In the PTY SELECT display, PTY is selected and PTY memory can be adjusted.
Operate the JOYSTICK [26] rightward or leftward to select "PTY ITEM" or "PRESET" (by moving the cursor).
3. When "PTY ITEM" is selected, PTY selection is carried out. Operate the JOYSTICK [26] upward or downward to select a desired PTY. Press the ENT at the center of the JOYSTICK [26] to set the selected PTY ITEM.
(The PTY ITEM thus set is listed at the lower right of the display).
4. When "PRESET" is selected, PTY preset memory can be called for and stored.
5. Operate the JOYSTICK [26] upward or downward to select Preset Nos. 1 to 6.
6. Press the ENT at the center of the JOYSTICK [26] to call for the preset PTY ITEM.
Press the ENT at the center of the JOYSTICK [26] for 2 seconds to store the PTY ITEM currently selected to any Preset No. selected (listed at the lower right of the display).
7. After adjustment is finished, operate the JOYSTICK [26] rightward or leftward to move the cursor to "MENU", and press the ENT at the center of the JOYSTICK [26] to return to the STANDARD display.

Emergency broadcast

If an emergency broadcast is received, all the function mode operations are stopped. "ALARM" appears in the display and the emergency broadcast can be heard.

* RDS interrupt does not function during AM radio reception or in TV mode.

● Cancelling an emergency broadcast

If you press the AF Button [7], emergency broadcast reception is cancelled.

Switching the PTY display language

Note:

- This function is enabled only when the panel is open.

You can select one of 4 languages (English, German, Swedish or French) for the PTY displayed in the display.

* The factory default setting is "GB" (English).

1. Press the ADJ button [23] to show the adjustment selection display.
2. Operate the JOYSTICK [26] upward or downward to select "PTY LANG". After that, select a desired language by operating the JOYSTICK [26] rightward or leftward and then press the ENT at the center of the JOYSTICK [26] to change the setting.

"GB": English

"F": French

"D": German

"S": Swedish

3. Press the ADJ button [23]. The unit returns to the previous mode.

Volume setting of TA, emergency broadcast (ALARM) and PTY

The volume for TA, ALARM and PTY interrupts can be set during TA, ALARM or PTY interrupt.

* The factory default setting is "15".

During a TA, ALARM or PTY interrupt, operate the VOLUME button [2] upward or downward to set the volume to the desired level (00 to 33).

* When the TA, ALARM or PTY interrupt ends, the volume returns to the level it had before the interrupt.

CD changer functions

When an optional CD changer is connected through the CeNET cable, this unit controls all CD changer functions. This unit can control a total of 2 changers (MD and/or CD).

Press the FNC button [1] and select the CD changer mode to start play. If 2 CD changers are connected, press the FNC button [1] to select the CD changer for play.

- * If "NO MAG" appears in the display, insert the magazine into the CD changer. "LOADING" appears in the display while the player loads (checks) the magazine.
- * If "NO DISC" appears in the display, eject the magazine and insert discs into each slot. Then, reinsert the magazine back into the CD changer.

⚠ CAUTION

CD-ROM discs cannot be played in the CD changer.

Pausing play

1. Press the PLAY/PAUSE button [3] to pause play. "PAUSE" appears in the display.
2. To resume play, press the PLAY/PAUSE button [3] again.

Displaying CD titles

This unit can display title data for CD-text CDs and user titles input with this unit.

Each time you press and hold the DISP button [12] for 1 second or longer, the title display changes in the following order.

When the panel is closed:

User title (disc) → CD-text title (disc) → CD-text title (track) → User title (disc)...

When the panel is open:

User title (disc) → CD-text title (disc & track) → User title (disc)...

Note:

- If the CD playing is not a CD-text CD or no user title has been input, "-----" appears in the display.

● Scrolling a CD-text title

When a CD-text title is longer than 16 characters (8 characters when the panel is closed), you can scroll the display as follows.

When the panel is closed:

1. Display the CD-text title (disc or track).
2. Press and hold the BND button [15] for 1 second or longer. The titles scroll.

When the panel is open:

1. Display the CD-text title (disc & track).
2. Press and hold the TITLE button [24] for 1 second or longer to scroll the disc title.
3. To scroll the track title, press for 1 second or longer the TITLE button [24] within 30 seconds after scrolling the disc title.

Notes:

- If the disc title is shorter than 16 characters, the track titles begin to scroll immediately.
- If the track title is shorter than 16 characters, the track titles does not scroll.

Selecting a CD

Each of the DIRECT buttons [13] corresponds to a disc loaded into the magazine.

● Selecting a disc from 1 to 6

Press the corresponding DIRECT button (1 to 6) [13] to select the desired disc.

● Selecting a disc from 7 to 12 (only when a 12 disc CD changer is used.)

Press the corresponding DIRECT button (7 to 12) [13] for 1 second or more, then select the desired disc.

Selecting a track

● Track-up

1. Press the right side of the SEARCH button [2] to move ahead to the beginning of the next track.
2. Each time you press the right side of the SEARCH button [2], the track advances ahead to the beginning of the next track.

● Track-down

1. Press the left side of the SEARCH button [2] to move back to the beginning of the current track.
2. Press the left side of the SEARCH button [2] twice to move to the beginning of the previous track.

Fast-forward/Fast-backward

● Fast-forward

Press and hold the right side of the SEARCH button [2] for 1 second or longer.

● Fast-backward

Press and hold the left side of the SEARCH button [2] for 1 second or longer.

Top function

The top function plays from the first track (track No. 1) of the disc.

● When playing a disc 1 to 6

Press the DIRECT button [13] (1 to 6) with the same number as the CD playing.

● When playing a disc 7 to 12 (only when a 12 disc CD changer is used.)

Press the DIRECT button [13] (7 to 12) with the same number as the CD playing for 1 second or longer.

Scan play

The scan play locates and plays the first 10 seconds of each track on a disc automatically. This function continues on the disc until it is cancelled or the mode is changed.

* The scan play is useful when you want to select a desired track.

1. Press the SCN button [5] to start scan play.
2. Press the SCN button [5] again to cancel the scan play. Current track continues to play.

Disc scan play

The disc scan play locates and plays the first 10 seconds of the first track on each disc in the currently selected CD changer. This function continues automatically until it is cancelled or the mode is changed.

* The disc scan play is useful when you want to select a desired CD.

1. Press the SCN button [5] for 1 second or longer to start disc scan play.
2. Press the SCN button [5] again to cancel disc scan play. Normal disc play continues on the current track.

Repeat play

The repeat play continuously plays the current track. This function continues automatically until it is cancelled or the mode is changed.

1. Press the RPT button **[7]**, to make repeat play starts. "RPT" lights in the display.
2. To cancel repeat play, press the RPT button **[7]** again. "RPT" goes off from the display and the unit returns to normal play.

Disc repeat play

After all tracks in the current disc have been played, the disc repeat play automatically replays the current disc over from the first track. This function continues automatically until it is cancelled or the mode is changed.

1. When you press the RPT button **[7]** for 1 second or longer, disc repeat play starts. "D-RPT" lights in the display.
2. To cancel disc repeat play, press the RPT button **[7]** again. "D-RPT" goes off from the display and the unit returns to normal play from the track being played.

Random play

The random play selects and plays individual tracks on the disc in no particular order. This function continues automatically until it is cancelled or the mode is changed.

1. When you press the RDM button **[8]**, random play starts. "RDM" lights in the display.
2. To cancel random play, press the RDM button **[8]** again. "RDM" goes off from the display and the unit returns to normal play.

Disc random play

The disc random play selects and plays individual tracks or discs automatically in no particular order. This function continues automatically until it is cancelled or the mode is changed.

1. When you press the RDM button **[8]** for 1 second or longer, disc random play starts. "D-RDM" lights in the display.
2. To cancel disc random play, press the RDM button **[8]** again. "D-RDM" goes off from the display and the unit returns to normal play from the track being played.

MD changer functions

When an optional MD changer is connected through the CeNET cable, this unit controls all MD changer functions. This unit can control a total of 2 changers (MD and/or CD).

Press the FNC button **[1]** and select the MD changer mode to start play. If 2 MD changers are connected, press the FNC button **[1]** to select the MD changer for play.

* If "NO DISC" appears in the display, load MDs into the MD changer.

Pausing play

1. Press the PLAY/PAUSE button **[3]** to pause play. "PAUSE" appears in the display.
2. To resume play, press the PLAY/PAUSE button **[3]** again.

Switching disc titles and track titles

This unit can display disc titles and track titles already entered on MDs. Titles up to 128 characters long can be displayed by scrolling the titles.

* Titles cannot be entered for MDs with this unit.

When the panel is closed:

1. Press the DISP button **[12]** to show the SUB display. The disc title or track title is displayed.
2. Each time you press and hold the DISP button **[12]** for 1 second or longer, the display toggles between the disc title and the track title.

When the panel is open:

Both disc and track titles are displayed.

Scrolling titles

When a title is longer than 16 characters (or 8 characters if the panel is closed), you can scroll through it with the following operation.

When the panel is closed:

1. Display the MD title (disc or track).
2. Press the BND button **[15]** for 1 second or longer. The display scrolls through the title.

When the panel is open:

1. Press the TITLE button **[24]** for 1 second or longer to scroll through the disc title.
2. To scroll the track title, press for 1 second or longer the TITLE button **[24]** within 30 seconds after scrolling the disc title.

MD Changer Operations

Notes:

- When the disc title is within 16 characters, the title is scrolled immediately.
- If the track title is shorter than 16 characters, the track titles does not scroll.

Selecting an MD

Each of the DIRECT button [13] corresponds to an MD loaded into the MD changer.

Press the DIRECT button [13] (1 to 6) and select the desired MD.

Selecting a track

● Track-up

1. Press the right side of the SEARCH button [2] to move ahead to the beginning of the next track.
2. Each time you press the right side of the SEARCH button [2], the track advances ahead to the beginning of the next track.

● Track-down

1. Press the left side of the SEARCH button [2] to move back to the beginning of the current track.
2. Press the left side of the SEARCH button [2] twice to move to the beginning of the previous track.

Fast-forward/Fast-backward

● Fast-forward

Press and hold the right side of the SEARCH button [2] for 1 second or longer.

● Fast-backward

Press and hold the left side of the SEARCH button [2] for 1 second or longer.

Top function

The top function plays from the first track (track No. 1) of the disc.

Press the DIRECT button [13] (1 to 6) with the same number that the MD playing.

- * If an MD is not loaded in a slot of the MD changer, pressing the DIRECT button [13] corresponding to its disc number is invalid.

Scan play

The scan play locates and plays the first 10 seconds of each track on a disc automatically. This function continues on the disc until it is cancelled or the mode is changed.

- * The scan play is useful when you want to select a desired track.

1. When you press the SCN button [5], scan play starts.
2. Press the SCN button [5] again to cancel the play. Current track continues to play.

Disc scan play

The disc scan play locates and plays the first 10 seconds of the first track on each disc in the currently selected MD changer. This function continues automatically until it is cancelled or the mode is changed.

- * The disc scan play is useful when you want to select a desired MD.

1. When you press the SCN button [5] for 1 second or longer, disc scan play starts.
2. To cancel disc scan play, press the SCN button [5] again. Normal disc play continues on the current track.

Repeat play

The repeat play continuously plays the current track. This function continues automatically until it is cancelled or the mode is changed.

1. When you press the RPT button [7], repeat play starts. "RPT" lights in the display.
2. To cancel repeat play, press the RPT button [7] again. "RPT" goes off from the display and the unit returns to normal play.

Disc repeat play

After all the tracks on the current disc have been played, the disc repeat play automatically replays the current disc over from the first track. This function continues automatically until it is cancelled or the mode is changed.

1. When you press the RPT button [7] for 1 second or longer, disc repeat play starts. "D-RPT" lights in the display.
2. To cancel disc repeat play, press the RPT button [7] again. "D-RPT" goes off from the display and the unit returns to normal play from the track being played.

Random play

The random play selects and plays individual tracks on the disc in no particular order. This function continues automatically until it is cancelled or the mode is changed.

1. When you press the RDM button [8], random play starts. "RDM" lights in the display.
2. To cancel random play, press the RDM button [8] again. "RDM" goes off from the display and the unit returns to normal play.

Disc random play

The disc random play selects and plays individual tracks or discs automatically in no particular order. This function continues automatically until it is cancelled or the mode is changed.

1. When you press the RDM button [8] for 1 second or longer, random play starts. "D-RDM" lights in the display.
2. To cancel random play, press the RDM button [8] again. "D-RDM" goes off from the display and the unit returns to normal play from the track being played.

DVD changer functions

When an optional DVD changer is connected through the CeNET cable.

In this case, this unit only provides a part of the DVD changer functions. As for other operations not written in this manual, operates with a remote control unit provided with your DVD changer. Refer to the DVD changer owners' manual for details.

This unit can control a total of 2 changers (CD or MD or DVD).

Press the FNC button [1] and select the DVD changer mode to start play.

- * If "NO MAGAZINE" appears in the display, insert the magazine into the DVD changer. "DISC CHECKING" appears in the display while the player loads (checks) the magazine.
- * If "NO DISC" appears in the display, eject the magazine and insert discs into each slot. Then, reinsert the magazine back into the DVD changer.

Pausing Play

1. Press and hold the PLAY/PAUSE button [3] to pause play. "PAUSE" appears in the display.
2. To resume play, press the PLAY/PAUSE button [3] again.

Slow Play (DVD video & video CD)

1. Press and hold the PLAY/PAUSE button [3] then press and hold the ►► button [2]. While the button is being pressed, slow playback continues at the speed 1/2 times the normal playback.
 - * Slow playback cannot be performed in the backward direction. In addition, audio cannot be reproduced during slow playback.

Selecting a disc

1. Each of the DIRECT buttons [13] corresponds to a disc loaded into the magazine.
2. Press the corresponding DIRECT buttons [13] (1 to 6) to select the desired disc.

Switching to a next disc(Disc Up function)

The disc up function plays from the first track (track No1) of the next disc.

1. Press the BND button [15].
2. Each time you press the BND button [15], the disc changes to the next disc.

DVD-Video Operation

Showing the DVD menu

1. Press the MENU button [25] during playback. The DVD menus appears.

The displayed contents may differ, depending on the DVD software.

- Example showing menu display



Using the title menu

On DVD discs containing two or more titles, you can select from the title menu for playback.

1. Press and hold the MENU button [25] for 1 second or longer during playback.

The title menu screen appears.

- Press the MENU button [25], and playback resumes from the scene played back before MENU button [25] is pressed.
 - Depending on the disc, the title menu cannot be called.
2. Operate the JOYSTICK [26] upward, downward, leftward or rightward to select an item.
 - Depending on the disc, items cannot be selected with the ten-key buttons on the DVD changer remote control unit.

Skipping a chapter(searching)

About chapter

Chapter means a small segment to divide the data area of the disc.

1. Press the right or left side of the SEARCH button [2] during playback.

Chapters are skipped, as many as the times the button is pressed, and playback starts.

- Press the ► button [2], and playback starts from the beginning of the next chapter.

- Press the ◀ button [2], and playback starts from the beginning of the current chapter.

When this button is pressed again within about 2 seconds, playback starts from the beginning of the previous chapter.

- The unit may return to the menu screen when the right or left side of the SEARCH button [2] is pressed.

Fast forward and fast backward

1. Press and hold the right or left side of the SEARCH button [2] during playback.

Press and hold the button, and the playback speed becomes 4-time faster first and then 16-time faster 3 seconds later. Release the button, and the normal speed is restored.

Notes:

- No audio is reproduced during fast forward and fast rewind operation.
- The fast forward and fast rewind speed may differ depending on the disc.
- The menu screen may appear when the button is pressed.

Scan playback

Scans and plays back all chapters recorded on the DVD-Video, the first 10 seconds for each.

1. Press the SCN button [5].
2. Press the SCN button [5] again and scan playback is turned off.

Chapter repeat playback

This operation plays back chapters recorded on the DVD-Video repeatedly.

1. Press the RPT button [7].
2. Press the RPT button [7] again and repeat playback is turned off.

Title repeat playback

This operation plays back titles recorded on the DVD-Video repeatedly.

1. Press and hold the RPT button [7] for 1 second or longer.
2. Press the RPT button [7] again and repeat playback is turned off.

Watching a video CD

Showing the V-CD menu (for V-CD discs with PBC (Play Back Control))

This key does not function on some discs.

1. Press the MENU button **[25]** during playback.
The V-CD menu appears.
The displayed contents may differ, depending on the V-CD software.
- Example showing menu display

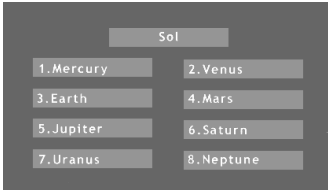

- * To select the menu contents, press the 10 key (DVD changer Remocon) according to the disc contents menu.

Skipping a track (searching)

1. Press the right or left side of the SEARCH button **[2]** during playback.
The track is skipped, and playback starts.
- Press the **▶▶** button **[2]**, and playback starts from the beginning of the next track.
- Press the **◀◀** button **[2]**, and playback starts from the beginning of the current track.

When this button is pressed again within about 2 seconds, playback starts from the beginning of the previous track.

- * This operation cannot be performed on some discs with PBC

Fast forward and fast backward

1. Press and hold the right or left side of the SEARCH button **[2]** during playback.
Press and hold the button, and the playback speed becomes 4-time faster first and then 16-time faster 3 seconds later. Release the button, and the normal speed is restored.

Notes:

- No audio is reproduced during fast forward and fast rewind operation.
- The unit may return to the menu screen when the button is pressed.

Scan playback

This operation plays back all tracks on the disc, the first 10 seconds for each.

1. Press the SCN button **[5]**.
2. Press the SCN button **[5]** again and scan playback is turned off.
 - * If you are playing a disc with PBC and the PBC function is engaged, this operation cannot be performed.

Repeat playback

This operation plays back one track recorded on the video CD repeatedly.

1. Press the RPT button **[7]**.
2. Press the RPT button **[7]** again and repeat playback is turned off.
 - * If you are playing a disc with PBC and the PBC function is engaged, this operation cannot be performed.

Random playback

This operation plays back all track on the disc in no particular order.

1. Press the RDM button **[8]**.
2. Press the RDM button **[8]** again and random playback is turned off.
 - * If you are playing a disc with PBC and the PBC function is engaged, this operation cannot be performed.

Listening to a CD

Skipping a track (searching)

1. Press the right or left side of the SEARCH button **[2]** during playback.
The tracks are skipped, as many as the times the button is pressed, and playback starts.
- Press the **▶▶** button **[2]**, and playback starts from the beginning of the next track.
- Press the **◀◀** button **[2]**, and playback starts from the beginning of the current track.

When this button is pressed again within about 2 seconds, playback starts from the beginning of the previous track.

Fast forward and fast backward

1. Press and hold the right or left side of the SEARCH button [2] during playback.

Press and hold the button, and the playback speed becomes 4-time faster first and then 8-time faster 3 seconds later. Release the button, and the normal speed is restored.

Scan playback

This operation plays back all tracks on the disc, the first 10 seconds for each.

1. Press the SCN button [5].
2. Press the SCN button [5] again and scan playback is turned off.

Track repeat playback

This operation plays back one track recorded on the CD repeatedly.

1. Press the RPT button [7].
2. Press the RPT button [7] again and repeat playback is turned off.

Disc repeat playback

This operation plays back all tracks on the disc repeatedly (with music CDs only).

1. Press and hold the RPT button [7] for 1 second or longer.
2. Press the RPT button [7] again and repeat playback is turned off.

Random playback

This operation plays back all track on the disc in no particular order.

1. Press the RDM button [8].
2. Press the RDM button [8] again and random playback is turned off.

Listening to an MP3

Skipping a track (searching)

1. Press the right or left side of the SEARCH button [2] during playback.

The tracks are skipped, as many as the times the button is pressed, and playback starts.

- Press the ► button [2], and playback starts from the beginning of the next track.

- Press the ◀ button [2], and playback starts from the beginning of the current track.

When this button is pressed again within about 2 seconds, playback starts from the beginning of the previous track.

- * This operation skips the track over the folder.

Fast forward and fast backward

1. Press and hold the right or left side of the SEARCH button [2] during playback.
Press and hold the button, and the playback speed becomes 4-time faster first and then 8-time faster 3 seconds later. Release the button, and the normal speed is restored.

Track scan playback

This operation plays back all files recorded on the disc, about 10 seconds for each.

1. Press the SCN button [5].
2. Press the SCN button [5] again and scan playback is turned off.

Folder scan playback

This operation plays back the first files of all folders on the MP3 disc, about 10 seconds for each.

1. Press and hold the SCN button [5] for 1 second or longer.
2. Press the SCN button [5] again and scan playback is turned off.

Track repeat playback

This operation plays back the file currently being played back repeatedly.

1. Press the RPT button [7].
2. Press the RPT button [7] again and repeat playback is turned off.

Folder repeat playback

This operation plays back files in an MP3 folder repeatedly..

1. Press and hold the RPT button [7] for 1 second or longer.
2. Press the RPT button [7] again and repeat playback is turned off.

Track random playback

This operation plays the file in the folder in random order.

1. Press the RDM button **[8]**.
2. Press the RDM button **[8]** again and random playback is turned off.

Folder random playback

This operation plays back tracks recorded on the disc in no particular order.

1. Press and hold the RDM button **[8]** for 1 second or longer.
2. Press the RDM button **[8]** again and random playback is turned off.

Selecting a file (track) on the screen

1. Press the MENU button **[25]** during playback. Files (tracks) are displayed.
2. Operate the JOYSTICK **[26]** upward or downward to select a file, and confirm it by pressing ENT at the center of the JOYSTICK **[26]**.
 - * If no further operation is performed for 7 seconds, the STANDARD screen is returned.

Notes:

- With the panel of the main unit closed, the remote control unit supplied with the DVD changer cannot be operated.
- While the panel of the main unit is closed, "DVD A/C" is shown on the information panel.
- While the car is moving, the panel displays the name of the current mode, time and "AUDIO PROGRAM ONLY".

TV functions

When an optional TV tuner is connected through the CeNET cable, this unit controls all TV tuner functions. To watch TV requires a TV tuner.

⚠ WARNING

For your safety, the driver should not watch the TV or operate the controls while driving. Please note that watching and operating the TV while driving are prohibited by law in some countries.

Watching TV

Notes:

- For your safety, the VRX633R has a safety function which turns off the picture when the car is moving, so only the audio can be heard. The picture can only be watched when the car is stopped and the parking break is applied.
- After setting a country to be received, tune in to a station. For setting the country, see the subsection "Setting the TV area".

1. Press the FNC button **[1]** and select the TV mode.
2. Press the BND button **[15]** to select the desired TV band (TV1 or TV2). Each time the button is pressed, the input selection toggles between TV1 and TV2.
3. Press the right or left side of the SEARCH button **[2]** to tune in the desired TV station.

Watching a video

The TV tuner has a VTR input terminal to which 1 external device can be connected. Connect a 12V video cassette player (VCP) or video cassette recorder (VCR) to the TV tuner input terminal.

1. Press the PTY/RDM button **[8]** and select the VTR.
2. To return to the TV broadcast, press the PTY/RDM button **[8]** again.

Tuning

There are 3 types of tuning mode available, seek tuning, manual tuning and preset tuning.

Seek tuning

1. Press the BND button [15] and select the desired TV band (TV1 or TV2).

* If "MANU" is lit in the display (or when the panel is closed, if the indicator "SRCH" is not lit), press and hold the BND button [15] for 1 second or longer. "MANU" in the display goes off (or when the panel is closed, the indicator "SRCH" lights) and seek tuning is now available.

2. Press the right or left side of the SEARCH button [2] to automatically seek a station. Press the right side of the SEARCH button [2] to automatically tune up the frequency band to the next available TV station; press the left side to automatically tune down.

Manual tuning

There are 2 ways available: Quick tuning and step tuning. When you are in the step tuning mode, the frequency changes one step at a time. In quick tuning mode, you can quickly tune the desired frequency.

1. Press the BND button [15] and select the desired band. (TV1 or TV2)

* If "MANU" is not lit in the display (or when the panel is closed, if the indicator "SRCH" is lit), press and hold the BND button [15] for 1 second or longer. "MANU" appears in the display (or when the panel is closed, the indicator "SRCH" goes off) and manual tuning is now available.

2. Tune into a station.

● Quick tuning:

Press and hold the right or left side of the SEARCH button [2] for 1 second or longer to tune in a station.

● Step tuning:

Press the right or left side of the SEARCH button [2] to manually tune in a station.

Note:

- Manual tuning is cancelled if you do not operate the unit for 7 seconds longer.

Recalling a preset station

A total of 12 TV stations can be stored (6-TV1 and 6-TV2). This allows you to select your favorite TV stations and store them in memory for later recall.

1. Press the BND button [15] and select the desired TV band. (TV1 or TV2)
2. To recall a stored TV station, press the desired PRESET button [13] to select that station.

- * Press and hold one of the PRESET buttons [13] for 2 seconds or longer to store the current station into the preset memory.

Manual memory

1. Select the desired station with seek tuning, manual tuning or preset tuning.
2. Press and hold one of the PRESET buttons [13] for 2 seconds or longer to store the current station to that preset memory.

Auto store

Auto store selects 6 TV stations automatically and stores each one into a preset memory.

If there are not 6 stations with good reception, stations previously stored in memory remain and only the strong stations are stored into memory.

1. Press the BND button [15] and select the desired TV band. (TV1 or TV2)
2. Press and hold the AS/PS button [5] for 2 seconds or longer. The stations with good reception are automatically stored to the PRESET buttons [13].

Preset scan

Preset scan allows the user to view each preset position before it automatically advances to the next preset. This function is useful for searching for desired TV station in memory.

1. Press the AS/PS button [5].
2. When the desired channel is received, press the AS/PS button [5] again.

Switching the VTR system between NTSC and PAL

* This function is enabled only when the panel is open.

Switch to the VTR or DVD changer mode you use.

1. Press the ADJ button [23] to switch to the adjustment selection display.
2. Operate the JOYSTICK [26] upward or downward to move the cursor to "VTR N/P".
3. Operate the JOYSTICK [26] rightward or leftward to move the cursor to select "NTSC" or "PAL".
4. Press the ENT at the center of the JOYSTICK [26] to set the selected VTR or DVD changer mode.

Setting the TV area

* This function is enabled only when the panel is open.

When you select the TV area (TV reception area), the TV tuner area setting changes.

1. Press the ADJ button **[23]** to switch to the adjustment selection display.
2. Operate the JOYSTICK **[26]** upward or downward to move the cursor to "TV AREA" and press the ENT at the center of the JOYSTICK **[26]** to display a list of country name.
3. Operate the JOYSTICK **[26]** upward or downward to select a desired country. Then press the ENT at the center of the JOYSTICK **[26]** to set it.
4. When the setting is finished, operate the JOYSTICK **[26]** rightward or leftward to move the cursor "MENU". Then press the ENT at the center of the JOYSTICK **[26]** to return to the adjustment selection display.

Setting the TV diver

* This function is enabled only when the panel is open.

* Normally use the TV diver with the "ON" position. You can change the reception setting for the TV antenna connected to the TV tuner.

1. Press the ADJ button **[23]** to switch to the adjustment selection display.
2. Operate the JOYSTICK **[26]** upward or downward to select "TV DIVER".
3. Operate the JOYSTICK **[26]** rightward or leftward to select "ON" or "OFF" and press the ENT at the center of the JOYSTICK **[26]** to set the selected reception setting.

● ON:

Sets reception emphasizing the visual.

● OFF:

Sets the diver setting to OFF.

4. Press the ADJ button **[23]** to return to the previous mode.

Adjusting the brightness and tone of color

Notes:

- This operation is available only when the car is stopped and the parking brake is applied.
- This function is not available when the display is stored.
- The HUE setting can be adjusted only when the NTSC mode is selected.

1. Press the BND button **[15]** to switch to the adjustment selection display.
2. Operate the JOYSTICK **[26]** upward or downward to select the option "MONI ADJ" (by moving the cursor).
3. Press the ENT at the center of the JOYSTICK **[26]**.
4. Operate the JOYSTICK **[26]** rightward or leftward to select "BRIGHT", "COLOR" or "HUE" (by moving the cursor).

● "BRIGHT":

Adjust the brightness of the display.

● "COLOR":

Adjusts the color saturation.

● "HUE":

Adjusts the tone of color (red is emphasized or green is emphasized.)

5. Operate the JOYSTICK **[26]** upward or downward to adjust a level.
6. When the adjustment is made, operate the JOYSTICK **[26]** rightward or leftward to move the cursor to "MENU". Then press the ENT at the center of the JOYSTICK **[26]** to return to the adjustment selection display.

Changing over TV display size

* This function is available only when the panel is open.

1. Press the DISP button [12] for 1 second or longer to display playback information such as screen size.
2. Each time you press the DISP button [12] for 1 second or longer to change over the TV display size, the TV display size changes in the following order:

"NORMAL" → "WIDE" → "F.WIDE" → "CINEMA" → "NORMAL"

● **"NORMAL"**: (normal display)

There is a black area at both right and left ends of a display. In case of normal TV broadcasting (4:3), the image can be shown without being cut or deformed.

● **"WIDE"**: (wide mode)

The image at right and left ends in a display elongates horizontally.

● **"F.WIDE"**: (full wide mode)

The whole image elongates horizontally.

● **"CINEMA"**: (cinema mode)

The image at both top and bottom in a display disappears.

Notes:

- When a normal 4:3 size image, not being a wide one, is viewed by displaying it fully on a wide TV display in a wide mode or a full-wide mode, a part of the peripheral image will be lacking or deformed. In deference to the intention of producer, an original image can be viewed in a normal mode.
- During superimposed display, it becomes a full-wide mode.
- In the DVD changer, when the monitor display size is set in the CINEMA mode, a part of playback display such as play time may not be shown depending on the play disc.

In this case, change the monitor display size to a mode other than the CINEMA mode.

Digital Radio/DAB Operations

About DAB programmes

The Digital Audio Broadcasting (hereinafter referred to as "DAB") system transmits several programmes on one frequency simultaneously, by compressing audio signals.

* The group of programmes, which is transmitted on a single frequency is called "ensemble".

* Some DAB stations have several ensembles and broadcast diversified programmes.

* The number of programmes and the contents which an ensemble provides depend on the broadcast stations and times. Since DAB programmes are broadcast on several different frequencies, the same programme can be enjoyed over large areas.

● A DAB station has multiple programmes on one frequency.

● When you turn the unit on and select DAB mode, the programme that starts is the one that was selected before when the power was turned off. If this programme is not available, another programme is selected automatically.

● Programmes have their own names, just like PS on RDS.

Note:

• For sophisticated audio quality, the receiver needs to tune on a DAB Ensemble. While the receiver is being tuned in to the DAB Ensemble, the Audio outputs are muted. The tuning time is not fixed.

Listening to the DAB

1. Press the FNC button [1] and select the DAB mode.
2. Press the right or left side of the SEARCH button [2] to tune in the desired station.

Tuning

There are 3 types of tuning mode available, seek tuning, manual tuning and preset tuning.

Seek tuning

1. Press the FNC button [1] to select DAB mode.
2. Press and hold right or left for 1 second or longer using the SEARCH button [2].
 - * The unit stops the seek tuning when it cannot find a DAB station. The display returns to the previous mode.

Manual tuning

1. Press the FNC button **[1]** to select DAB mode.
2. Press and hold the BND button **[15]** for 1 second or longer.
3. Select right or left to select a station using the SEARCH button **[2]**.
 - * The unit stops the seek tuning when it cannot find a DAB station. The display returns to the previous mode.

Note:

- Manual tuning is cancelled if you do not operate the unit for 7 seconds or longer.

Recalling a preset station

This unit has another preset memory function for DAB stations. Up to 18 stations (6 for each [MEM1], [MEM2] and [MEM3]) can be preset in the PRESET buttons **[13]**.

1. Press the FNC button **[1]** to select DAB mode.
2. Press the BND button **[15]** to select anyone of [MEM1], [MEM2] and [MEM3]. Each time you press the BND button **[15]**, the display changes in the following order:
[MEM1] → [MEM2] → [MEM3] → [MEM1]...
3. Press the corresponding the PRESET button **[13]** to recall the stored station.

Note:

- Press and hold one of the PRESET buttons **[13]** for 2 seconds or longer to store that station into preset memory.

Manual memory

1. Press the FNC button **[1]** to select DAB mode.
2. Press the BND button **[15]** to select anyone of [MEM1], [MEM2] and [MEM3].
3. Select the desired station using seek tuning, manual tuning or preset tuning, using the SEARCH button **[2]**.
4. Press and hold one of the PRESET buttons **[13]** for 2 seconds or longer to store the current station into preset memory.

Switching programmes

1. Press the FNC button **[1]** to receive a DAB station.
2. Select right or left to switch programmes in a DAB station using the SEARCH button **[2]**.

Note:

- Programmes may not be switched depending on DAB station or broadcasting time.

Programme scan

This function scans through each receivable programme in a DAB station being received for 10 seconds sequentially. This is useful when you want to search for a desired programme.

1. Press the FNC button **[1]** to receive a DAB station.
2. Press the PS/AS button **[5]**. The unit starts scanning each programme for 10 seconds sequentially.
3. When a programme which you want to listen is tuned in, press the PS/AS button **[5]** once again.

AF function

The AF function switches to a different frequency on the same network in order to maintain optimum reception.

- * The factory default setting is "ON".

● Switching OFF the AF function

Press the AF button **[7]**, the "AF" indicator goes off.

● Switching ON the AF function

Press the AF button **[7]**, the "AF" indicator lights.

- * If the reception of the current broadcast station deteriorates, "SEARCH" lights in the display and the radio searches for the same programme on another frequency.
- * When AF is ON, if the reception of an RDS broadcast deteriorates, the AF indicator flickers.

● AF function between RDS and DAB

Refer to the item of RDS tuner.

TA (Traffic Announcement)

In TA standby mode, when a traffic announcement broadcast starts, the traffic announcement broadcast is received as top priority regardless of the function mode so you can listen to it. Traffic programme (TP) automatic tuning is also possible.

- * RDS interrupt does not function during AM radio reception or in TV mode.

* This function can only be used when "TP" is lit in the display. When "TP" is lit, this means that the RDS broadcast station being received has traffic announcement programmes.

● Setting TA standby mode

If you press the TA button [10] when only "TP" is lit in the display, "TP" and "TA" light in the display and the unit is set into TA standby mode until a traffic announcement is broadcast. When a traffic announcement broadcast starts, "TRA INFO" appears in the display. If you press the TA button [10] while a traffic announcement broadcast is being received, the traffic announcement broadcast reception is cancelled and the unit goes into TA standby mode.

● Cancelling TA standby mode

With "TP" and "TA" lit in the display, press the TA button [10]. The "TA" indicator in the display goes off and TA standby mode is cancelled.

* If "TP" is not lit, pressing the TA button [10] searches for a TP station.

● Searching for a TP station

When "TP" is not lit, if you press the TA button [10], the "TA" in the display lights and the unit automatically searches a TP station.

Information standby mode

When the INFORMATION programme selected in the "INFO SEL" display of the adjustment mode starts, the unit switches to the selected INFORMATION programme automatically.

* For details on "Information select", refer to the procedure below.

1. Press the TA button [10], for 1 second or longer, "INFO" lights in the display and the unit is set to INFORMATION standby mode until INFORMATION starts.

* If you press the TA button [10] while the INFORMATION programme is being broadcast, the programme broadcast is cancelled and the unit enters INFORMATION standby mode.

2. To cancel INFORMATION standby mode, press the TA button [10] again for 1 second or longer.

Note:

• Only in case of DAB connection, this can be operated even in the RDS tuner mode.

Information select

This function allows selecting a type of INFORMATION on INFORMATION interrupt mode. You can set any of the 6 types of INFO below: TRAFFIC, WARNING, NEWS INFO, WEATHER, EVENTS, SP. EVENT

* This function is enabled only when the panel is open.

1. Press the ADJ button [23].
2. Operate the JOYSTICK [26] upward or downward to select "INFO SEL". Press the ENT at the center of the JOYSTICK [26] to change into the INFO selecting display.
3. Operate the JOYSTICK [26] upward or downward to select a desired INFORMATION. "ON" and "OFF" items are displayed to the right.
4. Operate the JOYSTICK [26] rightward or leftward to select "ON" and press the ENT at the center of the JOYSTICK [26] to set it.
5. When the setting is finished, operate the JOYSTICK [26] rightward or leftward to move the cursor to the "MENU". Then press the ENT at the center of the JOYSTICK [26] to return to the adjustment display.

PTY

This function enables you to listen to the selected programmes type, irrespective of the function mode.

* RDS interrupt does not function during AM radio reception or in TV mode.

* DAB and RDS have the same PTY.

* You can select one PTY from DAB or RDS.

* PTY broadcast are not yet available in all countries.

* In INFO standby mode, INFO stations have priority over PTY stations.

* In TA standby mode, TP stations have priority over PTY broadcasting station.

Selecting PTY

1. When you press the PTY button [8], the unit goes into PTY select mode.
2. Press any one of the PRESET buttons [13] to select the desired PTY. Alternatively, when the panel is closed, operate the SEARCH button [2] upward or downward to select a desired PTY.

* Below are the factory default settings stored for PRESET buttons [13].

Preset number	PTY item	
	ENGLISH	Contents
1	NEWS	News
2	INFO	Information
3	POP M	Pop music
4	SPORT	Sports
5	CLASSICS	Classics
6	M,O,R,M	Middle of the road music

3. The PTY select mode is cancelled automatically 7 seconds after a PTY is selected.

● Cancelling PTY standby mode

Press the PTY button [8] for 1 second or longer to turn off "PTY" in the display and cancel the PTY standby mode.

PTY seek

1. Press the PTY button [8], the PTY select mode is turned on.
2. Select a desired PTY.
3. Press the right or left side of SEARCH button [2]. If you press the right side, the unit seeks a PTY broadcast moving up the frequencies; if you press the left side, it seeks moving down the frequencies.

* If no station with the selected PTY broadcast can be received, the unit returns to PTY select mode.

PTY preset memory

1. Press the PTY button [8], the PTY select mode is turned on.
2. Select a desired PTY.
3. If you press and hold any one of the PRESET buttons [13] for 2 seconds or longer, the selected PTY is stored into that preset channel memory.

The following 29 types of PTY can be selected.

PTY item	
ENGLISH	Contents
NEWS	News
AFFAIRS	Today's events
INFO	Information
SPORT	Sports
EDUCATE	Education
DRAMA	Drama
CULTURE	Culture
SCIENCE	Science
VARIED	Variety
POP M	Pop music
ROCK M	Rock music
M,O,R, M	Middle of the road music
LIGHT M	Light music
CLASSICS	Classics
OTHER M	Other music
WEATHER	Weather
FINANCE	Finance
CHILDREN	For children
SOCIAL A	Social affairs
RELIGION	Religion
PHONE IN	Phone in
TRAVEL	Travel
HOBBIES	Hobbies
JAZZ	Jazz
COUNTRY	Country
NATIONAL	National
OLDIES	Oldies
FOLK M	Folk music
DOCUMENT	Documentaries

Operating the PTY SELECT display when the panel is open

1. Press the PTY button [8] to select the PTY SELECT display.
2. In the PTY SELECT display, PTY is selected and PTY memory can be adjusted.

Operate the JOYSTICK [26] rightward or leftward to select "PTY ITEM" or "PRESET" (by moving the cursor).

- When "PTY ITEM" is selected, PTY selection is carried out. Operate the JOYSTICK [26] upward or downward to select a desired PTY. Press the ENT at the center of the JOYSTICK [26] to set the selected PTY ITEM.
(The PTY ITEM thus set is listed at the lower right of the display.)
- When "PRESET" is selected, PTY preset memory can be called for and stored.
- Operate the JOYSTICK [26] upward or downward to select Preset Nos. 1 to 6.
- Press the ENT at the center of the JOYSTICK [26] to call for the preset PTY ITEM.
Press the ENT at the center of the JOYSTICK [26] for 2 seconds to store the PTY ITEM currently selected to any Preset No. selected (listed at the lower right).
- After adjustment is finished, operate the JOYSTICK [26] rightward or leftward to move the cursor to "MENU", and press the ENT at the center of the JOYSTICK [26] to return to STANDARD display.

Emergency broadcast

If an emergency broadcast is received, all the function mode operations are stopped. "ALARM" appears in the display and the emergency broadcast can be heard.

* RDS interrupt does not function during AM radio reception or in TV mode.

● Cancelling an emergency broadcast

If you press the AF Button [7], emergency broadcast reception is cancelled.

Volume setting of TA, emergency broadcast (ALARM), information and PTY

The volume for TA, ALARM, information and PTY interrupts can be set during TA, ALARM or PTY interrupts.

* The factory default setting is "15".

During a TA, ALARM or PTY interrupt, operate the VOLUME button [2] upward or downward to set the volume to the desired level (00 to 33).

* When the TA, ALARM, information or PTY interrupt ends, the volume returns to the level it had before the interrupt.

Dynamic Label Function

A dynamic label (hereinafter referred to as "DLS") is a text data associated with each DAB service. This set can display DLS up to 128 characters in a display.

* This function is enabled only when the panel is open.

DLS display mode

Press the TITLE button [24] for 1 second or longer to place in the DLS display mode. To cancel the DLS mode and return to the previous display, press the TITLE button [24] again. If there is a DLS data in the reception service, DLS text is displayed in the text displaying area.

A mark "▶" appears at the head of a whole text sentence (page), and a RETURN mark is indicated at the end point.

DLS memory

Up to six DLS, currently being received, can be stored. By pressing the PRESET button [13] 1 to 6 for 2 seconds or longer, the DLS page currently being displayed is stored. Operating the JOYSTICK [26] rightward or leftward moves a cursor to either P1 through P6, and pressing the ENT at the center of the JOYSTICK [26] for 2 seconds stores it.

DLS Calling

To call the DLS stored in the DLS memory, press the PRESET button [13]. The DLS in the DLS memory is displayed by 16 characters (2 lines) at the intervals of 5 seconds (automatic calling). To display at shorter intervals, press the PRESET button [13] while waiting for successive DLS character string to be displayed, the following DLS character string is displayed (manual calling).

With the DLS memory being called, move the cursor to "UPDATE" and press the ENT at the center of the JOYSTICK [26]. The display is changed into the DLS display being received.

NAVI Operations

NAVI functions

When Clarion Navigation (hereinafter referred to as NAVI) is connected, the following functions are enabled:

- Showing the NAVI display;
- NAVI operation using the unit key;
- NAVI guidance sound interruption;
- Remote operation of navigation functions by the remote controller through the optic sensor.

- * While interrupting the NAVI audio signal, an audio sound level is decreased and the NAVI guidance sound output is mixed.
- * NAVI guidance sound interruption is possible even when the panel is closed, however in this case, only the Audio Display is showed.

Setting Clarion NAVI as external input equipment

Be sure to perform this setting after connecting Clarion NAVI.

1. When the panel is open, press the ADJ button [23](#) to show the adjustment selection display.
2. Operate the JOYSTICK [26](#) upward or downward to select "INPUT". A menu bar is shown to the right to select the following items:
 - "NAVI": Setting when Clarion NAVI is connected;
 - "CCD": Setting when Clarion CCD camera is connected to this unit;
 - "RGB": Setting when a RGB image of other company's equipment is input;
 - "COM": Setting when a composite image of other company's equipment is input.
 - * These settings cannot be selected when the DVD changer is connected.
3. Operate the JOYSTICK [26](#) rightward or leftward to select "NAVI". Press ENT at the center of the JOYSTICK [26](#) to set connection of Clarion NAVI.

NAVI operation

Changeover between NAVI display and Audio/Visual (hereinafter referred to as AV) displays. When the panel is open, the NVG/AV button [11](#) has the same function as the NVG/AV button [11](#) on the NAVI remote controller to set a screen mode and a NAVI interruption.

Operate this button to change over between NAVI and AV displays.

- * When the NAVI Display/NAVI guidance sound in-

terruption setting (NAVI operation) is turned to the NAVI/NAVI mode on this unit, the audio sound level is decreased.

When the NAVI display is shown with the panel open, the following buttons are assigned to NAVI control functions, which correspond to the same functions as that of the same buttons on the NAVI remote controller.

JOYSTICK	26
MENU button	25
VIEW button	24
IN button	23
OUT button	22
SHORT button	17
RTN button	18
RPT/RPT+ button	19
ROUTE button	20
ICON button	21

Note:

- These buttons become normal audio operating buttons when changing into the AV display using the NVG/AV button [11](#).

CCD Camera

Monitoring the CCD camera

The CCD camera can be connected to this unit. For the power supply of the camera, mount the power box sold separately (CCA-188).

Notes:

- This function is not available when the display is stored.
- When the TV tuner and CCD camera are to be connected to this unit, connect the CCD camera to the CCD input terminal on this unit.
- Refer to the subsection "Sample System 3" in "9. SAMPLE SYSTEMS" section.

Setting CCD as an external input equipment

Be sure to perform this setting after connecting the CCD.

1. When the panel is open, press the ADJ button [23] to show the adjustment selection display.
2. Operate the JOYSTICK [26] upward or downward to select "INPUT". A menu bar is shown to the right to select the following items:
 - "NAVI": Setting when Clarion NAVI is connected;
 - "CCD": Setting when Clarion CCD camera is connected to this unit;
 - "RGB": Setting when a RGB image of other company's equipment is input;
 - "COM": Setting when a composite image of other company's equipment is input.
3. Operate the JOYSTICK [26] rightward or leftward to select "CCD". Press the ENT at the

Connecting other company's image equipment

center of the JOYSTICK [26] to set connection of the CCD.

RGB type or composite type images from other company's equipment can be displayed on this unit

Be sure to perform this setting after connecting the RGB type or composite type image equipment to the RGB terminal.

1. When the panel is open, press the ADJ button [23] to show the adjustment selection display.
2. Operate the JOYSTICK [26] upward or downward to select "INPUT". A menu bar is shown to the right to select the following items:
 - "NAVI": Setting when Clarion NAVI is connected;
 - "CCD": Setting when Clarion CCD camera is connected to this unit;
 - "RGB": Setting when a RGB image of other company's equipment is input;
 - "COM": Setting when a composite image of other company's equipment is input.
3. Operate the JOYSTICK [26] rightward or leftward to select "RGB" or "COM".
 - **To connect an RGB equipment:**

If the image equipment to connect is RGB type, select "RGB". Equipment capable to be connected should have positive polarity signal of 0.7 V p-p for RGB, and negative polarity signal of 0.3 V p-p for synchronous signal.

- **To connect a composite type equipment:** If the image equipment to connect is a "Composite" type, select "COM".

* These settings cannot be selected when the DVD changer is connected.

4. Then, press the ENT at the center of the JOYSTICK [26] to set the connection.

Display changeover

When the panel is open, it is possible to change over between AV display and external equipment display using the NVG/AV button [11].

* In the external equipment display, those buttons in the panel (JOYSTICK [26], MENU [25], VIEW [24], IN [23], OUT [22]) are disabled.

Other Functions

Always turning on the button illumination on the operation panel

Note:

• The following operation is enabled when the panel is open.

The button illumination on the operation panel when the display is turned upward, can be switched between "ON" and "OFF".

- "ON": Button illumination on the operation panel turns on for 5 seconds;
- "OFF" : Button illumination is always on when the power is turned on;

1. When the panel is open, press the ADJ button [23] to show the adjustment selection display.
2. Operate the JOYSTICK [26] upward or downward and select "AUTO ILL" to show "ON" and "OFF" in the menu bar.
3. Operate the JOYSTICK [26] rightward or leftward to select either position to be set and press the ENT at the center of the JOYSTICK [26] for setting.
4. Press the ADJ button [23] to return to the previous mode.
 - * To set "ON" again, switch "OFF" to "ON" manually.

Entering titles

Titles up to 10 characters long can be stored in memory and displayed for TV stations and CD changer. The numbers of titles that can be entered for each mode are as follows.

Mode	Number of titles
TV mode	15 titles

CD changer mode	Number of titles
DCZ628 connected	100 titles
CDC655z connected	60 titles
CDC655Tz connected	100 titles
CDC1255z connected	50 titles

* You cannot enter titles with the unit in Seek, Preset Scan, Auto store (TV), Scan, Repeat or Random (CD changer, MD changer) mode. Cancel each of those operations before entering titles.

1. Press the FNC button [1] to select the mode you want to enter a title (CD changer or TV).
2. Select and play a CD in the CD changer or tune in to a TV station for which you want to enter the title.
3. If you press and hold the TITLE button [24] for 1 second or longer, the display switches to the title input mode display.

4. Operate the JOYSTICK [26] upward or downward, rightward or leftward and move the cursor to the character to be entered. Press the ENT at the center of the JOYSTICK [26].

* When the cursor is at the lower/upper limit of the display, operate the JOYSTICK [26] upward or downward, the character string of the following line appears.

- "-->" : Space
- "<--" : Backspace
- "--|--" : Centering

5. Repeat the step 4 to enter the complete title.
6. Press and hold the ENT at the center of the JOYSTICK [26] for 2 seconds or longer to store the title into memory and cancel title input mode.

Title list play

You can display a list of titles, then select the disc or broadcast station to listen to from that list.

* You can not display a title list with the unit in Seek, Preset Scan, Auto store (Tuner, TV or DAB), Scan, Repeat or Random (CD changer or MD changer) mode. Cancel those operation modes before to display a title list.

1. With the unit in radio, CD/MD changer, TV or DAB mode, press the TITLE button [24]. A title list is displayed. The following functions can be carried out in a title list display.

● **TUNER:** PS name (for RDS) of frequency stored in the presets 1 to 6 or frequency is displayed;

● **DAB:** Service label of a channel stored in the presets 1 to 6 is displayed. When there is not any service label, "-----" is displayed.

● **CD/MD changer:** DISC titles for discs 1 to 6 are displayed (By changing over a display page in case of 12-CD changer, disc 7 to 12 can be displayed). When there is not any disc in a changer, "-----" is displayed.

● **TV:** A title of a channel stored in the presets 1 to 6 or a channel number is displayed.

2. Operate the JOYSTICK [26] upward or downward to select one of the items 1 to 6. Press ENT at the center of the JOYSTICK [26] to reproduce the selected broadcast station or disc.

* In case of 12-CD changer, move the cursor to disc 6 and then operate the JOYSTICK [26] downward to change over to a list display of discs 7 to 12.

3. Press the TITLE button [24] again to return to the STANDARD display.

Cellular phone interrupt setting

If you connect this unit and your cellular phone with a separately sold cable, you can listen to your telephone calls on your car speakers.

* The factory default setting is "OFF".

1. Press the ADJ button [23] to switch to the adjustment selection display.
2. Operate the JOYSTICK [26] upward or downward to select out of "TEL SW", "ON", "OFF", and "MUTE", which are displayed in the menu bar.

● OFF:

This unit continues normal operation even when the cellular phone is used.

Note:

- When the setting is OFF, disconnect the cellular phone from the cable or turn off the power of the cellular phone.

● ON:

You can listen to your telephone calls from the speakers connected to this unit.

* When listening to your calls on your car speakers, you can adjust the volume by operating the VOLUME button [2].

● MUTE:

The sound from this unit is muted during telephone calls.

3. Operate the JOYSTICK [26] rightward or leftward to select a desired mode, and then press the ENT at center of the JOYSTICK [26] to set it.
4. Press the ADJ button [23] again to return to the STANDARD display.

Setting the car speaker output for the cellular phone

* The factory default setting is "RIGHT".

* To output the telephone calls, set the cellular phone interrupt to ON.

1. Press the ADJ button [23] to switch to the adjustment selection display.
2. Operate the JOYSTICK [26] upward or downward to select "TEL SP", "LEFT" and "RIGHT" are displayed in the menu bar.

● LEFT:

Telephone calls can be heard on the left speaker connected to this unit.

● RIGHT:

Telephone calls can be heard on the right speaker connected to this unit.

3. Operate the JOYSTICK [26] rightward or leftward to select a desired mode, and then press the ENT at the center of the JOYSTICK [26] to set it.
4. Press the ADJ button [23] again to return to the STANDARD display.

9. IN CASE OF DIFFICULTY

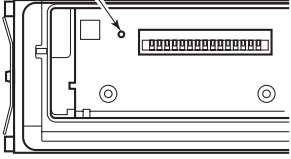
	Problem	Cause	Measure
GENERAL	Power does not turn on. (No sound is produced.)	Fuse is blown.	Replace with a fuse of the same amperage. If the fuse blows again, consult your store of purchase.
		Incorrect wiring.	Consult your store of purchase.
	Nothing happens when buttons are pressed. Display is not accurate.	The microprocessor has malfunctioned due to noise, etc.	Turn off the power, then press the RELEASE lever  and remove the DCP. Press the RESET button for about 2 seconds with a thin rod. The Reset button 
			DCP or main unit connectors are dirty.
	The remote controller does not work.	The display is not open.	The remote controller does not work unless the display is open.
		Direct rays of the sun fall on the light-receptive part of the remote controller.	When direct rays of the sun fall on the light-receptive part of the remote controller, it may not work.
The batteries of the remote controller unit are dead or there is no battery in the remote controller unit.		Check the batteries of the remote controller unit.	
TV	The image is not displayed.	The parking brake is not pulled.	Check that the parking brake is applied.
	The display is dark.	The brightness control is too low.	Adjust the brightness properly.
		The operating condition is not good.	The temperature inside the vehicle may be 0°C or less. Set to an appropriate temperature (25°C or so) and check it again.
		The headlight of the vehicle is lit.	The display is made dark at night to prevent the glare (When the headlight of the vehicle is lit in the daytime, the display gets dark).
	The color of the display is light or a shade of color is not good.	The color is not adjusted adequately.	Check that COL and HUE are adjusted properly.
When the VTR is connected, the image is disturbed.	Improper NTSC/PAL setting	Set the NTSC/PAL properly according to the VTR.	

	Problem	Cause	Measure
TV	When the TV tuner is connected, the image gets unclear.	Bad receiving condition	A radio wave may not reach sufficiently due to obstruction of mountains or buildings. Check it again at a place where a radio wave can be received properly.
	The TV tuner has a double or triple image.	Bad receiving condition	It may be under the influence of radio wave reflected by mountains or buildings. Check it again after changing place or direction.
	The TV tuner has spots or stripes in the image.	Presence of jamming	It may be under the influence from automobiles, streetcar, power cable, neon sign, and so forth. Check it again after changing place.
	There are red, green, and blue points in the display.	_____	This is not a failure, but a phenomenon peculiar to a liquid crystal panel (The LCD panel is produced according to technology with very high precision. Note that, though there are effective pixels of 99.99% or more, pixel missing or normally lit pixels account for 0.01%).

10. ERROR DISPLAYS

If an error occurs, one of the following displays is displayed. Take the measures described to eliminate the problem.

	Error Display	Cause	Measure
CD	ERROR 2	A CD is caught inside the CD deck and is not ejected.	This is a failure of CD deck's mechanism and consult your store of purchase.
	ERROR 3	A CD cannot be played due to scratches, etc.	Replace with a non-scratched, non-warped-disc.
	ERROR 6	A CD is loaded upside-down inside the CD deck and does not play.	Eject the disc then reload it properly.
CD CHANGER	ERROR 2	A CD inside the CD changer is not loaded.	This is a failure of CD changer's mechanism and consult your store of purchase.
	ERROR 3	A CD inside the CD changer cannot be played due to scratches, etc.	Replace with a non-scratched, non-warped-disc.
	ERROR 6	A CD inside the CD changer cannot be played because it is loaded upside-down.	Eject the disc then reload it properly.
MD CHANGER	ERROR H	Displayed when the temperature in the MD changer is too high and playback has been stopped automatically.	Lower the surrounding temperature and wait for a while to cool off MD changer.
	ERROR 2	An MD inside the MD changer is not loaded.	This is a failure of MD changer's mechanism and consult your store of purchase.
	ERROR 3	An MD inside the MD changer cannot be played due to scratches, etc.	Replace with a non-scratched, non-warped-disc.
	ERROR 6	An MD inside the MD changer cannot be played because it is loaded upside-down.	Eject the disc then reload it properly.
Displayed when a non-recorded MD is loaded in the MD changer.		Load a pre-recorded MD in the MD changer.	

If an error display other than the ones described above appears, press the RESET button. If the problem persists, turn off the power and consult your store of purchase.

For the DVD changer, refer to the Owner's Manual provided with the DVD changer.

11. SPECIFICATIONS

FM (UKW) Tuner

Frequency range:
87.5 MHz to 108 MHz (0.05 MHz steps)

AM Tuner

Frequency range:
MW: 531 kHz to 1602 kHz (9 kHz steps)
LW: 153 kHz to 279 kHz (3 kHz steps)

Audio Amplifier

Rated power output:
17 W × 4 (20 Hz to 20 kHz, 1%, 4 Ω)
Maximum power output: 46 W × 4
Speaker impedance: 4 Ω (4 to 8 Ω)

Input

RGB input:
Video: 0.7 +/- 0.2 Vp-p (input impedance 75 Ω)
Synchronize: 0.3 V (+0.9 / -0.1) Vp-p (input impedance: 75 Ω)
Video input:
1.0 +/- 0.2 Vp-p (input impedance 75 Ω)

Output

Audio output: min.200mVrms

LCD Monitor

Screen Size:
6.5-inch wide type (142 mm Width × 78 mm Height)
Display method: Transmission type TN liquid crystal display
Drive method: TFT (thin-film transistor) active matrix driving
Pixels:
280,800 (1200 × 234)

General

Power source voltage:
14.4 V DC (10.8 to 15.6 V allowable)
Ground:
Negative
Current consumption:
4.0 A (1 W)
Auto Antenna Rated Current:
500 mA less
Dimensions of the Main Unit:
178 mm Width × 50 mm Height × 157 mm Depth
Weight of the Main Unit:
1.7 kg
Dimensions of the Remote Control Unit:
44 mm Width × 110 mm Height × 27 mm Depth
Weight of the Remote Control Unit:
30 g (including battery)

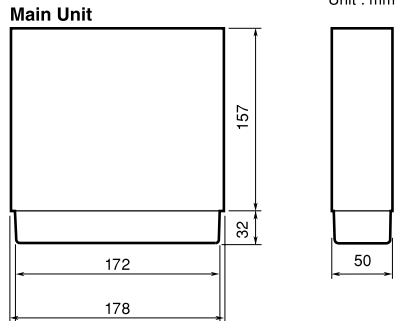

Notes:

- Specifications comply with EIAJ Standards.
- Specifications and design are subject to change without notice for further improvement.

Free Manuals Download Website

<http://myh66.com>

<http://usermanuals.us>

<http://www.somanuals.com>

<http://www.4manuals.cc>

<http://www.manual-lib.com>

<http://www.404manual.com>

<http://www.luxmanual.com>

<http://aubethermostatmanual.com>

Golf course search by state

<http://golfingnear.com>

Email search by domain

<http://emailbydomain.com>

Auto manuals search

<http://auto.somanuals.com>

TV manuals search

<http://tv.somanuals.com>