

Clarion®

MSS7100

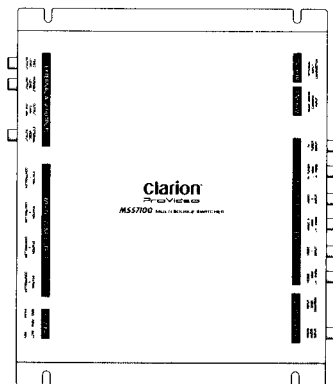

MULTISOURCE SWITCHER

OWNER'S MANUAL INSTALLATION GUIDE

WARNING!

THE CLARION MSS7100 MULTISOURCE SWITCHER IS DESIGNED FOR SWITCHING OF VIDEO SOURCES FOR REAR SEAT VIEWING ONLY.

THIS PRODUCT IS NOT INTENDED FOR VIEWING BY THE DRIVER WHILE THE VEHICLE IS IN MOTION SINCE SUCH USE MAY DISTRACT THE DRIVER OR INTERFERE WITH THE DRIVER'S SAFE OPERATION OF THE VEHICLE AND MAY RESULT IN SERIOUS INJURY OR DEATH. SUCH USE MAY ALSO VIOLATE STATE LAW.

CLARION DISCLAIMS ANY LIABILITY FOR ANY BODILY INJURY, INCLUDING FATALITIES, OR PROPERTY DAMAGE THAT MAY RESULT FROM ANY IMPROPER OR UNINTENDED USES OF THIS PRODUCT.

ABOUT INSTALLATION

Installation of mobile audio and video components requires experience with a variety of mechanical and electrical procedures. Even though this manual provides general installation and operation instructions for your new Clarion MSS7100 Multisource Switcher, it does not show the exact installation methods for your particular vehicle.

If you do not have the required knowledge and experience to successfully complete the installation, we strongly recommend consulting an authorized Clarion Pro Audio dealer about professional installation options.

TABLE OF CONTENTS

<i>Introduction</i>	3
<i>Installation And Operation Precautions</i>	4
<i>Description Of TCS101 Control Station</i>	6
<i>Operating The MSS7100 System</i>	8
<i>Applications</i>	10
<i>Description Of MSS7100 Connectors</i>	16
<i>Installation and Wiring</i>	20
<i>Troubleshooting</i>	25
<i>Specifications</i>	26
<i>FCC Statement</i>	26
<i>TCS101 Mounting Template</i>	27

INTRODUCTION

The Clarion MSS7100 is a full-featured multisource switcher specifically created for the mobile environment. When used with the enclosed pair of TCS101 Control Stations, the system allows true multi-zone control with independent audio/video selection of up to six sources and connection of up to four monitors, each capable of displaying a different audio/video program. At each station, volume and source selection controls provide individual entertainment, as well as private listening via a headphone jack.

The MSS7100 also includes the following features:

- Works with Clarion monitors
- Accepts up to four individual TCS101 Control Stations
- All solid-state electronic circuits
- Audio mute during source selection
- Buffered input and output audio/video circuits
- Entertainment lock-out capability

- Gold-plated RCA connectors
- High-quality video/audio switcher circuits
- Camera override circuit

About The Manual And Warranty

To start enjoying your new Clarion MSS7100 system, please read all remaining instructions listed in this manual. Keep all instructions for future reference.

This product is covered by a limited warranty (see the enclosed warranty card). Save the sales receipt to protect your purchase and aid in warranty service.

INSTALLATION AND OPERATION PRECAUTIONS

Installation Precautions

- This unit operates on an automotive 12-volt negative ground power source and requires additional mobile audio and video components for proper operation.
- Before installation, disconnect the (-) negative lead from the vehicle's battery.
- Use only supplied screws and hardware. Make sure all connections and components are fastened securely.
- At the proposed installation sites, make sure there is adequate space to accommodate both MSS7100 and TCS101 dimensions (see *Installation* on page 20).
- Use extreme caution when drilling around electrical wiring, brake lines, and fuel lines. Check clearances on both sides of a planned installation surface before drilling any holes or installing any screws.
- Always wear protective eyewear when using tools.

- Use only high-quality RCA cables that are no longer than necessary for direct connections to other components in the system. Extra-length audio and video cables can cause signal loss and act as an "antenna" for noise.
- When routing RCA cables, keep them away from power cables and output speaker wires.
- If a fuse needs replacement, use the same value as the original. Do not substitute another rating.

Operation Precautions

- Do not allow liquids or foreign objects to enter the MSS7100 Switcher or TCS101 Control Station(s).
- If any unit should become wet, turn off all power and let your authorized Clarion Pro Audio dealer clean or service the equipment.

DO NOT ATTEMPT TO OPEN OR SERVICE THE MSS7100 OR TCS101. THE INTERNAL PARTS ARE NOT USER-SERVICEABLE. DOING SO WILL VOID THE WARRANTY.

- Do not place heavy objects on the MSS7100 Switcher or TCS101 Control Station(s).
- Do not drop or excessively jar the MSS7100 Switcher or TCS101 Control Station(s).
- Do not use liquid cleaners on any surfaces. Only use a soft (cotton or other non-static) cloth to wipe off fingerprints or other imprints from the faceplate or remote control.
- Do not subject the unit to direct sunlight or an extremely hot environment (e.g., closed windows on a hot summer day, direct path of heater vent, etc.).
- Avoid using the products under the following conditions:
 - After extended parking on an extremely hot or cold day
 - Near strong magnetic fields
 - In an environment with excessive humidity, dust, or vibration (e.g., off-road travel, etc.)

DESCRIPTION OF TCS101

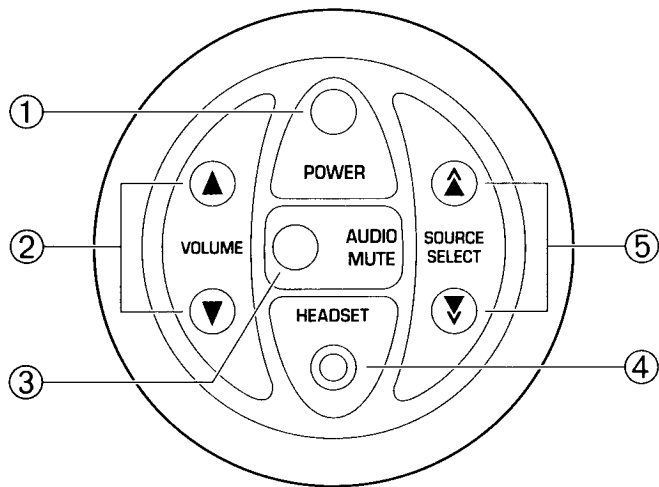

Figure 1. The TCS101's controls, power indicator, and phone jack (see descriptions starting on the right).

① POWER Button (Control Station 1 Only)

When +12 V is applied to the MSS7100's Remote-On wire, Station 1's LED (below the POWER button) will glow green and backlight the faceplate as the unit is powered on automatically. To turn off Station 1, press POWER again.

POWER Button (Control Stations 2 ~ 4 Only)

For these stations, the power on indication is the same as Station 1, except the units **will not** power on automatically. At each station, press POWER once to turn power on. Press it again to turn it off.

NOTE: After initial turn-on:

- If Remote-On shuts down for less than 60 seconds, the Control Stations will automatically come back on and remember the last volume and selection settings.*
- If Remote-On shuts down for more than 60 seconds, the power for Stations 2 ~ 4 will not automatically come back on. You'll need to press POWER at each station to activate the unit and recall the last volume and selection settings.*

② VOLUME Controls

Press the Up (or Down) button to increase (or decrease) headphone volume. Each button press increases (or decreases) volume by 1 dB. Holding a button down automatically increases (or decreases) volume in 2 dB steps.

NOTE: The initial volume setting is 0 dB. You'll need to press and hold the Up button to reach a desirable listening level. Once set, the MSS7100 will remember the last setting and return to it the next time the switcher is on.

③ AUDIO MUTE Control

Press the AUDIO MUTE button once to mute the headset volume for the Control Station. Press AUDIO MUTE again or press either the VOLUME Up or Down button to cancel mute.

NOTE: During mute, pressing either the SOURCE SELECT Up or Down button will not cancel mute.

④ HEADSET (1/8" Headphone Jack)

Connect a set of stereo headphones (not included) for private listening at each station.

⑤ SOURCE SELECT Controls

Press the SOURCE SELECT Up (or Down) button one or more times to step through the different Audio/Video inputs. Each press of a Up (or Down) button selects the next input source according to the following sequences:

(for SOURCE SELECT Up)

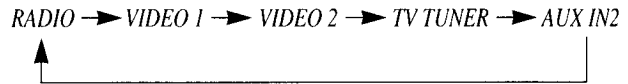

(for SOURCE SELECT Down)

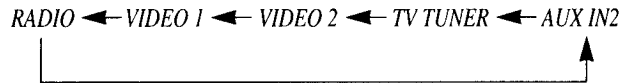

OPERATING THE MSS7100 SYSTEM

Powering The MSS7100 System On

1. To power on the MSS7100 system, turn on the audio system's power.
2. The TCS101 at Control Station 1 will become active (i.e., backlit LED glows green). The attached TV monitor will also turn on and will display the last selected source.

NOTE: The TV monitor may be blank if the selected source is not active (e.g., VCP is not playing a videocassette). However, unless the parking brake is engaged, video will be locked out and only the audio channels will be active.

Powering Control Stations 2 ~ 4 On and Off

1. After system power is on, press the POWER button once on the TCS101 for Control Station 2, 3, or 4. The attached TV monitor for the station will also turn on and will display the last selected source.

NOTE: The TV monitor may be blank if the selected source is not active (e.g., VCP is not playing a videocassette).

2. To turn off a station, press its POWER button again. The station's attached TV monitor will turn off.

Viewing A Videocassette (Or DVD)

1. After system and individual control station power is on, insert a videocassette in the VCP (or DVD player) and press PLAY.
2. At a Control Station, press the SOURCE SELECT Up (or Down) button one or more times until you see the video program on the Control Station's TV monitor.

NOTE: For driver safety, videocassette (or DVD) playback will only appear on Control Station 1's TV monitor when the vehicle's parking brake is engaged. If the parking brake is off, video will be locked out and only the audio channels will be active.

3. Adjust the audio system's volume control to a desired listening level.

NOTE: For private listening, insert a pair of headphones into a station's HEADSET jack and press the TCS101's Up (or Down) controls to a desired listening level (also see description of VOLUME Controls on previous page).

Viewing A Video Game (If Installed)

1. After system and individual control station power is on, power on the video game player and insert a desired game cartridge.
2. At a Control Station, press the SOURCE SELECT Up (or Down) button one or more times until you see the video game on the Control Station's TV monitor.

NOTE: For driver safety, videocassette (or DVD) playback will only appear on Control Station 1's TV monitor when the vehicle's parking brake is engaged. If the parking brake is off, video will be locked out and only the audio channels will be active.

3. Adjust the audio system's volume control to a desired listening level.

NOTE: For private listening, insert a pair of headphones into a station's HEADSET jack and press the TCS101's Up (or Down) controls to a desired listening level (also see description of VOLUME Controls on page 7).

Viewing The Rear Vision Camera (Control Station 1 Only)

If your system is equipped with this option, you can view the Rear Vision Camera as follows:

1. To turn on the Rear Vision Camera, place the vehicle in reverse gear. The video monitor at Control Station 1 will automatically display the Rear Vision Camera output.

NOTE: In this mode, video switching is defeated. However, pressing the SOURCE SELECT buttons will still switch audio.

2. To turn off the Rear Vision Camera, place the vehicle in any gear other than reverse. The video monitor at Control Station 1 will automatically display the last selected video source.

NOTE: Once the vehicle is taken out of reverse, full control will be restored to the SOURCE SELECT buttons. However, unless the parking brake is engaged, the system will automatically disable all video source selections except data from AUX IN2 (e.g., future navigation product). All audio will still be available for source selection.

Clarion MSS7100 MULTISOURCE SWITCHER

APPLICATIONS

The MSS7100 can be used in a variety of sophisticated mobile applications. We've enclosed six example systems to help plan your own installation (see Figures 2 through 7).

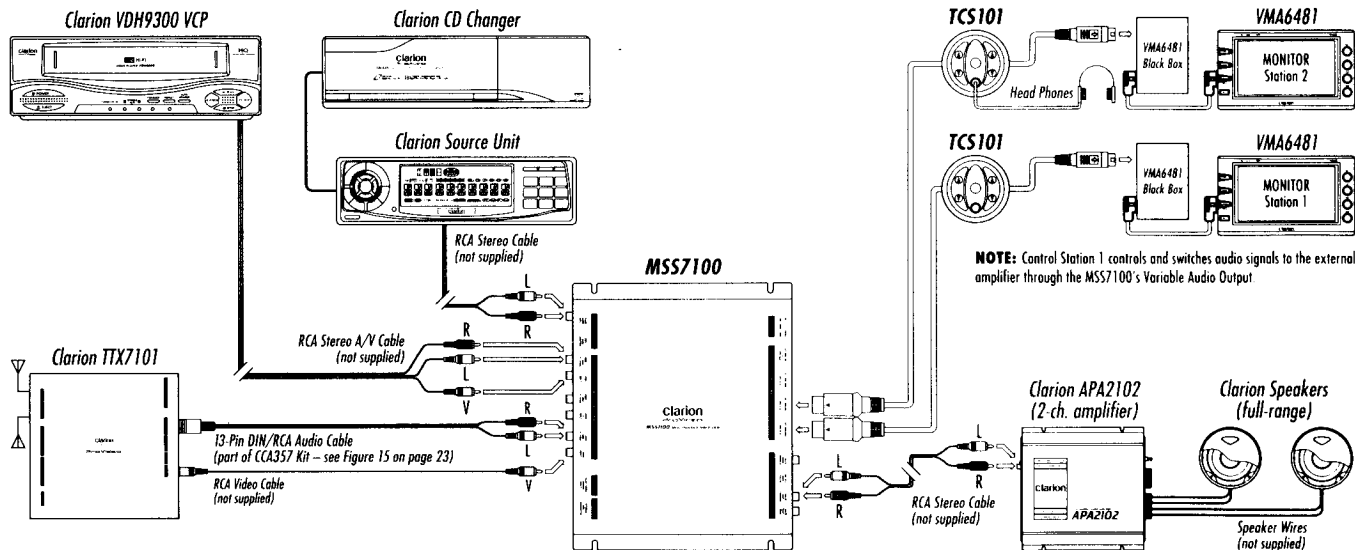

Figure 2. Using the MSS7100 in a basic system.

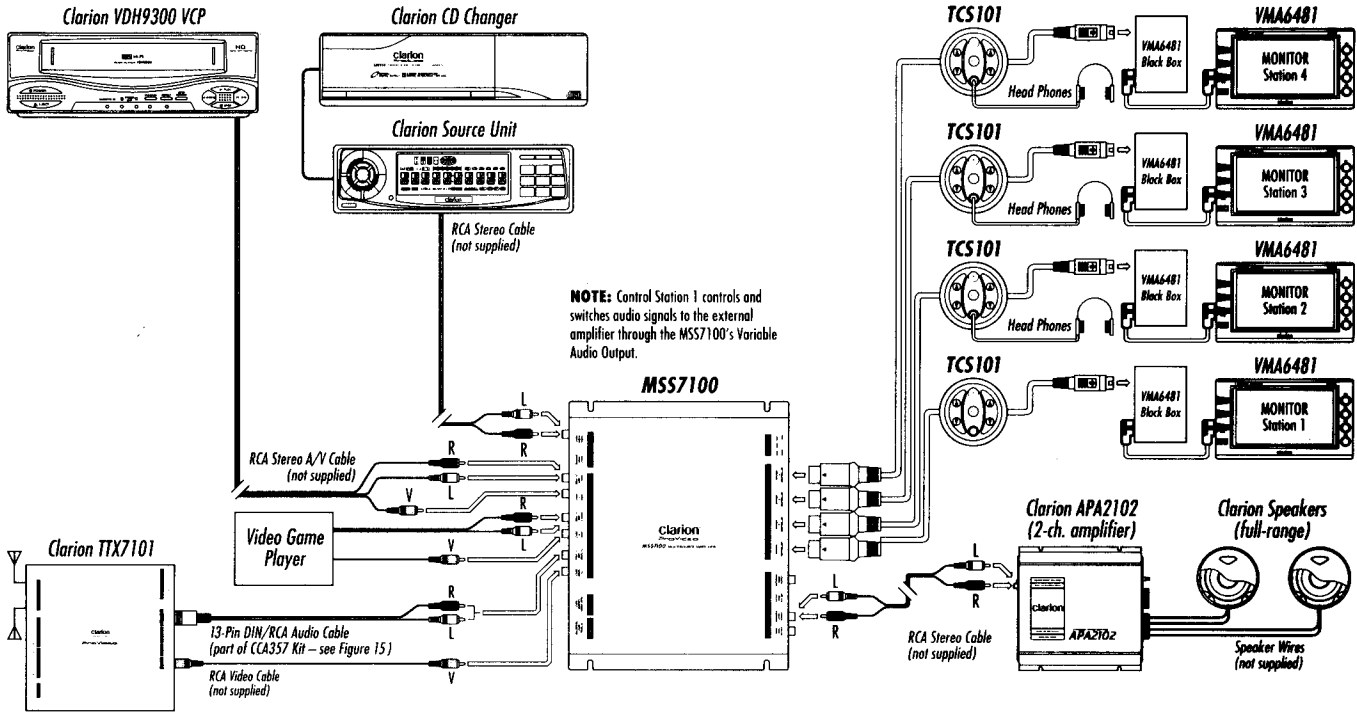

Figure 3. Using the MSS7100 in an expanded system.

Clarion MSS7100 MULTISOURCE SWITCHER

APPLICATIONS (CONTINUED)

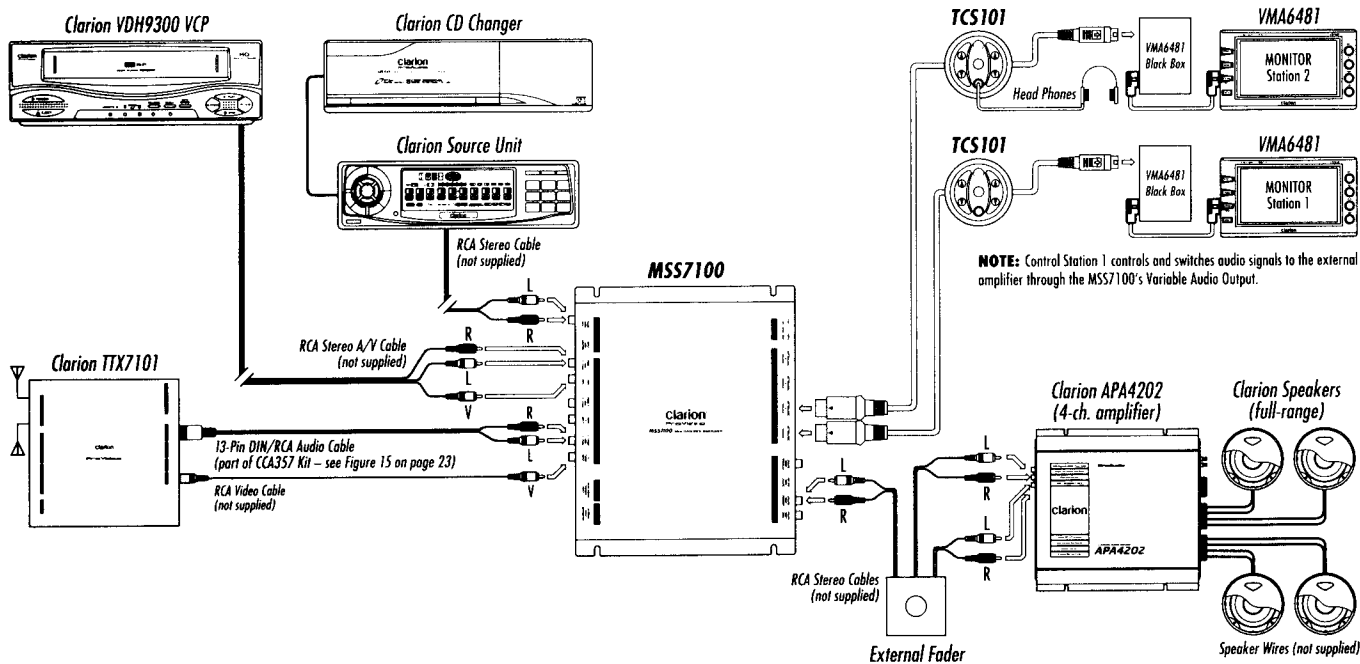

Figure 4. Using the MSS7100 with a 4-channel amplifier.

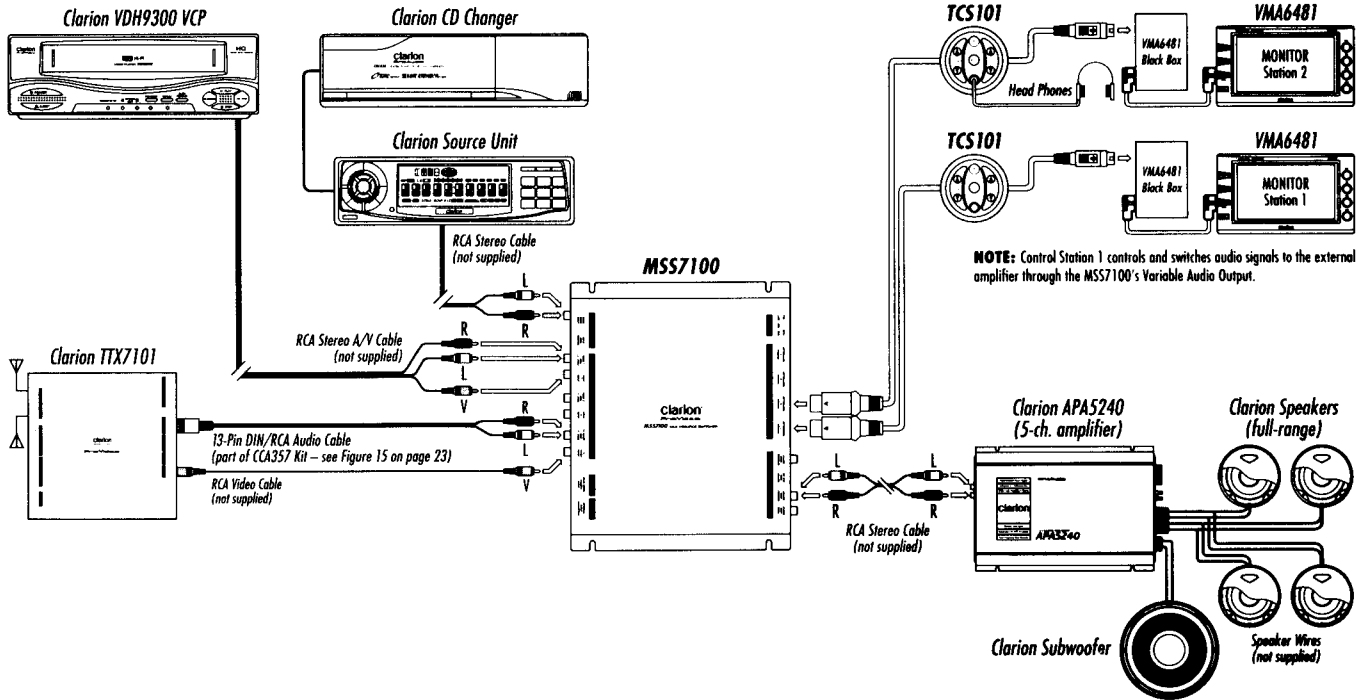

Figure 5. Using the MSS7100 with a 5-channel amplifier.

Clarion MSS7100 MULTISOURCE SWITCHER

APPLICATIONS (CONTINUED)

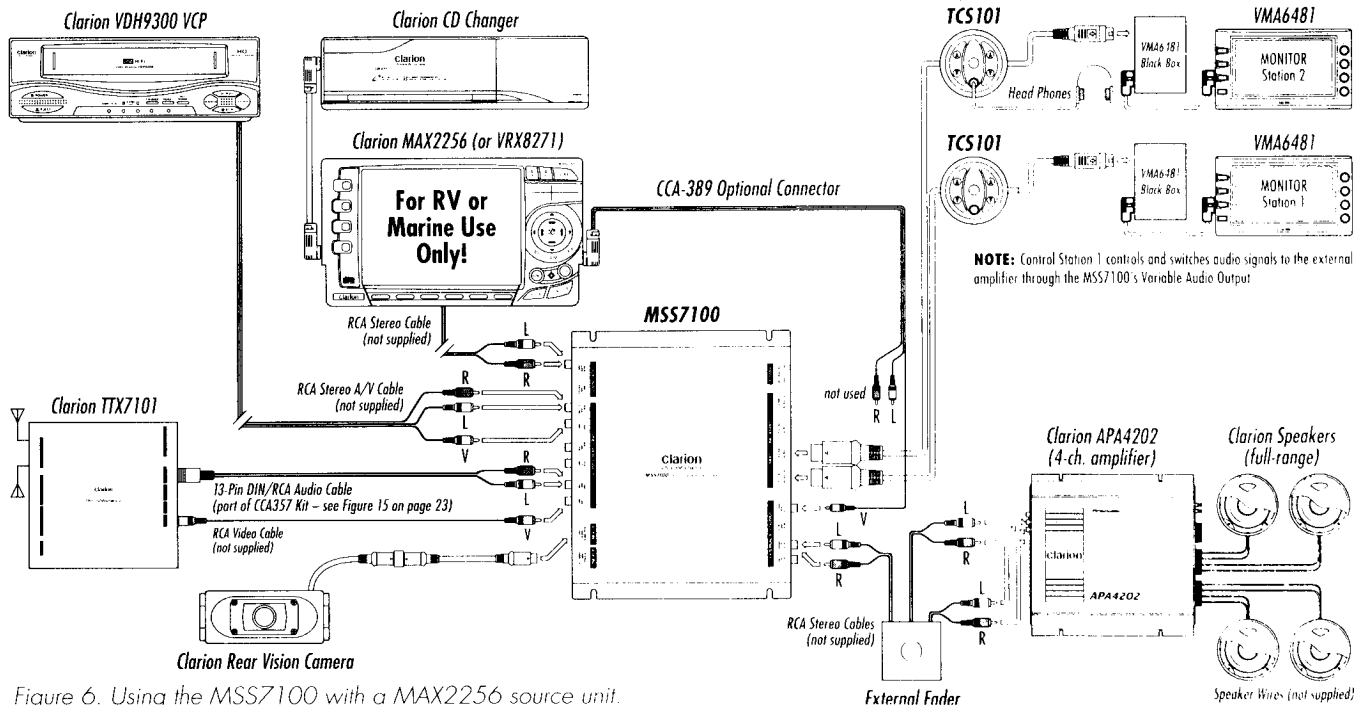

Figure 6. Using the MSS7100 with a MAX2256 source unit.

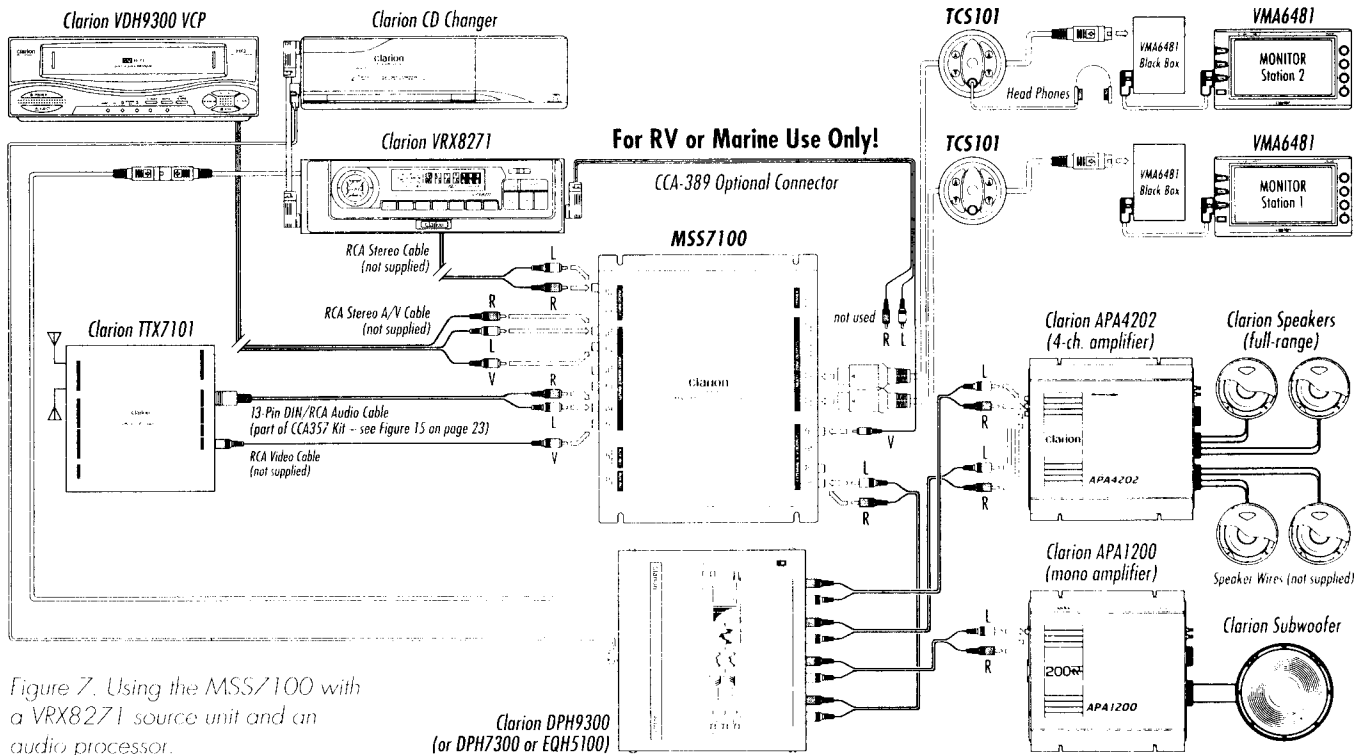

Figure 7. Using the MSS7100 with a VRX8271 source unit and an audio processor.

Clarion *MSS7100* MULTISOURCE SWITCHER

DESCRIPTION OF MSS7100 CONNECTORS

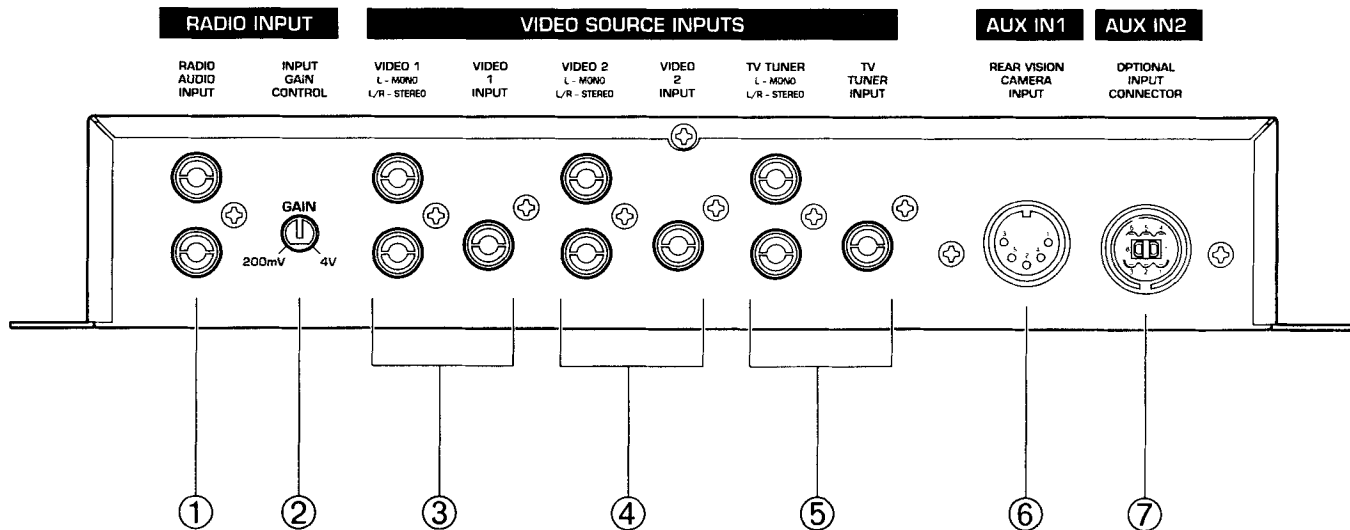

Figure 8. The MSS7100's input connectors (see descriptions on the next page).

A/V Input Connections (Front Panel)**① RADIO AUDIO INPUT L/R (2 -RCA Jacks)**

Use an RCA stereo audio cable (not supplied) to connect from the source unit's low-level (i.e., 200 mV to 4 V max.) RCA stereo audio jacks to the MSS7100 switcher.

NOTE: Do not connect these jacks to the source unit's speaker-level wires.

② (RADIO) INPUT GAIN Control

With the source unit at 3/4 volume position, use this control to set the level of incoming radio/tape stereo audio. Adjust the gain control so that the source unit's level matches the audio level of Video 1 or Video 2.

③ VIDEO 1 INPUT (3-RCA Jacks)

Use a triple RCA A/V cable (not supplied) to connect video and stereo audio from the primary video source (e.g., Clarion VDH9300 Hi-Fi VHS VCP, DVD, etc.) to the MSS7100 switcher. If the video source has only a mono audio output, connect it only to the L input to drive both channels of the MSS7100 switcher.

④ VIDEO 2 INPUT (3-RCA Jacks)

Same as VIDEO 1 INPUT. Use these jacks to connect a second video source (e.g., video game console).

⑤ TV TUNER INPUT (3-RCA Jacks)

Use an optional CCA357 "stand-alone kit" and a high-quality RCA video cable (not supplied) to connect the TTX710 TV Tuner's video and stereo audio to the MSS7100 switcher. If your TV tuner has only a mono audio output, connect it only to the L input to drive both channels of the MSS7100 switcher.

⑥ AUX IN 1 (8-pin DIN for Clarion Rear Vision Cameras)

Use to connect one of Clarion's optional Rear Vision Cameras directly to the MSS7100 switcher for it to supply all power and remote signals including automatic video switching to Video Station 1 when the vehicle is put into reverse (see *Installation* on page 20).

⑦ AUX IN 2 (Optional Input Connector)

Connector for future Clarion Multimedia products. Contact your local authorized Clarion Pro Audio dealer for compatible products and availability.

Clarion **MSS7100 MULTISOURCE SWITCHER**

DESCRIPTION OF MSS7100 CONNECTORS (CONT'D)

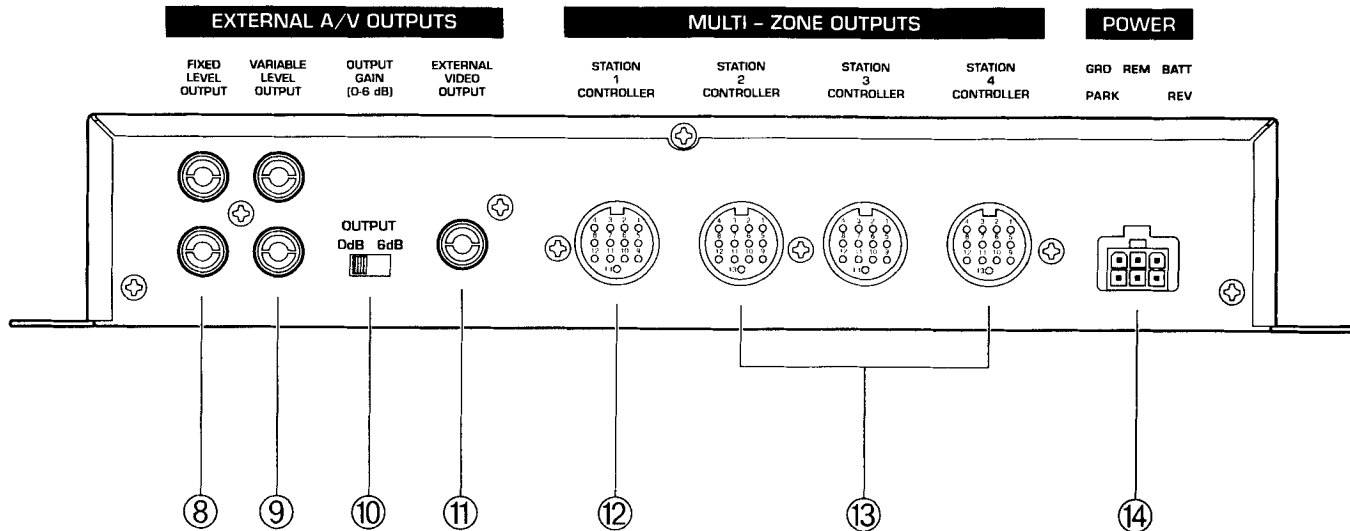

Figure 9. The MSS7100's output and power connectors (see descriptions on the next page).

A/V Output Connections (Rear Panel)**⑧ FIXED LEVEL OUTPUT L/R (2-RCA Jacks)**

Maximum output level is $2 V_{\text{rms}}$. Use this output when a fixed input level is required to connect the MSS7100 to stereo inputs on a processor or pre-amp controller.

NOTE: A TCS101 will switch and control the audio output when it's connected to the STATION 1 CONTROLLER. No audio will be present when there is no connection.

⑨ VARIABLE LEVEL OUTPUT L/R (2-RCA Jacks)

Maximum output level is $3.14 V_{\text{rms}}$. Use this output when a variable input level is required to connect the MSS7100 to stereo inputs on external amplifiers or processors.

NOTE: Same note as FIXED LEVEL L/R above.

⑩ OUTPUT GAIN (0/6 dB) Switch

Use this switch to set the VARIABLE LEVEL OUTPUT. In the 0 dB position, the output level is equal to the input. In the 6 dB position, the output level is twice the input.

NOTE: Do not use the 6 dB position if the input audio level already exceeds $2 V_{\text{rms}}$. Doing so will cause distortion.

⑪ EXTERNAL VIDEO OUTPUT (1-RCA jack)

Use this output when connecting the MSS7100 to an external (NTSC-composite type) video monitor for Zone 1.

NOTE: A TCS101 will switch and control the video output when it's connected to the STATION 1 CONTROLLER. No video will be present when there is no connection.

Multi-Zone Output Connections (Rear Panel)**⑫ STATION 1 CONTROLLER (13-pin DIN)**

A TCS101 controller connected here provides selection and control of Zone 1 audio/video signals, external RCA outputs, and Rear Vision Camera display.

⑬ STATION 2 ~ 4 CONTROLLERS (13-pin DIN)

TCS101 controllers connected here provide selection and control of Zone 2, Zone 3, and Zone 4 audio signals.

Power Connections (Rear Panel)**⑭ POWER (6-pin Molex jack)**

Connect the enclosed Molex pigtail to the vehicle's power, ground, parking brake and back-up light circuits, and source unit's remote-on lead (see Figure 12 on page 21).

Clarion MSS7100 MULTISOURCE SWITCHER

INSTALLATION AND WIRING

Parts List

- (1) MSS7100 Multisource Switcher
- (2) TCS101 Control Stations
- (4) M4 x 15 Self-tapping Sheet Metal Screws
- (1) 6-pin Molex Power Connector
- Owner's Manual/Installation Guide
- Warranty Registration Card

Suggested Tools and Other Parts

NOTE: The tools listed below may be required for basic installation of your new Clarion MSS7100 Multisource Switcher. Other tools and parts may be necessary for custom installations.

- An electric drill with bit assortment
- 2.25" (57mm) hole saw
- Saber saw or nibbling tool
- Phillips-head and flat-blade screwdrivers

Installing the MSS7100

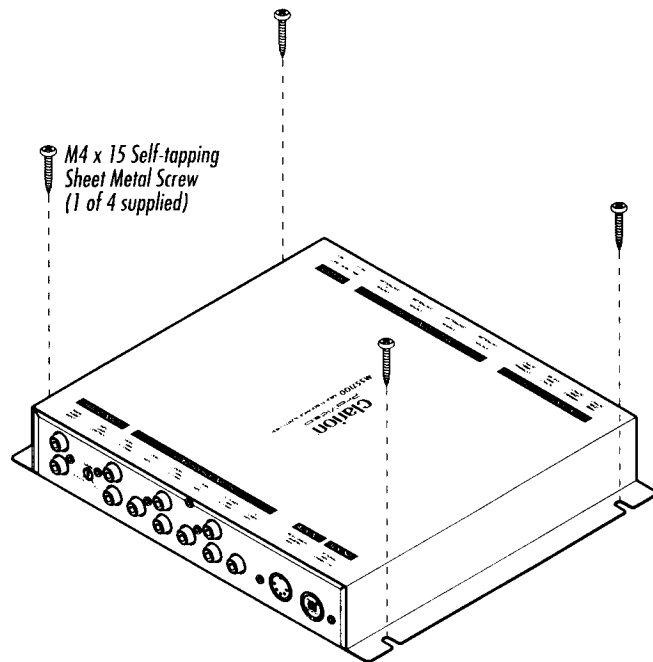

Figure 10. Installing the MSS7100.

Installing the TCS101

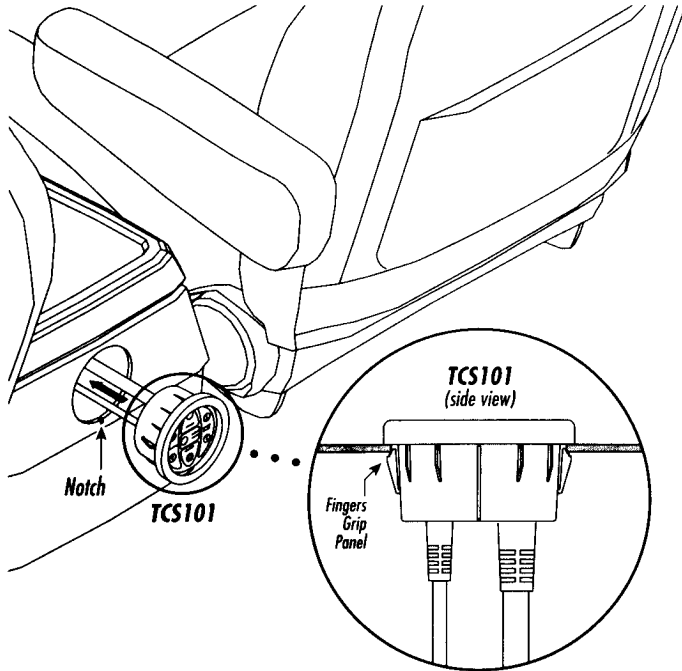

Figure 11. Installing the TCS101 in a center console.

MSS7100 Wiring for the 6-Pin Power Harness

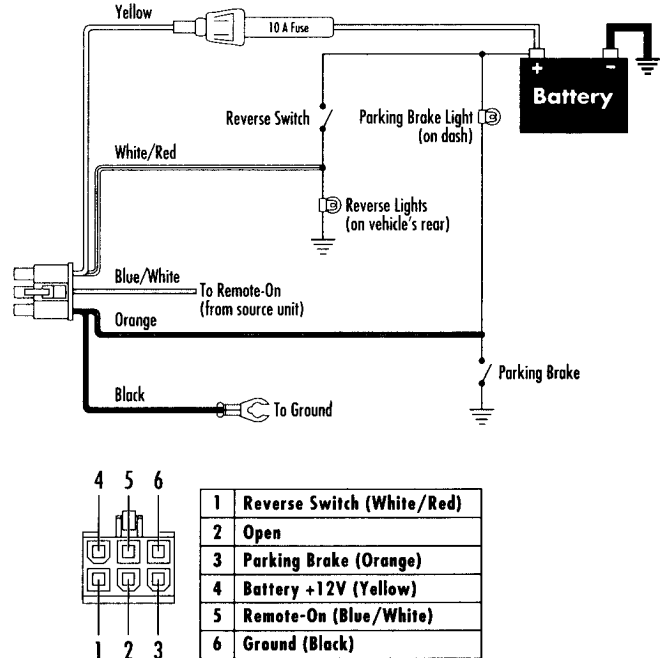

Figure 12. Wiring and pinouts for the 6-pin power harness.

INSTALLATION AND WIRING (CONTINUED)

MSS7100 Wiring for the Radio Source Input

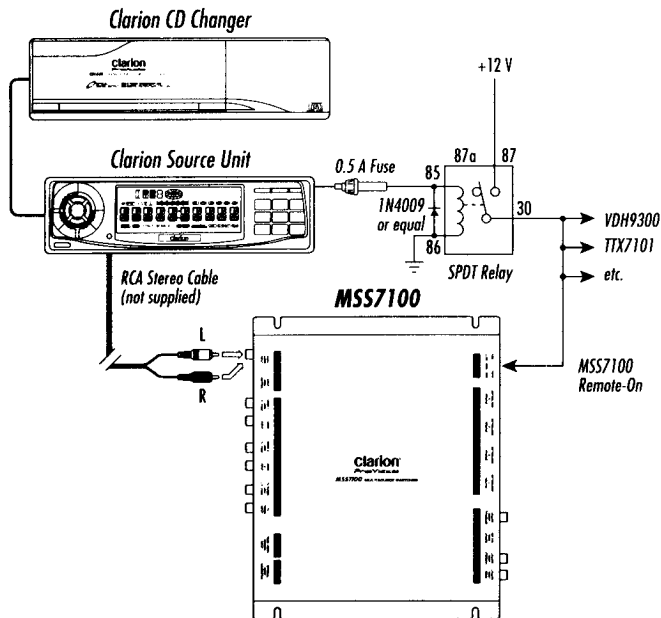

Figure 13. Wiring diagram for Radio Source Input.

MSS7100 Wiring for the Video 1 or Video 2 Input

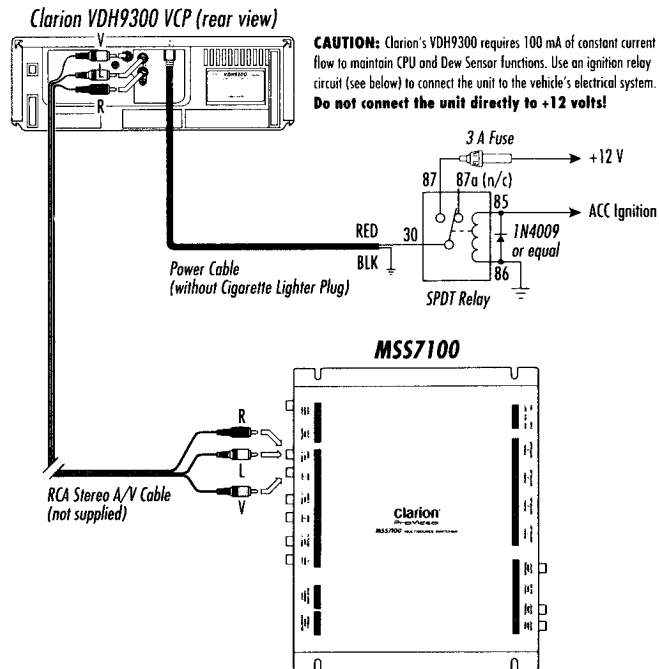

Figure 14. Wiring diagram for Video 1 or Video 2 Input.

MSS7100 Wiring for TV Tuner Input

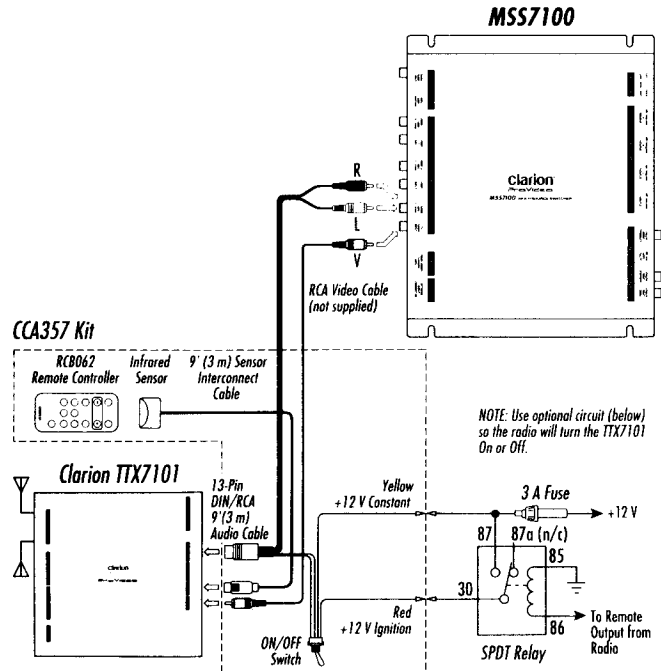

Figure 15. Wiring diagram for the TV Tuner Input.

MSS7100 Wiring for Rear Vision Input (AUX IN1)

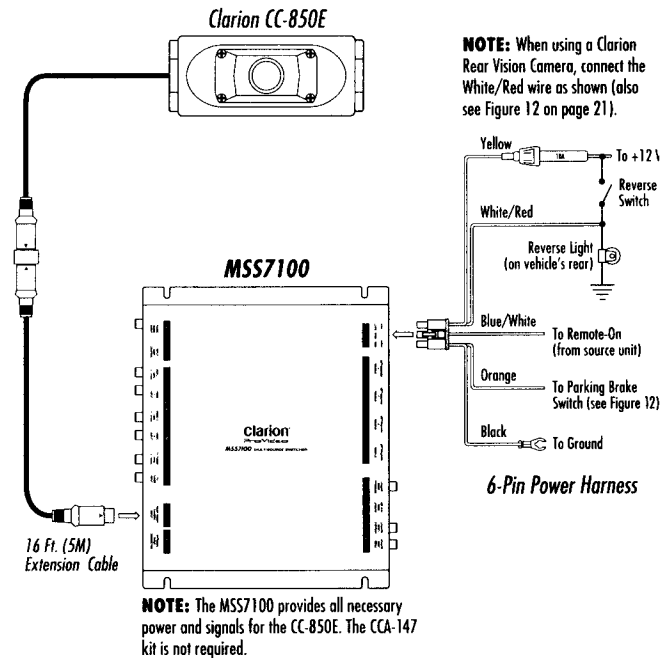
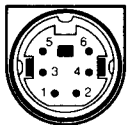

Figure 16. Wiring diagram for Rear Vision Input (AUX IN1).

INSTALLATION AND WIRING (CONTINUED)

TCS101 Connector Pinouts



**MONITOR
6-Pin Connector
(Male Pins)**

1	Video Composite Out
2	Video Ground
3	No Connection
4	+12V Monitor Power
5	+9V Monitor Remote
6	Monitor Ground

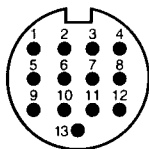

**STATION
13-Pin DIN Connector
(Male Pins)**

1	Video Composite In
2	Video Ground
3	Serial Data
4	+5V Digital Power
5	+9V Monitor Remote
6	L/R Headset Ground
7	Left + Headset
8	Right + Headset
9	+12V Monitor Power
10	+12V Monitor Power
11	Monitor Ground
12	Monitor Ground
13	GND

MSS7100 Connector Pinouts

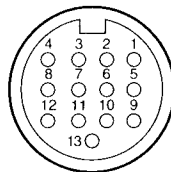

**STATION 1 ~ 4
13-Pin DIN
Connector
(Female Pins)**

Same pinouts as TCS101 STATION Connector; see Figure 17 (on the left).

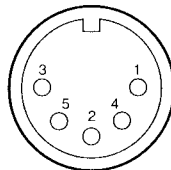

**AUX IN1
5-Pin DIN
Connector
(Female Pins)**

1	Video Signal (IN)
2	+9V Camera Remote Out (150 ma MAX)
3	+12V Heater & Shutter (300 ma MAX)
4	Camera GND
5	Video GND (IN)

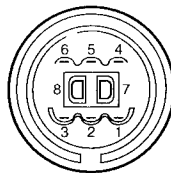

**AUX IN2
8-Pin Special
Connector**

1	SEL 3 Switching
2	SEL 2 Switching
3	No Connection
4	Video Input
5	Audio R-CH
6	Audio L-CH
7	Audio GND
8	Video GND

Figure 17. TCS101 monitor and station connector pinouts.

Figure 18. MSS7100 AUX IN1, AUX IN2, and Station 1~4 pinouts.

TROUBLESHOOTING

Symptom	Cause	Solution	Symptom	Cause	Solution
System does not work.	Fuse is blown.	Replace external fuse with the same value (see page 21).	No sound from external RCA outputs.	Station 1 has no TSC101 connected.	On the MSS7101, connect a TCS101 to the STATION 1 CONTROLLER connector.
	Power wires not connected.	Check BATTERY and GROUND wiring at switcher; check battery connections.	No video from external RCA outputs.	Power is off at Station 1.	At Station 1, press the POWER button once to turn on the unit.
	No Remote-On	Check for +12 V from Remote-On source. If voltage is low, use relay circuit (see page 21).		Station 1 has no TSC101 connected.	On the MSS7101, connect a TCS101 to the STATION 1 CONTROLLER connector.
No backlight on the TCS101 Control Station.	No Remote-On	Check for +12 V from Remote-On source. If voltage is low, use relay circuit (see page 21).		Entertainment Lock-Out (Radio Only)	Parking brake not activated; stop vehicle and set parking brake.
	Station DIN not inserted fully into 13-pin connector.	Properly connect to MSS7100; insert and lock into place.	No Rear Vision	Station 1 has no TSC101 connected.	On the MSS7101, connect a TCS101 to the STATION 1 CONTROLLER connector.
No sound from a Control Station.	Station power is off.	Press the POWER button once to turn on unit.		No Rear Vision Camera connected.	Connect a Clarion Rear Vision Camera to the 5-pin AUX IN1 connector.
	Initial power up mode; Volume is at 0 dB.	Press and hold VOLUME Up button for a desired level.		Reverse Wire not connected or no voltage.	Check for proper connection and +12 V on Reverse Wire when vehicle is in reverse gear.
No sound from external RCA outputs.	Power is off at Station 1.	At Station 1, press the POWER button once to turn on the unit.	A/V switching does not return to last-selected source.	No constant +12 V	Check yellow wire for constant +12 V battery power (see page 21).

MSS7100 SPECIFICATIONS

Audio Specifications -

Maximum Output:	2.5 V _{rms} (1 kHz at 1% THD)
Frequency Response:	20 Hz to 20 kHz, ± 2 dB at 1 kHz
S/N Ratio (A-wtd):	90 dB
Input Sensitivity:	1.0 V _{rms} (except radio inputs)
Input Impedance:	22 kohms (at 1 kHz)

Video Specifications -

Output Level:	1.0 V _{rms} \pm 0.1 V _{p-p} (at 1 MHz)
Frequency Response:	40 Hz to 4.3 MHz, ± 2 dB at 1 MHz

General Specifications -

Power Requirement:	12 V _{dc}
Fuse Rating:	10 A, fast-blow
Weight:	2.9 lb (1.3 kg)
Dimensions (w x h x d):	9.84 x 8.03 x 1.57 in. (250 x 204 x 40 mm)

TCS101 SPECIFICATIONS

Headphone Output:	100 mW (1 kHz at 10% THD)
Dimensions (w x d):	2.48 x 1.32 in. (63 x 33.5 mm)
Mounting Depth:	1 in. (25.5 mm): behind panel
Mounting Hole Diam.:	2.25 in. (57 mm)

Due to Clarion's ongoing research and development, the product specifications and appearances listed in this manual are subject to change without prior notice.

FCC STATEMENT

This equipment has been tested and found to comply with the limits for a Class B digital device, pursuant to Part 16 of the FCC Rules. These limits are designed to provide reasonable protection against harmful interference in a residential installation. This equipment generates, uses, and can radiate radio frequency energy and, if not installed and used in accordance with the instructions, may cause harmful interference to radio communications. However, there is no guarantee that interference will not occur in a particular installation.

If this equipment does cause harmful interference to radio or television reception, which can be verified by turning the unit off and on, the user is encouraged to consult the dealer or an experienced radio/television technician for help.

TCS101 MOUNTING TEMPLATE

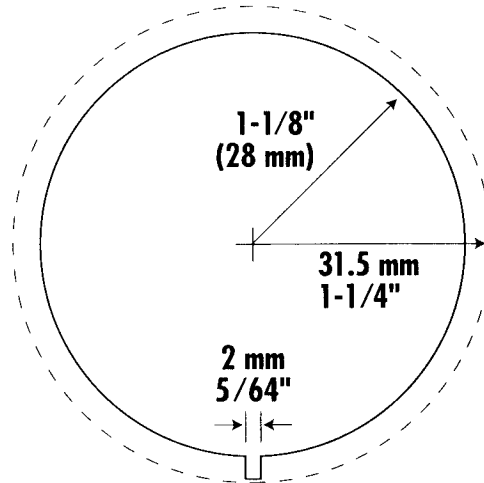

Free Manuals Download Website

<http://myh66.com>

<http://usermanuals.us>

<http://www.somanuals.com>

<http://www.4manuals.cc>

<http://www.manual-lib.com>

<http://www.404manual.com>

<http://www.luxmanual.com>

<http://aubethermostatmanual.com>

Golf course search by state

<http://golfingnear.com>

Email search by domain

<http://emailbydomain.com>

Auto manuals search

<http://auto.somanuals.com>

TV manuals search

<http://tv.somanuals.com>