



ClearSounds®

Hear how good life can be



Operating Manual

A1600 DECT 6.0

Amplified Cordless Freedom Deluxe Phone™

TABLE OF CONTENTS

PRIOR TO USE

- Pg. 6 Congratulations
- Pg. 6-8..... Important Safety Instructions
- Pg. 9-13..... Location of Controls
- Pg. 13-16 Key Descriptions
- Pg. 16-17 Handset LCD Icon Descriptions
- Pg. 17-20 Installation Steps
- Pg. 20 Hearing Aid and Cochlear Implant Users

BASE SPEAKERPHONE OPERATION

MENU NAVIGATION

- Pg. 22-23 Menu Map

LCD DISPLAY

- Pg. 23-24 Language
- Pg. 24 Set Contrast
- Pg. 25 Set Date & Time
- Pg. 26-27 LCD Descriptions
- Pg. 27-28 Reviewing Voice Mail

BASE SETTINGS

- Pg. 28-29 Ringer Setting
- Pg. 29 Keypad Tones Setting
- Pg. 30 Dialing Mode
- Pg. 30-31 Call Waiting/Flash
- Pg. 31 Auto On Hook
- Pg. 32-33 Talking Set-Up

BASIC PHONE FUNCTIONS

- Pg. 33-34 Hands-Free Headset Jack and Audio Jack
- Pg. 34-35 Amplification
- Pg. 36 Speakerphone
- Pg. 36 Answer a Call
- Pg. 36-37 Make a Call

- Pg. 37-38 One-Touch Memory
- Pg. 39-40 Mute, Hold, Redial

CALLER ID (CID)

- Pg. 41 Receiving & Storing Caller ID Records
- Pg. 41 Talking Caller ID
- Pg. 42-43 Caller ID on Call Waiting
- Pg. 42 Review Caller ID
- Pg. 42 Dial from Caller ID
- Pg. 42-43 Delete Caller ID
- Pg. 43 Store Caller ID

PHONEBOOK

- Pg. 44 Add Phonebook Entries
- Pg. 45 Using a Pause
- Pg. 45 View Phonebook Entries
- Pg. 45 Dial a Phonebook Number
- Pg. 45-46 Phonebook Entry, Edit, Erase, Record Voice

HANDSET OPERATION

MENU NAVIGATION

- Pg. 47-48 Menu Map

HANDSET SETUP

- Pg. 49 Handset Registration
- Pg. 50 Handset Name
- Pg. 50 Delete/Terminate Handset
- Pg. 51 Base Selection
- Pg. 51 Handset Reset
- Pg. 52 Out of Range Alarm
- Pg. 52 Dialing Mode
- Pg. 53 Call Waiting/Flash
- Pg. 54 Change PIN

LCD DISPLAY

- Pg. 54 Set Contrast
- Pg. 55 Set Date & Time
- Pg. 56 LCD Descriptions
- Pg. 56 Reviewing Voice Mail

HANDSET SETTINGS

- Pg. 56-57 Ringer Setting
- Pg. 58 Auto Answer
- Pg. 58-59 Keypad Tones Setting
- Pg. 59 Language Setting
- Pg. 60 Talking Set-up

BASIC PHONE FUNCTIONS

- Pg. 61-62 Amplification
- Pg. 62-63 Speakerphone
- Pg. 63 Answer a Call
- Pg. 63-64 Make a Call
- Pg. 64-65 One-Touch Memory
- Pg. 65-66 Mute, Redial

CALLER ID (CID)

- Pg. 67 Receiving & Storing Caller ID Records
- Pg. 68 Caller ID on Call Waiting
- Pg. 69 Review Caller ID
- Pg. 69 Dial from Caller ID
- Pg. 69-70 Delete Caller ID
- Pg. 70 Store Caller ID

PHONEBOOK

- Pg. 72 Add Phonebook Entries
- Pg. 72 Using a Pause
- Pg. 72 View Phonebook Entries
- Pg. 73 Dial a Phonebook Number
- Pg. 73-74 Phonebook Entry, Edit, Erase, Record Voice

ADDITIONAL HANDSET FUNCTIONS

- Pg. 75 Paging
- Pg. 75 Key Lock
- Pg. 75-76 Alarm
- Pg. 76 Torch

PHONE ANSWERING MACHINE (TAM)

- Pg. 77 Turn On/Off
- Pg. 78-86 TAM Settings
- Pg. 86 Record a Memo
- Pg. 87 Security ID/PIN & Remote Access

TROUBLESHOOTING GUIDE

- Pg. 88-90

TECHNICAL SPECIFICATIONS

- Pg. 91

REGULATORY COMPLIANCE

- Important FCC Information for Customers
- Pg. 92-93

INDUSTRY CANADA

- Pg. 94

WARRANTY POLICY

- Pg. 95-96

PRIOR TO USE

Congratulations on your purchase of the A1600 phone from ClearSounds Communications®. Please read this User Manual carefully in order to get the best use out of your new phone. This phone is designed for individuals with mild to severe hearing loss. Keep this manual near the phone for easy reference.

Please visit our website at www.clearsounds.com to register your product, download additional manuals and review troubleshooting tips.

Be sure to save your sales receipt as your proof of purchase should you need warranty service. The serial number for this product is located on the underside of the base.

Warranty Service – This product is designed to provide years of quality service. However, if there is a malfunction and the troubleshooting recommendations on pages 88-90 do not resolve the problem, follow the warranty procedure on pages 95-96 .

IMPORTANT SAFETY INSTRUCTIONS

Read and understand the Installation Guide and User Manual. When using your phone equipment, basic safety precautions should always be followed to reduce the risk of fire, electric shock and injury to person, including the following:

WARNING: The A1600 phone is capable of amplifying sounds to a loud volume. It is important to instruct all potential users of its proper operation. It is advised to adjust the volume control to the minimum level (Low) when not in use and alert other users that hearing damage can potentially result from misuse.

WARNING: Use only the power supply indicated in the User's Manual.

WARNING: To avoid the possibility of electrical shock, do not

use this product near water (For example, near a bathtub, wash basin, kitchen sink or laundry tub, in a wet basement or near a swimming pool) while in the bathtub or shower or when you are wet. If the phone becomes submerged in water, do not attempt to retrieve it until after you have unplugged the AC adapter from the electrical outlet and the line cord from the modular wall jack. Do not plug the phone back in until it has dried completely.

WARNING: Avoid using the phone during electrical storms. There may be a remote risk of electric shock from lightning. If the electrical storm is present in your immediate area, possibility of electrical shock exists.

WARNING: Do not use the phone if you suspect a gas leak in the area. The phone's electrical contact could create a spark, which could ignite any heavy concentration of leaking gas.

WARNING: When cleaning, unplug the phone first, and then use a damp cloth to wipe. Do not use liquid cleaners or aerosol cleaners on the phone.

WARNING: No phone should ever be placed near an open radiator or heating register.

WARNING: Occasionally a power surge can occur on electrical lines without warning. With any electrical device that you plug into an outlet, it is suggested you use a surge protector. A surge protector will prevent power surges from damaging your phone. Surge protectors are simple devices available at your local hardware store.

WARNING: Do not overload wall outlets or extension cords as this can increase the risk of fire or electrical shock.

WARNING: Never push any object through the slots in the phone. They can touch dangerous voltage points or short out parts that could result in risk of fire or electrical shock.

WARNING: Do not cover slots and opening on the units, they are needed for ventilation and protection against overheating.

WARNING: Stop using the phone if dropped or if it becomes damaged.

WARNING: Ring volume is very loud and can damage your hearing. Never put your ear close to the ringer.

WARNING: Pay attention to the polarity of the batteries

and insert the rechargeable batteries in accordance with the polarity symbols. Use only batteries identified as acceptable and never use alkaline batteries, which can cause personal injury as well as damage to the unit.

Hearing Aid Compatibility (HAC)

This phone meets the FCC standards for Hearing Aid Compatibility.

IMPORTANT: YOUR RECEIPT IS PART OF YOUR WARRANTY AND MUST BE RETAINED AND PRODUCED IN THE EVENT OF A WARRANTY CLAIM.

PLEASE SAVE THESE INSTRUCTIONS

LOCATION OF CONTROLS

HANDSET

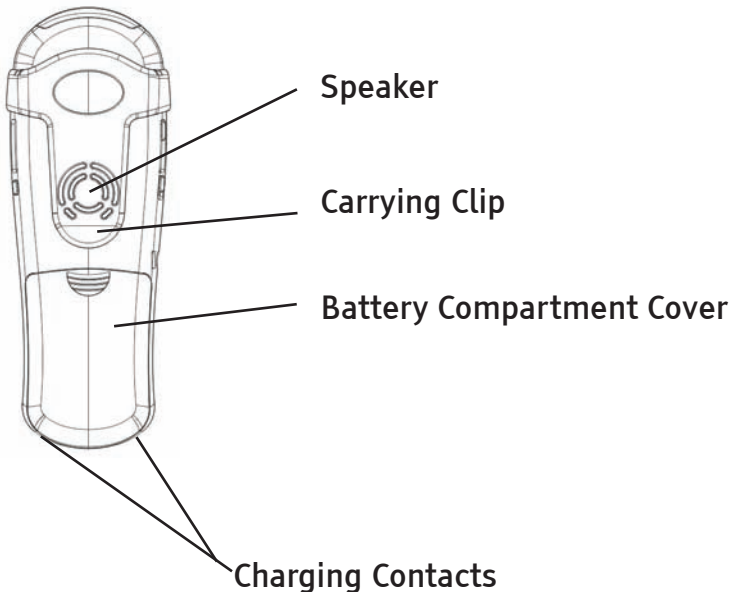
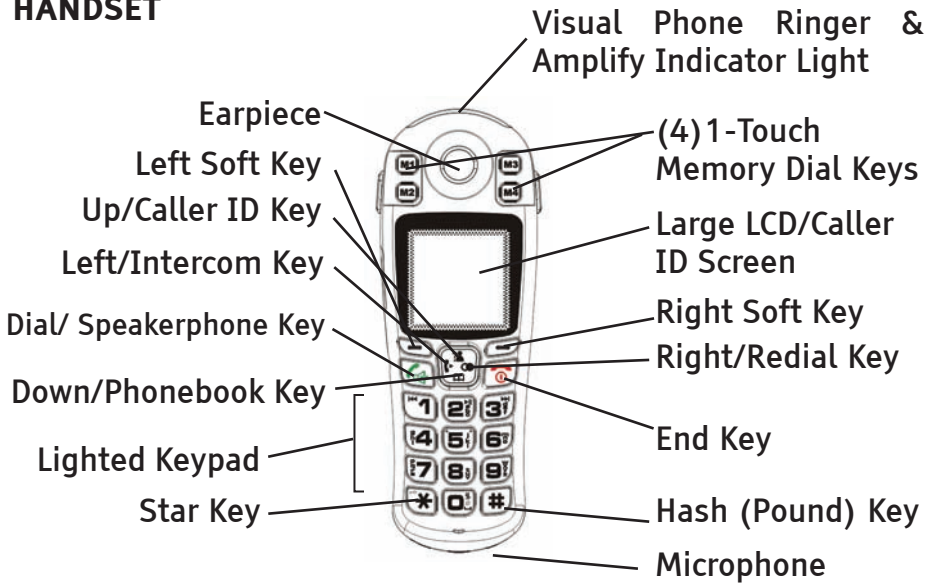

LEFT SIDE OF HANDSET

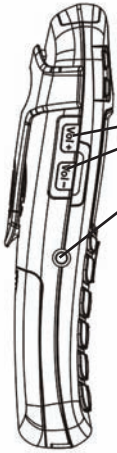

Vol+/Vol- Key (Handset Volume)

Phone (2.5mm) Headset / Neckloop Jack

RIGHT SIDE OF HANDSET



Tone Key - Handset Tone Control

AMP Key - Amplify Activation Key



Right Soft Key

Play/Stop Key

Next Key

Previous Key

Delete Key

MEMO Key

Page Key

Call Waiting Key

Headset Key

Visual Phone Ringer

Message Waiting/New Call

In Use LED Indicator

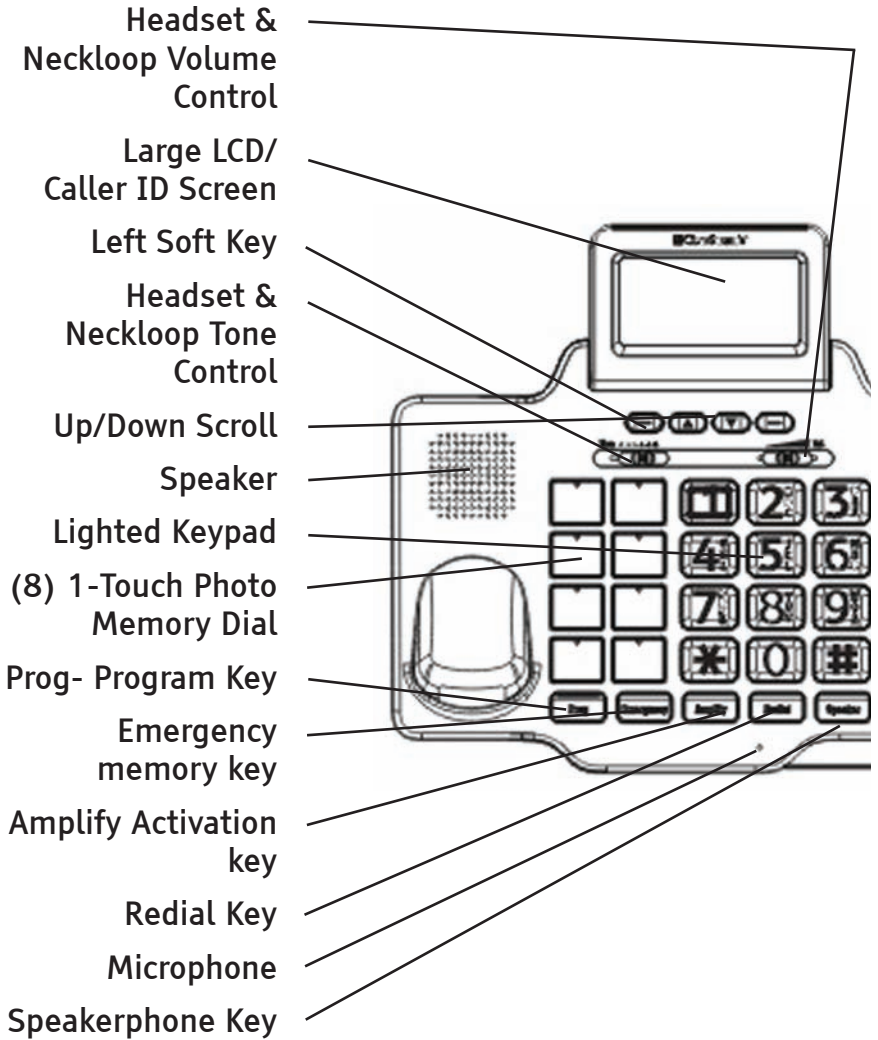

BACK SIDE OF BASE

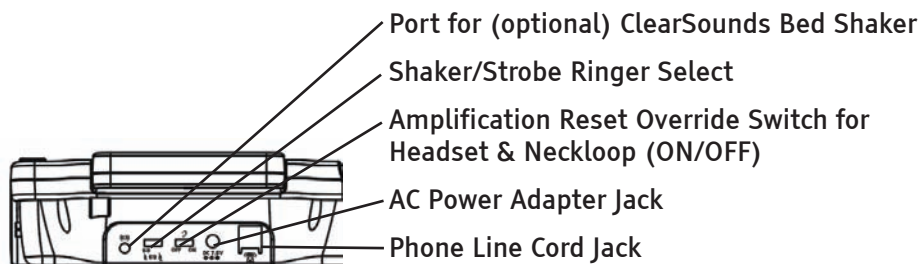

LEFT SIDE OF BASE

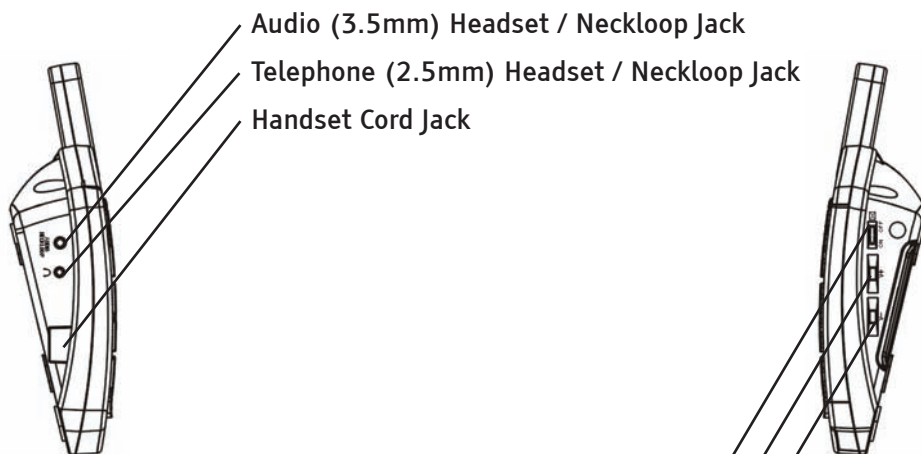

RIGHT SIDE OF BASE

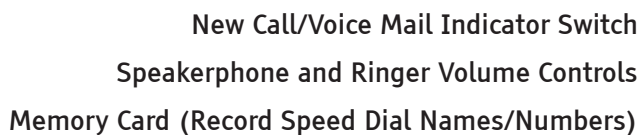

UNDERSIDE OF BASE

Back Light ON/OFF Switch

Empty Compartment

Memory Card

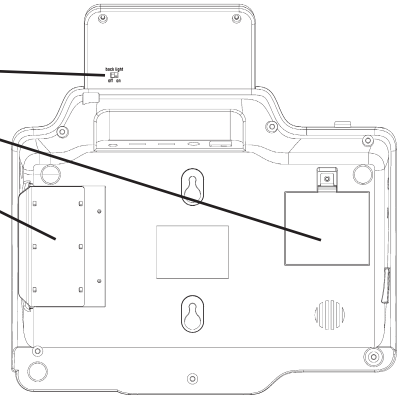

KEY DESCRIPTIONS

HANDSET



Dial Key

Make/Answer a call

Activates the speakerphone if pressed during a call, as described on page 62.



End Key

Long press to activate power on/off, as described on page 58.



Navigation Key:

Up scroll for lists and menu options

Increase the earpiece/speakerphone volume during a call

Enter the Caller ID (CID) book, as described on page 69.



Down scroll for lists and menu options

Decrease the earpiece/speakerphone volume during a call

Enter the Phonebook, as described on page 72.



Enter the redial list, as described on page 66.

Insert a pause when pre-dialing a number or storing a phonebook entry, as described on page 72.



Soft Keys

Two soft keys are used to select functions displayed directly above each of the soft keys (on the bottom line of the display). Functions displayed above the soft key will change as you move through the menu.



One-touch memories

Store up to 4 numbers for one-touch memory dialing, as described on page 65.



Star Key

Press and hold to turn on/off keypad lock function, as described on page 75.



O Key

Press and hold to activate the shaker and visual ringer function, as described on page 57.

BASE



Program Key

Use to store numbers.



Emergency Key

Use for emergency speed dialing, as described on page 37.



Amplify Key

Press to add an extra level of amplification & tone to headset or neckloop, as described on page 35.



Redial Key

Last number redial, as described on page . Insert a pause when pre-dialing a number, as described on page 37.



Speaker Key

Make/Answer/End a call

Activates the speakerphone if pressed during a call, as described on page 36.



Soft Keys

Two soft keys are used to select functions displayed directly above each of the soft keys (on the bottom line of the display). Functions displayed above the soft key will change as you move through the menu.



Up/Down Keys

Scroll for menu options. Enter the CID book, as described on page 42.



Volume Up/Down Key

Use to adjust the volume of the ringer, talking dialing and talking Caller ID.



Volume & Tone Keys

Use to adjust the volume and tone of the headset or neckloop, as described on page 34.



Page Key

Use to register handset(s), as described on page 75.
Use to help locate the handset if you can't find it, as described on page 75.



Call Waiting Key

To disconnect a call and re-establish dial tone or to switch over to another caller if you use call waiting, as described on page 41.



Headset Key

Use for hands-free calls with a 2.5mm hands-free headset or neckloop, as described on page 33.

BASE ANSWERING MACHINE



Play/Stop Key

Press to start or stop the Message or Memo playing



Skip Key

Press to play the next message



Repeat Key

Press once to play the current message
Press twice to play the previous message



Delete Key

While playing an incoming message, press and hold this key to delete the current message.

When the answering machine is ON, press and hold this key to delete all of the messages.



Memo Key

Press and hold this key to record a memo (it will be stored as a new message)

HANDSET LCD ICON DESCRIPTIONS



New Call (top center)

Indicates you have missed one or more calls



Message Waiting (top center)

Indicates you have one or more voice mail messages.



Off Hook (top right)

Indicates the line is engaged



Hands-Free (top right)

Indicates the hands-free function (handset speakerphone) is engaged, as described on page 62.

**Battery (top right)**

Indicates battery charge level

**Shaker (top center)**

Indicates the shaker and visual ringer are enabled, as described on page 57.

**Signal (top left)**

Indicates the current signal strength. If the handset is too far from the base, this icon will blink on the LCD.

**Alarm (top center)**

Appears when you set an alarm to ring at a specific time, as described on page 75.

**Keypad Lock (top left)**

Appears when the keypad is locked, as described on page 75.

**Incoming Message (center right)**

Appears when you have new answering machine message(s)

■ INSTALLATION STEPS

Installation of Your **ClearSounds® A1600 DECT 6.0 Amplified Cordless Freedom Deluxe Phone™** is easy. There are some basic steps you need to take when you set-up your phone for the first time.

If at any time you have questions about your phone after reading this manual, please contact the ClearSounds® Customer Service Department at 1-800-965-9043.

■ PARTS CHECKLIST

Check the contents of the box - The A16000 should contain:

1. Phone base
2. Cordless Handset
3. Batteries
4. Phone Line Cords
5. AC Adapter
6. Carrying Clip
7. User Manual



■ PHONE INSTALLATION

The phone should be located in an area where it is easy to see the visual display and lighted ringer. Choose an area near a phone wall jack (RJ11C) and power outlet. To avoid potential interference, the phone should not be located near electronic equipment, such as personal computers, television or microwave ovens.

Begin by removing the clear plastic Caller ID protective tab from the handset and the base. This film tab is only for display and to protect your Caller ID displays during shipping.

Connecting Lines

1. Connect one end of the 6 ft phone cord to the line jack on the back of the base and connect the other end to a modular phone jack.
2. Plug the AC power adapter into the jack on the back of the base, then plug the AC adapter into a standard electrical outlet or surge protector.

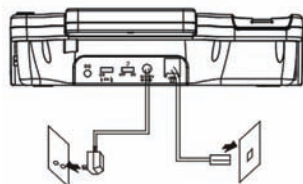

to AC outlet / to phone jack

Note: The adapter is required for the phone to work.

Installing Batteries

Three AAA re-chargeable Ni-MH batteries come with your phone. You must install the handset batteries before using your phone.

1. Remove the battery compartment cover by sliding it downwards.
2. Insert the new batteries. Be sure to observe battery polarity as imprinted on the inside of the compartment.
3. Replace the battery compartment cover by sliding upward until it clicks into place

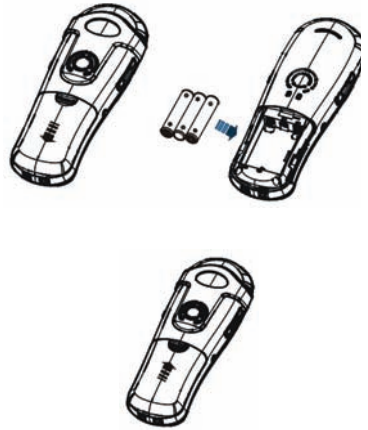

Note: The batteries need to be replaced if they do not recover their full storage capacity after recharging. Check the battery icon on the LCD to see the battery charge level.

When replacing the batteries, always use good quality Ni-MH AAA re-chargeable batteries.

Charging the Handset

1. Place the handset into the base. The LCD screen will light up and you will hear a beep to indicate charging has begun.
2. **Important: Before initial operation, you should fully charge the handset for at least 15 hours.**
3. After the batteries are fully charged, check for dial tone by pressing the dial key on the handset.



When battery power is very low and you place the handset on the base, the display will show **Charging...**. Check the battery icon on the LCD to see the battery charge level.

Using the Handset Carrying Clip

You may choose to use the optional belt clip provided with your handset.

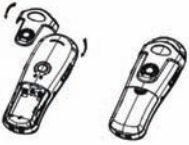

1. To attach, slide the belt clip down onto the grooves. Press the tabs on the belt clip into the slots to attach.
2. To remove, insert a screwdriver along the edge of one of its "arms" and release the clip and then lift it off.

■ Using your Phone with Hearing Aids and Cochlear Implants

Your phone can be used with hearing aids and cochlear implants equipped with a telecoil (T-coil). Adjust your hearing aid "T-switch" to the "T" position. Make sure to hold the handset close to your T-coil.

MENU NAVIGATION

SETTING UP YOUR BASE SPEAKERPHONE





■ MENU

Screen Navigation



If you press  under the word **Back** on the screen from any menu, the phone returns to the previous screen. The phone will automatically return to the main screen from any menu if no key is pressed for 20 seconds.

"Standby" can mean that you are at the main screen or can also mean that you are not on a live call and do not have dial tone engaged.



To Access a MENU Option

1. Press  under the word **Menu** on the screen to display the main menu list.
2. To scroll through menu options, press  or  repeatedly. The menu item that is currently selected will be highlighted.
3. When the desired menu item is highlighted, press  under the word **Select** or **Save**.
4. Repeat if necessary.

To Access a MENU Option

Press  under the word **Back** or **Exit** on the screen from any menu and the phone returns to the previous screen. Continue to press  under the word **Back** or **Exit** to return to the main screen. The phone will automatically return to the main screen from any menu if no key is pressed for 20 seconds.

To Exit from any MENU

Press  under the word **Back** or **Exit** on the screen from any menu and the phone returns to the previous screen. Continue to press  under the word **Back** or **Exit** to return to the main screen. The phone will automatically return to the main screen from any menu if no key is pressed for 20 seconds.

MENU MAP – this identifies how the menu is displayed for navigation

Main Menu	Submenu I	Submenu II
PhoneBook (PhoneBk) (p. 43)	Options (p. 45)	Play Voice Record Voice Erase Voice Edit Erase
Set Display (p. 23)	Set Language (p. 23)	
	Set Contrast (p. 24)	Level 1-7
	Dim: X--->x (p. 24)	On or Off
	Hour Format (p. 25)	12 hour clock or 24 hour clock
	Date Format (p. 25)	MM/DD or DD/MM
Set Phone (p. 28)	Set Ring (p. 28)	Ringer Volume Ringer Tone Keypad Tones ON or OFF
	Call Waiting (p. 31)	On or OFF
	Set Flash (p. 30)	100ms, 300ms, or 600ms
	Dialing Mode (p. 30)	Tone or Pulse
	AUTO ON HOOK (p. 31)	ON or OFF
Date and Time (p. 25)		
Set Talk (p. 32)	DIALING TALKING (p. 32)	ON or OFF
	CID TALKING (p. 32)	ON or OFF
	REVIEW TALKING(p.32)	ON or OFF
	VOICE PROMPT (p. 23)	

Main Menu	Submenu I	Submenu II
TAM setup (p. 77)	TAM ON/OFF (p. 77)	
	Outgoing Msg (p. 80)	Play OGM Record OGM Change OGM Erase OGM
	Ring Number (p.78) Security ID (p. 87)	2,4,6,8, toll saver
	ICM Voice Slow (p. 86)	ON or OFF







LCD DISPLAY

Reminder: Press  under the word **Back** or **Exit** from any menu to return to the previous screen. Otherwise, after 20 seconds, the phone will automatically return to the main screen from any menu if no key is pressed.

LCD SETTINGS

Language Setting

The phone base supports up to 4 predefined languages: English, French, Spanish, German. Changing the language will cause the menu to be displayed in the new language. To select a language:

1. Press  under the word **Menu** on the screen to display the main menu list.
2. Press  or  to scroll to **Set Display** and then press  under the word **Select**.
3. Press  under the word **Select** to select Language.
4. The languages will be displayed. Press  or  to scroll through the language options. Each language will be displayed in its own native translation.

5. Select the desired language and then press **⊖** under the word **Select**.

To go back to the English menu if you can't read the current language displayed:

1. Press the right soft key (**⊖**).
2. Press the left soft key (**⊖**).
3. Press the left soft key (**⊖**).
4. Press **▲** or **▼** to find "English" in the list of languages.
5. Press the left soft key (**⊖**) to save the setting.

Contrast Setting

1. Press **⊖** under the word **Menu** on the screen to display the main menu list.
2. Press **⊖** under the word **Select** to access **Set Display**.
3. Press **▼** to scroll to **Set Contrast** and then press **⊖** under the word **Select**.
4. Press **▲** or **▼** repeatedly to choose from the 8 available contrast levels and then press **⊖** under the word **Select**.

Switch to Smaller Font

If you select ON, when you pre-dial a number and the number exceeds 8 digits, the font will be switched to a smaller size automatically.

1. Press **⊖** under the word **Menu** on the screen to display the main menu list.
2. Press **⊖** under the word **Select** to access **Set Display**.
3. Press **▼** to scroll to **Dim:X--->x** and then press **⊖** under the word **Select**.
4. Press **▲** or **▼** to choose between ON/OFF and then press under the word **Select**.

If you have Caller ID service, the date and hour will be automatically set when you receive your first call. If you currently do not have Caller ID service through your phone company, please follow the directions below. You can change the format of the time and date to your preference.

Hour Format Setting

1. Press **⊖** under the word **Menu** on the screen to display the main menu list.
2. Press **⊖** under the word **Select** to access **Set Display**.
3. Press **▲** or **▼** to scroll to **Hour Format** and then press **⊖** under the word **Select**.
4. Press **▲** or **▼** to choose between 12 hour clock and 24 hour clock and then press **⊖** under the word **Select**.

Date Format Setting

1. Press **⊖** under the word **Menu** on the screen to display the main menu list.
2. Press **⊖** under the word **Select** to access **Set Display**.
3. Press **▲** or **▼** to scroll to **Date Format** and then press **⊖** under the word **Select**.
4. Press **▲** or **▼** to choose between **MM/DD** and **DD/MM** and then press **⊖** under the word **Select**.

Set Date & Time

1. Press **⊖** under the word **Menu** on the screen to display the main menu list.
2. Press **▲** or **▼** to scroll to **Date and Time** and then press **⊖** under the word **Select**.
3. Enter the current time using the numeric keypad and use the **★** to select AM/PM and then press **⊖** under the word **Save**.
4. Enter the current date using the numeric keypad and then press **⊖** under the word **Save**.
5. Enter the current year using the numeric keypad and then press **⊖** under the word **Save**.

Note: If you select **12 - Hour clock**, AM/PM will appear at the right of the time in standby mode. If you select **12 – Hour**, you will still need to enter the time in the **24 – Hour** format.

■ LCD Descriptions

Your A1600 base has a large LCD screen that provides useful information. Your screen has a backlight that automatically switches off after 15 seconds of inactivity. You may permanently turn ON the LCD backlight by using the switch on the back of the display and select the ON position.

In standby mode, the large LCD display will show as below:



IMPORTANT: The word **TOTAL** refers to the total number of **available** Caller ID records

The word **NEW** refers to the total number of **new** Caller ID records that have not yet been reviewed

The word **MSG** refers to the total number of **new** messages received.

Notification for new messages will be displayed before new Caller ID records. Once you have listened to your new messages, the LCD will next display the new Caller ID records.



If you forget to connect the phone line cord, “**No line**” will show on the screen.



When you press the **Menu** soft key, the display will show the main menu. Use the ▲ or ▼ key to scroll through the menu and select the desired one and then press **Select** to confirm.

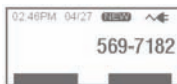

When a new call comes in, the screen will display the caller's phone number and/or name (provided that you subscribe to this service through your local telephone provider).



Shows the total and new calls to be reviewed. In the example, there are 16 calls in total, which includes 12 new calls.



Shows the total of new messages. In the example, there are 2 new messages and the display will show **MSG 02**.

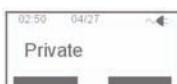

If the caller has exercised the option to prevent his name and number from being sent, **Private** will show on the display.

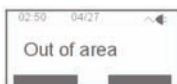

This message will display when someone calls from another country, an area where the telephone company is not offering the caller identification services or is not yet providing number delivery to your area.

■ Reviewing Voice Mail Messages

You must subscribe to Voice Mail from your phone service provider to use this feature. **NOTE: You are not able to utilize voice mail and the built-in answering machine at the same time.**

When a voice mail message is left, the screen will display "New voice mail" and the message will be saved as a call. If you have new messages, you will hear a stutter dial tone when you pick up the handset. The phone has a voice mail message indicator light, which will blink when you have new voice mail messages and will continue to flash until the message has been retrieved. Follow the steps provided from your phone provider to listen to your message(s).

Note: You may permanently turn off the red flashing visual indicator for both message waiting and new calls by simply setting the indicator to the **OFF** position (this switch is located on the right side of the telephone).













PHONE BASE SETTINGS

Reminder: Press  under the word **Back** from any menu to return to the previous screen. Otherwise, after 20 seconds, the phone will automatically return to the main screen from any menu if no key is pressed.

■ Ringer Setting

Audible Ringer

You can adjust the ringer of your phone and you can also select a ring tone.

1. Press  under the word **Menu** on the screen to display the main menu list.
2. Press  to scroll to **Set Phone** and then press  under the word **Select**.
3. Press  under the word **Select** to access **Set Ring**.
4. Press  under the word **Select** to access **Ringer Volume**.
5. Press  or  to select the volume (volume 1-volume 6, or OFF). When adjusting the Volume, the base plays the selected loudness.
6. Press  under the word **Select** to confirm.
7. To adjust the ring tone, press  to scroll to **Ringer Tone**.
8. Press  or  to select the desired ring tone from the 10 melodies. When adjusting the Melody, the handset plays the selected melody.
9. Press  under the word **Select**.

In standby mode, you can adjust the ringer volume by using the Volume Control **V-** or **V+** on the right side of the phone. The display will show the current level. For example: **Volume 3**. You will also hear the audible ringer at each level you select.











Visual Ringer & Shaker Option

Your phone is equipped with a bright LED light that can flash a very bright light when the phone rings. If you have selected the LED light to be ON, it will flash on all volume levels.

Your phone is equipped with a 3.5mm vibrating alert jack for an optional bed shaker (purchased separately) to alert you when the phone is ringing. Simply plug it into the shaker jack and place it between your mattress and box spring or under the cushion of a chair. When the phone rings, the pad will vibrate with each ring of the phone.

■ Keypad Tones Setting









Your ClearSounds® A1600 comes from the factory preset for menu Keypad Tones ON. This refers to having an audible tone when navigating the menu to verify a selection. To change this setting:

1. Press  under the word **Menu** on the screen to display the main menu list.
2. Press  to scroll to **Set Phone** and then press  under the word **Select**.
3. Press  under the word **Select** again to select **Set Ring**.
4. Press  or  to scroll to **Keypad Tones** and then press  under the word **Select**.
5. Press  or  to choose between ON/OFF and then press  under the word **Select**.

■ Dialing Mode Setting









Your ClearSounds® A1600 comes from the factory preset for touch-tone service. Should you need to change this setting based on the type of phone service you have, use **Tone** for touch-tone service or **Pulse** for rotary dialing.

NOTE: If you are not sure which dialing mode to select, please contact your local phone service provider. To change this setting:

1. Press  under the word **Menu** on the screen to display the main menu list.
2. Press  to scroll to **Set Phone** and then press  under the word **Select**.
3. Press  or  to scroll to **Dialing Mode** and then press  under the word **Select**.
4. Press  or  to select **Tone** or **Pulse** and then press the  under the word **Save**.

■ Call Waiting (Flash)

Your ClearSounds® A1600 comes from the factory preset for Flash Time to 600ms. Flash timing is the signaling process that tells the phone system when a phone is on hook or off hook. The United States uses a 600ms timing sequence. The European Union uses a 300ms timing sequence. You can choose from 100ms, 300ms or 600ms. To change this setting:

1. Press  under the word **Menu** on the screen to display the main menu list.
2. Press  to scroll to **Set Phone** and then press  under the word **Select**.
3. Press  or  to scroll to **Set Flash** and then press  under the word **Select**.
4. The display shows the current setting. Press  or  to choose from 100ms, 300ms, or 600ms and then press  under the word **Select**.

Your ClearSounds® A1600 comes from the factory preset for Caller ID on Call Waiting ON. To change this setting:

1. Press **⊖** under the word **Menu** on the screen to display the main menu list.
2. Press **▼** to scroll to **Set Phone** and then press **⊖** under the word **Select**.
3. Press **▼** to scroll to **Call Waiting** and then press **⊖** under the word **Select**.
4. Press **▲** or **▼** to choose between ON/OFF to activate/deactivate the call waiting function and then press **⊖** under the word **Select**.

Note: If you subscribe to Call Waiting on Caller ID, you will receive Caller ID information (if available) on Call Waiting calls (see page 41).

If you subscribe to Call Waiting service from your local phone provider, during a phone call you will hear a beep to indicate another call is waiting on the line.

1. To connect to the waiting call, press the **Call Waiting** key, and your original call is put on hold. The display will show **F**.
2. To switch between the two calls, press the **Call Waiting** key.









■ Auto On Hook

Your ClearSounds® A1600 comes from the factory preset for Auto On Hook set to OFF. This feature can automatically disconnect the line after 15-30 minutes if the phone is left off the hook. This will restore your line to be able to receive another call even if the call is not disconnected. To change this setting:

1. Press **⊖** under the word **Menu** on the screen to display the main menu list.
2. Press **▼** to scroll to **Set Phone** and then press **⊖** under the word **Select**.
3. Press **▲** or **▼** to scroll to **AUTO ON HOOK** and then press **⊖** under the word **Select**.
4. Press **▲** or **▼** to select On or Off and then press **⊖** under the word **Save**.









■ Talking Dialing Setting

Your ClearSounds® A1600 comes from the factory preset for Talking Dialing Mode set to OFF. This feature allows you to pre-dial the number you wish to call and you will hear the number announced as you dial as well as display the numbers on the LCD. To change this setting:

1. Press  under the word **Menu** on the screen to display the main menu list.
2. Press  or  to scroll to **Set Talk** and then press  under the word **Select**.
3. Press  under the word **Select** to access **DIALING TALKING**.
4. Press  or  to choose between ON/OFF to activate/deactivate the talking dialing function and then press  under the word **Select**.

■ Talking Caller ID Setting

Your ClearSounds® A1600 comes from the factory preset for Talking Caller ID Mode set to OFF and will announce the caller's number between rings. To change this setting:

1. Press  under the word **Menu** on the screen to display the main menu list.
2. Press  or  to scroll to **Set Talk** and then press  under the word **Select**.
3. Press  to scroll to **CID TALKING** and then press  under the word **Select**.
4. Press  or  to select ON/OFF to activate/deactivate the dialing function and then press  under the word **Select**.

■ Talking Review Function (Caller ID, Phonebook & Redial)

Your ClearSounds® A1600 comes from the factory preset for Talking Review set to OFF

- When reviewing CID records, the phone will announce the number.
- When reviewing phonebook entries, the phone will announce the number or recorded message.
- When using the Redial function, the phone will announce the number or recorded message.

To change this setting:

1. Press **⊖** under the word **Menu** on the screen to display the main menu list.
2. Press **▲** or **▼** to scroll to **Set Talk** and then press **⊖** under the word **Select**.
3. Press **▲** or **▼** to scroll to **REVIEW TALKING** and then press **⊖** under the word **Select**.
4. Press **▲** or **▼** to select ON/OFF to activate/deactivate the talking review function and then press **⊖** under the word **Select**.

BASIC PHONE FUNCTIONS

■ Using the Hands-Free Headset or Audio Jack

Your phone is equipped with 2 Headset jacks and 1 Audio Neckloop Jack. One headset jack is located on the left side of the handset and the other headset jack is located on the left side of the base. The audio jack is located on the left side of the base. These jacks are amplified, allowing you to adjust both the tone and volume the same as you would through the handset (see page 34 for amplification instructions).

The Audio Neckloop Jack - the 3.5mm Audio Neckloop jack allows you to listen through your device while speaking into the speakerphone.

The Headset Jack – the 2.5mm Headset jack allows you to listen and speak through your hands-free headset. This 2.5mm phone headset jack accommodates a variety of optional hands-free accessories including headphones, neckloops, silhouettes, and cellular accessories.

When a 2.5mm audio device is plugged in, the incoming audio signal to the handset will now be transferred to the headset jack. No output on the handset or speakerphone will be heard.

To use the cordless handset headset jack:

As soon as you plug your headset into the headset jack on the cordless handset, it will be activated.

To use the base audio neckloop jack:

1. Plug your neckloop, headphones, headset or other accessory into the base Audio jack.
2. If you want to speak into the handset, lift the handset, listen for dial tone and dial the number. Speak into the handset and adjust your volume. To end the call, replace the handset to the base.
3. If you want to speak into the speakerphone, press the **Speaker** key, listen for dial tone and dial the number. Speak into speakerphone (the conversation will be heard through both your audio equipment and over the speakerphone) and adjust your volume. To end the call, press the **Speaker** key again on the base.

To use the base headset jack:

1. Plug your neckloop, headphones, headset or other accessory into the base Headset jack.
2. Press the **Headset** key, listen for dial tone and dial the number. Talk into the headset microphone and adjust your volume (see below for amplification instructions). To end the call, press the **Headset** key.

■ Using the Base Amplification Function

Your ClearSounds® A1600 is equipped with a specialized amplification function designed to adjust to your needs. Flexibility in the management of amplification and tone is important when trying to achieve listening clarity. Be sure to try all levels of amplification and tone to find the best level for your hearing needs.

The **Volume** and **Tone** control on the front panel of the phone allow you to adjust the volume of the headset jack and neckloop jack during a call. During a call, adjust the controls to fit the levels to your hearing requirements.

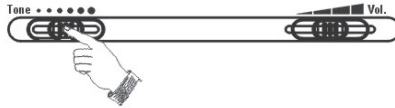

Using the Amplification Reset Override Switch (located on the back of the base)

The ClearSounds® A1600 is designed with unique features to protect users from being exposed to dangerous sound levels. You are able to switch between automatic or manual amplification, and you should select the setting that best suits your needs.

Set ON – When the Amplification Reset Override Switch  is set to ON, the amplify function will be ON every time a call starts. The user will no longer need to remember to press the **Amplify** key with every telephone conversation. When the phone hangs up, the amplify setting will remain ON.

Set OFF – When the Amplification Reset Override Switch  is set to OFF, the amplify function will be OFF every time a call starts. This allows people who do not require the level of amplification offered on the phone to use it. Every time a call starts, the user will need to press the **Amplify** key in order to gain the extra level of amplification and tone control. When the phone hangs up, the **Amplify** key will reset to OFF.

Important: You may manually turn ON and OFF the amplify function during a conversation by simply pressing the **Amplify** key.

NOTE: Your ClearSounds® A1600 comes from the factory preset in the OFF position. If you would like to override the factory preset, simply change the selection on the underside of the phone to ON.

■ Using your Base Speakerphone

When using the speakerphone, you can enjoy the convenience of hands-free conversation.



For optimal speakerphone performance, avoid the following:

- Areas with high background noise (The microphone might pick up these sounds and prevent the speakerphone from going into the receiving mode when you finish talking).
- Surfaces affected by vibration.
- Recessed areas such as in a corner, under a cupboard, or next to a cabinet, which can generate an echo effect.

■ Answering a Call

1. To answer a call, press the **Speaker** key on the base.
2. Adjust your volume by using the volume control V- or V+ located on right side of the phone.
3. To end the call, press the **Speaker** key again on the base.



The display will show a **Hold** option once you have a call established. To put a call on hold:

1. Press  under the word **Hold** once. The LCD will display "Call on hold."
2. To continue the conversation, simply press  under the word **unhold**.

■ Making a Call

1. Press the **Speaker** key on the base and listen for a dial tone.
2. Dial the number you want to call.
3. Adjust your volume by using the volume control V- or V+ located on right side of the phone.
4. When finished, press the **Speaker** key to hang up.

The display will show a **Hold** option once you have a call established. To put a call on hold:

1. Press  under the word **Hold** once. The "LCD will display "Call on hold".
2. To continue the conversation, simply press  under the word **Unhold**.

Dialing from Standby Mode

You can enter the desired phone number in standby mode, which allows you to verify the number before dialing. If you have the TALKING DIALING function turned ON, the number will be announced as you dial (see page 32 for more information). Follow these steps:

1. Enter a telephone number (up to 32 digits) and verify it is correct. If you make a mistake while entering a number, press  under the word **Clear** to delete it.
2. When the number appears correctly, press the **Speaker** key and it will dial.

Dialing from the Caller ID List (see page 42)





Dialing from the Redial List (see page 39)

■ One-Touch Memory Setting & Dialing







The base allows you to program 8 frequently dialed numbers in the photo speed dial keys and 1 emergency speed dial key. Each memory key can store up to 24 digits. You can insert a 3 second pause into dialing or memory storage in order to access custom and telebanking services, long distance, calling cards, etc. Press the **Redial** key at the desired point in the number to insert the pause and the letter **P** will appear at the pause entry.

Storing Memory Numbers (while the telephone is not in use)

Method 1:

1. Press and hold one of the Memory dial keys for at least 2 seconds, and the display will show "**Number:**". Enter the number and then press  under the word **Save**.
2. The display will show "**Name:**" Enter the name you want to use and then press  under the word **Save** (see page 44).
3. The display will show the list of ring tones to select from. Press  or  to select the desired ring tone. Press  under the word **Select**.
4. Repeat for each Memory dial key you want to use.

Method 2:







1. Use the keypad to enter the number you want to store. You can use  under the word **Clear** to edit the number.
2. Press and hold one of the Memory dial keys for at least 2 seconds, and the display will show the number you have entered. Press  under the word **Save**.
3. The display will show "**Name:**" Enter the name you want to use and then press  under the word **Save** (see page 44).
4. The display will show the list of ring tones to select from. Press  or  to select the desired ring tone. When adjusting the Melody, the handset plays the selected melody. Press  under the word **Select**.
5. Repeat for each Memory dial key you want to use.

Dialing from Memory Numbers

1. In standby mode, press one of the Photo Dial keys, the display will show the corresponding number. If you selected the wrong memory dial, either select the correct memory dial or press  under the word **Clear** repeatedly until you get back to the main screen.
2. Press the **Speaker** key and the phone will begin to dial.

NOTE: Entering a new number in the same location will automatically erase the previous number.

Erase Memory Numbers

1. Press  under the word **PhoneBk** to enter the phonebook.
2. Press  or  repeatedly until you reach the desired entry, and then press  under the word **Options**.
3. Press  or  to scroll to **Erase** and then press  under the word **Select** and the entry will be immediately deleted.
4. Repeat for each entry to be erased.



■ **Inserting Photos in Memory Keys**

1. Cut your photo using the template provided as a guide.
2. Remove the transparent cover of the memory key and insert the photo and replace the cover or slide the photo in the top slot of the cover.

■ Mute Setting

During a conversation, you can temporarily switch your phone's microphone off to have a private, off-line conversation by using the mute feature. The party on the phone cannot hear you but you can hear them. A conversation can be muted while using the handset, speakerphone or hands-free headset feature.



To mute your call any time during the conversation:

1. Press  under the word **Mute** on the screen once. "**Mute**" appears on the base LCD.
2. Press  under the word **Unmute** on the screen again to cancel and return to your phone conversation.

■ Hold Function

The display will show a **Hold** option once you have a call established.

To put a call on hold:



1. Press  under the word **Hold** once. The LCD will display "**Call on hold**". Hanging up the handset will not disconnect the call.
2. To continue the conversation, simply pick up the handset or press  under the word **Unhold**.

■ Redial Function

The Redial key is used to quickly redial the last number you dialed.

1. Press the **Speaker** key and listen for the dial tone.
2. Press the **Redial** key. The phone will redial up to 32 digits automatically.

Dialing from the Redial List

1. Press the **Redial** key in standby mode.
2. Press  or  repeatedly until you find the number you want to dial. If you have activated the **Talking Review** feature, the number for each record will be announced as you scroll through the Redial list.
3. Press the **Speaker** key to dial.

Use Redial List Options

You can add a number to the phonebook from your redial list or delete a number in your redial list.

1. Press the **Redial** key in standby mode.
2. Scroll to the desired number by using ▲ or ▼.
3. When the number appears on the display, press ⊖ under the word **Options** to choose the desired option:
 - **Store:** allows you to add the number to the phonebook. To add, follow instructions in “**Adding Phonebook Entries**” on page 44.
 - **Erase:** allows you to delete the selected number. As soon as you select **Erase**, the number is deleted and the next number will be displayed.
 - **Erase All:** allows you to delete the complete redial list. You will be asked “**Erase All?**”. Press ⊖ under the word **Yes** to confirm or under the word **No** to cancel.

Note: If no numbers are found in the Redial list, the display will show “**Empty List**”. When the Redial list is full, each time you dial a new number, the oldest number stored is automatically erased.

CALLER ID (CID) OPERATION

In order to utilize the Caller ID features, you must subscribe to Caller ID service through your local phone provider. This product can provide information only if both you and the caller are in areas offering Caller ID service and both telephone providers use compatible equipment.

This telephone automatically displays an incoming caller’s number/name along with the date and time of the call. It will record up to 20 calls of up to 16 digits and store the data into memory.

■ Receiving CID Records

When you receive a call, the Caller ID information is transmitted between the first and second ring. The Caller ID information appears on the display while the phone rings, giving you a chance to monitor the information and decide whether or not to answer the call.

■ Storing CID Records

Your base telephone's Caller ID memory stores the data for the 20 most recent calls received. When the 21st call is received, the oldest Caller ID record (1st call) is automatically deleted.

You may review the stored information at any time. Calls received since your last review show as NEW in the display. Calls that have not been previously reviewed but were received from the same number more than once show as REPT in the display.

■ Talking Caller ID Setting

Your ClearSounds® A1600 can announce the caller's number between rings. If you have stored a phone number in the phonebook and recorded the corresponding name, when an incoming call with this number comes in, the phone will announce the name associated with this number. See **page 41** for instructions on changing the Talking Caller ID setting and **page 45** for instructions on recording a phonebook name.

■ Caller ID on Call Waiting

When you subscribe to Call Waiting Caller ID service from your local telephone provider, the telephone will display the Caller ID information of the second call while you are on the first call.

Caller 1
436-1234

Caller 1
4
Caller 2
291-5678

1. When you are on existing call, a tone will emit, and the Caller ID displays the incoming caller's information.
2. Press the **Call Waiting** key to put the current call on hold and answer the second caller.
3. If the second call is not answered, the Caller ID information will be transferred into the Caller log. The caller information is considered "old".
4. When you have finished with the second call, press the **Call Waiting** key to resume your conversation with the first caller.

■ Caller ID List

Viewing the Caller List

As calls are received and stored, the display is updated to let you know how many calls have been received. Records will be listed in the order they were received.

To scroll through the CID records:

From the main screen, use ▲ or ▼ to scroll through the entries. Press ▼ to review the newest CID record and press ▲ to review the oldest CID record first.

Dialing a Number from the Caller List

Use ▲ or ▼ to locate the desired record. If you need to change the dialing format (7 digits, 10 digits or 11 digits), simply press the * key until you see the desired format of the number you would like to dial. For example, if the original number in the Caller ID list was 800-965-9043, press the * key repeatedly to change it to 1-800-965-9043 or 965-9043. Pick up the handset or press the **Speaker** key to dial that number.

Deleting a Single Caller List Record

1. Use ▲ or ▼ to locate the record.
2. Press ⊖ under the word **Options** and press ⊖ under the word **Erase** and the entry is automatically erased.
3. Continue to select records to delete or press ⊖ under the word **Exit** to return to the main screen.

Deleting All Caller List Records

1. Press ▲ or ▼ to locate any record.
2. Press ⊖ under the word **Options** and press ▼ to scroll to **Erase all** and press ⊖ under the word **Select**.
3. The display will show "**Erase all?**". Press ⊖ under the word **Yes** to confirm or ⊖ under the word **No** to cancel. The display will show "**Empty List**".

Storing Caller List Records

1. Use ▲ or ▼ to locate the record.
2. Press ⊖ under the word **Options** and use ▼ to move to **Store** and press ⊖ under the word **Select**.
3. The number will appear on the display. Press ⊖ under the word **Save** to confirm or press ⊖ under the word **Clear** to erase and re-type the number and then press ⊖ under the word **Save**.
4. "**Name:**" will appear with the caller's name listed. Press ⊖ under the word **Clear** to erase and re-type the name using the dial keypad (see page 44) or ⊖ under the word **Save** to save the name as displayed.
5. The display will show the list of ring tones to select from. Press ▲ or ▼ to select the desired ring tone. Press ⊖ under the word **Select**.
6. Repeat for each Caller ID entry that you want to save.

Note: You can record a voice prompt for the stored name. See page 45 for instructions.

PHONEBOOK OPERATION

Reminder: Press ⊖ under the word **Back** or **Exit** on the screen from any menu to return to the previous screen. Otherwise, after 20 seconds, the phone will automatically return to the main screen from any menu if no key is pressed.

The built-in phonebook allows you to store frequently used numbers so that you can easily make a call without having to remember or enter the phone number. You can store up to 30 numbers in the phonebook.

Character Map







To enter a specific alphanumeric character, press the relevant key one or more times for the required character according to the following table: once for the first character, twice for the second and so on.

Key	Characters in the displayed order
0	0
1	(spc) _ * , 1
2	Aa Bb Cc (2
3	Dd Ee Ff) 3
4	Gg Hh Ii # 4
5	Jj Kk Ll / 5
6	Mm Nn Oo ' 6
7	Pp Qq Rr Ss 7
8	Tt Uu Vv ? 8
9	Ww Xx Yy Zz 9

Clarification:

- If you want to shift the case between upper and lower, between entering letters, press the * key.
- When entering the same letter twice or a different letter with same key, wait for a few seconds for the cursor to move automatically and then select the next letter.

■ Adding Phonebook Entries







1. Enter a phone number while in standby mode and then press  under the word **Save**.
2. The number will appear on the display. Press  under the word **Save**.
3. "**Name:**" will appear on the display. Enter the name you want to use and then press  under the word **Save**.
4. The display will show the list of ring tones to select from. Press  or  to select the desired ring tone. Press  under the word **Select**.
5. Repeat if necessary.



Note: If you make a mistake while entering a name or a number, press  under the word **Clear** to correct it. Each time you press this key, the last digit is deleted.

■ Using a Pause

(used when entering a phonebook entry or photo memory key)
You can insert one 3 second pause into dialing or memory storage in order to access custom and telebanking services, long distance, calling cards, etc. Press the **Redial** key at the desired point in the number to insert the pause and the letter **P** will appear at the pause entry.

■ Viewing Phonebook Entries







1. Press  under the word **PhoneBk** to enter the phonebook.
2. Press  or  repeatedly until you reach the desired entry.
3. Press  under the word **Options** and then press  or  to scroll to **Edit** and then press  under the word **Select** to view the details.

Note: If you have activated the **Talking Review** feature, every time you press  or , the system will announce the number or name of the highlighted entry.

■ Dialing A Number from the Phonebook

Find the number you want to dial (refer to **Viewing the Phonebook Entries** above), then press the **Speaker** key to dial.

■ Using Phonebook Options

1. Press  under the word **PhoneBk** to enter the phonebook.
2. Press  or  repeatedly until you reach the desired entry, and then press  under the word **Options**.
3. Press  or  to choose the desired option:
 - **Play Voice:** allows you to play the voice prompt of the selected entry. If you have recorded a name for this entry, the phone will announce the name. Otherwise, it will announce the number.
 - **Record Voice:** allows you to record the name for the selected entry.
 - **Erase Voice:** allows you to delete the name you have recorded for the selected entry.

- **Edit:** allows you to edit the selected entry
- **Erase:** allows you to delete the selected entry



Note: After editing the name, you need to press the ▼ to edit the number.

Note: If you record a voice prompt for an entry, an icon  will appear before the name of the entry.

SETTING UP YOUR CORDLESS HANDSET

MENU NAVIGATION





Screen Navigation

If you press  under the word **Back** on the screen from any menu, the phone returns to the previous screen. To return to the main screen at any time, press . The phone will automatically return to the main screen from any menu if no key is pressed for 30 seconds.

“Standby” can mean that you are at the main screen or can also mean that you are not on a live call and do not have dial tone engaged.

In standby mode, you can press  to turn the LCD backlight on if it is currently off.

To Access a MENU Option



1. Press  under the word **Menu** on the screen to display the main menu list.
2. To scroll through menu options, press up  or down  repeatedly. You will see an arrow to the left of the menu item that is currently selected.
3. To select one of the menu options, press  under the word **Select** when the desired menu item appears with the arrow to its left.

MENU MAP – this identifies how the menu is displayed for navigation

Main Menu	Submenu I	Submenu II
Call List (Caller ID Book) (p. 69)	Add to PB (Phonebook) (p. 70) Delete (p. 69) Delete All (p. 70)	
Phonebook (PB) (p. 71)	Add (p. 72) View (p. 72) Edit (p. 72) Delete (p. 73) Delete All (p. 74) PB Status (p. 74) PB Record (p. 73)	
BS (Base) Settings	Delete HS (p. 50) Dial Mode (p. 52) Flash Time (p. 53) Modify PIN (Personal Identification Number) (p. 54)	
HS (Handset) Settings	Alarm (p. 75)	
	Ring Setup (p. 56)	INT. (Internal) Ring (p. 56) EXT. (External) Ring (p. 56) Ring Volume (p. 56)
	Tone Setup	Key Tone (p. 58) Range Alarm (p. 52)
	Language (p. 59) HS Name (p. 50) LCD Contrast (p. 54) Auto Answer (p. 58) Amplified (p. 61) Talk Keypad (p. 60)	









Main Menu	Submenu I	Submenu II
HS (Handset) Settings (Continued)	Date & Time (p. 55)	Date Format
		DD-MM-YY
		MM-DD-YY
		Time Format
		12 HR
		48 HR
		Set Time
		Set Date
	Selected Base (p. 51)	
Registration (p. 49)		
ANS. Machine (p. 77)	same as TAM setup (see below)	
TAM setup (p. 77)	MSG Playback (p. 84) Delete All (p. 85) Memo (p. 86) TAM On/Off (p. 77)	
	TAM Settings (p. 78)	Answer Mode (p. 79)
		TAM Language (p. 79)
		Announce (p. 80)
		Set Ring (p. 78)
		Record Time (p. 78)
		Change PIN (p. 87)

HANDSET SET UP

Reminder: Press  under the word **Back** on the screen from any menu to return to the previous screen. To return to the main screen, press . Otherwise, after 30 seconds, the phone will automatically return to the main screen from any menu if no key is pressed.

■ Registering the Handset









The supplied handset is already registered to the base unit, and you can register up to 4 additional handsets to the base.

1. Before registering an additional handset to the base, you should press and hold the page key , which is located on the main base until you hear a loud tone and then release it.
2. Press  under the word **Menu** on the screen of the handset you are registering to display the main menu list.
3. Press up  or down  to scroll to **Registration** and then press  under the word **Select**.
4. Press up  or down  to scroll through the base list and select one of the bases and then press  under the word **Select**. The handset will search for the requested base.
5. If the base is found, and the handset is successfully registered, you will be prompted to enter the PIN code (the default PIN is 0000). Upon validation of the PIN, the Registration tone will sound and the base assigns a number to the handset. If the PIN entered is invalid, a warning tone will sound and the handset will return to the previous registration state.
6. If the base is not found, the handset will behave according to the **Out of Range** description found on page 52.

Note: Remove Handset 1 from the main base while registering additional handsets.

■ Handset Name









This feature allows you to give each registered handset a name in order to easily recognize each handset if you have more than one registered to the base. To set the handset name:

1. Press  under the word **Menu** on the screen to display the main menu list.
2. Press up  or down  to scroll to **HS Settings** and then press  under the word **Select**.
3. Press up  or down  to scroll to **HS Name** and then press  under the word **Select**.
4. Enter the handset name (up to 9 characters) by using the keypad (see page 71 for the character map and instructions) and then press  under the word **Save** to confirm and exit. The handset name will be displayed above your handset number in standby mode.

Note: If you make a mistake while entering the name, press  under the word **Erase** to correct it. Each time you press this key, the last character is deleted.

■ Delete/Terminate Handset











This function allows you to delete a handset that is registered to the base. To delete/terminate a handset:

1. Press  under the word **Menu** on the screen to display the main menu list.
2. Press up  or down  to scroll to **BS Settings** and then press  under the word **Select**.
3. Press  under the word **Select** to select **Delete HS**. The display will show PIN?
4. Enter the PIN (the default PIN is 0000) and then press  under the word **Select**. If the PIN is validated, you will see a list of registered handsets.
5. Press up  or down  to scroll to the desired handset that you would like to delete and press  under the word **Select**. The selected handset will no longer be registered to the base.

Note: If you selected the current handset or a non-registered handset, a warning tone will be heard.







■ Base Selection

This function allows you to select a base from those already registered to the handset. To select a base:

1. Press  under the word **Menu** on the screen to display the main menu list.
2. Press up  or down  to scroll to **HS Settings** and then press  under the word **Select**.
3. Press up  or down  to scroll to **Selected Base** and then press  under the word **Select**.
4. Press up  or down  to select the base you want and then press  under the word **Select**. If you select a non-existent base, the handset will sound a warning tone.
5. The display will show **Searching** and then **BS Selected**. The display will automatically return to the previous menu screen.

■ Handset Reset













This function allows you to reset the handset settings for Alarm, Audio Setup, Ring Setup, Tone Setup, Language, HS Name, Auto Answer and Date & Time to the initial factory settings. To reset the handset:

1. Press  under the word **Menu** on the screen to display the main menu list.
2. Press up  or down  to scroll to **Default** and then press  under the word **Select**. You will be prompted to enter the PIN.
3. Enter the PIN (the default PIN is 0000) and then press  under the word **Select**. If the PIN is validated, the display will show **Confirm?**.
4. Press  under the word **Select** to confirm or press  under the word **Back** to cancel and exit.

If successful, the handset settings will be reset to the initial factory settings, otherwise the settings will remain. After resetting, the handset will return to standby mode.









■ Out of Range Alarm

This function allows you to know when the handset is out of range of the base, and a beep will sound. Your ClearSounds® A1600 comes from the factory preset for Out of Range Alarm ON. To change this setting:

1. Press  under the word **Menu** on the screen to display the main menu list.
2. Press up  or down  to scroll to **HS Settings** and then press  under the word **Select**.
3. Press up  or down  to scroll to **Tone Setup** and then press  under the word **Select**.
4. Press down  to select **Range Alarm** and then press  under the word **Select**.
5. Press up  or down  to select **On** or **Off** and then press  under the word **Select**.









■ Dialing Mode

Your ClearSounds® A1600 comes from the factory preset for touch-tone service. Should you need to change this setting based on the type of phone service you have, use **Tone** for touch-tone service or **Pulse** for rotary dialing. **NOTE:** If you are not sure which dialing mode to select, please contact your local phone service provider. To change this setting:

1. Press  under the word **Menu** on the screen to display the main menu list.
2. Press up  or down  to scroll to **BS Settings** and then press  under the word **Select**.
3. Press down  to select **Dial Mode** and then press  under the word **Select**.
4. Press up  or down  to select **Tone** or **Pulse** and then press  under the word **Select**.



■ Call Waiting (Flash)

Your ClearSounds® A1600 comes from the factory preset for Flash Time to 600ms. Flash timing is the signaling process that tells the phone system when a phone is on hook or off hook. The United States uses a 600ms timing sequence. The European Union uses a 300ms timing sequence. You can choose from 100ms, 300ms or 600ms. To change this setting:

1. Press  under the word **Menu** on the screen to display the main menu list.
2. Press up  or down  to scroll to **BS Settings** and then press  under the word **Select**.
3. Press down  to select **Flash Time** and then press  under the word **Select**.
4. The display shows the current setting. Press up  or down  to choose from 100ms, 300ms, or 600ms and then press  under the word **Select**.











Note: If you subscribe to Call Waiting on Caller ID, you will receive Caller ID information (if available) on Call Waiting calls (see page 68).

If you subscribe to Call Waiting service from your local phone provider, during a phone call you will hear a beep to indicate another call is waiting on the line.



1. To connect to the waiting call, press  under the word **Flash**, and your original call is put on hold. The display will show **R**.
2. To switch between the two calls, press  under the word **Flash**.

■ Modify PIN (Personal Identification Number)

Your ClearSounds® A1600 is equipped with a PIN, which is used when re-setting the handset to factory default settings. The default PIN is 0000. **We suggest that you do not change the PIN from 0000**, but if you need to change the PIN:







1. Press  under the word **Menu** on the screen to display the main menu list.
2. Press up  or down  to scroll to **BS Settings** and then press  under the word **Select**.
3. Press up  or down  to scroll to **Modify PIN** and then press  under the word **Select**.
4. The display shows "PIN ?". Enter the current PIN, then press  under the word **Select**. If the old PIN is validated, you will be prompted to enter a new PIN. If the old PIN is not validated, a warning beep will sound and you will be returned to the **Modify PIN** menu.
5. Enter the new PIN and then press  under the word **Select**. You will be asked to confirm the PIN. Enter the new PIN again and then press  under the word **Select**.

LCD DISPLAY

Reminder: Press  under the word **Back** on the screen from any menu to return to the previous screen. To return to the main screen, press . Otherwise, after 30 seconds, the phone will automatically return to the main screen from any menu if no key is pressed.















■ LCD Settings

Contrast Settings















1. Press  under the word **Menu** on the screen to display the main menu list.
2. Press up  or down  to scroll to **HS Settings** and then press  under the word **Select**.
3. Press up  or down  to scroll to **LCD Contrast** and then press  under the word **Select**.

Date & Time Format Settings

If you have Caller ID service, the date and hour will be automatically set when you receive your first call. If you currently do not have Caller ID service through your phone company, please follow the directions below. You can change the format of the time and date to your preference.

1. Press  under the word **Menu** on the screen to display the main menu list.
2. Press up  or down  to scroll to **HS Settings** and then press  under the word **Select**.
3. Press up  or down  to scroll to **Date & Time** and then press  under the word **Select**.
4. Press  under the word **Select** to select **Date Format**.
5. Press up  or down  to select **DD-MM-YY** or **MM-DD-YY** and then press  under the word **Save**. You will return to the previous screen.
6. Press down  to select **Time Format**.
7. Press up  or down  to select **12 - Hour** or **24 - Hour** and then press  under the word **Save**.

Set Date & Time

1. Press  under the word **Menu** on the screen to display the main menu list.
2. Press up  or down  to scroll to **HS Settings** and then press  under the word **Select**.
3. Press up  or down  to scroll to scroll to **Date & Time** and then press  under the word **Select**.
4. Press up  or down  to scroll to **Set Date** and then press  under the word **Select**.
5. Enter the current date using the keypad and then press  under the word **Save**. You will return to the previous screen.
6. Press down  to select **Set Time** and then press  under the word **Select**.
7. Enter the current time using the keypad and then press  under the word **Save**.

Note: If you select **12 - Hour clock**, AM/PM will appear at the right of the time in standby mode. If you select **12 - Hour**, you will still need to enter the time in the **24 - Hour** format.

■ LCD Descriptions

Your ClearSounds® A1600 has a large LCD screen that provides useful information. Your screen has a backlight that automatically switches off after 10 seconds of inactivity.

See page 16 for LCD Window Icons Descriptions



■ Reviewing Voice Mail Messages

You must subscribe to Voice Mail from your phone service provider to use this feature.

NOTE: You are not able to utilize voice mail and the built-in answering machine at the same time.

When a voice mail message is left, the screen will display the  icon and the message will be saved as a call. If you have new messages, you will hear a stutter dial tone when you pick up the handset. You can utilize one of the **M1 - M4** one-touch memory dial buttons to program your voice mail access phone number. Follow the steps provided from your phone service provider to listen to your message(s).















HANDSET SETTINGS

Reminder: Press  under the word **Back** on the screen from any menu to return to the previous screen. To return to the main screen, press . Otherwise, after 30 seconds, the phone will automatically return to the main screen from any menu if no key is pressed.

■ Ringer Setting



Audible Ringer

You can adjust the ringer of your phone and you can select separate ring tones for external calls (**EXT**) received through the phone network (outside calls) and internal calls (**INT**) received from other handsets registered to the base.

1. Press  under the word **Menu** on the screen to display the main menu list.
2. Press up  or down  to scroll to **HS Settings** and then press  under the word **Select**.
3. Press down  to scroll to **Ring Setup** and then press  under the word **Select**.
4. Press  under the word **Select** to select **INT Ring** or press down  to select **EXT Ring**, and then press  under the word **Select**.
5. Press up  or down  to select the ring tone from Melody 1-Melody 10. When adjusting the Melody, the handset plays the selected melody.
6. Press  under the word **Select**.
7. To adjust the volume level, select **Ring Volume** and then press  under the word **Select**. You can select and adjust the volume from Volume 1-Volume 5, or Off. When adjusting the Volume, the handset plays the selected loudness.
8. Press  under the word **Select**.



Note: If you set the volume to "Off", when a call comes in, only the **New Call** information appears on the LCD and the phone will not ring.

Visual and Vibrating Ringer

You can activate the visual ringer and vibrating handset function. A bright LED light will flash and the handset will vibrate when the phone rings. To turn this feature on/off: In standby mode, press and hold  until the  icon appears to activate and press and hold  again to deactivate.











■ Turning the Handset “Power On/Off” Mode

The A1600 handset can be turned to “Power Off” mode, which can be a convenient way to prevent the phone from ringing without having to change the ringer setting. When you turn the handset to “Power Off” mode, calls can’t be made or received until you turn the power back “On”.

1. In Standby Mode (not during a live call):
2. To turn the handset “Off”, simply press and hold  until the display turns off.
3. To turn the handset “On”, you can either:
4. Place the handset back into the base and the handset will automatically power on.
5. Press and hold  until the display turns on.











■ Auto Answer Setting

Your ClearSounds® A1600 comes from the factory preset for Auto Answer set to OFF. With this feature turned ON, when the phone is in the base, you can answer a call by simply picking up the handset from the base. You do not need to press any key to answer. To change this setting:

1. Press  under the word **Menu** on the screen to display the main menu list.
2. Press up  or down  to scroll to **HS Settings** and then press  under the word **Select**.
3. Press up  or down  to scroll to **Auto Answer** and then press  under the word **Select**.
4. Press up  or down  to select **On** or **Off** to enable/disable the function and then press  under the word **Select**.

■ Keypad Tones Setting











Your ClearSounds® A1600 comes from the factory preset for menu Keypad Tones ON. This refers to having an audible tone when navigating the menu to verify a selection. To change this setting:

1. Press  under the word **Menu** on the screen to display the main menu list.
2. Press up  or down  to scroll to **HS Settings** and then press  under the word **Select**.
3. Press up  or down  to select **Tone Setup** and then press  under the word **Select**.
4. Press  under the word **Select** again to select **Key Tone**.
5. Press up  or down  to select **On** or **Off** to activate/deactivate the audible tone function and then press  under the word **Select**.



Note: In certain error conditions, a warning tone will sound when an incorrect key is pressed.





■ Language Setting

The handset supports up to 7 predefined languages: English, French, Spanish, German, Italian, Dutch and Russian. Changing the language will cause the menu to be displayed in the new language. To select a language:

1. Press  under the word **Menu** on the screen to display the main menu list.
2. Press up  or down  to scroll to **HS Settings** and then press  under the word **Select**.
3. Press up  or down  to select **Language** and then press  under the word **Select**.
4. The languages will be displayed. Press up  or down  to scroll through the language options. Each language will be displayed in its own native translation.
5. Select the desired language and then press  under the word **Select**.











To go back to the English menu if you can't read the current language displayed:

1. Press the **Left** soft key ().
2. Press down  3 times.
3. Press the **Left** soft key ().

4. Press down  3 times.
5. Press the **Left** soft key ().
6. Press up  or down  to find "**English**" in the list of languages.
7. Press the **Left** soft key () to save the setting.

■ Talking Keypad

Your ClearSounds® A1600 comes from the factory preset for Talking Dialing Mode set to OFF. This feature allows you to pre-dial the number you wish to call and you will hear the number announced as you dial as well as display the numbers on the LCD. To change this setting:



1. Press  under the word **Menu** on the screen to display the main menu list.
2. Press up  or down  to scroll to **HS Settings** and then press  under the word **Select**.
3. Press up  or down  to scroll to **Talk Keypad** and then press  under the word **Select**.
4. Press up  or down  to select **On** or **Off** to activate/deactivate the audible tone function and then press  under the word **Save**.

BASIC PHONE FUNCTIONS

Using the Handset Amplification Function

Your ClearSounds® A1600 is equipped with a specialized amplification function designed to adjust to your needs. Flexibility in the management of amplification and tone is important when trying to achieve listening clarity. Be sure to try all levels of amplification and tone to find the best level for your hearing needs.

Without pressing the **AMP (Amplify)** key, the handset provides some volume and tone control. Once the **AMP** key is activated, the phone will provide even greater amplification. The **AMP** key is located on the right side of the handset.

During a call, adjust the **Vol +** or **Vol -** keys (located on the left side of the handset) to fit your hearing requirements. You can also adjust the volume by pressing up  or down  on the navigation key. Adjust the **Tone** key (located on the right side of the handset), which is a 3-level adjustment, to fit your hearing requirements.

Using the Auto Amplification Feature











Your ClearSounds® A1600 is designed with unique features to protect users from being exposed to dangerous sound levels. You are able to switch between automatic or manual amplification, and you should select the setting that best suits your needs.

Note: As long as the Amplify mode is ON, the red Amplify Indicator Light will remain lit (located at the top of the handset, in the white “dome”).

Set ON – When the Amplification Feature is set to ON, the amplify function will be ON every time a call starts. The user will no longer need to remember to press the **AMP** key with every phone conversation. When the phone hangs up, the amplify setting will remain ON.

Set OFF – When the Amplification Feature is set to OFF, the amplify function will be OFF every time a call starts. This allows people who do not require the level of amplification offered on the phone to use it. Every time a call starts, the user will need to press the **AMP** key in order to gain the extra level of amplification and tone control. When the phone hangs up, the amplify setting will reset to OFF.





Your ClearSounds® A1600 comes from the factory preset for Auto Amplification set to OFF. To change this setting:

1. Press  under the word **Menu** on the screen to display the main menu list.
2. Press up  or down  to scroll to **HS Settings** and then press  under the word **Select**.
3. Press up  or down  to scroll to **Amplified** and then press  under the word **Select**.
4. Press up  or down  to select **Off** or **On** and then press  under the word **Save**.





■ Using your Handset Speakerphone



The handset has a built-in speakerphone. When using the speakerphone, you can enjoy the convenience of hands-free conversation. To activate the speakerphone:

In standby mode

1. Press  twice to turn the speakerphone on. The  icon will appear on the LCD.
2. Press  to turn the speakerphone off and switch to handset mode. The  icon will disappear from the LCD.

During a call

1. Press  to turn the speakerphone on. The  icon will appear on the LCD.
2. Press  to turn the speakerphone off and return to handset mode. The  icon will disappear from the LCD.



To adjust the volume, press the **Vol+** or **Vol-** keys on the side of the handset or press up  or down  on the navigation key.

For optimal speakerphone performance, avoid the following:



- Areas with high background noise (The microphone might pick up these sounds and prevent the speakerphone from going into the receiving mode when you finish talking).
- Surfaces affected by vibration.
- Recessed areas such as in a corner, under a cupboard, or next to a cabinet, which can generate an echo effect.

■ Answering a Call from the Cordless Handset

Cordless Handset out of the base

1. To answer a call, press  and speak into the handset.
2. Adjust your volume and tone settings if needed.
3. To end the call, press  or replace the handset to the base.



Cordless Handset in the base

1. If you have activated the Auto Answer function (see page 58), simply lift the handset out of the base and speak into the handset.
2. If you have not activated the Auto Answer function, lift the handset out of the base and press  and speak into the handset.
3. Adjust your volume and tone settings if needed.
4. To end the call, press  or replace the handset to the base.

After you hang up, the LCD will display the call duration.





During the call, the base LCD will display the call duration.

■ Making a Call from the Cordless Handset

1. Pick up the handset and press . The  icon appears on the LCD. Listen for a dial tone.
2. Dial a number. If you make a mistake while entering a number, hang up and begin again.
3. Adjust your volume and tone settings if needed.
4. To end the call, press  or replace the handset to the base.

Dialing from Standby Mode

You can enter the desired phone number in standby mode, which allows you to verify the number before dialing. If you have the TALKING DIALING function turned ON, the number will be announced as you dial (see page 60 for more information). Follow these steps:

1. In standby mode, dial the number you want to call (up to 32 digits). To insert a pause, press right . If you make a mistake while entering a number, press  under the word **Erase** to delete it.
2. When the number appears correctly, press  to dial.
3. Adjust your volume and tone settings if needed.
4. To end the call, press  or replace the handset to the base.

Dialing from the Memory M1 – M4 keys

Press one of the **M1 – M4** memory dial keys and the phone will automatically begin to dial (see page 65 on how to program the memory dial keys). **Note:** If you turn the **Key Lock** feature on, the **M1 – M4** keys will still be operational (see page 75 for more details).

Dialing from the Caller ID List (see page 69)





Dialing from the Redial List (see page 66)

■ One-Touch Memory Setting & Dialing

Cordless Handset

The handset allows you to program 4 frequently dialed numbers. Each memory key can store up to 24 digits. You can insert one 3 second pause into dialing or memory storage in order to access custom and telebanking services, long distance, calling cards, etc. Press the right  button at the desired point in the number to insert the pause and the letter **P** will appear.

Storing M1-M4 Memory Numbers

1. Press the memory key (**M1-M4**) in standby mode.
2. The display shows “**Number ?**” Enter the desired number (up to 24 digits) and you can press  under the word **Erase** to erase digit(s). Then press  under the word **Save**.
3. Press up  or down  to select from Melody 1 through Melody 10 and then press  under the word **Select**.
4. Repeat if necessary.

Note: These will appear as the first four entries in your phonebook.

Viewing, Editing or Deleting M1-M4 Memory Numbers

You can view, edit, and delete the **M1-M4** memory dial number(s) by following the instructions in **Using the Phonebook Options**, found on page 73. The memory default names are **M1:**, **M2:**, **M3:**, **M4:**, and you can add a name after the **M1:- M4:**, but you can't delete the default name.

Dialing from M1-M4 Memory Numbers



In standby mode, press one of the memory keys (**M1-M4**), the display will show the corresponding number and begin to dial. If you selected the wrong memory dial, press  to hang up.

Note: If you turn the **Key Lock** feature on, the **M1 – M4** keys will still be operational (see page 75 for more details).

Mute Setting



During a conversation, you can temporarily switch your phone's microphone off to have a private, off-line conversation by using the **MUTE** feature. The party on the phone cannot hear you but you can hear them. A conversation can be muted while using the handset, speakerphone or hands-free headset feature.

To mute your call any time during the conversation:

1. Press  under the word **Mute** on the screen once. “**Muted**” appears on the handset LCD.
2. Press  under the word **Unmute** on the screen again to cancel and return to your phone conversation.





■ Redial Function - Handset

The **Redial** key is used to quickly redial the last number you dialed.

1. Press right  on the navigation key in standby mode. The LCD displays the last number you dialed.
2. Press  to dial.







Dial from the Redial Book

You can retrieve the last 10 numbers you have dialed and redial them quickly.

1. Press right  on the navigation key in standby mode.
2. If you want to scroll through the redial book, press up  or down  until you find the number you want to dial.
3. Press  to dial.



Use Redial List Options

You can add a number to the phonebook from your redial list or delete a number in your redial list.

1. Press right  on the navigation key in standby mode.
2. Scroll to the desired number by using up  or down .
3. When the number appears on the display, press  under the word **More** to choose the desired option:
 - **Add to PB (Phonebook)**: allows you to add the number to the phonebook. To add, follow instructions in “Adding Phonebook Entries” on page 72.
 - **Delete**: allows you to delete the selected number. As soon as you scroll to **Delete** and press  under the word **Select**, the number is automatically deleted.
 - **Delete All**: allows you to delete the complete redial list. You will be asked to confirm the delete. Press  under the word **Select** to confirm or  under the word **Back** to cancel.

Note: If no numbers are found in the Redial list, the display will show “**Empty**”. When the Redial list is full, each time you dial a new number, the oldest number stored is automatically erased.

CALLER ID (CID) OPERATION

Reminder: Press  under the word **Back** on the screen from any menu to return to the previous screen. To return to the main screen, press . Otherwise, after 30 seconds, the phone will automatically return to the main screen from any menu if no key is pressed.

In order to utilize the Caller ID features, you must subscribe to Caller ID service through your local phone provider. This product can provide information only if both you and the caller are in areas offering Caller ID service and both telephone providers use compatible equipment.

This phone automatically displays an incoming caller's number/name along with the date and time of the call. It will record up to 40 calls of up to 15 digits and store the data into memory.

■ Receiving CID Records

When you receive a call, the Caller ID information is transmitted between the first and second ring. The Caller ID information appears on the display while the phone rings, giving you a chance to monitor the information and decide whether or not to answer the call.

Out Of Area – this message will display when someone calls from an area where Caller ID service is not offered or is not yet providing number delivery to your area.

Private – this message will display when the caller has chosen to block the name and number from being sent.

■ Storing CID Records

Your phone's Caller ID memory stores the data for the 40 most recent calls received. When the 41st call is received, the oldest Caller ID record (1st call) is automatically deleted.

■ Caller ID on Call Waiting

When you subscribe to Call Waiting Caller ID service from your local phone provider, the phone will display the Caller ID information of the second call while you are on the first call.



1. When you are on existing call, a tone will emit, and the Caller ID displays the incoming caller's information.
2. Press **4** under the word **Flash** to put the current call on hold and answer the second caller.
3. When you have finished with the second call, press **4** under the word **Flash** to resume your conversation with the first caller.

■ Caller ID List

Viewing the Caller List

As calls are received and stored, the ↓ icon is displayed on the LCD. If the Caller ID memory is full, the ↓ icon will flash on the LCD. Records will be listed in the order they were received.

To scroll through the CID records:

Method 1: From the main screen, press up [?] to access the CID Book. Press up [?] or down [□] to scroll through the entries. Press up [?] to review the newest CID record and press down [□] to review the oldest CID record first.

Method 2: Press [▢] under the word **Menu** on the screen to display the main menu list. Press [▢] under the word **Select** to select **Call List**. Press up [?] to review the newest CID record and press down [□] to review the oldest CID record first.

If the call record has been reviewed, the ↑ icon will appear. If the call has not been reviewed, the ↓ icon will appear.





Dialing a Number from the Caller List

After you access the CID Book following the instructions in **Viewing the Caller List - Method 1:**







1. Press up [?] or down [□] to locate the desired record. If you need to change the dialing format (7 digits, 10 digits or 11 digits), simply press [▢] under the word **More** to display the 3 dialing formats. For example, if the original number in the Caller ID list was 800-965-9043, you might need to change it to 1-800-965-9043 or 965-9043 in order to dial out.
2. Press up [?] or down [□] to locate the desired format and press [☎] to dial.

Deleting a Single Caller List Record













1. Press [▢] under the word **Menu** on the screen to display the main menu list.
2. Press [▢] under the word **Select** to select CID List.

3. Press up  or down  to locate the desired record and press  under the word **More**.
4. Press down  to select **Delete** and then press  under the word **Select**. You will hear a confirmation beep and the LCD will display the next record.
5. Continue to select records to delete.



Deleting All Caller List Records

1. Press  under the word **Menu** on the screen to display the main menu list.
2. Press  under the word **Select** to select CID List.
3. Press  under the word **More**.
4. Press down  to scroll to **Delete All** and press  under the word **Select**.
5. "**Confirm ?**" will appear. Press  under the word **Select** to confirm or press  under the word **Back** to exit.
6. If you select **Del All**, you will hear a beep and the phone returns to standby mode after clearing all of the records.

Storing Caller List Records

1. Press  under the word **Menu** on the screen to display the main menu list.
2. Press  under the word **Select** to select Call List.
3. Press up  or down  to locate the desired record and press  under the word **More**.
4. Press  under the word **Select** to select **Add to PB**.
5. The current name will be displayed. If necessary, press  under the word **Erase** to clear the name and then enter the desired name and press  under the word **Save**.
6. The current number will be displayed. If necessary, press  under the word **Erase** to clear the digit(s) and then enter the desired number and press  under the word **Save**.
7. Press up  or down  to select the Melody ring you would like to associate with the number, and then press  under the word **Select**.
8. Repeat if necessary.

PHONEBOOK OPERATION

Reminder: Press  under the word **Back** on the screen from any menu to return to the previous screen. To return to the main screen, press . Otherwise, after 30 seconds, the phone will automatically return to the main screen from any menu if no key is pressed.

The built-in phonebook allows you to store frequently used numbers so that you can easily make a call without having to remember or enter the phone number. You can store up to 50 numbers in the phonebook.

Character Map











To enter a specific alphanumeric character, press the relevant key one or more times for the required character according to the following table: once for the first character, twice for the second and so on.



Clarification:

When entering the same letter twice or a different letter with same key, wait for a few seconds for the cursor to move automatically and then select the next letter.

Key	Characters in the displayed order								
0	(spc)	0	?	&	/	.	,	!	
1	1	@	_	+	-	"	()	%
2	A	B	C	a	b	c	2		
3	D	E	F	d	e	f	3		
4	G	H	I	g	h	i	4		
5	J	K	L	j	k	l	5		
6	M	N	O	m	n	o	6		
7	P	Q	R	S	p	q	r	s	7
8	T	U	V	t	u	v	8		
9	W	X	Y	Z	w	x	y	z	9

■ Adding Phonebook Entries



1. Press  under the word **Menu** on the screen to display the main menu list.
2. Press down  to choose **Phonebook** and then press  under the word **Select**.
3. The display shows the first entry already in the Phonebook.
4. Press  under the word **Select** and the display shows **"Add"**. Press  under the word **Select**.
5. The display shows **"Name?"**. Enter the name you want to use and then press  under the word **Save**. The display shows **"Number?"**. Enter the desired number (up to 24 digits) and then press  under the word **Save**.
6. Press up  or down  to select from **Melody 1 – Melody 10** and then press  under the word **Select**. If you want to set a VIP number, you should select a special Melody ring tone for it. This ring tone should be different than the EXT Ring tone you have set.
7. Repeat if necessary.

Note: If you make a mistake while entering a name or a number, press  under the word **Erase** to correct it. Each time you press this key, the last digit is deleted. To clear all digits, press and hold  under the word **Erase**.







■ Using a Pause

(used when entering a phonebook entry or **M1-M4** memory dial entry) You can insert one 3 second pause into dialing or memory storage in order to access custom and telebanking services, long distance, calling cards, etc. Press right  on the navigation key at the desired point in the number to insert the pause and the letter **P** will appear at the pause entry.

■ Viewing Phonebook Entries















1. In standby mode, press down  to enter the phonebook.
2. Press up  or down  to scroll through the list until the desired entry is displayed.

■ Dialing a Number from the Phonebook

1. In standby mode, press down  to enter the phonebook.
2. Press up  or down  to scroll through the list until the desired entry is displayed. You can also press the first letter of the contact name using the keypad and the LCD will display the corresponding section of your phonebook and you can press up  or down  to find the desired entry.
3. Press  or press  under the word **Dial**.













■ Using Phonebook Options

Editing (name, number, ring tone)

1. Press  under the word **Menu** on the screen to display the main menu list.
2. Press down  to select **Phonebook** and then press  under the word **Select**.
3. Press up  or down  repeatedly until the entry you want to edit displays, and then press  under the word **Select**.
4. Press down  to select **Edit** and then press  under the word **Select**.
5. The current name will be displayed. If necessary, press  under the word **Erase** to clear the name and then enter the desired name and press  under the word **Save**.
6. The current number will be displayed. If necessary, press  under the word **Erase** to clear the digit(s) and then enter the desired number and press  under the word **Save**.
7. Press up  or down  to select the Melody ring you would like to associate with the number, and then press  under the word **Select**.
8. Repeat if necessary.







Deleting

Note: If you choose **Delete All**, all of your phonebook entries will be deleted.

1. Press  under the word **Menu** on the screen to display the main menu list.
2. Press down  to select **Phonebook** and then press  under the word **Select**.
3. Press up  or down  repeatedly until the entry you want to delete displays, and then press  under the word **Select**.
4. Press up  or down  to scroll to **Delete** and then press  under the word **Select**. The entry will be deleted and the display will show the next entry.
5. At step 4, if you choose the **Delete All** menu and press  under the word **Select**, the display will show **"Repeat"**. You can press  under the word **Select** to delete all the entries or press  under the word **Back** to exit.



PB (Phonebook) Status

The PB (Phonebook) status shows the number of phonebook entries already stored. To review the PB Status:

1. Press  under the word **Menu** on the screen to display the main menu list.
2. Press down  to select **Phonebook** and then press  under the word **Select**.
3. Press up  or down  to scroll to **PB Status** and then press  under the word **Select** to view the Phonebook status.

ADDITIONAL FUNCTIONS





Paging

You can page the handset from the base unit to help locate the handset. Press  on the base (hold for less than 5 seconds) and all of the handsets registered to the base will ring for about 1 minute. To stop paging, press  on the base again or press any key on the handset.

Note: If you hold  for more than 5 seconds, the base will enter registration mode.

Key Lock









You can lock all keys on the keypad except for the **M1 – M4** memory dial keys. While in locked mode, the handset still can be answered by pressing . When you hang up, the handset will return to the locked mode.







To lock the keypad, in standby mode, press and hold  until the  icon appears. To unlock the keypad, press and hold  until the  icon disappears.

While in locked mode, if you press any key, the phone will generate a warning tone.

Alarm

You can set an alarm on the handset (the alarm also supports the snooze function). To set the alarm:

1. Press  under the word **Menu** on the screen to display the main menu list.
2. Press up  or down  to scroll to **HS Settings** and then press  under the word **Select**.
3. Press  under the word **Select** to select **Alarm** and the display will show the current set-up.
4. Press up  or down  to select **On** or **Off** and then press  under the word **Select**. If you select **On**, the display asks you to enter the time in **HH:MM**.

5. Use the keypad to enter the time (If your time is set to the **12 – Hour** format, you will still need to enter the time in the **24 – Hour** format. Press  under the word **Select**.
6. The display shows **Snooze**. Press  under the word **Select** to turn Snooze On or Off.
7. Press up  or down  to select **On** or **Off** and then press  under the word **Select**.
8. When the alarm sounds, press any key to switch it off. If you have selected Snooze **On**, the alarm will ring every 11 minutes. To stop the snooze alarm, you must press  to prevent the snooze function from continuing. This automatically switches the Snooze function to Snooze **Off**. You will need to re-select Snooze **On** if you want to turn that function back on for the next time the alarm is set to go off.



■ Torch

If you turn this feature on, the visual phone ringer light will remain lit and can be used as a light. To turn this feature on/off, in standby mode, press and hold  until the light turns on/off.

SETTING UP YOUR ANSWERING MACHINE

TELEPHONE ANSWERING MACHINE (TAM) OPERATION

Speakerphone Reminder: Press  under the word **Back** from any menu to return to the previous screen. Otherwise, after 20 seconds, the phone will automatically return to the main screen from any menu if no key is pressed.









Handset Reminder: Press  under the word **Back** from any menu to return to the previous screen. To return to the main screen, press . Otherwise, after 30 seconds, the phone will automatically return to the main screen from any menu if no key is pressed.

The answering machine will hold up to 15 minutes of messages and can be accessed from the phone or from a remote location.







■ Turn On/Off

This section shows you how to set up your answering machine to receive incoming calls. Before you begin the set up process, you must turn on the answering machine. To set this feature:

Using the Base

1. Press  under the word **Menu** on the screen to display the main menu list.
2. Press  or  to scroll to **TAM setup** and then press  under the word **Select**.
3. Press  under the word **Select** to access **TAM ON/OFF**.
4. Press  or  to choose between ON/OFF to and then press  under the word **Select**.

Using the Handset











1. Press  under the word **TAM** to display the TAM main menu list.
2. Press up  or down  to scroll to **TAM On/Off** and then press  under the word **Select**.
3. Press up  or down  to select **Off** or **On** and then press  under the word **Select**.

■ TAM Settings











Rings to Answer

This is the number of rings after the answering machine takes an incoming call and plays your outgoing message. You can select from 2 to 6 rings or toll saver mode. If you select **Toll Saver**, the unit answers after the 2nd ring if there are new messages waiting or after the 6th ring if there are no new messages waiting. To change the ring number:

Using the Base:











1. Press  under the word **Menu** on the screen to display the main menu list.
2. Press  or  to scroll to **TAM setup** and then press  under the word **Select**.
3. Press  or  to choose **Ring number** and then press  under the word **Select**.
4. Press  or  to choose the answer rings (**2, 4, 6, 8 Rings** or **toll saver**) and then press  under the word **Select**.

Using the Handset:

1. Press  under the word **TAM** to display the TAM main menu list.
2. Press up  or down  to scroll to **TAM Settings** and then press  under the word **Select**.
3. Press up  or down  to scroll to **Set Ring** and then press  under the word **Select**.
4. Press up  or down  to select the answer rings (**2, 4, 6, 8 Rings** or **Time Saver**) and then press  under the word **Select**.

Record Time











Using the handset, you are able to select the recording time limit for messages. You can select from 1 minute, 120 seconds, 180 seconds or unlimited. If you select **unlimited**, the message can continue to be recorded until the memory is full. To select the record time:

1. Press  under the word **TAM** to display the TAM main menu list.
2. Press up  or down  to scroll to **TAM Settings** and then press  under the word **Select**.
3. Press up  or down  to select **Record Time** and then press  under the word **Select**.
4. Press up  or down  to select the record time (**60S**, **120S**, **180S** or **Unlimited**) and then press  under the word **Select**.

Voice Prompt Language (announces answering machine functions)









The handset supports 3 predefined languages: English, French & Spanish. You can change the language used to play the voice prompt messages. To change the language:

Using the Handset:

1. Press  under the word **TAM** to display the TAM main menu list.
2. Press up  or down  to scroll to **TAM Settings** and then press  under the word **Select**.
3. Press up  or down  to select **TAM Language** and then press  under the word **Select**.
4. The current language will be displayed. Press up  or down  to scroll through the language options. Press  under the word **Select** to choose the desired language.

Answer Mode Selection

The answering machine offers 2 modes for operation. **ANS & REC** will answer and record, which is the conventional outgoing message that allows the caller to leave a message. **Answer only** will answer only, which is the outgoing message that does not allow a caller to leave a message (you may want to select **Answer only** if you do not want callers to be able to leave a message). To choose the Answer Mode, you must use the handset.

1. Press  under the word **TAM** to display the TAM main menu list.
2. Press up  or down  to scroll to **TAM Settings** and then press  under the word **Select**.
3. Press  under the word **Select** to choose **Answer Mode**.
4. Press up  or down  to select **ANS & REC** or **Answer Only** and then press  under the word **Select**.

Note: The **Answer only** message will be played if your answering machine becomes full.











Recording Outgoing Message

(each message can be up to 1 minute)









Using the Handset to record "ANS & REC":

The default announcement is "***Please leave your message after the tone.***"

To change the message:

1. Press  under the word **TAM** to display the TAM main menu list.
2. Press up  or down  to scroll to **TAM Settings** and then press  under the word **Select**.
3. Press down  to select **Announce** and then press  under the word **Select**.
4. Press  under the word **Select** to select **ANS & REC**.
5. Press down  to select **Record MESS** and then press  under the word **Select**.
6. Record your announcement after the tone. Recording will stop automatically after 1 minute or you can confirm and end the recording by pressing  under the word **Select**. During the recording, the LCD will show "**Recording**".
7. The announcement will be played back immediately. If you do not like your message, record your announcement again or restore it to the default one.

Using the base to record "ANS & REC" (called Recorded OGM):











1. Press  under the word **Menu** on the screen to display the main menu list.
2. Press  to scroll to **TAM setup** and then press  under the word **Select**.
3. Press  to choose **Outgoing Msg** and then press  under the word **Select**.
4. Press  to choose **Record OGM** and then press  under the word **Select**. Speak clearly into the microphone, which is located below the Redial button. The display will show "Recording".
5. You can record your OGM after the tone. Recording will stop automatically after 1 minute. You can also confirm and end the recording by pressing  under the word **End**. The new OGM will be played after the recording.

Sample ANS & REC message:

Hi, this is (use your name here), I can't answer the phone right now so please leave your name, number and a brief message after the tone and I'll get back to you. Thank you.

Using the Handset to record "Answer only":











The default announcement is "Hello, your call cannot be taken at the moment. Please call back later." To change the message:

1. Press  under the word **TAM** to display the TAM main menu list.
2. Press up  or down  to scroll to **TAM Settings** and then press  under the word **Select**.
3. Press down  to select **Announce** and then press  under the word **Select**.
4. Press  under the word **Select** to select **Answer Only**.
5. Press down  to select **Record MESS** and then press  under the word **Select**.
6. Record your announcement after the tone. Recording will stop automatically after 1 minute or you can confirm and end the recording by pressing  under the word **Select**. During the recording, the LCD will show "Recording..."







7. The announcement will be played back immediately. If you do not like your message, record your announcement again or restore it to the default one.

Play Announcement









Method 1: Using the Handset

1. Press  under the word **TAM** to display the TAM main menu list.
2. Press up  or down  to scroll to **TAM Settings** and then press  under the word **Select**.
3. Press down  to select **Announce** and then press  under the word **Select**.
4. Press  under the word **Select** to select the message you want to play (**ANS & REC** or **Answer Only**).
5. Press  under the word **Select** to choose **Playback**.
6. Press  under the word **Select** to choose **Playback**.
7. The current announcement will play. During the playback, the display shows "**Playing OGM.**" You can press  under the word **Back** to stop and exit.

Method 2: Using the Base



1. Press  under the word **Menu** on the screen to display the main menu list.
2. Press  to scroll to **TAM setup** and then press  under the word **Select**.
3. Press  to choose **Outgoing Msg** and then press  under the word **Select**.
4. Press  under the word **Select** to choose **Play OGM**.
5. The current OGM will be played. During the process the display will show **Playing**. You can press  under the word **End** to stop and exit.
6. If you do not like your message, record your message again or restore it to the default one.

Restore Default Announcement(s)



1. You must use the base to restore the default announcement(s).
2. Press  under the word **Menu** on the screen to display the main menu list.
3. Press  or  to scroll to **TAM setup** and then press  under the word **Select**.
4. Press  to choose **Outgoing Msg** and then press  under the word **Select**.
5. Press  or  to choose **Erase OGM** and then press  under the word **Select**.
6. You will hear a confirmation beep and the recorded OGM is now deleted and the original default message returns.

■ **Message Options**

Answering Machine Volume

When listening to your messages through the base, adjust the volume by using the Volume Control **V-** or **V+** on the right side of the phone. When listening to your messages through the handset, adjust the volume by using the Vol+ or Vol- keys on the left side of the handset or up  or down  on the navigation key.

Screening Calls (only the handset can intercept the call)

1. When the answering machine answers the call, listen while the caller leaves a message.
2. To speak to the caller, pick up the handset and press 
(If you have Auto Answer ON and your phone is in the base, you will still need to press  after picking up the handset).

The answering machine automatically stops recording when you activate the handset.







TIP: Make sure the volume on the phone is set loud enough to hear your incoming callers.



Play Messages

When a call is received and the TAM is ON and **ANS & REC** is selected, the machine will play the outgoing message, and then perform message recording. The process is as follows:

After ringing **N** times, the phone enters answer-record mode automatically and starts to play the outgoing message. The caller can record after the tone.

Using the Handset:

1. Press  under the word **TAM** to display the TAM main menu list.
2. Press  under the word **Select** to select **MSG Playback**.
3. The phone will announce “**You have N new message(s)**” or “**You have N saved message(s)**”. The messages will be played back and you can:
 4. press  to delete the current message while it is playing
 5. press  to pause/play the current message
 6. press  once to replay the current message and twice to replay the previous message
 7. press  to skip to the next message
 8. press  under the word **Back** to stop playing and exit

Please Note: When listening to your messages through the handset, the message will always start playing back through the handset speakerphone. To switch to the earpiece, press . You can switch between speakerphone and handset while listening to messages by pressing .

Method 2: Using the Base



Play/Stop Key

Press to start or stop the Message or Memo playing



Skip Key

Press to play the next message



Repeat Key

Press once to play the current message
Press twice to play the previous message



Delete Key

While playing an incoming message, press and hold this key to delete the current message.
When the answering machine is ON, press and hold this key to delete all of the messages.







Memo Key



Press and hold this key to record a memo (it will be stored as a new message)

Delete Messages

Using the Handset (can only delete ALL messages):











1. Press  under the word **TAM** to display the TAM main menu list.
2. Press down  to select **Delete All** and then press  under the word **Select**.
3. The LCD will show "**Confirm ?**" Press  under the word **OK** to delete all messages or press  under the word **Back** to cancel and exit.

Method 2: Using the Base (can delete all or specific messages)

While playing an incoming message, press and hold the  key to delete the current message. Making sure the answering machine is ON, press and hold the  key to delete all of the messages.

■ Message Playback Speed

You can slow down the playback speed of Incoming Messages (ICM). To change this setting (through the base only):

1. Press  under the word **Menu** on the screen to display the main menu list.
2. Press  or  to scroll to **TAM setup** and then press  under the word **Select**.
3. Press  or  to choose **ICM Voice Slow** and then press  under the word **Select**.
4. Press  or  to choose **On** or **Off** and then press  under the word **Save**.





■ Record A Memo

You can use the phone to record memo messages (each can be up to 3 minutes). A memo can be useful as a short message to another person in the household or as a personal reminder. This memo will be played as a message.

Using the Base:

1. Press and hold the **MEMO** key in standby mode. The display will show **Recording Memo** and the recording will start. Important: The **MEMO** key should be pressed and held during the whole process.
2. Release the **MEMO** key to end the recording.

Using the Handset:

1. Press  under the word **TAM** to display the TAM main menu list.
2. Press up  or down  to select **Memo** and then press  under the word **Select**.
3. Begin recording your announcement. Recording will stop automatically after 3 minutes or you can confirm and end the recording by pressing  under the word **OK**. During the recording, the LCD will show "**Recording**".









When a Memo is recorded,  will appear on the LCD and you can play the memo message back as you would play answering machine messages back.

■ Security ID/PIN & Remote Access









Security ID/PIN

To operate your answering machine remotely, you will need to enter the Security ID/PIN. For security reasons, you should change this code (the default one is 0000): For more details on how to use remote access, please refer to **Remote Access** listed below. To change your Security ID/PIN:

Using the Base:

1. Press  under the word **Menu** on the screen to display the main menu list.
2. Press  or  to scroll to **TAM setup** and then press  under the word **Select**.
3. Press  or  to choose **Security ID** and then press  under the word **Select**.
4. The display shows the current security ID. Enter the new one you want to use and then press  under the word **Save**.

Using the Handset:

1. Press  under the word **TAM** to display the TAM main menu list.
2. Press up  or down  to scroll to **TAM Settings** and then press  under the word **Select**.
3. Press up  or down  to scroll to **Change PIN** and then press  under the word **Select**.
4. Enter the current code and then press  under the word **OK**.
5. Enter the new code twice you would like to set up (should enter twice) and then press  under the word **OK**.

Remote Access

You can access many features of your answering machine remotely from any touch tone phone. A four-digit Security ID/PIN is required to access the system and the factory default code is 0000. To enter remote access:

Dial your phone number from any touch tone phone. When the Announce1/Announce2 message starts to play, you may enter the remote access mode by inputting a  and then the Security ID/PIN. If you enter the ID/PIN incorrectly, the machine will ask you to enter the ID/PIN again. You are given 2 more attempts to correctly enter the ID/PIN before the line is disconnected. After you enter the ID/PIN, the system will play the menu of commands. You can then follow the commands to operate.

Note: It is best to stop playing messages before hanging up the phone.

Reminder: Your answering machine must be turned ON in order to use remote access.

TROUBLESHOOTING

No dial tone

1. Check that all phone cord connections and AC adapter are securely plugged into the phone, wall jack and electric outlet.
2. Check that the handset batteries are installed properly and are in full power (page 19).
3. Check that the phone is in the correct dialing mode: tone or pulse (page 30 or 52).
4. Plug another phone into the wall jack to make sure your phone service is working.

Nothing appears on the display

1. Check that the handset batteries are installed properly and are in full power.

2. Check that the handset has been turned on (page 58).

Handset seems to have a short battery life

1. Check the charging contacts.
2. Make sure you have installed the correct batteries (Never use alkaline batteries! Only AAA NiMH rechargeable batteries should be used).
3. Consistently short battery life may indicate that the batteries need to be replaced.

No audible ringer

1. Make sure the ringer is not turned off.
(pages 28-29, 56-57)
2. Check the volume level of the ringer.
(pages 28-29, 56-57)
3. Verify the AC adapter is securely plugged into the AC outlet and phone.
4. You may have too many extensions on your line. Try unplugging a few a devices.

Visual ringer and vibrating handset will not activate

1. Make sure the visual ringer and vibrating handset function is turned ON (page 57).

No amplification

1. Check to see if the Amplify button is ON. The red light should be lit (page 35, 61).
2. The AC adapter is required; make sure the AC adapter is plugged into the wall and into appropriate jack on the phone.

Low handset or speaker volume

1. Check the receiver or speaker volume settings.
(page 35-36, 61-62)
2. Can't be heard by other party
3. Check that all phone cord connections are securely plugged into the phone and wall jack.

Noise, Static, Interference while using the phone

1. A filter may be required for your home when you have DSL service or live near radio towers.
2. Make sure the AC adapter is not plugged into the wall outlet with other appliances.
3. Try relocating the phone to another location.

No numbers dialed when memory button is pressed

1. No number stored in that memory button.
(page 37-38, 65)
2. Make sure phone number was programmed and saved.
(page 37-38, 65)
3. Make sure programming is done in the correct dialing mode (touch-tone or pulse).

Caller ID information does not show

1. Make sure you are subscribed to Caller ID service through your local phone company.
2. Let the phone ring a couple of times as there may be a delay in receiving the Caller ID information.

No Caller ID information while on a call

1. Make sure your service provides Caller ID information while you are on a call. This is sometimes known as "Caller ID on Call Waiting" or "Type II Caller ID".
2. The phone cannot display the information if another phone on the same line is in use.

Answering Machine Tips

1. If you can't hear the messages, or button tones, adjust the volume (page 83).
2. If the system always plays Announce2, the message memory may be full. Erase some messages.
3. If the incoming messages are incomplete, the message memory is full. Erase some messages.

TECHNICAL SPECIFICATIONS

General Number: A1600
Amplification: 125dB SPL

Power Requirements:

Base Input: 120 ~ 240VAC 50/60 HZ 150mA
Handset Input: Ni-MH 1.2V x 3, mAh
Charging Time: 15 hours

Jack: 2.5 mm headset
3.5 mm audio

Features and Specifications subject to change without notice.

Purchase accessories for Your ClearSounds Phone:

Optional Neckloop: CS-CLA7V2 (connects easily to your phone's 2.5mm Phone Headset jack for hands-free conversations). Requires hearing aid(s) or cochlear implant(s) with t-coil(s).



Optional Headset: CS-900HS (connects easily to your phone's 2.5mm Phone Headset jack for hands-free conversations).



**To learn more, call ClearSounds at 1-800-965-9043
or visit www.clearsounds.com**

FCC WANTS YOU TO KNOW

1. This equipment complies with Part 68 of the FCC rules and the requirements adopted by the ACTA. On the bottom of this equipment is a label that contains, among other information, a product identifier of [US: CLSTE12B]. If requested, this number must be provided to the phone company.
2. If the ClearSounds® A1600 DECT 6.0 Amplified Freedom Phone™ with Full ClearDigital Power™ causes harm to the phone network, the phone company will notify you in advance that temporary discontinuance of service may be required. But if advance notice isn't practical, the phone company will notify the customer as soon as possible. Also, you will be advised of your right to file a complaint with the FCC if you believe it is necessary.
3. The phone company may make changes in its facilities, equipment, operations or procedures that could affect the operation of the equipment. If this happens the phone company will provide advance notice in order for you to make necessary modification to maintain uninterrupted service.
4. If you experience trouble with this equipment, you should disconnect it from the network until the problem has been corrected or until you are sure that the equipment is not malfunctioning.
5. Please follow instructions for repairing if any (e.g. battery replacement section); otherwise do not alternate or repair any parts of device except as specified.
6. Connection to party line service is subject to state tariffs. Contact the state public utility commission, public service commission or corporation commission for information.

7. If the phone company requests information on what equipment is connected to their lines, inform them of:
- a) The phone number that this unit is connected to,
 - b) The ringer equivalence number [1.2B]
 - c) The USOC jack required [RJ11C], and
 - d) The FCC Registration Number [US:]

Items (b) and (d) are indicated on the label. The ringer equivalence number (REN) is used to determine how many devices can be connected to your phone line. In most areas, the sum of the RENs of all devices on any one line should not exceed five (5.0). If too many devices are attached, they may not ring properly.

Service Requirements

In the event of equipment malfunction, all repairs should be performed by our Company or an authorized agent. It is the responsibility of users requiring service to report the need for service to our Company or to one of our authorized agents. Service can be facilitated through our office at:

ClearSounds Communications, Inc.
1743 Quincy Avenue, Suite 155 Naperville, IL 60540 U.S.A

INDUSTRY CANADA CS03 STATEMENT

This product meets the applicable Industry Canada technical specification. This is confirmed by the registration number. The abbreviation, IC before the registration number signifies that registration was performed based on a Declaration of Conformity indicating that Industry Canada technical specifications were met. It does not imply that Industry Canada approved the equipment.

Before installing this equipment, users should ensure that it is permissible to be connected to the facilities of the local telecommunications company. The equipment must also be installed using an acceptable method of connections. The customer should be aware that compliance with the above conditions may not prevent degradation of service in some situations.

Repairs to certified equipment should be made by an authorized Canadian maintenance facility designated by the supplier. Any repairs or alterations made by the user of this equipment, or equipment malfunctions, may give the telecommunication company cause to request the user to disconnect the equipment.

WARNING! Users should not attempt to make such connections themselves, but should contact the appropriate electric inspection authority, or an electrician, as appropriate.

CAUTION: The Ringer Equivalence Number (REN) assigned to each terminal device provides an indication of the maximum number of terminals allowed to be connected to a phone interface.

The termination on an interface may consist of any combination of devices subject only to the requirement that the sum of the Ringer Equivalence Numbers of all the devices does not exceed 5. An alternative indication of the REN is the Load Number (LN); this number should be divided by 20 to approximate the equivalent REN. The REN Number of this unit is indicated on the bottom of your phone.

If your home has specially wired alarm equipment connected to the phone line, ensure the installation of the A1600 does not disable alarm equipment. If you have questions about what will disable alarm equipment, consult your phone provider or a qualified installer.

This Class B digital apparatus complies with Canadian ICES-003.

LIMITED ONE-YEAR WARRANTY

The product is warranted by ClearSounds against manufacturing defect in material and workmanship under normal use for one (1) year from the date of purchase. Should you experience a problem, contact our customer service department or visit our website at www.clearsounds.com.

Be sure to save your sale receipt as the proof of purchase date should you need warranty service.

Your Phone comes with a (1) year limited warranty from the date of purchase. This product is warranted by ClearSounds against manufacturing defect in material and workmanship under normal use. In the event that this product fails to function properly within one year of the original purchase due to defects in materials or workmanship, return the unit (freight prepaid) with proof of purchase (sales receipt or packing slip, no exceptions) to ClearSounds Communications. ClearSounds Communications will either repair or replace the unit (with a refurbished unit or unit of equal condition) and return it you (using UPS/USPS ground shipping) at no cost to you. The warranty replacement or repair will be warranted for a period of 90 days or the remainder of the original warranty period (from original purchase date); whichever is longer.

The warranty does not cover accidents, negligence or breakage to any parts. This includes shipping damage, failure to follow instructions, misuse, fire, floods, use of incompatible accessories, Acts of God or failure in your phone service carrier's line service. The product must not be tampered with or taken apart by anyone who is not an authorized ClearSounds Communications® representative. Tampering with the phone will void any written or implied warranties.

If a defect covered by this warranty should occur, promptly contact a Customer Service Representative by phone or log onto www.clearsounds.com to obtain a Return Merchandise

Authorization number and shipping instructions before shipping the product to us. Any shipment without a (RMA) Return Merchandise Authorization number will not be accepted and will be returned to you at your expense. All authorized returned products must be accompanied with proof of purchase and a brief explanation of the problem.

For out of warranty repairs and service, please contact our Customer Service Department for instructions. The repair shall be warranted for 90 days.

IMPORTANT: YOUR RECEIPT IS PART OF YOUR WARRANTY AND MUST BE RETAINED AND PRODUCED IN THE EVENT OF A WARRANTY CLAIM.

Service in United States and Canada, contact:

ClearSounds Communications
Attention: Repair Center
1743 Quincy Avenue, Suite 155
Naperville, IL 60540
USA
800-965-9043

Check our website www.clearsounds.com for additional information and to download additional manuals and information.

Free Manuals Download Website

<http://myh66.com>

<http://usermanuals.us>

<http://www.somanuals.com>

<http://www.4manuals.cc>

<http://www.manual-lib.com>

<http://www.404manual.com>

<http://www.luxmanual.com>

<http://aubethermostatmanual.com>

Golf course search by state

<http://golfingnear.com>

Email search by domain

<http://emailbydomain.com>

Auto manuals search

<http://auto.somanuals.com>

TV manuals search

<http://tv.somanuals.com>