

CLIFFORD

THE SCIENCE OF SECURITY™

[OWNER'S GUIDE]

M O D E L
420.4X

Congratulations

Congratulations on the purchase of your state-of-the-art remote start and keyless entry system. Reading this Owner's Guide prior to using your system will help maximize the use of your system and its many features. For more information please visit the below website:

<http://www.clifford.com> – For general and additional guide information.

For any additional questions please contact your authorized Directed dealer or contact Directed at **1-800-753-0600**. (U.S. only)

What you get

Welcome to the best generation of keyless entry with remote start. Your system contains everything you need.

- One Responder LE 2-way SuperCode remote control
- 1-way companion remote
- Owner's guide
- Warranty card

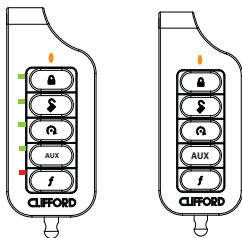

Important information

Government Regulations and Safety information



Read the *Government Regulations* and *Warning! Safety First* sections of this manual prior to operating this system.

Warning! Failure to heed this information can result in death, personal injury or property damage and may also result in the illegal use of the system beyond its intended purpose.

Your Warranty

Your system comes with a warranty. Please make sure you receive the warranty registration card and proof of purchase from your dealer indicating the product was installed by an authorized Directed dealer. You can validate it online at www.prodregister.com/directed or complete and return the warranty registration card.

Replacement remote controls

Your system comes with one Responder LE remote control (P/N 7251X) and a 1-way companion remote (P/N 7152X). If additional remotes are desired, please see your authorized dealer or visit us at www.directedstore.com to order.

Contents

Getting Started.....	3
Keys to using this manual.....	3
Remote Control Information.....	4
Control Center.....	5
Using your System.....	6
Commanding the system.....	6
Performing Commands.....	6
Remote Control Command table.....	7
Basic Commands (Direct Access).....	8
Lock.....	8
Unlock.....	8
Remote Start.....	8
AUX/Trunk.....	9
Advanced Commands: (Level 1).....	9
Silent Lock.....	9
Runtime Reset.....	10
AUX 1.....	10
Temperature Request.....	10
Advanced Commands: (Level 2).....	10
Remote Valet.....	11
Timer Start.....	11
AUX 2.....	11
Advanced Commands: (Level 3).....	12
Car finder.....	12
Smart Start.....	12
AUX 3.....	12
Runtime Remaining.....	12
Advanced Commands: (Level 4).....	13
Defogger.....	13
AUX 4.....	13
Remote Control Configuration.....	14
Remote Programming.....	14
Remote Pairing.....	14
Remote Features.....	15
Keypad Lock.....	16
Page Mode.....	17
Car 2.....	17
Remote Beep.....	17
Emergency Override.....	18
Remote Start Features.....	19
Pit Stop Mode.....	19
Key Takeover.....	19

Remote Start Safe-lock	20
Disabling Remote Start	20
Advanced Start	20
Temperature Reporting.....	21
Remote Start Time-out Alert.....	21
Manual Transmission Start (MTS mode)	22
Turbo Timer Mode.....	23
Remote Start Faults.....	24
Remote and System Operations.....	25
Passive Locking	25
Auto Re-locking	25
Valet Mode	26
Power Save.....	26
Rapid Resume	26
Automatic Remote Updates	26
Car Select.....	27
System Expansion Options.....	28
Battery Information.....	29
Low Battery	29
Low Battery Alerts	29
Battery Life.....	29
Battery Replacement.....	30
Battery Disposal	30
Glossary of Terms.....	31
Government Regulations	32
Warning! Safety First.....	33
Installation	33
Remote Start Capable	33
Manual Transmission Vehicles	33
Interference.....	35
Upgrades	35
Water/Heat Resistance	35

Getting Started

Keys to using this manual

Specific actions (in bold type) and style conventions are used consistently throughout this manual, they are as follows:

- **Press:** implies pushing in and releasing a button.
- **Hold:** is used after Press actions when a button needs to be held in position for an extended period of time, typically several seconds.
- *Italicized* words denote section/sub headings in this guide and can be located through the table of contents.
- An asterisk (*) when used after a word or phrase denotes that additional details can be found in related sections usually noted at the bottom of the page or end of the section.

Remote Control Information

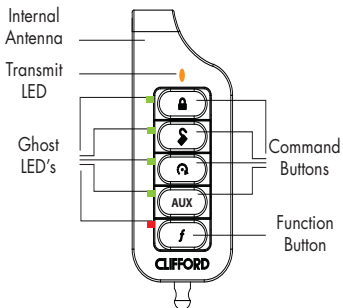

Feature	Description
Internal Antenna	Used for transmitting and receiving*information
Command buttons (4)	Used to perform locking, unlocking, auxiliary channel and remote start commands
Function button	Used to access function levels for commands, configuration menus for programming, Car Selection, and to request reports.
Ghost LED's**	Each button has an associated LED next to it that are active during related operations. These LED's are labeled respectively as: Lock LED, Unlock LED, Remote Start LED, Aux LED, and f LED

*2-way communication is only applicable to the Responder LE remote control

** Term denotes that these LED's are only visible when On (Ghost LED's are only applicable to the Responder LE remote control).

Control Center

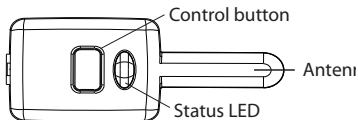

The Control Center, typically located on the upper part of the front windshield. It consists of:

- The In-vehicle system antenna.
- The Status LED, as a visual indicator of the system's status.
- The Control button, for placing the system into Valet Mode* and to perform the Emergency Override operation.

* See *"Remote and System Operations"* on page 25.

Using your System

Commanding the system

Commands, Basic or Advanced, are used to activate system features and are performed by pressing one of the Command buttons. Basic commands control the most often used keyless entry and remote start features while Advanced commands control more specialized features.

Confirmations for Basic or Advanced commands are indicated by horn honks* and parking light flashes. A description of each feature confirmation is found in the following Basic command and Advanced command sections.

Performing Commands

Perform Basic commands by pressing a Command button.



Perform Advanced Commands by first accessing Levels 1-4 using the **f** button and then by pressing a Command button while within a level.

Advanced command example: Silent Lock

1. Press the **f** button once to access Function Level 1, The transmit LED single flashes for 3 seconds.
2. Press the  button while the transmit LED is still flashing to perform the Silent Lock command.
3. The system will lock the doors and flash the parking lights, without horn honks.*

* The optional Horn Honk feature must be connected.

Remote Control Command table

Basic Commands		Advanced Commands			
Level Button	Direct Access	f x 1	f x 2	f x 3	f x 4
	Lock	Silent Lock			
	Unlock	Silent Unlock	Valet Mode	Car Finder	
	Remote Start	Reset Runtime	Timer Mode	Smart Start	Rear Defogger
AUX	Trunk Release	AUX 1	AUX 2	AUX 3	AUX 4
f	Function Shift	Cabin Temp. Request (2- way only)	Lock Status (2- way only)	Runtime Check (2- way only)	

Basic Commands (Direct Access)



Lock

Press and release ,

Doors lock (if connected). The horn honks once, and the parking lights flash one-time. Lock LED turns on with 1 beep.

To Lock and Panic

Press and **hold** 

To lock the system, then activate Panic. For Panic to work the optional horn honk feature must be connected. **Press** the  or  button to stop Panic output.

Unlock

Press and release .

The doors unlock (if connected).

The horn honks twice and the parking lights flash. Unlock LED turns on and remote beeps twice.

Remote Start*

Press and release .

Activates (or if On, deactivates) the remote starter. The engine turns On, or the engine turns Off accordingly. The parking lights flash. Remote Start LED turns on, and plays tones.

If a Remote start configuration issue prevents the engine from starting, the parking lights flash a Remote Start fault report to identify the fault.

AUX/Trunk**

Press and hold **AUX**.

The AUX LED turns on and tones play to confirm. The Trunk opens (if connected) when this button is pressed for 2 seconds.

* For Manual transmission vehicles see "Manual Transmission Start (MTS mode)" on page 22 in the "Remote Start Features" section for more details.

**This is an optional feature. See your authorized Directed dealer for details.

Advanced Commands: (Level 1)

Press and release the **f** button 1 time. The transmit LED illuminates in sets of single flashes to indicate Level 1.

Silent Lock

Press and release 

The doors lock (if connected), without horn honks. * The Lock LED turns on to confirm.

Silent Unlock

Press and release 

Doors unlock (if connected), without horn honks. The parking lights flash twice. The Unlock LED turns on to confirm.

Runtime Reset

Press and release 

If more time is needed while remote start is active, runtime reset will reset the runtime counter to the pre-programmed setting. The green ghost LED's show the runtime and the remote start On tones play to confirm runtime reset.

Note Remote Start must be On to use this feature.

AUX 1

Press and release **AUX**

Activates (or if On, deactivates) the Aux 1 output. The AUX LED turns on and tones play to confirm.

Temperature Request

Press and hold the **f** button

Requests the vehicle's interior temperature and displays it by illuminating the green ghost LED's; cold is 1 LED, cool (2), warm (3), warmer (4)

* The optional Horn Honk feature must be connected.

Advanced Commands: (Level 2)

Press and release the **f** button 2 times. The transmit LED illuminates in sets of double flashes to indicate Level 2.

Remote Valet

Press and release



Enters (or if On, exits) Valet Mode. The Control Center LED turns on and off accordingly, and prevents doors from locking passively. The The Unlock LED and Valet beeps play (1 for on, 2 for off) to confirm.

Timer Start*

Press and release



Activates (or if On, deactivates) Timer Start. The parking lights flash quickly four times for On and slowly four times for Off. The Remote Start LED and beeps play (1 for on, 2 for off) to confirm.

Note

System needs to be locked or Timer Start will not start the engine.

AUX 2

Press and release **AUX**

Activates (or if On, deactivates) the Aux 2 output. The Aux LED and On tones or Off tones play to confirm.

Lock Status

Press and hold the **f** button.

The remote will generate an output using the LED's and beeps/tones to display the systems Lock Status since its last update message or command operation. It will report status via ghost LED's, beeps, and tones as described in this section for Lock, Unlock, Valet mode and Silent lock.

*See "Advanced Start" under "Remote Start Features" for more details.

Advanced Commands: (Level 3)

Press and release the **f** button 3 times. The transmit LED illuminates in sets of triple flashes to indicate Level 3.

Car finder

Press and release 

The horn emits one long honk and the parking lights flash for 10 seconds. The parking light flashes stop if locked or unlocked while Car Finder is in progress. Lock and Unlock cancels the parking light flash.

Smart Start*

Press and release 

Activates (or if On, deactivates) Smart Start. The parking lights flash quickly five times for On and slowly five times for Off. The Remote Start LED and beeps play (1 for on, 2 for off) to confirm.

Note	System needs to be locked or Smart Start will not start the engine.
-------------	---

AUX 3

Press and release **AUX**

Activates (or if On, deactivates) the Aux 3 output. The Aux LED and On tones or Off tones play to confirm. See your authorized Directed dealer for details.

Runtime Remaining

Press and hold the button

Requests the remaining Remote start runtime and temporarily displays it in 4 increments using the green Ghost LED's.

Example for 12 minute runtime:

- 3 LED's: 6 to 9 minutes remaining (50 - 75% of time selected).
- 1 LED: less than 3 minutes remaining (<25% of time selected).

*See "Advanced Start" under "Remote Start Features" for more details.

Advanced Commands: (Level 4)

Press and release the **f** button 4 times. The transmit LED illuminates in sets of quadruple flashes to indicate Level 4.

Defogger*

Press and release 

Activates the vehicle Defogger circuit (if connected) while Remote Start is activated and the parking lights flash 3 times. The Remote start LED and 1 beep play to confirm. For convenience, the Defogger circuit will also automatically activate 10 seconds after remote starting if the temperature is below 55°F.

Note Remote Start must be active to use this feature.

AUX 4

Press and release **AUX**

Activates (or if On, deactivates) the Aux 4 output. The Aux LED and On tones or Off tones play to confirm.

* This feature must be installed and turned on by an authorized Directed dealer.

Remote Control Configuration

The remote controls have operations that can be configured to a user's personal preferences. The following instruction will direct you through the available configuration and programming options for the remote control.

Remote Programming

Enter programming, **press** and **hold** the **f** button for 8 seconds, the transmit LED turns on to indicate the Main Menu is accessed.

Exit programming or go back to a previous menu, **press** and release the **f** button. 1 short and 1 long beep is emitted for each step back. When programming is exited the transmit LED turns off.

Remote Pairing

Remote pairing is a process where the remote, and the in-vehicle system learn the other's encrypted identification, securing communication between the two from intruders.

The following instruction will step you through the remote pairing operation.



Prepare the vehicle system for pairing:

1. **Turn** the key to the ON position.
2. Within 5 seconds **press** and release 1 time the Control button on the Control Center.
3. Within 5 seconds, **press** and **hold** the Control button. The status LED will flash one time and the horn (if connected) honks once to confirm the system is ready for remote pairing.
4. **Release** the Control button and proceed to next step.

Pairing will exit if:

- Step 7 is not completed within 60 seconds
- The doors are closed
- The ignition is turned off.

Prepare the remote control for pairing:

5. Enter programming by pressing and holding the **f** button for 8 seconds to access the Main Menu.
6. **Press** and **hold** the  button for 1 second, 3 transmit LED flashes indicate the remote control is ready to pair.
7. **Press** the  button.

The horn (if connected) honks and the remote emits tones to confirm pairing is complete.



1-way companion: the horn honks to confirm the system has learned the remote control.

Remote Features

From the main menu, **press** the  button to access the remote operation features, 2 transmit LED flashes indicate the remote features menu is accessed. **Press** the buttons indicated in the tables below to set the feature option.



Responder LE

The Ghost LED's next to button indicate the feature setting.

Feature	Button Press	LED on	LED Off	LED flash	LED Double Flash
Keypad Lock		Auto	Off		
No function		No function	No function		
Car 2		Car 2 On	Car 2 Off		
Page Mode*	AUX			Power Save 1	Power Save 2

1-way companion remote control

The 1-way remote will flash the transmit LED to indicate the setting.

Feature	Button Press	Single Flash	Double Flash
Keypad Lock		Auto	Off *
No function		No function	No function
Car 2		Car 2 On	Car 2 Off *

Keypad Lock

Options: Off, Auto

When Off, the buttons do not lock and always perform a command when pressed. When set to Auto, the remote buttons lock after a 20 second lapse between button presses to prevent unintentional operations.

If a button is pressed when locked the **f** LED and a fault tone play as an alert. The 1-way companion emits the fault tone only.

To unlock the buttons, press the **f** button followed by the  button. The Ghost LEDs flash and tones play to confirm unlocking.

Auto unlocking

After turning the ignition off, a message to the Responder LE will unlock the keypad buttons until the next command is performed. If Auto Unlocking is not desired this message can be turned off by an authorized Directed Dealer.

Page Mode*

Options: Power Save 1, Power Save 2, On, Off.

The Responder LE remote monitors your system's messages via Paging. When Paging is On the remote wakes up every few seconds to detect pages from the system. When Off the remote does not wake up to receive pages from the system.

Power Save extends battery life by turning Paging Off after 72 hours if the remote control is not used during this period. Just press any button to resume system monitoring. See *Battery Life*.

* This option is not available with the 1-way companion remote.

Car 2

Options: Off, On

The remote controls can control two systems independently. When set to Off, the Car Select feature is not available. When set to On the Car Select feature is enabled.

See *Car Select (under Remote and System Operations)* for detail on using a remote with 2 systems.

Remote Beep

Options: On, Off

The Responder LE will emit a beep as confirmation of button presses and command responses. When set to Off, beeps are not emitted for any operations except programming.

For 1-way companion remote control, Off will delete all beeps except when programming.

Emergency Override

The override feature allows you to select a specific number of presses needed to disable the system.

If the override button has been programmed to a new number of presses by your authorized dealer, that number should be indicated as follows. Number of presses_____

1. Turn the ignition On.
2. Press the control button on the Control Center the correct number of times (the default is 1 press).
3. After a few seconds the horn output ceases and the system is disabled.

Note	As a precaution, if programmed for Passive Locking or Auto re-locking the system should be placed into Valet Mode until a remote is available.
-------------	--

Remote Start Features

Pit Stop Mode

To exit vehicle with engine running

The system keeps the engine running during short trips into the house or convenience store. To perform Pit Stop:

1. With the engine running, **set** the parking brake and **release** the foot brake.
2. **Press** the  button, the parking lights will turn on to indicate remote start is on.
3. **Turn** the key to off, and **remove** it from the ignition, the engine continues running for the programmed runtime.
4. **Exit** the vehicle and lock the system.

Note

For Pit Stop on manual transmission vehicles follow the directions in the *Manual Transmission Start (MTS mode)* section.

Key Takeover

When you are ready to drive

The system keeps the engine running until the vehicle is ready to be driven. To perform Key Takeover:

1. **Unlock** the system and **enter** the vehicle, do not step on the foot brake.
2. **Insert** the key, **turn** it to the run position, and then **step** on the foot brake, the remote start then turns off.
3. The parking lights turn off to indicate remote start is off.
4. The vehicle is ready to drive.

Remote Start Safe-lock

Remote start safe-lock makes sure the doors are locked while the engine is running and after, even if they are unlocked when remote start is activated. Door locks may require additional parts and labor.

Disabling Remote Start

Remote start can be disabled by moving the Toggle Switch to the Off position. If remote start is attempted while Off, the engine will not start. (See *Remote Start Fault* under *Remote Start Features*) move the switch back to the On position to resume normal operation.

Advanced Start

The Advanced start features; Timer Start and Smart Start will automatically start the engine to maintain battery charge or combat extreme cold when parked for an extended period of time.

Precautions for the Advanced Start features:

- Park the vehicle in a well ventilated area away from windows and doors that lead into inhabited spaces.
- Lock the vehicle, the engine will not start unless the doors are locked.
- Only one Advanced start feature can be enabled at any given time.
- For manual transmission vehicles MTS mode must be enabled before Timer Start or Smart Start can be activated.

Timer Start operation

Activation begins a countdown timer as set by the installer (default 3 hours). When the timer expires the engine starts. When the Remote start runtime expires the engine shuts off, and the countdown timer restarts. This will repeat as many times as set

by the installer (default 6 starts). Timer Start is exited after the final start.

Smart Start operation

Smart Start uses the settings for Timer Start in addition to temperature and battery level to automatically start the engine. Activation begins the countdown timer. When the timer expires the vehicle interior temperature and battery level is checked and, if the Temperature is above 100F, below 0F, or the battery level is below 10.5v, the engine will start. When the Remote start runtime expires the engine shuts off, and the countdown timer restarts. Smart Start is exited after the final start.

Note	The temperature and battery thresholds can be changed by an authorized Directed dealer if a higher or lower threshold is desired.
-------------	---

Temperature Reporting

During Remote start the vehicle interior is checked regularly for temperature changes. If a change in temperature is detected this report will be sent to the remote for display. Each time the remote receives this report it will beep and display the temperature as described for the Temperature Request in the Advanced Commands section Level 1.

Note	Temperature report must be turned on by an authorized Directed dealer.
-------------	--

Remote Start Time-out Alert

During remote start a message is sent three minutes before and again at one minute before the engine turns off. The **f** LED, Remote Start LED flash and several tones play as an alert to reset the runtime if desired.

Manual Transmission Start (MTS mode)

When installed into a manual transmission vehicle, the system requires that the MTS mode is properly set when parking. If MTS mode is not properly set or is defeated after being properly set the system will not start the engine.

1. With the engine running, **set** the parking brake and leave the engine running.
For Pit Stop or Turbo Timer mode (to leave the engine running after locking), **open** the driver door.
2. **Release** the foot brake (if pressed during Step 1), or **press** and **release** the foot brake anytime. As long as the engine is running there is no time limit to perform this step.
3. Within 20 seconds of foot brake release, **press** any command button on the remote, after 20 seconds return to Step 2 (For Turbo Timer Mode, press the optional dash mounted activation button or send the Timer Mode command).
4. The parking lights flash 5 times to confirm MTS mode is enabled and the remote start activates the ignition outputs.
5. **Turn** Off and **remove** the key from the ignition switch, the engine remains running.
6. **Exit** the vehicle, **close** all the doors and lock the system.
7. The engine turns off. If the door is opened in Step 1 then the engine continues to run.

Turbo Timer Mode

The system keeps the engine running for the Turbo Timer runtime and can be activated by remote control or optional dash mounted activation button.

1. With the engine running, **set** the parking brake.
2. **Press** the optional dash mounted activation button or perform the Timer Mode command.
3. The parking lights turn on and the remote start activates the ignition outputs.
4. **Turn** Off and **remove** the key from the ignition switch, the engine remains running.
5. **Exit** the vehicle, **close** all the doors and lock the system.
6. The engine runs for the Turbo Mode runtime.

Note	Turbo Timer must be turned on by an authorized Directed dealer.
-------------	---

Remote Start Faults

For user safety, the system must be properly configured or remote start will not activate. A Remote Start Fault may be caused by any of several configuration issues. Refer to the table below for the command type and parking light flashes that will identify the configuration issue and solution.

Flashes *	Possible Fault	Solution
5	Brake on	Release foot brake
6	Hood open	Close hood
7	After performing Remote Start command - MTS not enabled	Enable MTS mode
	After performing Timer Start or Smart Start command	Check all Solutions
8	Toggle Switch off	Turn switch on

* Refers to the number of parking light flashes.

Remote and System Operations

Passive Locking*

Park and exit the vehicle, after the doors are closed the Passive locking countdown begins. The led flashes quickly and upon reaching 20 seconds then the horn honks once. At 30 seconds the system locks itself.

Anytime before the system locks you can re-enter the vehicle or open the trunk to load or unload items and, after closing passive locking resumes.

To stay secure in case of accidental unlocking of the system, if a door is not opened within 30 seconds the system relocks the doors.

Auto Re-locking*

Auto re-locking ensures the vehicle stays protected if it is not entered after unlocking by remote control. After unlocking by remote, the doors automatically lock, if programmed on, in 30 seconds. Open any point of entry to stop the re-lock until the next unlock by remote.

Onetime Bypass*

Turn the ignition On for one to three seconds and then Off. The horn honks once to confirm one-time bypass is enabled.

One-time bypass can be used to temporarily bypass the Passive locking operation for one cycle. It also bypasses the comfort closure and auxiliary channel outputs if programmed to activate when locking. After the next unlock, all operations return to normal.

* The optional horn honk feature must be installed.

Valet Mode

Valet mode can be entered and exited by performing the Remote Valet command or manually using the vehicle key and the control button. When entered, the convenience features still operate normally.

Use the following steps to manually enter and exit Valet Mode:

1. **Turn** the ignition switch On and then Off
2. Immediately **press** and **release** the control button once
3. The control center LED turns On when entering and Off when exiting.

Power Save

To reduce power consumption the control center status LED modifies its output if the vehicle is parked for an extended period. If Locked the flashing is reduced after 24 hours. When Valet mode is On the LED turns off after 1 hour and resets each time the ignition is turned off.

Power Save extends battery life by turning Paging Off after 72 hours if the remote control is not used during this period. Just press any button to resume system monitoring. Power Save 2 is for maximum battery life and will monitor the system only when remote start has been activated. See *"Page Mode*" on page 17*.

Rapid Resume

If power is ever disconnected by a mechanic or thief, the system will resume the state it was in at the time of disconnection, when power is reconnected.

Automatic Remote Updates

The system sends a silent message to all remote controls after any major action has occurred. When the remote receives this message it updates the Lock status.

Car Select

Car 2 remote control option must first be turned On (See *Remote Control Configuration* section to turn on).

1. **Press** and **hold** the **f** button for 3 seconds. The LED flashes once or twice to indicate the selected Car is 1 or 2.
2. **Release** the button for Car Select or continue to **hold** for programming.
3. **Release** the **f** button, then **press** and **release** while the LED flashes continue to perform Car Select. Once the car is selected a command can be performed by pressing one of the command buttons.

System Expansion Options

Controlling two vehicles (Car Select)

The Responder LE and 1-way companion remotes can control systems in two vehicles saving the need for multiple remote controls. This feature also allows for customized system configurations on each vehicle that has more than one driver. See *Owner Recognition* following for details.

Owner recognition*

The system can be configured to recognize the remote used when unlocking and change selected features to match the remote users preferences. Memory seat adjustment, horn honks, passive locking, and remote button auto unlocking, can all be custom set for each remote user at the time of installation.

Comfort closure*

Comfort Closure emulates turning the key in the door cylinder or holding the lock button of an OEM keyless entry. It will automatically close the windows and sunroof on vehicles with this type of OEM convenience feature.

Driver door priority unlocking*

The door unlocking operation can be configured to emulate an OEM style of driver priority unlocking for added protection during locking.

Battery Information

The Responder LE remote is powered by 2 batteries (PB CR-2016) and the 1-way companion remote is powered by 1 battery (CR-2032) that can be purchased at most retailers. When the battery begins to weaken, the operating range will be reduced. The information and precautions in this section can help maximize your battery's life and usage in providing your Responder LE and 1-way companion remote controls with many years of trouble free operation.

Low Battery

After a command is performed the Responder LE and 1-way companion remote controls check their battery level. When the level requires attention, the remote will generate alerts. Once the alerts begin, the remote controls will remain operational for several days but the battery/batteries should be replaced at the earliest opportunity or failure to control the system may occur.

Low Battery Alerts

When unlocking the system using a remote with a low battery the 2-way remote emits 2 sets of beeps, the **f** LED flashes and additional horn honks are emitted. It is time to change the batteries. When the battery is low on the 1-way remote the only indication is additional horn honks* emitted when unlocking.

Battery Life

The Responder LE remote control has many features that make it one of the most unique remote controls on the market today. The default feature settings provide for excellent battery life. However, to maximize this battery life, the following suggestions will help:

- Turn Paging off: The remote will not wake up to check for messages with Paging off in the Setup Remote menu.
- Turn Beeps off: The Button beeps can be turned off in the Setup Remote menu. The command beeps still play normally.

Battery Replacement

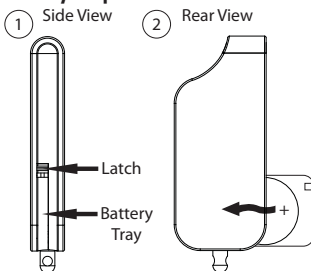

1. Using a small flat narrow object, push latch down towards battery tray while gently prying the tray outwards from both ends until released. Remove the tray from the remote control housing.

2. While observing the correct polarity, replace the old battery with

a new one. Seat battery flush into tray and slide back into housing until securely latched. The remote control is now ready for use.

* The optional horn honk feature must be installed. If confirmation honks are programmed off, the system will still emit one honk as an alert when unlocking.

Battery Disposal



Directed Electronics cares about the environment. If you need to dispose of the battery, please do so in accordance with your municipal requirements for battery disposal or return to Directed Electronics at: One Viper way, Vista, CA 92081 (Shipping and/or handling costs are the sole responsibility of the owner/sender and will not be covered by Directed Electronics).

Glossary of Terms

Document Terminology

Control Module	The “brain” of your system. Usually hidden underneath the dash area of the vehicle. It houses the microprocessor which monitors your vehicle and controls all of the system’s functions.
Remote Control	A hand-held, remote control which operates the various functions of your system.
Control Center	The control center contains the system’s radio-frequency antenna, the control button, and the Status LED. For maximum remote-control range, the control center is usually located at the top of the windshield, centered near the rear-view mirror.
Status LED	A light used to indicate the status of your system. It is located on your system’s Control Center.
Control Button	A small push button located on your system’s control center. It is used to override (unlock) the system when a remote is not available or to enter or exit Valet Mode.

Government Regulations

This device complies with Part 15 of FCC rules. Operation is subject to the following two conditions: (1) This device may not cause harmful interference, and (2) This device must accept any interference received, including interference that may cause undesirable operation.

This equipment has been tested and found to comply with the limits for a class B digital device, pursuant to Part 15 of the FCC Rules. These limits are designed to provide reasonable protection against harmful interference in a residential installation. This equipment generates and can radiate radio frequency energy and, if not installed and used in accordance with the instruction manual, may cause harmful interference to radio communications. However, there is no guarantee that interference will not occur in a particular installation. If this equipment does cause harmful interference to radio or television, which can be determined by turning the equipment OFF and ON, the user is encouraged to try to correct the interference by one or more of the following measures:

- Reorient or relocate the receiving antenna.
- Increase the separation between the equipment and receiver.
- Connect the equipment into an outlet on a circuit different from that to which the receiver is connected.
- Consult the dealer or an experienced radio / TV technician for help.

This device complies with the Industry Canada Radio Standards Specification RSS 210. Its use is authorized only on a no-interference, no-protection basis; in other words, this device must not be used if it is determined that it causes harmful interference to services authorized by IC. In addition, the user of this device must accept any radio interference that may be received, even if this interference could affect the operation of the device.

WARNING! Changes or modifications not expressly approved by the party responsible for compliance could void the user's authority to operate this device.

Warning! Safety First



Please read the safety warnings below before proceeding. Improper use of the product may be dangerous or illegal.

Installation

Due to the complexity of this system, installation of this product must only be performed by an authorized Directed dealer. If you have any questions, ask your retailer or contact Directed directly at 1-800-753-0600.

Remote Start Capable

When properly installed, this system can start the vehicle via a command signal from the remote control transmitter. Therefore, never operate the system in an enclosed area or partially enclosed area without ventilation (such as a garage). When parking in an enclosed or partially enclosed area or when having the vehicle serviced, the remote start system must be disabled using the installed menu wheel. It is the user's sole responsibility to properly handle and keep out of reach from children all remote control transmitters to assure that the system does not unintentionally remote start the vehicle. THE USER MUST INSTALL A CARBON MONOXIDE DETECTOR IN OR ABOUT THE LIVING AREA ADJACENT TO THE VEHICLE. ALL DOORS LEADING FROM ADJACENT LIVING AREAS TO THE ENCLOSED OR PARTIALLY ENCLOSED VEHICLE STORAGE AREA MUST AT ALL TIMES REMAIN CLOSED. These precautions are the sole responsibility of the user.

Manual Transmission Vehicles

Remote starters on manual transmission vehicles operate differently than those with automatic transmission because you must leave your car in neutral. You must read this Owner's Guide to familiarize yourself with the proper procedures regarding manual transmission remote starters. If you have any questions, ask your authorized Directed dealer or contact Directed at 1-800-753-0600.

Before remote starting a manual transmission vehicle, be sure to:

- Leave the vehicle in neutral and be sure no one is standing in front or behind the vehicle.
- Only remote start on a flat surface
- Have the parking brake fully engaged

WARNING! It is the responsibility of the owner to ensure the parking/emergency brake properly functions. Failure to do so can result in personal injury or property damage. We recommend the owner have the parking / emergency brake system inspected and adjusted by a qualified automotive shop biannually.

Use of this product in a manner contrary to its intended mode of operation may result in property damage, personal injury, or death. (1) Never remotely start the vehicle with the vehicle in gear, and (2) Never remotely start the vehicle with the keys in the ignition. The user must also have the neutral safety feature of the vehicle periodically checked, wherein the vehicle must not remotely start while the car is in gear. This testing should be performed by an authorized Directed dealer in accordance with the Safety Check outlined in the product installation guide. If the vehicle starts in gear, cease remote start operation immediately and consult with the authorized Directed dealer to fix the problem.

After the remote start module has been installed, contact your authorized dealer to have him or her test the remote start module by performing the Safety Check outlined in the product installation guide. If the vehicle starts when performing the Neutral Safety Shutdown Circuit test, the remote start unit has not been properly installed. The remote start module must be removed or the installer must properly reinstall the remote start system so that the vehicle does not start in gear. All installations must be performed by an authorized Directed dealer.

OPERATION OF THE REMOTE START MODULE IF THE VEHICLE STARTS IN

GEAR IS CONTRARY TO ITS INTENDED MODE OF OPERATION. OPERATING THE REMOTE START SYSTEM UNDER THESE CONDITIONS MAY RESULT IN PROPERTY DAMAGE OR PERSONAL INJURY. YOU MUST IMMEDIATELY CEASE THE USE OF THE UNIT AND SEEK THE ASSISTANCE OF AN AUTHORIZED Directed DEALER TO REPAIR OR DISCONNECT THE INSTALLED REMOTE START MODULE. DIRECTED WILL NOT BE HELD RESPONSIBLE OR PAY FOR INSTALLATION OR REINSTALLATION COSTS.

This product is designed for fuel injected vehicles only. Use of this product in a standard transmission vehicle must be in strict accordance with this guide.

This product should not be installed in any convertible vehicles, soft or hard top with a manual transmission. Installation in such vehicles may pose certain risk.

Interference

All radio devices are subject to interference which could affect proper performance.

Upgrades

Any upgrades to this product must be performed by an authorized Directed dealer. Do not attempt to perform any unauthorized modifications to this product.

Water/Heat Resistance

This product is not designed to be water and/or heat-resistant. Please take care to keep this product dry and away from heat sources. Any damage from water or heat will void the warranty.

Limited lifetime consumer warranty

Directed Electronics. ("Directed") promises to the original purchaser to repair or replace (at Directed's election) with a comparable reconditioned model any Directed unit (hereafter the "unit"), excluding without limitation the siren, the remote transmitters, the associated sensors and accessories, which proves to be defective in workmanship or material under reasonable use during the lifetime of the vehicle provided the following conditions are met: the unit was purchased from an authorized Directed dealer, the unit was professionally installed and serviced by an authorized Directed dealer; the unit will be professionally reinstalled in the vehicle in which it was originally installed by an authorized Directed dealer; and the unit is returned to Directed, shipping prepaid with a legible copy of the bill of sale or other dated proof of purchase bearing the following information: consumer's name, telephone number and address; the authorized dealers name, telephone number and address; complete product description, including accessories; the year, make and model of the vehicle; vehicle license number and vehicle identification number. All components other than the unit, including without limitation the siren, the remote transmitters and the associated sensors and accessories, carry a one-year warranty from the date of purchase of the same. ALL PRODUCTS RECEIVED BY DIRECTED FOR WARRANTY REPAIR WITHOUT PROOF OF PURCHASE FROM AN AUTHORIZED DEALER WILL BE DENIED. This warranty is non-transferable and is automatically void if: the unit's date code or serial number is defaced, missing or altered; the unit has been modified or used in a manner contrary to its intended purpose; the unit has been damaged by accident, unreasonable use, neglect, improper service, installation or other causes not arising out of defects in materials or construction. The warranty does not cover damage to the unit caused by installation or removal of the unit. Directed, in its sole discretion, will determine what constitutes excessive damage and may refuse the return of any unit with excessive damage. TO THE MAXIMUM EXTENT ALLOWED BY LAW, ALL WARRANTIES, INCLUDING BUT NOT LIMITED TO EXPRESS WARRANTY, IMPLIED WARRANTY, WARRANTY OF MERCHANTABILITY, FITNESS FOR PARTICULAR PURPOSE AND WARRANTY OF NON-INFRINGEMENT OF INTELLECTUAL PROPERTY, ARE EXPRESSLY EXCLUDED; AND DIRECTED NEITHER ASSUMES NOR AUTHORIZES ANY PERSON OR ENTITY TO ASSUME FOR IT ANY DUTY, OBLIGATION OR LIABILITY IN CONNECTION WITH ITS PRODUCTS. DIRECTED DISCLAIMS AND HAS ABSOLUTELY NO LIABILITY FOR ANY AND ALL ACTS OF THIRD PARTIES INCLUDING ITS AUTHORIZED DEALERS OR INSTALLERS. DIRECTED SECURITY SYSTEMS, INCLUDING THIS UNIT, ARE DETERRENTS AGAINST POSSIBLE THEFT. DIRECTED IS NOT OFFERING A GUARANTEE OR INSURANCE AGAINST VANDALISM, DAMAGE OR THEFT OF THE AUTOMOBILE, ITS PARTS OR CONTENTS; AND HEREBY EXPRESSLY DISCLAIMS ANY LIABILITY WHATSOEVER, INCLUDING WITHOUT LIMITATION, LIABILITY FOR THEFT, DAMAGE AND/OR VANDALISM. THIS WARRANTY DOES NOT COVER LABOR COSTS FOR MAINTENANCE, REMOVAL OR REINSTALLATION OF THE UNIT OR ANY CONSEQUENTIAL DAMAGES OF ANY KIND. IN THE EVENT OF A CLAIM

OR A DISPUTE INVOLVING DIRECTED OR ITS SUBSIDIARY, THE VENUE SHALL BE SAN DIEGO COUNTY IN THE STATE OF CALIFORNIA. CALIFORNIA STATE LAWS AND APPLICABLE FEDERAL LAWS SHALL APPLY AND GOVERN THE DISPUTE. THE MAXIMUM RECOVERY UNDER ANY CLAIM AGAINST DIRECTED SHALL BE STRICTLY LIMITED TO THE AUTHORIZED DIRECTED DEALER'S PURCHASE PRICE OF THE UNIT. DIRECTED SHALL NOT BE RESPONSIBLE FOR ANY DAMAGES WHATSOEVER, INCLUDING BUT NOT LIMITED TO, ANY CONSEQUENTIAL DAMAGES, INCIDENTAL DAMAGES, DAMAGE TO VEHICLE, DAMAGES FOR THE LOSS OF TIME, LOSS OF EARNINGS, COMMERCIAL LOSS, LOSS OF ECONOMIC OPPORTUNITY AND THE LIKE. NOTWITHSTANDING THE ABOVE, THE MANUFACTURER DOES OFFER A LIMITED WARRANTY TO REPLACE OR REPAIR THE CONTROL MODULE SUBJECT TO THE CONDITIONS AS DESCRIBED HEREIN. THIS WARRANTY IS VOID IF THE UNIT HAS NOT BEEN PURCHASED FROM DIRECTED, OR AN AUTHORIZED DIRECTED DEALER, OR IF THE UNIT HAS BEEN DAMAGED BY ACCIDENT, UNREASONABLE USE, NEGLIGENCE, ACTS OF GOD, NEGLIGENCE, IMPROPER SERVICE, OR OTHER CAUSES NOT ARISING OUT OF DEFECT IN MATERIALS OR CONSTRUCTION.

Some states do not allow limitations on how long an implied warranty will last or the exclusion or limitation of incidental or consequential damages. This warranty gives you specific legal rights and you may also have other rights that vary from State to State. This warranty is only valid for sale of product(s) within the United States of America and in Canada. Product(s) sold outside of the United States of America or Canada are sold "AS-IS" and shall have NO WARRANTY, express or implied.

For further details relating to warranty information of Directed products, please visit the support section of Directed's website at: www.directed.com.

This product may be covered by a Guaranteed Protection Plan ("GPP"). See your authorized Directed dealer for details of the plan or call Directed Customer Service at 1-800-876-0800.

920-10011-01-2011-06

Free Manuals Download Website

<http://myh66.com>

<http://usermanuals.us>

<http://www.somanuals.com>

<http://www.4manuals.cc>

<http://www.manual-lib.com>

<http://www.404manual.com>

<http://www.luxmanual.com>

<http://aubethermostatmanual.com>

Golf course search by state

<http://golfingnear.com>

Email search by domain

<http://emailbydomain.com>

Auto manuals search

<http://auto.somanuals.com>

TV manuals search

<http://tv.somanuals.com>