

1-WAY

CLIFFORD
THE SCIENCE OF SECURITY™



OWNER'S GUIDE

M O D E L
510.4X

Congratulations

Congratulations on the purchase of your state-of-the-art remote start and security system. Reading this Owner's Guide prior to using your system will help maximize the use of your system and its many features. Please visit the below website: <http://www.clifford.com> – For general and additional guide information. For any additional questions please contact your authorized Directed dealer or contact Directed at **1-800-753-0600**.

What you get

Welcome to the best generation of security with remote start. Your system contains everything you need.

- Two 1-way SuperCode remote controls
- Owner's guide
- Warranty card

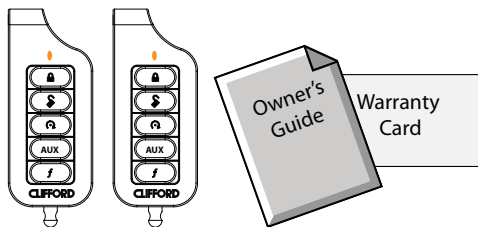

Important information

Government Regulations and Safety information



Read the *Government Regulations* and *Warning! Safety First* sections of this manual prior to operating this system.

Warning! Failure to heed this information can result in death, personal injury or property damage and may also result in the illegal use of the system beyond its intended purpose.

Your Warranty

Your system comes with a warranty. Please make sure you receive the warranty registration card and proof of purchase from your dealer indicating the product was installed by an authorized Directed dealer. Please validate it online at www.prodregister.com/directed or complete and return the warranty registration card.

Replacement remote controls

If additional remote controls (P/N 7153X) are desired, please see your authorized dealer or visit us at www.directedstore.com to order.

Contents

Getting Started.....	3
Keys to using this manual.....	3
Remote Control	4
Using your System.....	6
Commanding the system.....	6
Performing Commands	6
Remote Control Command table	7
Basic Commands (Direct Access)	8
Arm	8
Disarm	8
Remote Start.....	9
AUX/Trunk.....	9
Advanced Commands: (Level 1)	10
Silent Arm.....	10
Runtime Reset	10
AUX 1	10
Advanced Commands: (Level 2)	11
Sensor Bypass	11
Remote Valet	11
Timer Start*	12
AUX 2	12
Advanced Commands: (Level 3)	13
Sensor Silent Arm*	13
Smart Start**	13
AUX 3	13
Advanced Commands: (Level 4)	14
Full Silent Arm*	14
Defogger**	14
AUX 4	14
Remote Control Configuration	15
Remote Programming	15
Remote Pairing	15
Remote Features	16
Sensor Adjust	17
Alarm Features	18
Normal Arm Protection.....	18
Sensor Silent Arm protection	18
Sensor Warn-away output	19
Full Trigger output.....	19
Emergency Override	19
Trigger Zone Fault Report.....	19
Alarm Report.....	20

Nuisance Prevention (NPC)	20
Remote Start Features	21
Pit Stop Mode	21
Key Takeover.....	21
Remote Start Safe-lock	22
Disabling Remote Start	22
Advanced Start	22
Manual Transmission Start (MTS mode)	23
Turbo Timer Mode.....	24
Remote Start Faults.....	25
Remote and System Operations.....	26
Passive Arming*	26
Auto Re-arming*	26
Valet Mode	27
Power Save.....	27
Rapid Resume	27
Car Select.....	27
System Expansion Options	28
Battery Information.....	29
Low Battery Alerts	29
Battery Replacement.....	29
Battery Disposal	30
Patent Information	30
Glossary of Terms.....	31
Government Regulations	32
Warning! Safety First.....	33
Installation	33
Remote Start Capable	33
Manual Transmission Vehicles	33
Interference.....	35
Upgrades	35
Water/Heat Resistance	35
Limited lifetime consumer warranty	36

Getting Started

Keys to using this manual

Specific actions (in bold type) and style conventions are used consistently throughout this manual, they are as follows:

- **Press:** implies pushing in and releasing a button.
- **Hold:** is used after Press actions when a button needs to be held in position for an extended period of time, typically several seconds.
- *Italicized* words denote section/sub headings in this guide and can be located through the table of contents.
- An asterisk (*) when used after a word or phrase denotes that additional details can be found in related sections usually noted at the bottom of the page or end of the section.

Remote Control

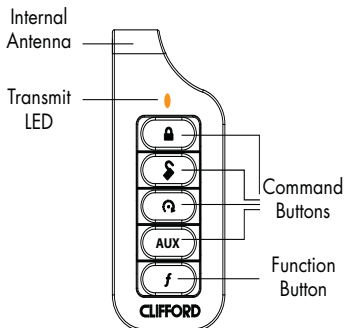

Feature	Description
Internal Antenna	Used for transmitting information
Transmit LED	Active when transmitting information
Command buttons (4)	Used to perform arming, disarming, auxiliary channel and remote start commands
Function button	Used to access function levels for commands, configuration menus for programming and Car Selection

Control Center

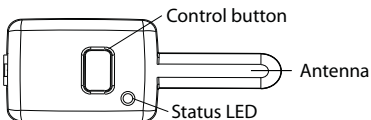

The Control Center, typically located on the upper part of the front windshield. It consists of:

- The In-vehicle system antenna.
- The Status LED, as a visual indicator of the system's status.
- The Control button, for placing the system into Valet Mode* and to perform the Emergency Override** operation.

* See *Remote and System Operations* section for details.

** See *Alarm Features* for details.

Using your System

Commanding the system

Commands, Basic or Advanced, are used to activate system features and are performed by pressing one of the Command buttons. Basic commands control the most often used security and remote start features while Advanced commands control more specialized features.

Confirmations for Basic or Advanced commands are indicated by siren chirps and parking light flashes. A description of each feature confirmation is found in the following Basic command and Advanced command sections.

Performing Commands



Perform Basic commands by pressing a Command button.

Perform Advanced Commands by first accessing Levels 1-4 using the **f** button and then by pressing a Command button while within a level.

Advanced command example: Silent Arm

1. **Press** the **f** button once to access Function Level 1, The transmit LED single flashes for 3 seconds.
2. **Press** the  button while the transmit LED is still flashing to perform the Silent Arm command.
3. The system will arm, lock the doors and flash the parking lights without siren chirps.

Remote Control Command table

Level Button	Direct Access	f x 1 LEVEL 1	f x 2 LEVEL 2	f x 3 LEVEL 3	f x 4 LEVEL 4
	Arm/Lock (Panic)	Silent Arm	Sensor Bypass	Sensor Silent Arm	Full Silent Arm
	Disarm/Unlock	Silent Disarm	Remote Valet	Car Finder	
	Remote Start	Runtime Reset	Timer Start	Smart Start	Defogger
AUX	Aux/Trunk	AUX 1	AUX 2	AUX 3	AUX 4
f	Advance Level, Enter program- ming (8 sec)				

Basic Commands (Direct Access)

Arm



Press and release 

The alarm arms, doors lock (if connected), and the siren chirps and parking lights flash once. If Valet mode* is On, the doors lock without siren chirps, the alarm is disabled. Exit Valet mode to arm the alarm normally.

If a trigger zone fault is detected the siren chirps once again and the control center LED generates a Trigger Zone Fault report**.

To Arm and Panic

Press and **hold** 

The alarm Arms (or Locks in Valet) and, after 2 seconds, sounds the siren and flashes the parking lights. **Press** the  or  button to stop the output.

Disarm

Press and release 

The alarm disarms, doors unlock (if connected), and the siren chirps and parking lights flash twice.

An Alarm Report** alert of 4 or 5 siren chirps will replace the normal disarm chirps if the alarm was triggered.

Remote Start

Press and release 

Activates (or if On, deactivates) the remote starter. The engine and parking lights turn On, or the engine and parking lights turn Off accordingly. If a Remote start configuration issue prevents the engine from starting, the parking lights flash a Remote Start fault report*** to identify the fault.

AUX/Trunk

Press and hold **AUX**

The Trunk opens (if connected) when this button is pressed for 2 seconds.

* See *Remote and System Operations* for details.

** See *Alarm Features* for details.

*** See *Remote Start Faults* (under *Remote Start Features*) for details.

For Manual transmission vehicles see *Manual Transmission Start* in the *Remote Start Features* section for more details.

Advanced Commands: (Level 1)

Press and release the **f** button 1 time. The transmit LED illuminates in sets of single flashes to indicate Level 1.

Silent Arm

Press and release 

The alarm arms, doors lock (if connected), and the parking lights flash once.

Silent Disarm

Press and release 

The alarm disarms, doors unlock (if connected), and the parking lights flash twice. The Silent Disarm output may be replaced by the Alarm Report*

Runtime Reset

Press and release 

If more time is needed while remote start is active, runtime reset will reset the runtime counter to the pre-programmed setting.

Note Remote Start must be On to use this feature.

AUX 1

Press and release **AUX**

Activates (or if On, deactivates) the Aux 1 output.

* See *Alarm Features* for details.

Advanced Commands: (Level 2)

Press and release the **f** button 2 times. The transmit LED illuminates in sets of double flashes to indicate Level 2.

Sensor Bypass

Press and release 

Performing the Sensor Bypass command will incrementally bypass sensor operations and be confirmed as follows:

- **Warn-away bypass:** The Parking lights flash 2 times. Sensors will be activated for Full Trigger levels of impact only.
- **Warn-away & Full trigger bypass:** The Parking lights flash 3 times. Sensors will not be activated for any level of impact.
- **Sensor Bypass off:** The Parking lights flash 1 time. Sensors are fully operational.

Note

System needs to be armed to perform Sensor Bypass.
Perform arm command any time to turn Sensor Bypass Off.

Remote Valet

Press and release 

Enters (or if On, exits) Valet Mode. The Control Center LED turns on and off accordingly.

Timer Start*

Press and release 

Activates (or if On, deactivates) Timer Start. The parking lights flash quickly four times for On and slowly four times for Off.

Note	System needs to be armed or Timer Start will not start the engine.
-------------	--

AUX 2

Press and release **AUX**

Activates (or if On, deactivates) the Aux 2 output.

* See *Advanced Start* under *Remote Start Features* for more details.

Advanced Commands: (Level 3)

Press and release the **f** button 3 times. The transmit LED illuminates in sets of triple flashes to indicate Level 3.

Sensor Silent Arm*

Press and release 

The alarm arms, doors lock, and the siren chirps and parking lights flash 3 times.

Car finder

Press and release 

The siren emits one long chirp and the parking lights flash for 10 seconds. The parking light flashes stop if armed or disarmed while Car Finder is in progress.

Smart Start**

Press and release 

Activates (or if On, deactivates) Smart Start. The parking lights flash quickly five times for On and slowly five times for Off.

Note	System needs to be armed or Smart Start will not start the engine.
-------------	--

AUX 3

Press and release **AUX**

Activates (or if On, deactivates) the Aux 3 output.

* See *Alarm Features* for more details.

** See *Advanced Start* under *Remote Start Features* for more details.

Advanced Commands: (Level 4)

Press and release the **f** button 4 times. The transmit LED illuminates in sets of quadruple flashes to indicate Level 4.

Full Silent Arm*

Press and release 

The alarm arms, doors lock, and the siren chirps and parking lights flash 4 times.

Defogger**

Press and release 

Activates the vehicle Defogger circuit (if connected) while Remote Start is activated and the parking lights flash 3 times. For convenience, the Defogger circuit will also automatically activate 10 seconds after remote starting if the temperature is below 55°F.

Note Remote Start must be active to use this feature.

AUX 4

Press and release **AUX**

Activates (or if On, deactivates) the Aux 4 output.

* See *Alarm Features* for more details.

** This feature must be installed and turned on by an authorized Directed dealer.

Remote Control Configuration

Remote Programming

The remote controls have operations that can be configured to a user's personal preferences. The following instruction will direct you through the available programming options for both remote controls.

Enter programming, **press** and **hold** the **f** button for 8 seconds, the transmit LED turns on to indicate the Main Menu is accessed.

Exit programming or go back to a previous menu, **press** and release the **f** button. When programming is exited the transmit LED turns off.

Remote Pairing

The following instruction will step you through the remote pairing operation.



Prepare the vehicle system for pairing:

1. **Open** at least one of the vehicle's doors.
2. **Turn** the key to the ON position.
3. Within 5 seconds **press** and release 1 time the Control button on the Control Center.
4. Within 5 seconds, **press** and **hold** the Control button. The status LED will flash one time and the siren will chirp once to confirm the system is ready for remote pairing.
5. **Release** the Control button and proceed to next step.

Pairing will exit if:

- Step 7 is not completed within 60 seconds
- The doors are closed
- The ignition is turned off.

Prepare the remote control for pairing:



6. Enter programming to access the Main Menu
7. **Press** and **hold** the  button for 1 second, 3 transmit LED flashes indicate the remote control is ready to pair.
8. **Press** the  button,

The siren will chirp to confirm the system has learned the remote control.

Remote Features

From the main menu, **press** the  button to access the remote operation features, 2 transmit LED flashes indicate the remote features menu is accessed. **Press** the buttons indicated in the tables below to set the feature option.

The remote control will flash the Transmit LED to indicate the setting.

Feature	Button Press	Single Flash	Double Flash
Keypad Lock		Auto	Off *
No function		No function	No function
Car 2		Car 2 On	Car 2 Off *

* Indicates default setting.

Keypad Lock

Options: Off, Auto

When Off, the buttons do not lock and always perform a command when pressed. When set to Auto, the remote buttons lock after a 20 second lapse between button presses to prevent unintentional operations.

To unlock the buttons, press the **f** button followed by the  button.

Note When the Keypad is locked, the remote control may appear to be non-operational. It will not transmit a command or illuminate the Transmit LED and needs to be unlocked to resume normal operation.

Car 2

Options: Off, On

The remote controls can control two systems independently. When set to Off, the Car Select feature is not available. When set to On the Car Select feature is enabled. See *Car Select* (under *Remote and System Operations*) for detail on using a remote with 2 systems.

Sensor Adjust

The  button is used for sensor adjustment, to avoid unintended alarm triggers; it is recommended that an authorized Directed dealer performs all sensor adjustments.

Alarm Features

Normal Arm Protection

Status LED: The Control Center Status LED flashes as a visual indicator that your vehicle's security system is active.

Starter Kill: The Failsafe starter kill relay prevents the engine from starting

Note May require additional parts and installation

Sensor triggers: The onboard shock sensor can distinguish minor impacts from major impacts to the vehicle exterior. Minor impacts causes the system to emit a Warn-away output. Major impacts caused for example by a forcible entry attempt, results in a Full Trigger output.

Point of entry triggers: Opening the hood or trunk causes a Full Trigger output, while opening a Door or turning on the Ignition causes the the siren to chirp 3 seconds before beginning the Full Trigger output. This 3 second delay allows time to disarm and silence the siren in case of accidental trigger.

Sensor Silent Arm protection

Sensor Warn-away and Sensor Full Trigger activations are defeated. Point of entry triggers will activate the Full Trigger output.

Full Silent Arm Protection

Sensor Warn-away, Sensor Full Trigger and Point of Entry activations are defeated. Only the Ignition input will activate the Full Trigger output.

Sensor Warn-away output

When the system sensors detect a Warn-away trigger the siren chirps and parking lights flash for 3 seconds.

Full Trigger output

An alarm Full Trigger will sound the siren and flash the parking lights for 30 seconds.

Emergency Override

The following procedure disarms the system when a programmed remote is not available. Number of presses _____

1. **Turn** the ignition On.
2. **Press** the control button on the Control Center the correct number of times (the default is 1 press).
3. After a few seconds the siren output ceases and the system is disarmed.

Note

As a precaution, if programmed for Passive Arming or Auto re-arming the system should be placed into Valet Mode until a remote is available .

Trigger Zone Fault Report

When armed by remote command the system runs a status check of the alarm trigger zones. Faulty zones (usually caused by dome light delay or open trunk) are bypassed and reported via the control center LED, while all other trigger zones remain active and are monitored to protect the vehicle. Should a faulty zone self correct (dome light turns off) it becomes active and is then monitored normally.

The siren chirps once again a few seconds following the arming chirps as an audible alert, the control center LED flashes in groups to indicate the zone number.

Alarm Report

If the alarm was triggered while armed, it will be reported when the alarm is disarmed via siren chirps, parking light and control center LED flashes. The siren chirps 4 times (or 5 times if NPC On*), the parking lights flash 3 times, and the control center LED flashes in groups to indicate the last two zones that were triggered (see Table of Zones). The report output will repeat for each disarm operation until the ignition is turned on.

* See *Nuisance Prevention (NPC)* for more details.

Table of Zones

Zone # (led flashes)	Zone Name
1	Trunk
2	Shock Sensor
3	Door
4	Sensor 2
5	Ignition
6	Hood

Nuisance Prevention (NPC)

NPC monitors all alarm zones and, if any are triggered excessively, bypasses them until corrected. If a point of entry (trunk, hood, door) is left open following a forced entry, it is bypassed. It becomes active again only after being closed.

Bypassed sensors automatically reset after one hour and after the vehicle is driven. Disarming then re-arming the alarm does not reset bypassed sensors.

Remote Start Features

Pit Stop Mode

To exit vehicle with engine running

The system keeps the engine running during short trips into the house or convenience store. To perform Pit Stop:

1. With the engine running, **set** the parking brake and **release** the foot brake.
2. **Press** the  button, the parking lights will turn on to indicate remote start is on.
3. **Turn** the key to off, and **remove** it from the ignition, the engine continues running for the programmed runtime.
4. **Exit** the vehicle and **arm** the alarm.

Note For Pit Stop on manual transmission vehicles follow the directions in the *Manual Transmission Start (MTS mode)* section.

Key Takeover

When you are ready to drive

The system keeps the engine running until the vehicle is ready to be driven. To perform Key Takeover:

1. **Disarm** the system and **enter** the vehicle, do not step on the foot brake.
2. **Insert** the key, **turn** it to the run position, and then **step** on the foot brake, the remote start then turns off.
3. The parking lights turn off to indicate remote start is off.
4. The vehicle is ready to drive.

Remote Start Safe-lock

Remote start safe-lock makes sure the doors are locked while the engine is running and after, even if they are unlocked when remote start is activated. Door locks may require additional parts and labor.

Disabling Remote Start

Remote start can be disabled by moving the Toggle Switch to the Off position. If remote start is attempted while Off, the engine will not start. (See *Remote Start Fault* under *Remote Start Features*) move the switch back to the On position to resume normal operation.

Advanced Start

The Advanced start features; Timer Start and Smart Start will automatically start the engine to maintain battery charge or combat extreme cold when parked for an extended period of time.

Precautions for the Advanced Start features:

- Park the vehicle in a well ventilated area away from windows and doors that lead into inhabited spaces.
- Arm and Lock the vehicle, the engine will not start unless the doors are locked.
- Only one Advanced start feature can be enabled at any given time.
- For manual transmission vehicles MTS mode must be enabled before Timer Start or Smart Start can be activated.

Timer Start operation

Activation begins a countdown timer as set by the installer (default 3 hours). When the timer expires the engine starts. When the Remote start runtime expires the engine shuts off, and the countdown timer restarts. This will repeat as many times as set

by the installer (default 6 starts). Timer Start is exited after the final start.

Smart Start operation

Smart Start uses the settings for Timer Start in addition to temperature and battery level to automatically start the engine. Activation begins the countdown timer. When the timer expires the vehicle interior temperature and battery level is checked and, if the Temperature is above 100F, below 0F, or the battery level is below 10.5v, the engine will start. When the Remote start runtime expires the engine shuts off, and the countdown timer restarts. Smart Start is exited after the final start.

Note	The temperature and battery thresholds can be changed by an authorized Directed dealer if a higher or lower threshold is desired.
-------------	---

Manual Transmission Start (MTS mode)

When installed into a manual transmission vehicle, the system requires that the MTS mode is properly set when parking. If MTS mode is not properly set or is defeated after being properly set the system will not start the engine.

1. With the engine running, **set** the parking brake and leave the engine running.
For Pit Stop or Turbo Timer mode (to leave the engine running after arming), **open** the driver door.
2. **Release** the foot brake (if pressed during Step 1), or **press** and **release** the foot brake anytime. As long as the engine is running there is no time limit to perform this step.
3. Within 20 seconds of foot brake release, **press** any command

button on the remote, after 20 seconds return to Step 2 (For Turbo Timer Mode, press the optional dash mounted activation button or send the Timer Mode command.

4. The parking lights flash 5 times to confirm MTS mode is enabled and the remote start activates the ignition outputs.
5. **Turn Off** and **remove** the key from the ignition switch, the engine remains running.
6. **Exit** the vehicle, **close** all the doors and **arm** the system.
7. The engine turns off. If the door is opened in Step 1 then the engine continues to run.

Turbo Timer Mode

The system keeps the engine running for the Turbo Timer runtime and can be activated by remote control or optional dash mounted activation button.

1. With the engine running, **set** the parking brake.
2. **Press** the optional dash mounted activation button or perform the Timer Mode command.
3. The parking lights turn on and the remote start activates the ignition outputs.
4. **Turn Off** and **remove** the key from the ignition switch, the engine remains running.
5. **Exit** the vehicle, **close** all the doors and **arm** the system.
6. The engine runs for the Turbo Mode runtime.

Note

Turbo Timer must be turned on by an authorized Directed dealer.

Remote Start Faults

For user safety, the system must be properly configured or remote start will not activate. A Remote Start Fault may be caused by any of several configuration issues. Refer to the table below for the command type and parking light flashes that will identify the configuration issue and solution.

Flashes *	Possible Fault	Solution
5	Brake on	Release foot brake
6	Hood open	Close hood
7	After performing Remote Start command - MTS not enabled	Enable MTS mode
	After performing Timer Start or Smart Start command	Check all Solutions
8	Toggle Switch off	Turn switch on
None	Alarm is triggered	Disarm or reset alarm

* Refers to the number of parking light flashes.

Remote and System Operations

Passive Arming*

Park and exit the vehicle, after the doors are closed the Passive arming countdown begins. The led flashes quickly and upon reaching 20 seconds the siren then chirps once. At 30 seconds the system arms itself.

Anytime before the system arms you can re-enter the vehicle or open the trunk to load or unload items and, after closing passive arming resumes.

To stay secure in case of accidental disarming the system, if a door is not opened within 30 seconds the system re-arms itself and locks the doors.

Auto Re-arming*

Auto re-arm ensures the vehicle stays protected if it is not entered after disarming by remote control. After disarming by remote, the alarm automatically re-arms itself (and locks the doors if programmed on) in 30 seconds. Open any point of entry to stop the re-arm until the next disarm by remote.

Onetime Bypass*

Turn the ignition On for one to three seconds and then Off. The siren chirps once to confirm one-time bypass is enabled.

One-time bypass can be used to temporarily bypass the Passive arming operation for one cycle. It also bypasses the comfort closure and auxiliary channel outputs if programmed to activate when arming. After the next disarm all operations return to normal.

* These features must be turned on by an authorized Directed dealer.

Valet Mode

Valet mode can be entered and exited by performing the Remote Valet command or manually using the vehicle key and the control button. When entered, the alarm functions are defeated while the convenience features still operate normally.

Use the following steps to manually enter and exit Valet Mode:

1. **Turn** the ignition switch On and then Off
2. Immediately **press** and **release** the control button once
3. The control center LED turns On when entering and Off when exiting.

Power Save

To reduce power consumption the control center status LED modifies its output if the vehicle is parked for an extended period. If Armed the flashing is reduced after 24 hours. When Valet mode is On the LED turns off after 1 hour and resets each time the ignition is turned off.

Rapid Resume

If power is ever disconnected by a mechanic or thief, the system will resume the state it was in at the time of disconnection, when power is reconnected.

Car Select

Car 2 remote control option must first be turned On (See *Remote Control Configuration* section to turn on). **Press** and **hold** the **f** button for 3 seconds. The LED flashes once or twice to indicate the selected Car is 1 or 2, **release** the button for Car Select or continue to **hold** for programming.

Release the **f** button, then **press** and **release** while the LED flashes continue to perform Car Select. Once the car is selected a command can be performed by pressing one of the command buttons.

System Expansion Options

Controlling two vehicles (Car Select)

The remote controls can control systems in two different vehicles saving the need for multiple remote controls. This feature also allows for customized system configurations on each vehicle that has more than one driver. See *Owner Recognition* for details.

Owner recognition *

The system can be configured to recognize the remote used when disarming and change selected features to match the remote users preferences. Memory seat adjustment, siren chirps, passive arming, remote button auto unlocking, alarm output duration can all be custom set for each remote user at the time of installation.

Comfort closure *

Comfort Closure emulates turning the key in the door cylinder or holding the lock button of an OEM keyless entry. It will automatically close the windows and sunroof on vehicles with this type of OEM convenience feature.

Alarm output duration *

The length of time the siren sounds can be adjusted from 1 to 180 seconds at the time of installation.

Arming and Warn-away chirp control *

The system Arm, Disarm and Sensor Warn-away chirps can be configured for those that prefer a custom silent alarm operation.

Driver door priority unlocking *

The door unlocking operation can be configured to emulate an OEM style of driver priority unlocking for added security during disarming.

* These features must be turned on by an authorized Directed dealer.

Battery Information

The remote controls are powered by 1 coin cell battery (CR-2032) that can be purchased at most retailers. When the battery begins to weaken, the operating range will be reduced. The information and precautions in this section can help maximize your battery's life and usage in providing you with many years of trouble free operation.

Low Battery Alerts

When disarming the system using a remote with a low battery the siren will emit one additional chirp as an alert. If confirmation chirps are programmed off, the system will still emit one chirp as an alert when disarming.

Battery Replacement

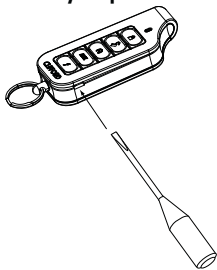

1. Using a small flat-head screwdriver, insert into slot located at the bottom of the keypad and carefully pry the front of the unit open.

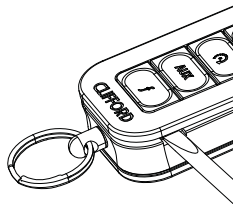

2. Turn both the unit front and circuit board over, remove battery from clip and replace.

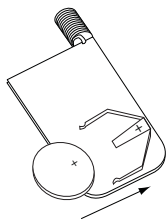

Note Verify that the battery polarity is correct when replacing.

3. With the front and circuit board still turned over, turn back portion of unit onto both parts, reposition all parts and snap together.

Battery Disposal



Directed Electronics cares about the environment. If you need to dispose of the battery, please do so in accordance with your municipal requirements for battery disposal or return to Directed Electronics at: One Viper way, Vista, CA 92081 (Shipping and/or handling costs are the sole responsibility of the owner/sender and will not be covered by Directed Electronics).

Patent Information

This product is covered by one or more of the following United States patents:

Remote Start Patents:

5,349,931; 5,872,519; 5,914,667; 5,952,933; 5,945,936;
5,990,786; 6,028,372; 6,467,448; 6,561,151; 7,191,053;
7,483,783

Vehicle Security Patents:

5,467,070; 5,532,670; 5,534,845; 5,563,576; 5,646,591;
5,650,774; 5,673,017; 5,712,638; 5,872,519; 5,914,667;
5,952,933; 5,945,936; 5,990,786; 6,028,505; 6,452,484

Other patents pending.

Glossary of Terms

Document Terminology

Control Module	The “brain” of your system. Usually hidden underneath the dash area of the vehicle. It houses the microprocessor which monitors your vehicle and controls all of the system’s functions.
Remote Control	A hand-held, remote control which operates the various functions of your system.
Control Center	The control center contains the system’s radio-frequency antenna, the control button, and the Status LED. For maximum remote-control range, the control center is usually located at the top of the windshield, centered near the rear-view mirror.
Status LED	A light used to indicate the status of your system. It is located on your system’s Control Center.
Control Button	A small push button located on your system’s control center. It is used to override (disarm) the alarm when a remote is not available or to enter or exit Valet Mode.

Government Regulations

This device complies with Part 15 of FCC rules. Operation is subject to the following two conditions: (1) This device may not cause harmful interference, and (2) This device must accept any interference received, including interference that may cause undesirable operation.

This equipment has been tested and found to comply with the limits for a class B digital device, pursuant to Part 15 of the FCC Rules. These limits are designed to provide reasonable protection against harmful interference in a residential installation. This equipment generates and can radiate radio frequency energy and, if not installed and used in accordance with the instruction manual, may cause harmful interference to radio communications. However, there is no guarantee that interference will not occur in a particular installation. If this equipment does cause harmful interference to radio or television, which can be determined by turning the equipment OFF and ON, the user is encouraged to try to correct the interference by one or more of the following measures:

- Reorient or relocate the receiving antenna.
- Increase the separation between the equipment and receiver.
- Connect the equipment into an outlet on a circuit different from that to which the receiver is connected.
- Consult the dealer or an experienced radio / TV technician for help.

This device complies with the Industry Canada Radio Standards Specification RSS 210. Its use is authorized only on a no-interference, no-protection basis; in other words, this device must not be used if it is determined that it causes harmful interference to services authorized by IC. In addition, the user of this device must accept any radio interference that may be received, even if this interference could affect the operation of the device.

WARNING! Changes or modifications not expressly approved by the party responsible for compliance could void the user's authority to operate this device.

Warning! Safety First



Please read the safety warnings below before proceeding. Improper use of the product may be dangerous or illegal.

Installation

Due to the complexity of this system, installation of this product must only be performed by an authorized Directed dealer. If you have any questions, ask your retailer or contact Directed directly at 1-800-753-0600.

Remote Start Capable

When properly installed, this system can start the vehicle via a command signal from the remote control transmitter. Therefore, never operate the system in an enclosed area or partially enclosed area without ventilation (such as a garage). When parking in an enclosed or partially enclosed area or when having the vehicle serviced, the remote start system must be disabled using the installed menu wheel. It is the user's sole responsibility to properly handle and keep out of reach from children all remote control transmitters to assure that the system does not unintentionally remote start the vehicle. THE USER MUST INSTALL A CARBON MONOXIDE DETECTOR IN OR ABOUT THE LIVING AREA ADJACENT TO THE VEHICLE. ALL DOORS LEADING FROM ADJACENT LIVING AREAS TO THE ENCLOSED OR PARTIALLY ENCLOSED VEHICLE STORAGE AREA MUST AT ALL TIMES REMAIN CLOSED. These precautions are the sole responsibility of the user.

Manual Transmission Vehicles

Remote starters on manual transmission vehicles operate differently than those with automatic transmission because you must leave your car in neutral. You must read this Owner's Guide to familiarize yourself with the proper procedures regarding manual transmission remote starters. If you have any questions, ask your authorized Directed dealer or contact Directed at 1-800-753-0600.

Before remote starting a manual transmission vehicle, be sure to:

- Leave the vehicle in neutral and be sure no one is standing in front or behind the vehicle.
- Only remote start on a flat surface
- Have the parking brake fully engaged

WARNING! It is the responsibility of the owner to ensure the parking/emergency brake properly functions. Failure to do so can result in personal injury or property damage. We recommend the owner have the parking / emergency brake system inspected and adjusted by a qualified automotive shop biannually.

Use of this product in a manner contrary to its intended mode of operation may result in property damage, personal injury, or death. (1) Never remotely start the vehicle with the vehicle in gear, and (2) Never remotely start the vehicle with the keys in the ignition. The user must also have the neutral safety feature of the vehicle periodically checked, wherein the vehicle must not remotely start while the car is in gear. This testing should be performed by an authorized Directed dealer in accordance with the Safety Check outlined in the product installation guide. If the vehicle starts in gear, cease remote start operation immediately and consult with the authorized Directed dealer to fix the problem.

After the remote start module has been installed, contact your authorized dealer to have him or her test the remote start module by performing the Safety Check outlined in the product installation guide. If the vehicle starts when performing the Neutral Safety Shutdown Circuit test, the remote start unit has not been properly installed. The remote start module must be removed or the installer must properly reinstall the remote start system so that the vehicle does not start in gear. All installations must be performed by an authorized Directed dealer.

OPERATION OF THE REMOTE START MODULE IF THE VEHICLE STARTS IN

GEAR IS CONTRARY TO ITS INTENDED MODE OF OPERATION. OPERATING THE REMOTE START SYSTEM UNDER THESE CONDITIONS MAY RESULT IN PROPERTY DAMAGE OR PERSONAL INJURY. YOU MUST IMMEDIATELY CEASE THE USE OF THE UNIT AND SEEK THE ASSISTANCE OF AN AUTHORIZED Directed DEALER TO REPAIR OR DISCONNECT THE INSTALLED REMOTE START MODULE. DIRECTED WILL NOT BE HELD RESPONSIBLE OR PAY FOR INSTALLATION OR REINSTALLATION COSTS.

This product is designed for fuel injected vehicles only. Use of this product in a standard transmission vehicle must be in strict accordance with this guide.

This product should not be installed in any convertible vehicles, soft or hard top with a manual transmission. Installation in such vehicles may pose certain risk.

Interference

All radio devices are subject to interference which could affect proper performance.

Upgrades

Any upgrades to this product must be performed by an authorized Directed dealer. Do not attempt to perform any unauthorized modifications to this product.

Water/Heat Resistance

This product is not designed to be water and/or heat-resistant. Please take care to keep this product dry and away from heat sources. Any damage from water or heat will void the warranty.

Limited lifetime consumer warranty

Directed Electronics. ("Directed") promises to the original purchaser to repair or replace (at Directed's election) with a comparable reconditioned model any Directed unit (hereafter the "unit"), excluding without limitation the siren, the remote transmitters, the associated sensors and accessories, which proves to be defective in workmanship or material under reasonable use during the lifetime of the vehicle provided the following conditions are met: the unit was purchased from an authorized Directed dealer, the unit was professionally installed and serviced by an authorized Directed dealer; the unit will be professionally reinstalled in the vehicle in which it was originally installed by an authorized Directed dealer; and the unit is returned to Directed, shipping prepaid with a legible copy of the bill of sale or other dated proof of purchase bearing the following information: consumer's name, telephone number and address; the authorized dealers name, telephone number and address; complete product description, including accessories; the year, make and model of the vehicle; vehicle license number and vehicle identification number. All components other than the unit, including without limitation the siren, the remote transmitters and the associated sensors and accessories, carry a one-year warranty from the date of purchase of the same. ALL PRODUCTS RECEIVED BY DIRECTED FOR WARRANTY REPAIR WITHOUT PROOF OF PURCHASE FROM AN AUTHORIZED DEALER WILL BE DENIED. This warranty is non-transferable and is automatically void if: the unit's date code or serial number is defaced, missing or altered; the unit has been modified or used in a manner contrary to its intended purpose; the unit has been damaged by accident, unreasonable use, neglect, improper service, installation or other causes not arising out of defects in materials or construction. The warranty does not cover damage to the unit caused by installation or removal of the unit. Directed, in its sole discretion, will determine what constitutes excessive damage and may refuse the return of any unit with excessive damage. TO THE MAXIMUM EXTENT ALLOWED BY LAW, ALL WARRANTIES, INCLUDING BUT NOT LIMITED TO EXPRESS WARRANTY, IMPLIED WARRANTY, WARRANTY OF MERCHANTABILITY, FITNESS FOR PARTICULAR PURPOSE AND WARRANTY OF NON-INFRINGEMENT OF INTELLECTUAL PROPERTY, ARE EXPRESSLY EXCLUDED; AND DIRECTED NEITHER ASSUMES NOR AUTHORIZES ANY PERSON OR ENTITY TO ASSUME FOR IT ANY DUTY, OBLIGATION OR LIABILITY IN CONNECTION WITH ITS PRODUCTS. DIRECTED DISCLAIMS AND HAS ABSOLUTELY NO LIABILITY FOR ANY AND ALL ACTS OF THIRD PARTIES INCLUDING ITS AUTHORIZED DEALERS OR INSTALLERS. DIRECTED SECURITY SYSTEMS, INCLUDING THIS UNIT, ARE DETERRENTS AGAINST POSSIBLE THEFT. DIRECTED IS NOT OFFERING A GUARANTEE OR INSURANCE AGAINST VANDALISM, DAMAGE OR THEFT OF THE AUTOMOBILE, ITS PARTS OR CONTENTS; AND HEREBY EXPRESSLY DISCLAIMS ANY LIABILITY WHATSOEVER, INCLUDING WITHOUT LIMITATION, LIABILITY FOR THEFT, DAMAGE AND/OR VANDALISM. THIS WARRANTY DOES NOT COVER LABOR COSTS FOR MAINTENANCE, REMOVAL OR REINSTALLATION OF THE UNIT OR

ANY CONSEQUENTIAL DAMAGES OF ANY KIND. IN THE EVENT OF A CLAIM OR A DISPUTE INVOLVING DIRECTED OR ITS SUBSIDIARY, THE VENUE SHALL BE SAN DIEGO COUNTY IN THE STATE OF CALIFORNIA. CALIFORNIA STATE LAWS AND APPLICABLE FEDERAL LAWS SHALL APPLY AND GOVERN THE DISPUTE. THE MAXIMUM RECOVERY UNDER ANY CLAIM AGAINST DIRECTED SHALL BE STRICTLY LIMITED TO THE AUTHORIZED DIRECTED DEALER'S PURCHASE PRICE OF THE UNIT. DIRECTED SHALL NOT BE RESPONSIBLE FOR ANY DAMAGES WHATSOEVER, INCLUDING BUT NOT LIMITED TO, ANY CONSEQUENTIAL DAMAGES, INCIDENTAL DAMAGES, DAMAGE TO VEHICLE, DAMAGES FOR THE LOSS OF TIME, LOSS OF EARNINGS, COMMERCIAL LOSS, LOSS OF ECONOMIC OPPORTUNITY AND THE LIKE. NOTWITHSTANDING THE ABOVE, THE MANUFACTURER DOES OFFER A LIMITED WARRANTY TO REPLACE OR REPAIR THE CONTROL MODULE SUBJECT TO THE CONDITIONS AS DESCRIBED HEREIN. THIS WARRANTY IS VOID IF THE UNIT HAS NOT BEEN PURCHASED FROM DIRECTED, OR AN AUTHORIZED DIRECTED DEALER, OR IF THE UNIT HAS BEEN DAMAGED BY ACCIDENT, UNREASONABLE USE, NEGLIGENCE, ACTS OF GOD, NEGLIGENCE, IMPROPER SERVICE, OR OTHER CAUSES NOT ARISING OUT OF DEFECT IN MATERIALS OR CONSTRUCTION.

Some states do not allow limitations on how long an implied warranty will last or the exclusion or limitation of incidental or consequential damages. This warranty gives you specific legal rights and you may also have other rights that vary from State to State.

This warranty is only valid for sale of product(s) within the United States of America and in Canada. Product(s) sold outside of the United States of America or Canada are sold "AS-IS" and shall have NO WARRANTY, express or implied.

For further details relating to warranty information of Directed products, please visit the support section of Directed's website at: www.directed.com

This product may be covered by a Guaranteed Protection Plan ("GPP"). See your authorized Directed dealer for details of the plan or call Directed Customer Service at 1-800-876-0800.

Free Manuals Download Website

<http://myh66.com>

<http://usermanuals.us>

<http://www.somanuals.com>

<http://www.4manuals.cc>

<http://www.manual-lib.com>

<http://www.404manual.com>

<http://www.luxmanual.com>

<http://aubethermostatmanual.com>

Golf course search by state

<http://golfingnear.com>

Email search by domain

<http://emailbydomain.com>

Auto manuals search

<http://auto.somanuals.com>

TV manuals search

<http://tv.somanuals.com>