

CLIFFORD®

Remote Start Keyless Entry
Model 1.2
Owner's Guide

Directed®
E L E C T R O N I C S

© 2008 Directed Electronics, Vista, CA
G4102X 2008-09

Contents

Government regulations	5
Warning! Safety first	7
What's included.....	9
Important information	9
Your warranty.....	9
Replacement remote controls	9
System maintenance.....	10
Low battery indicator	10
Battery replacement	10
Two car operation.....	11
1-way remote	12
Transmitter configuration.....	13
Feature list	14
Using the system	17
Locking the vehicle.....	17
Unlocking the vehicle	17
Valet mode	18
Panic Mode	18
Remote feature programming	19
Overriding the optional starter kill.....	20
Using the remote start.....	21
Manual transmission vehicles	22
Timer mode.....	23
Turbo timer mode.....	24
Smart start activation.....	25
Turning on the rear defogger.....	27
Valet take-over	27
Safety features	28
Optional starter anti-grind circuitry.....	28
Disabling the remote start system	28
Diagnostics	29
Locking.....	29
Unlocking	29
Remote start	29
Owner recognition	30
Rapid resume logic.....	30
Power saver mode.....	30
Programming options.....	31
Convenience expansions.....	32
Glossary of terms	33
Quick reference guide	35
Limited lifetime consumer warranty	37

Government regulations

This device complies with Part 15 of FCC rules. Operation is subject to the following two conditions: (1) This device may not cause harmful interference, and (2) This device must accept any interference received, including interference that may cause undesirable operation.

This equipment has been tested and found to comply with the limits for a class B digital device, pursuant to Part 15 of the FCC Rules. These limits are designed to provide reasonable protection against harmful interference in a residential installation. This equipment generates and can radiate radio frequency energy and, if not installed and used in accordance with the instruction manual, may cause harmful interference to radio communications. However, there is no guarantee that interference will not occur in a particular installation. If this equipment does cause harmful interference to radio or television, which can be determined by turning the equipment Off and ON, the user is encouraged to try to correct the interference by one or more of the following measures:

- Reorient or relocate the receiving antenna.
- Increase the separation between the equipment and receiver.
- Connect the equipment into an outlet on a circuit different from that to which the receiver is connected.
- Consult the dealer or an experienced radio / TV technician for help.

To satisfy FCC RF exposure compliance requirements, this device should be used in hand-held, hand operated configurations only. The device and its antenna must maintain a separation distance of 20 cm or more from the person's body, except for the hand and wrists, to satisfy RF exposure compliance. This device is designed to be used in a person's hands and its operating configurations do not support normal transmissions while it is carried in pockets or holsters next to a persons' body.

This device complies with the Industry Canada Radio Standards Specification RSS 210. Its use is authorized only on a no-interference, no-protection basis; in other words, this device must not be used if it is determined that it causes harmful interference to services authorized by IC. In addition, the user of this device must accept any radio interference that may be received, even if this interference could affect the operation of the device.

Warning:

Changes or modifications not expressly approved by the party responsible for compliance could void the user's authority to operate this device.

Warning! Safety first

The following safety warnings must be observed at all times:

Due to the complexity of this system, installation of this product must only be performed by an authorized Directed dealer.

When properly installed, this system can start the vehicle via a command signal from the remote control transmitter. Therefore, never operate the system in an enclosed area or partially enclosed area without ventilation (such as a garage). When parking in an enclosed or partially enclosed area or when having the vehicle serviced, the remote start system must be disabled using the installed toggle switch. It is the user's sole responsibility to properly handle and keep out of reach from children all remote control transmitters to assure that the system does not unintentionally remote start the vehicle. THE USER MUST INSTALL A CARBON MONOXIDE DETECTOR IN OR ABOUT THE LIVING AREA ADJACENT TO THE VEHICLE. ALL DOORS LEADING FROM ADJACENT LIVING AREAS TO THE ENCLOSED OR PARTIALLY ENCLOSED VEHICLE STORAGE AREA MUST AT ALL TIMES REMAIN CLOSED. These precautions are the sole responsibility of the user.

Remote starters on manual transmission vehicles operate differently than those with automatic transmission because you must leave your car in neutral. You must read this Owner's Guide to familiarize yourself with the proper procedures regarding manual transmission remote starters. If you have any questions, ask your installer or contact Directed at 1-800-753-0600.

Before remote starting a manual transmission vehicle, be sure to:

- Leave the vehicle in neutral and be sure no one is standing in front or behind the vehicle.
- Only remote start on a flat surface
- Have the parking brake fully engaged

Warning! It is the responsibility of the owner to ensure the parking/emergency brake properly functions. Failure to do so can result in personal injury or property damage. We recommend the owner have the parking/emergency brake system inspected and adjusted by a qualified automotive shop biannually.

Use of this product in a manner contrary to its intended mode of operation may result in property damage, personal injury, or death. (1) Never remotely start the vehicle with the vehicle in gear, and (2) Never remotely start the vehicle with the keys in the ignition. The user must also have the neutral safety feature of the vehicle periodically checked, wherein the vehicle must not remotely start while the car is in gear. This testing should be performed by an authorized Directed dealer in accordance with the Safety Check outlined in the product installation guide. If the vehicle starts in gear, cease remote start operation immediately and consult with the authorized Directed dealer to fix the problem.

After the remote start module has been installed, contact your authorized dealer to have him or her test the remote start module by performing the Safety Check outlined in the product installation guide. If the vehicle starts when performing the Neutral Safety Shutdown Circuit test, the remote start unit has not been properly installed. The remote start module must be removed or the installer must properly reinstall the remote start system so that the vehicle does not start in gear. All installations must be performed by an authorized Directed dealer.

OPERATION OF THE REMOTE START MODULE IF THE VEHICLE STARTS IN GEAR IS CONTRARY TO ITS INTENDED MODE OF OPERATION. OPERATING THE REMOTE START SYSTEM UNDER THESE CONDITIONS MAY RESULT IN PROPERTY DAMAGE OR PERSONAL INJURY. YOU MUST IMMEDIATELY CEASE THE USE OF THE UNIT AND SEEK THE ASSISTANCE OF AN AUTHORIZED Directed DEALER TO REPAIR OR DISCONNECT THE INSTALLED REMOTE START MODULE. DIRECTED WILL NOT BE HELD RESPONSIBLE OR PAY FOR INSTALLATION OR REINSTALLATION COSTS.

This product is designed for fuel injected vehicles only. Use of this product in a standard transmission vehicle must be in strict accordance with this guide.

This product should **not** be installed in any convertible vehicles, soft, or hard top with a manual transmission. Installation in such vehicles may pose certain risk.

What's included

- Two five-button/1-way Supercode remotes
- The control module (installed out-of-sight)
- Control center with integrated status LED and Valet override switch
- A remote start defeat toggle switch
- Window decals
- Your warranty registration

Important information

Congratulations on the purchase of your state-of-the-art remote start and keyless entry system. Due to the complexity of this system, it must be installed by an authorized dealer only. Installation of this product by anyone other than an authorized dealer voids the warranty. All dealers are provided with a preprinted dealer certificate to verify authorization.

By carefully reading this Owner's Guide prior to using your system, you will maximize the use of this system and its features. You can print additional or replacement copies of this manual by accessing our web site at www.directed.com.

► Your warranty

Your warranty registration must be completely filled out and returned within 10 days of purchase. Your product warranty will not be validated if your warranty registration is not returned. Make sure you receive the warranty registration from your dealer. It is also necessary to keep your proof of purchase, which reflects that the product was installed by an authorized dealer.

► Replacement remote controls

Your system comes with two, remote controls (P/N 7153X). If additional remotes are desired, please see your authorized dealer or visit www.directedstore.com to order.

► System maintenance

The system requires no specific maintenance. Your remotes are powered by small coin cell lightweight 3-volt lithium batteries that last approximately one year under normal use. The remote uses one CR2032 cell battery. When the battery begins to weaken, the operating range is reduced.

► Low battery indicator

When the batteries are low on the remote the vehicle system emits an additional honk when unlocking to let you know its time to change the battery.

Note: The optional horn honk should be installed, for the system to emit any additional honks during unlocking. Ask your authorized dealer if you have any questions.

► Battery replacement

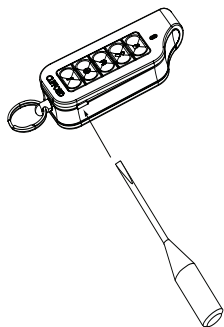

1. Using a small slotted screwdriver, insert into slot located as shown and carefully pry the front of the unit open until front is completely separated from housing.

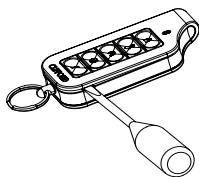



2. Turn both the unit front and circuit board over, remove battery from clip and replace.

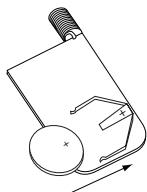

Note: Verify that the battery polarity is correct when replacing.

3. Reposition all parts and snap together.

► Two car operation

You can use the remote control system for two cars, with full command capability for both vehicles.

To change the car selection:

- Press and hold the **f** button for 3 seconds until the amber LED blinks once or twice indicating the current vehicle:
One blink: Car 1
Two blinks: Car 2
- To scroll from one car to the other, press the **f** button again. After selecting the car, operation resumes. The selected car remains selected until the setting is changed.



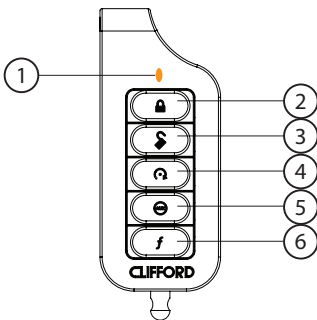

1-way remote



Feature	Description	
1	Transmit indicator	
2	Lock button	Press for one second to lock.
3	Unlock button	Press for one second to unlock.
4	Remote start button	Press for one second to activate remote start.
5	Auxiliary button	Press and hold for 1.5 second to activate optional trunk release.
6	Function button	Allows access to programming and modifies operation of the other buttons.

Note: If Keypad Lock is On, press **f and then press **🔓** to exit.**

► Transmitter configuration

Level Button	Direct Access	f x 1	f x 2	f x 3	f x 4
	Lock	Silent Lock			
	Unlock	Silent Unlock	Valet Mode	Car Finder	
	Remote Start	Reset Runtime	Timer Mode	Smart Start	Rear Defogger
	Trunk Release	AUX 1	AUX 2	AUX 3	
	Function Shift				

► Feature list

Unlock

Command: Press one time to Lock

Notes: Press/hold for 1.5 seconds to lock the system and then activate the Panic output*

Unlock

Command: Press one time to Unlock

Remote Start

Command: Press one time to activate Remote Start

Aux (trunk)

Command: Press and hold for 1.5 seconds to open trunk.

Function shift

Command: Press 1 to 4 times. (See Function shift table)

Notes: Each Press then release, shifts the function of the command button.

Silent lock

Command: Press **f** one-time and then press 

Notes: Locks the system without horn honks*

Silent unlock

Command: Press **f** one-time and then press 

Notes: Unlocks the system without horn honks*

* Horn honk is an optional feature. The panic and horn honk feature is available when this option is installed.

Runtime reset

Command: Press **f** one-time and then .

Notes: Re-starts the remote start runtime counter if remote start is active.

Aux 1

Command: Press **f** one time and then press .

Notes: This is an optional feature. See your sales rep/installer for details.

Valet mode

Command: Press **f** two-times and then .

Notes: Prevents the system from automatically activating the Failsafe Starter Kill and locking the door passively.

Timer mode

Command: Press **f** two-times and then .

Notes: Enables or disables the remote start timer mode.

Aux 2

Command: Press **f** two times and then press .

Notes: This is an optional feature. See your sales rep/installer for details.

Car finder

Command: Press **f** three-times and then .

Notes: The vehicle emits 1 long horn honk and the parking lights flash 10 times. Lock/Unlock cancels the parking light flashes.

Smart start

Command: Press **f** three-times and then press .

Notes: Enables or disables the Smart Start feature. The parking lights flash fast 5 times when turning the feature on, and flash slowly 5 times when turning the feature off.

Aux 3

Command: Press **f** three times and then press .

Notes: This is an optional feature. See your sales rep/installer for details.

Rear defogger

Command: Press **f** four times, and then . (after remote start is on.)

Notes: Manually turns on the defogger when remote start is on.

Panic

Command: Press and hold  for 1.5 seconds.

Notes: Panic is available when the optional horn honk feature is installed.

Using the system

► Locking the vehicle

To lock the vehicle, press the  button on the remote control.

The horn in the vehicle "honks" one-time, and the parking lights flash one-time. If the power door locks have been connected, the doors lock.

The system automatically checks for errors when it locks.

If errors are found when locking:

If the door is open when you lock the vehicle, the horn honks once and the parking lights flash. The horn then honks a second time to indicate that the door is open and the LED on the control center flashes in groups of three

Note: The optional horn honk and door input has to be installed for this function.

Locking without the honk (Silent Lock)

Press the **f** button on the remote one-time, and then press the  button. The vehicle locks without the confirmation honk. The parking lights flash one-time.

► Unlocking the vehicle

Lock the vehicle normally. Press the  button one time. The vehicle horn honks two-times and the parking lights flash.

UnLocking without the honk (Silent Unlock)

Lock the vehicle normally. Press the **f** button on the remote one-time, and then press the  button. The vehicle unlocks without the confirmation honk. The parking lights flash two-times.

► Valet mode

You can prevent your system from automatically activating the Failsafe® Starter Kill. When the system is in Valet mode, the feature is disabled. The doors do not automatically lock. This is useful when washing or having the vehicle serviced.

To enter or exit valet mode with the valet/program switch:



1. Turn the ignition key on and then off.

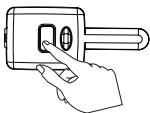

2. At anytime during the next 10 seconds, press and release the Valet switch on the control center. The LED lights constantly if you have entered Valet® Mode, and goes out if you have exited Valet Mode.

To enter or exit Valet mode with the remote control:

Press **f** two times, and then **🔒** to set the system in or out of Valet Mode. Repeating the process takes the system out of Valet Mode.

The control center LED come on solid when in Valet Mode and shuts off when exiting Valet Mode.

► Panic Mode

If you are threatened in or near your vehicle, you can attract attention by triggering the system with your remote. This feature is only available if the optional horn honk is connected.

- Press **🔒** for 2 seconds, to enter Panic Mode. The horn honks and the parking lights flash for the programmed horn honk duration.
- To stop Panic Mode at any time:
Press **🔒** on the remote again.



► Remote feature programming

The remote control has a menu for programming user features. Before you start make sure the keypad is unlocked. (See page 12)

To program the remote user features:

1. Press and hold the **f** button on the remote for 12 seconds. (ignore the car indicator at 3 seconds). The remote transmit LED turns on solid to indicate the Main Menu.
2. Press and hold the  button for 1.5 seconds: The remote LED blinks two-times. You are now in the Remote Configuration menu. From this menu you can now configure the remote's keypad lock features, as described in the following steps.

To configure the remote keypad lock features:

Press the  button to change the Auto keypad lock feature. Every press of the  button will cycle the setting from On to Off.

- When the remote LED blinks once the keypad automatically locks 60 seconds after the last button operation to avoid accidental command operations. When the keypad is locked, if any command button is pressed the remote will not transmit and the LED will not blink.
- When the remote LED blinks twice, the keypad lock feature is Off. The remote will transmit every time a command button is pressed.

If the keypad lock is On, press **f**, and then press  to unlock the keypad.

► Overriding the optional starter kill

To bypass the optional starter kill without a remote control:

Use your override switch located on the control center (see diagram below) to bypass the system. This switch bypasses the system only if you have the vehicle key.

To check proper operation:

1. While the vehicle is locked, open the door. Immediately insert the key into the ignition and turn it to the Run or On position. (all the indicators in the dash turn on)
2. Press and release the Override Switch one time. The LED on the control center will stop flashing and the optional starter kill is bypassed. You can now start the vehicle with the key.

Note: The override switch feature allows you to select a specific number of presses needed to disable the system. If the override switch has been programmed to a new number of presses by your authorized dealer, that number should be indicated below.

Override Switch number of presses _____

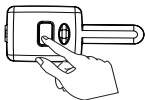

Using the remote start

Read this user guide, including the **Warnings** section at the beginning of this guide before using the remote start. Ensure that the vehicle is parked in an open area, not in a garage. To use your remote start to pre-warm or pre-cool your vehicle, remember to set the climate controls to the desired settings before shutting Off the engine.

To remote start your vehicle:

- Press the  button on the remote control. The vehicle parking lights flash. The vehicle remote starts and stays running for the programmed run time.

The preset remote start run time is 12 minutes. This can be changed to between 12 and 60 minutes (see your authorized dealer for programming changes).

Points to remember

If the hood is open or if the brake pedal is pressed, the vehicle will not remote start. **The remote start shuts down:**

- When the brake pedal is pressed
- The hood is opened
- When the remote start command is sent again from a remote control
- When runtime expires

► Manual transmission vehicles

If the vehicle has manual transmission the proper steps must be followed before leaving the parked vehicle, or the remote start feature is disabled. This process is called MTS, manual transmission start.

1. While the vehicle is running, put the transmission in neutral.
2. Press the vehicle's foot brake.
3. Apply the emergency brake.
4. Release the vehicle's foot brake.
Note: Pressing the brake again after this step will disable the remote start feature.
5. Using the remote control, activate the remote start within 15 seconds. The parking lights flash 5-times confirming that the remote start is active.
6. If the parking lights do not flash 5 times, you have not entered manual transmission mode and will need to repeat steps 1 thru 5.
7. Turn Off the ignition (the car should stay running when key is turned Off).
8. Exit the vehicle.
9. Lock the doors with the remote. (the vehicle should shut Off when locking the system).

You can now remote start the vehicle. If a door is opened before the next remote start activation, the system will not remote start.

To drive your automatic or manual transmission vehicle after it has been remote started:

1. Get in without stepping on the brake.
2. Insert the ignition key and turn it to the On position.
3. Now, step on the brake.

You have now taken direct control from the remote start system.

► Timer mode

This unit can be programmed to start and run the engine every three hours, for a maximum of six cycles. The engine will run for the programmed run time and then shut down. After three hours, the system will restart the engine.

Note: This feature works only when the system has been locked with the remote.

Important: Timer Mode should be used in open areas **only**. Never start and run the vehicle in an enclosed space such as a garage or carport.

To activate timer mode with an automatic transmission:

1. Press **f** twice and then press .
2. The parking lights quickly flash four times to confirm timer mode entry. (The vehicle will not remote start at this point.)
3. The vehicle begins the timer mode sequence.

To activate timer mode with a manual transmission:

1. Enter the MTS mode.
2. Exit the vehicle and lock the system.
3. Enter the timer mode. The parking lights quickly flash 4 times to confirm entry into timer mode (vehicle will not remote start at this point). The vehicle begins the timer mode sequence.

Timer Mode is exited automatically after the sixth run cycle. The parking lights slowly flash 4 times when exiting timer mode.

To exit timer mode with the transmitter:

- Press the **f** button twice and then press . The parking lights flash slow four times to confirm timer mode is exited.

To exit timer mode without the transmitter:

1. Make sure the remote start system is not operating the engine.
2. Turn the ignition on. Timer Mode is exited and the parking lights flash slowly four times.

Note: The Bitwriter can change the amount of times the remote start activates and, it can change the intervals between activations in timer mode.

► Turbo timer mode

Turbo timer mode keeps the engine running after arriving at your destination for a programmable period of 1, 3, 5 or 10 minutes. This allows the system's timer to conveniently cool down the turbo after you have left the vehicle.

To activate turbo timer mode with automatic transmission:

1. Make sure turbo timer is turned on.
2. Open the vehicle door.
3. While the vehicle is running, press **f** button 2-times, and then press  button. The parking lights flash one-time confirming that the remote start is activated.
4. Turn Off the ignition. The car remains running.
5. Exit the vehicle and Lock the system. The vehicle remains running for the programmed run time.

To enter turbo timer mode with a manual transmission:

Perform the manual transmission procedure (See p. 22) with the door open. Transmit the timer mode feature with the remote by pressing **f** two-times, and then press .

After exiting the vehicle, lock the system and the vehicle remains running for the programmed runtime. (The remote start feature is still enabled).

You can still remote start the vehicle after the turbo timer has timed out and shut Off the vehicle. For safety reasons, if a door is opened (while the system is Locked or Unlocked) while you are away, the remote start exits the manual transmission mode and will not remote start until the MTS sequence is re-initiated.

Note: An optional push button can be hardwired to the (-) activation input (H1/10) on the remote start module if you want to activate the turbo timer without using the remote.

When the vehicle is running follow the procedures listed above, but instead of pressing the remote, press the push button the appropriate number of times to activate the remote start (factory setting is for 1 pulse). After which you can turn Off the ignition and exit the vehicle. The car remains running for the pre-programmed amount of time.

► Smart start activation

With Smart Start the remote start automatically activates when the vehicle reaches a certain temperature, or when it reaches a certain voltage.

Note: This feature works only when the system has been locked with the remote.



The factory setting for temperature high is 100°, and the low is 0° (F). The voltage setting is 10.5v. These settings can be adjusted or turned off by your installer using the Bitwriter.

To activate Smart Start mode:

- Press the **f** button on the remote 3 times and then press the  button.

The parking lights flash 5 times **fast** to confirm the remote is in Smart Start mode.

To activate Smart Start mode with a manual transmission:

1. Enter the MTS procedure.
2. Exit the vehicle and press the  button on the remote (the vehicle shuts down when locking).
3. Press the **f** button on the remote 3 times and then press the  button. The parking lights flash 5 times **fast** to confirm the remote is in Smart Start mode.

When Smart Start is activated the system checks the vehicles voltage or internal temperature, based on the programmed timer mode settings. (every 3 hours for a total of 6 remote start cycles) If there are any changes to timer mode, the Smart Start monitoring is also affected.

For example:

When Smart Start is activated, the system checks the vehicle's voltage and internal temperature every 3 hours. If thresholds have been met or exceeded, the remote start activates and runs for the programmed duration. This is counted as one remote start activation, with five remote start activations remaining. Voltage and temperature thresholds are checked again in 3 hours, and if thresholds have NOT been met remote start does not activate, and there are five remote starts remaining.

Use one of the below methods to exit Smart Start mode:

- Perform the same steps you followed to activate Smart Start mode
- Turn the ignition On
- Press the brake pedal

The parking lights flash 5 times **slowly** to confirm the remote has exited Smart Start mode.

► Turning on the rear defogger

The rear defogger (if connected) is programmed to automatically activate when remote start is turned on. If the interior cabin temperature is above 55° F the defogger will not activate.

To manually activate the rear defogger after remote start is on:

- Press **f** four times, and then press . The parking lights flash 4 times to confirm the defogger activation.

► Valet take-over

The Valet take-over feature allows the vehicle to remain running after the key has been removed from the ignition. This feature is useful for occasions when you want to exit and lock the vehicle for short periods of time, but would like to leave the motor running and the climate controls on.

To perform Valet take-over:

1. Before turning Off the engine, press and release the  button on the transmitter.
The parking lights flash one time to confirm that valet -take-over has been initiated Then wait a few seconds.
2. Turn the ignition key to the Off position (The engine remains running).
3. Exit the vehicle and lock the system with the remote.
The engine runs until the pre-programmed time elapses or a shut-down input is received.

Note: To enable valet take-over with a manual transmission, open the door when going into MTS mode. The parking lights flash five-times to confirm entry into valet takeover. After you exit the vehicle you can lock the system with the remote and the car remains running. If the vehicle shuts down when locking, then the unit did not enter the valet take-over mode.

Safety features

This system has several important safety features to ensure proper operation of the motor and prevent accidental damage to the engine or its components.

➤ Optional starter anti-grind circuitry

Whenever the vehicle is remote started, advanced anti-grind circuitry prevents the starter from engaging, even if the key is turned to the start position. This prevents damage to the starter motor if the key is turned to the start position during remote start operation.

Note: Anti-grind circuitry only works when the remote start system is operating the motor and the optional Failsafe® Starter Kill relay is installed.

➤ Disabling the remote start system

This feature allows the remote start unit to be temporarily disabled to prevent the vehicle from being remote started accidentally. This feature is useful when the vehicle is being serviced or stored in an enclosed area.

To disable the remote start, move the shutdown toggle switch to the Off position. Check with your installer for the location of the shutdown switch.
Location of Shutdown Switch _____

Diagnostics

The microprocessor at the heart of the system is constantly monitoring the switches that are connected to the main unit.

► Locking

If the system is locked at the same time that the door input is active, you will hear one horn honk to indicate locking, and then a second horn honk to indicate Bypass Notification.

Note: Bypass Notification does not occur if the optional horn and door input is not installed or when the system is in Silent Mode or if the notification honks have been programmed Off by the installer.

► Unlocking

Extra honks when unlocking the system is a notification that the batteries in the remote are low and need to be replaced.

Important: The optional horn honk feature must be installed.

► Remote start

This system can provide you with information to indicate what the problem is when using the remote start. When the remote start is activated and fails to engage, count the parking light flashes to determine the problem. The parking lights will flash between 5 - 8 times to indicate what caused the no start situation.

- 5 flashes: brake wire is active
- 6 flashes: hood pin is active
- 7 flashes: manual transmission mode is enabled and not initialized
- 8 flashes: neutral safety wire has no ground or the remote start defeat toggle switch is off.

Keep a record of the number of flashes, to assist your installer when taking the vehicle in for service.

Owner recognition

Owner recognition lets up to four users of the system have unique settings to meet their specific needs. It is almost like having four separate systems in your vehicle, one for each user. This feature is only available to authorized dealers using the Bitwriter or Bitwriter 2 program tool.

Rapid resume logic

This Directed system will store its current state to non-volatile memory. If power is lost and then reconnected the system will recall the stored state from memory.

For example, if the unit is in Valet Mode and the battery is disconnected for any reason, such as servicing the car, when the battery is reconnected the unit is still in Valet Mode. This applies to all states of the system including lock or unlock.

Power saver mode

Your system will automatically enter Power Saver Mode while locked or in Valet Mode, after a period of time in which no operation has been performed. This lowers the current draw on the vehicle's battery. Power Saver Mode takes over under the following conditions:

Power Saver when the system is locked: After the system has been Locked for 24 hours the status LED on the control center flashes at half its normal rate, decreasing the system's current draw.

Power Saver in Valet Mode: When the system enters Valet Mode the Status LED on the control center illuminates steadily. If the vehicle is not used (ignition is not turned on) for a one-hour period while the system is in Valet Mode, the status LED shuts Off. If the system remains in Valet Mode, the LED comes back on the next time the ignition is turned On, and then Off.

Programming options

Your system has many custom programmable options. Some may require installation labor. Ask your authorized dealer for details.

The following is a list of the programmable options, with the factory settings in **Bold**.

- **Active** locking (remote only) passive locking, the system automatically locks the doors 30-seconds after the last door is closed; or Auto Re-lock automatically re-locks the doors 60 seconds after unlocking (if no door is opened).
- Locking/Unlocking with no horn honk confirmations **On** or Off.
- Ignition controlled door lock feature On or **Off**: When this feature is programmed on, the doors lock three seconds after the ignition is turned on, and unlock when the ignition is turned Off. The ignition lock and unlock are independent features that can be programmed separately.
- **Panic mode enabled**/disabled when the ignition is turned on or completely turned Off.
- **Comfort closure** is a programming option which closes the vehicle's windows after remote locking. **Note**: Comfort closure can only be used on cars that have the capability of closing the windows (and on some cars the sunroof as well) with the key cylinder in the door.

Convenience expansions

Listed below are some of the expansion options available. Please consult your dealer for a complete explanation of all the options available to you.

Power Trunk Release: The accessory output of the system can operate a factory power release for the vehicle's trunk or hatch. Sometimes an optional relay is required. If the factory release is not power-activated, Directed®'s 522T trunk release solenoid can often be added.

Power Window Control: Automatic power window control is provided with the 529T and 530T systems. These can operate power windows, and can roll them up automatically when the system is Locked, roll them down, or both up and down.

Glossary of terms

Control Center: The control center contains the system's radio-frequency antenna, the valet and override switch, and the Status LED. For maximum remote-control range, the Control Center is usually located at the top of the windshield, centered near the rear-view mirror.

Control Module: The "brain" of your system. Usually hidden underneath the dash area of the vehicle. It houses the microprocessor which monitors your vehicle and controls all of the system's functions.

Failsafe® Starter Kill (if equipped): An automatic switch controlled by the system which prevents the vehicle's starter from cranking whenever the system is locked. The vehicle is never prevented from cranking when the system is unlocked in Valet® Mode, or should the starter kill switch fail. Your system is ready for this feature, however installation of this feature may require additional labor.

Input: Any physical connection to the system. An input can be provided by existing systems in the vehicle, such as ignition or courtesy lights.

In-vehicle status LED: A light used to indicate the status of your system. It is located on your systems control center.



MTS: Manual transmission start. Procedure required for using the remote start in a vehicle with a manual transmission.

RF: Radio frequency

Valet Button: A small push button switch located on your systems control center. It is used to override the starter interrupt when a remote is lost or damaged, or to enter or exit Valet Mode.





Quick reference guide

- **Locking**
To lock press  for one second. The doors lock.
The LED on the control center flashes and the horn honks one time. (if connected). The parking lights flash once to confirm locking.
- **Unlocking**
To unlock press . The doors unlock, and the horn honks (if connected) two times. LED flashes for one-second. The parking lights flash two times to confirm unlocking.
- **Bypassing the optional starter kill without a remote**

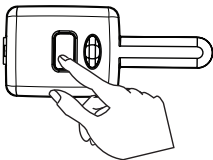

Turn on the ignition. Press and release the Valet button within 15 seconds. The system should now bypass. If it does not, you may have waited too long or pressed the button incorrect number of times.





Number of Valet button presses for disabling _____

- **Silent Lock**
Press **f** one-time and then press . The doors lock. The LED on the control center flashes and the parking lights flash once to confirm locking.
- **Silent UnLock**
Press **f** one-time and then press  for one-second. The doors unlock the parking lights flash twice to confirm unlocking.



- Remote Start
Press . The parking lights turns on (if connected). The vehicle starts and runs for the programmed duration.
- Rear Defogger
Press **f** four-times, and then press  (only after remote start is On.) The parking lights flash 4 times confirming activation of the defogger output.
- To disable the remote start system
Move the shutdown toggle switch to the Off position.

Location of Shutdown Toggle Switch _____

- Valet Mode
Press **f** two-times and then . The LED on the control center comes on solid to indicate the system is in valet. The same sequence on the remote can be used to exit valet mode. The LED turns off when valet mode is exited.
- Valet take-over
 1. Before turning Off the engine, press and release the  button. Then wait a few seconds.
 2. Turn the ignition key to the Off position.
 3. Exit the vehicle and lock the doors with the remote.
The engine will remain running until the programmed time elapses or a shut-down input is received.

Limited lifetime consumer warranty

Directed Electronics. ("Directed") promises to the original purchaser to repair or replace (at Directed's election) with a comparable reconditioned model any Directed unit (hereafter the "unit"), excluding without limitation the siren, the remote transmitters, the associated sensors and accessories, which proves to be defective in workmanship or material under reasonable use during the lifetime of the vehicle provided the following conditions are met: the unit was purchased from an authorized Directed dealer, the unit was professionally installed and serviced by an authorized Directed dealer; the unit will be professionally reinstalled in the vehicle in which it was originally installed by an authorized Directed dealer; and the unit is returned to Directed, shipping prepaid with a legible copy of the bill of sale or other dated proof of purchase bearing the following information: consumer's name, telephone number and address; the authorized dealers name, telephone number and address; complete product description, including accessories; the year, make and model of the vehicle; vehicle license number and vehicle identification number. All components other than the unit, including without limitation the siren, the remote transmitters and the associated sensors and accessories, carry a one-year warranty from the date of purchase of the same. ALL PRODUCTS RECEIVED BY DIRECTED FOR WARRANTY REPAIR WITHOUT PROOF OF PURCHASE WILL BE DENIED. This warranty is non-transferable and is automatically void if: the original purchaser has not completed the warranty card and mailed it within ten (10) days from the date of purchase to the address listed on the card; the unit's date code or serial number is defaced, missing or altered; the unit has been modified or used in a manner contrary to its intended purpose; the unit has been damaged by accident, unreasonable use, neglect, improper service, installation or other causes not arising out of defects in materials or construction. The warranty does not cover damage to the unit caused by installation or removal of the unit. Directed, in its sole discretion, will determine what constitutes excessive damage and may refuse the return of any unit with excessive damage.

TO THE MAXIMUM EXTENT ALLOWED BY LAW, ALL WARRANTIES, INCLUDING BUT NOT LIMITED TO EXPRESS WARRANTY, IMPLIED WARRANTY, WARRANTY OF MERCHANTABILITY, FITNESS FOR PARTICULAR PURPOSE AND WARRANTY OF NON-INFRINGEMENT OF INTELLECTUAL PROPERTY, ARE EXPRESSLY EXCLUDED; AND DIRECTED NEITHER ASSUMES NOR AUTHORIZES ANY PERSON OR ENTITY TO ASSUME FOR IT ANY DUTY, OBLIGATION OR LIABILITY IN CONNECTION WITH ITS PRODUCTS. DIRECTED DISCLAIMS AND HAS ABSOLUTELY NO LIABILITY FOR ANY AND ALL ACTS OF THIRD PARTIES INCLUDING ITS AUTHORIZED DEALERS OR INSTALLERS. DIRECTED SECURITY SYSTEMS, INCLUDING THIS UNIT, ARE DETERRENTS AGAINST POSSIBLE THEFT. DIRECTED IS NOT OFFERING A GUARANTEE OR INSURANCE AGAINST VANDALISM, DAMAGE OR THEFT OF THE AUTOMOBILE, ITS PARTS OR CONTENTS; AND HEREBY EXPRESSLY DISCLAIMS ANY LIABILITY WHATSOEVER, INCLUDING

WITHOUT LIMITATION, LIABILITY FOR THEFT, DAMAGE AND/OR VANDALISM. THIS WARRANTY DOES NOT COVER LABOR COSTS FOR MAINTENANCE, REMOVAL OR REINSTALLATION OF THE UNIT OR ANY CONSEQUENTIAL DAMAGES OF ANY KIND. IN THE EVENT OF A CLAIM OR A DISPUTE INVOLVING DIRECTED OR ITS SUBSIDIARY, THE VENUE SHALL BE SAN DIEGO COUNTY IN THE STATE OF CALIFORNIA. CALIFORNIA STATE LAWS AND APPLICABLE FEDERAL LAWS SHALL APPLY AND GOVERN THE DISPUTE. THE MAXIMUM RECOVERY UNDER ANY CLAIM AGAINST DIRECTED SHALL BE STRICTLY LIMITED TO THE AUTHORIZED DIRECTED DEALER'S PURCHASE PRICE OF THE UNIT. DIRECTED SHALL NOT BE RESPONSIBLE FOR ANY DAMAGES WHATSOEVER, INCLUDING BUT NOT LIMITED TO, ANY CONSEQUENTIAL DAMAGES, INCIDENTAL DAMAGES, DAMAGE TO VEHICLE, DAMAGES FOR THE LOSS OF TIME, LOSS OF EARNINGS, COMMERCIAL LOSS, LOSS OF ECONOMIC OPPORTUNITY AND THE LIKE. NOTWITHSTANDING THE ABOVE, THE MANUFACTURER DOES OFFER A LIMITED WARRANTY TO REPLACE OR REPAIR THE CONTROL MODULE SUBJECT TO THE CONDITIONS AS DESCRIBED HEREIN. THIS WARRANTY IS VOID IF THE UNIT HAS NOT BEEN PURCHASED FROM DIRECTED, OR AN AUTHORIZED DIRECTED DEALER, OR IF THE UNIT HAS BEEN DAMAGED BY ACCIDENT, UNREASONABLE USE, NEGLIGENCE, ACTS OF GOD, NEGLIGENCE, IMPROPER SERVICE, OR OTHER CAUSES NOT ARISING OUT OF DEFECT IN MATERIALS OR CONSTRUCTION.

Some states do not allow limitations on how long an implied warranty will last or the exclusion or limitation of incidental or consequential damages. This warranty gives you specific legal rights and you may also have other rights that vary from State to State.

This warranty is only valid for sale of product(s) within the United States of America. Product(s) sold outside of the United States of America are sold "AS-IS" and shall have NO WARRANTY, express or implied. This product may be covered by a Guaranteed Protection Plan ("GPP"). See your authorized Directed dealer for details of the plan or call Directed Customer Service at 1-800-876-0800.

Make sure you have all of the following information from your authorized Directed dealer:

A clear copy of the sales receipt, showing the following:

- o Date of purchase
- o Your full name and address
- o Authorized dealer's company name and address
- o Type of alarm installed
- o Year, make, model and color of the automobile
- o Automobile license number
- o Vehicle identification number
- o All security options installed on automobile
- o Installation receipts

920-0003 06-06

The company behind this system is Directed Electronics

Since its inception, Directed Electronics has had one purpose, to provide consumers with the finest vehicle security and car stereo products and accessories available. The recipient of nearly 100 patents and Innovations Awards in the field of advanced electronic technology.

Directed is ISO 9001 registered.

Quality Directed Electronics products are sold and serviced throughout North America and around the world.

Call (800) 274-0200 for more information about our products and services.

Designed and Engineered in the USA

Directed[®]
E L E C T R O N I C S

G4102X 2008-09

Vista, CA 92081
www.directed.com

© 2008 Directed Electronics—All rights reserved

Free Manuals Download Website

<http://myh66.com>

<http://usermanuals.us>

<http://www.somanuals.com>

<http://www.4manuals.cc>

<http://www.manual-lib.com>

<http://www.404manual.com>

<http://www.luxmanual.com>

<http://aubethermostatmanual.com>

Golf course search by state

<http://golfingnear.com>

Email search by domain

<http://emailbydomain.com>

Auto manuals search

<http://auto.somanuals.com>

TV manuals search

<http://tv.somanuals.com>