

SIZE : 148 X 210mm



## DVD HOME THEATER SYSTEM



**CD-R CD-RW**

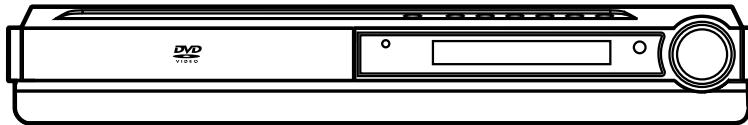

**OWNER'S MANUAL**



# IMPORTANT SAFETY INSTRUCTIONS



**WARNING: TO REDUCE THE RISK OF ELECTRIC SHOCK, DO NOT REMOVE COVER (OR BACK). NO USER-SERVICEABLE PARTS INSIDE. REFER SERVICING TO QUALIFIED SERVICE PERSONNEL.**

**WARNING: TO PREVENT FIRE OR SHOCK HAZARD, DO NOT EXPOSE THIS APPLIANCE TO RAIN OR MOISTURE.**

**CAUTION: TO PREVENT ELECTRIC SHOCK, MATCH WIDE BLADE OF PLUG TO WIDE SLOT, FULLY INSERT.**

## ***On Placement***

- The apparatus shall not be exposed to dripping or splashing.
- Do not use the Unit in places which are extremely hot, cold, dusty, or humid.
- Place the Unit on a flat and even surface.
- Do not restrict the air flow of the Unit by placing it in a place with poor air flow, by covering it with a cloth, or by placing it on carpeting.

## ***FCC Information***

This device complies with Part 15 of FCC Rules.

Operation is subject to the following two conditions:

- (1) This device may not cause harmful interference, and
- (2) This device must accept any interference received, including interference that may cause undesirable operation.

## ***On Safety***

- When connecting or disconnecting the AC cord, grip the plug and not the cord itself. Pulling the cord may damage it and create a hazard.
- When you are not going to use the Unit for a long period of time, disconnect the AC power cord.

## ***On Condensation***

- When left in a heated room where it is warm and damp, water droplets or condensation may form inside the Unit. When there is condensation inside the Unit, the Unit may not function normally. Let the Unit stand for 1 to 2 hours before turning the power on, or gradually heat the room up and dry the Unit before use.

### **WARNING:**

- Should any trouble occur, disconnect the AC power cord and refer servicing to a qualified technician.
- Do not place anything directly on the top of the Unit. Damage to the Unit can result.

## ***Notes on Copyright***

It is forbidden by law to copy, broadcast, show, broadcast on cable, play in public, rent copyrighted material without permission.

Apparatus Claims of U.S. Patent Nos. 4,631,603; 4,577,216; 4,819,098 and 4,907,093 licensed for limited viewing uses only.

DVD video discs are copy protected, and any recordings made from these discs will be distorted. This product incorporates copyright protection technology that is protected by method claims of certain U.S. patents and other intellectual property rights owned by Macrovision Corporation and other rights owners. Use of this copyright protection technology must be authorized by Macrovision Corporation, and is intended for home and other limited viewing uses only, unless otherwise authorized by Macrovision Corporation. Reverse engineering or disassembly is prohibited.



The lightning flash with an arrowhead symbol, within the equilateral triangle, is intended to alert the user to the presence of uninsulated "dangerous voltage" within the product's enclosure that may be of sufficient magnitude to cause an electric shock.



The exclamation point within the equilateral triangle is intended to alert the user to the presence of important operating and maintenance (servicing) instructions in this owner manual.



This product contains a low power laser device.



The symbol for Class II (Double Insulation)

# Important Safety Instructions

1. **Read Instructions** - All the safety and operating instructions should be read before the appliance is operated.
2. **Retain Instructions** - The safety and operating instructions should be retained for future reference.
3. **Heed Warnings** - All warnings on the appliance and in the operating instructions should be adhered to.
4. **Follow Instructions** - All operating and use instructions should be followed.
5. **Water and Moisture** - The appliance should not be used near water - for example, near a bathtub, washbowl, kitchen sink, laundry tub, in a wet basement, or near a swimming pool, and the like.
6. **Carts and Stands** - The appliance should be used only with a cart or stand that is recommended by the manufacturer.
- 6A. An appliance and cart combination should be moved with care. Quick stops, excessive force, and uneven surfaces may cause the appliance and cart combination to overturn.
7. **Wall or Ceiling Mounting** - The appliance should be mounted to a wall or ceiling only as recommended by the manufacturer.
8. **Ventilation** - The appliance should be situated so that its location or position does not interfere with its proper ventilation. For example, the appliance should not be situated on a bed, sofa, rug, or similar surface that may block the ventilation openings; or, placed in a built-in installation, such as a book case or cabinet, that may impede the flow of air through the ventilation openings.
9. **Heat** - The appliance should be situated away from heat sources such as radiators, heat registers, stoves, or other appliances (including amplifiers) that produce heat.
10. **Power Sources** - The appliance should be connected to a power supply only of the type described in the operating instructions or as marked on the appliance.
11. **Grounding or Polarization** - Precautions should be taken so that the grounding or polarization means of an appliance are not defeated.
12. **Power-Cord Protection** - Power-supply cords should be routed so that they are not likely to be walked on or pinched by items placed upon or against them, paying particular attention to cords at plugs, convenience receptacles, and the point where they exit from the appliance.
13. **Cleaning** - The appliance should be cleaned only as recommended by the manufacturer.
14. **Power Lines** - An outdoor antenna should be located away from power lines.
15. **Outdoor Antenna Grounding** - If an outside antenna is connected to the receiver, be sure the antenna system is grounded so as to provide some protection against voltage surges and built up static charges. Section 810 of the National Electrical Code, ANSI/NFPA No. 70, provides information with respect to proper grounding of the mast and supporting structure, grounding of the lead-in wire to an antenna discharge unit, size of grounding conductors, location of antenna-discharge unit, connection to grounding electrodes, and requirements for the grounding electrode. See Figure 1.
16. **Nonuse Periods** - The power cord of the appliance should be unplugged from the outlet when left unused for a long period of time.
17. **Object and Liquid Entry** - Care should be taken so that objects do not fall, and liquids are not spilled, into the enclosure through openings.
18. **Damage Requiring Service** - The appliance should be serviced by qualified service personnel when:
  - A. The power-supply cord or the plug has been damaged; or
  - B. Objects have fallen, or liquid has been spilled, into the appliance; or
  - C. The appliance has been exposed to rain; or
  - D. The appliance does not appear to operate normally or exhibits a marked change in performance; or
  - E. The appliance has been dropped, or the enclosure damaged.
19. **Servicing** - The user should not attempt to service the appliance beyond that described in the operating instructions. All other servicing should be referred to qualified service personnel.

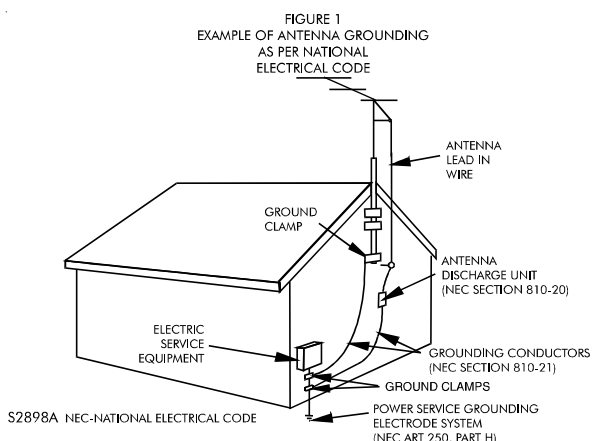

# TABLE OF CONTENTS

<b>Important Safety Instruction</b> .....	1-2	<b>Repeat Playback</b> .....	25
<b>Disc Formats</b> .....	4	Repeating a title/chapter (DVD) .....	25
<b>Before You Start</b> .....	5	Repeating a single track/whole disc (CD) .....	25
Using the remote control .....	5	Repeating a specific section (DVD) .....	25
<b>Parts and Functions</b> .....	6-8	<b>Playing MP3 and Picture CD</b> .....	26-27
Remote Control .....	6-7	Playing a MP3 file disc .....	26
Front Panel .....	8	Playing a Picture CD .....	27
<b>Display</b> .....	9	Playing a MP3/Picture CD .....	27
Front Panel Display .....	9	<b>Radio Operation</b> .....	28
Display Information .....	9	Tuning into a station manually .....	28
<b>Setup</b> .....	10-15	FM Stereo .....	28
For better reception .....	10	Weak FM stations .....	28
Connecting your TV .....	10	To search for a station automatically .....	28
Connecting a VCR .....	11	Presetting stations .....	28
Connecting to other equipment .....	12	Tuning into a preset station .....	28
Connecting the speakers & subwoofer .....	13	<b>Customizing the Function Settings</b> .....	29-36
Positioning the speakers & subwoofer .....	14	LANGUAGE setting .....	29
Mounting rear surround speakers .....	15	VIDEO setting .....	29-31
Turning on the Unit and TV .....	15	TV Shape .....	29
Power cord connection .....	15	Video Output .....	30
<b>Adjusting the Sound</b> .....	16-17	Brightness .....	31
<b>Playing a Disc</b> .....	18-20	Edges .....	31
Playing Disc .....	18	AUDIO setting .....	32-34
Pausing playback (still mode) .....	18	Digital Out .....	32
Stopping playback .....	18	L/R speaker .....	32
To skip to a different track .....	18	Subwoofer .....	33
Fast Forward/Fast Reverse .....	19	Surround Delay .....	33
Slow-motion play .....	19	Center Delay .....	34
Zooming into an image .....	19	Pink noise .....	34
Angle selection .....	20	RATING setting .....	35-36
Audio selection .....	20	Password/Parental Lock .....	35
Subtitle selection .....	20	Factory Set .....	36
<b>Special Functions</b> .....	21-23	<b>Language Code List for Disc Language</b> .....	37
Display function (DVD) .....	21	<b>Maintenance</b> .....	38
Locating a specific title .....	22	Cleaning Disc .....	38
Locating a specific title/chapter/track .....	22	Cleaning the Unit .....	38
Locating a specific time .....	23	Important Note .....	38
Angle setting .....	23	<b>Trouble Shooting Guide</b> .....	39
Audio setting .....	23		
Subtitle setting .....	23		
<b>CD/DVD programmable memory</b> .....	24		
DVD programmable memory .....	24		
Title/Chapter programmed playback .....	24		
CD programmable memory .....	24		
Track programmed playback .....	24		

# DISC FORMATS

The Unit can playback discs bearing any of the following marks:



DVDs  
[8cm(3")/12cm(5") disc]



**CD-R**  
Compatible



Audio CDs  
[8cm(3")/12cm(5") disc]



## Region Management Information

Region Management Information: This Unit is designed and manufactured to respond to the Region Management Information that is encoded on DVD discs. If the Region number printed on the DVD disc does not correspond to the Region number of this Unit, this Unit cannot play that disc.







The region number of this Unit is 1.

## Disc Function or Operation that is Not Available

When the  symbol appears on the TV screen, it indicates that the function or operation attempted is not available at that time. This occurs because the DVD disc manufacturer determines the specific functions. Certain functions may not be available on some discs. Be sure to read the documentation provided with the disc.

## Icons Used on DVDs

Sample Icons

	1. English 2. French	Language selections for audio
	1. English 2. French	Language selections for subtitles
	16:9	Screen aspect ratio
	2	Multiple camera angles
		Region code indicator

### Notes:

- This Unit supports 2-channel (L/R) audio and 5.1ch (Multi-channel) MPEG Audio 1/2 (only when the DIGITAL AUDIO OUT coaxial jack is used for connection). It does not support 7.1 channel MPEG Audio Version 2.0.
- When playing back a CD-G (Graphics) or CD EXTRA disc, the audio portion will be played, but the graphic images will not be shown.

## Title, Chapter and Tracks

- DVDs are divided into "titles" and "chapters". If the disc has more than one movie on it, each movie would be a separate "title". "Chapters" are sections of titles.

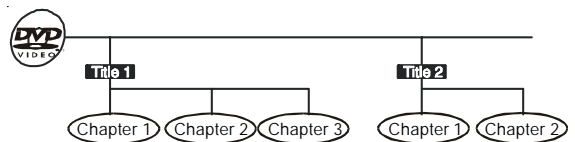

- Audio CDs are divided into "tracks". A "track" is usually one song on an Audio CD.

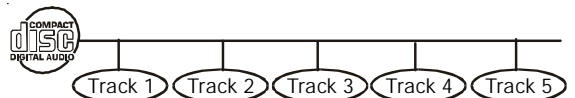

### Note :

- Numbers identify each title, chapter, and track on a disc. Most discs have these numbers recorded on them, but some do not.

### Notes on Unauthorized Discs

You may not be able to play back some DVD discs on this Unit if they were purchased from outside your geographic area or made for business purposes.

# BEFORE YOU START

## **Using the Remote Control**

- Point the Remote Control at the REMOTE SENSOR located on the Unit.
- When there is a strong ambient light source, the performance of the infrared REMOTE SENSOR may be degraded, causing unreliable operation.
- The recommended effective distance for remote operation is about 16 feet (5 meters).

## **To install Batteries**

1. Open the battery door.

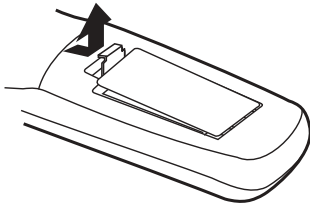

2. Insert two "AA" or UM-3 size batteries.

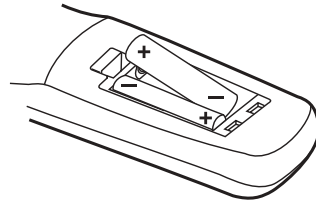

## **Battery Replacement**

When batteries become weak, the operating distance of the Remote Control is greatly reduced and you will need to replace the batteries.



### **Notes:**

- If the Remote Control is not going to be used for a long time, remove the batteries to avoid damage caused by battery leakage corrosion.
- Do not mix old and new batteries. Do not mix ALKALINE, standard (CARBON-ZINC) or rechargeable (NICKEL-CADMIUM) batteries.

# PARTS AND FUNCTIONS

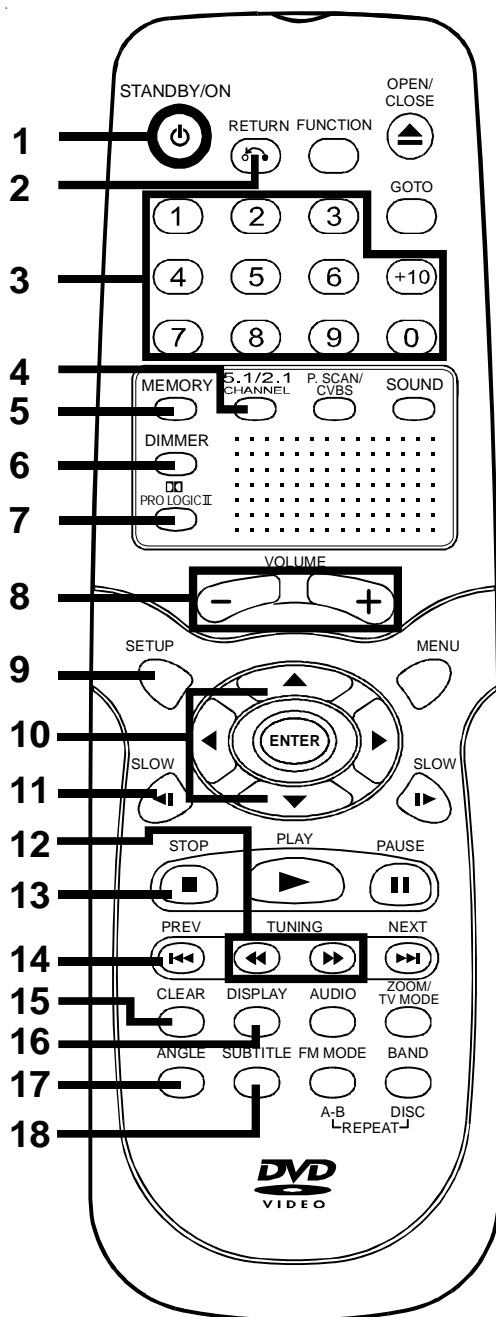
## Remote Control



- 1) **STANDBY / ON button**  
Turns the Unit on and puts it in standby mode.
- 2) **RETURN button**  
Return to the normal operation after using the SETUP menu.
- 3) **Number (0 - 9) and (+10) buttons**  
Use when creating programs, and entering a parental level password. To select numbers over 9, press +10 button and then the second no. for example, to enter 18, press +10 and then 8.
- 4) **5.1 / 2.1 CHANNELS button**  
Switch speaker output to 5.1 channel mode. (All speakers + subwoofer)  
Switch speaker outputs to 2.1 channel. (Front left/right speakers + subwoofer)
- 5) **MEMORY button**  
Enter the number of a selected chapter or track.  
Enter the number of a selected station.
- 6) **DIMMER button**  
Turns the display backlight ON and OFF.
- 7) **PRO LOGIC II button**  
In AV\_IN mode, switches to Dolby Pro Logic mode for VHS tapes encoded with Dolby Pro Logic.
- 8) **VOLUME (+ / -) buttons**  
Adjust the volume.
- 9) **SETUP button**  
Selects the SET UP menu screen.
- 10) **▲ / ▼ CURSOR buttons**  
Use to highlight selections on a menu screen and adjust certain settings.
- 11) **◀ SLOW button**  
Perform slow reverse playback of DVDs.
- 12) **◀◀ / ▶▶ TUNING buttons**  
◀◀ : Fast reverse playback.  
▶▶ : Fast forward playback.  
◀◀ TUNING ▶▶ : Scan all available radio stations.
- 13) **■ STOP button**  
Stop playback.
- 14) **◀◀◀ PREV button**  
Move reverse through titles, chapters or tracks on a disc.  
Tune to the presetted stations.
- 15) **CLEAR button**  
Clear input selections and cancel certain playback functions.
- 16) **DISPLAY button**  
Change disc status information displayed on the TV.
- 17) **ANGLE button**   
Switch the camera angle of the video presentation when scenes with multiple camera angles are recorded on a DVD.
- 18) **SUBTITLE button**   
Select one of the subtitle languages programmed on a DVD.

# PARTS AND FUNCTIONS

## Remote Control

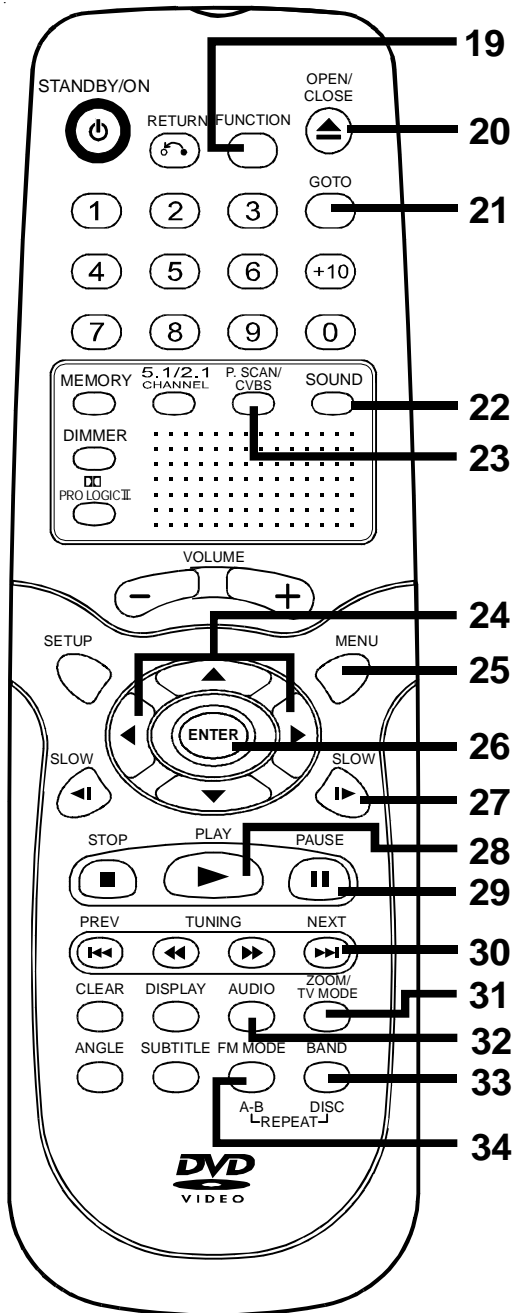

### 19) FUNCTION button

Display the FUNCTION screen where you can check or change various setting.

### 20) OPEN / CLOSE button

Use to open or close the disc tray.

### 21) GOTO button

Skip directly to a specific location on a DVD disc.

### 22) SOUND button

Selects sound balance and tone controls for adjustment with the cursor buttons.

### 23) P. SCAN / CVBS button

Changing YUV output to Progressive Scan Video mode or back to CVBS mode.

### 24) ◀/▶ CURSOR buttons

Use to highlight selections on a menu screen and make adjust certain settings.

### 25) MENU button

Open and close DVD's menu.

### 26) ENTER button

Confirm selections on a menu screen.

### 27) SLOW ▶ button

Perform slow forward playback of DVDs.

### 28) ▶ PLAY button

Start playback.

### 29) || PAUSE button

Pause playback, frame advance.

### 30) NEXT ▶▶ button

Move forward through titles, chapters or tracks on a disc. Tune to the presetted stations.

### 31) ZOOM button

Zoom into an image.

### NTSC / PAL button

In stop mode, select whether to output the video signal. TV shows "AUTO" which means output signal depends on DVD disc (either NTSC or PAL). TV shows "PAL" or "NTSC" which means output signal fixed to PAL or NTSC.

### 32) AUDIO button

Select one of the audio soundtracks programmed on a DVD or selects the audio output mode on a AUDIO CD.

### 33) BAND/REPEAT-DISC button

Switch between AM(MW) or FM.  
Repeat chapter or title of a DVD.  
Repeat single track or whole CD.

### 34) FM MODE/REPEAT A - B button

Set FM MODE to FM STEREO for FM stereo sound or to FM MONO for mono sound.  
Perform point-to-point repeat playback on a DVD or CD.



# PARTS AND FUNCTIONS

## Front and Top Panel

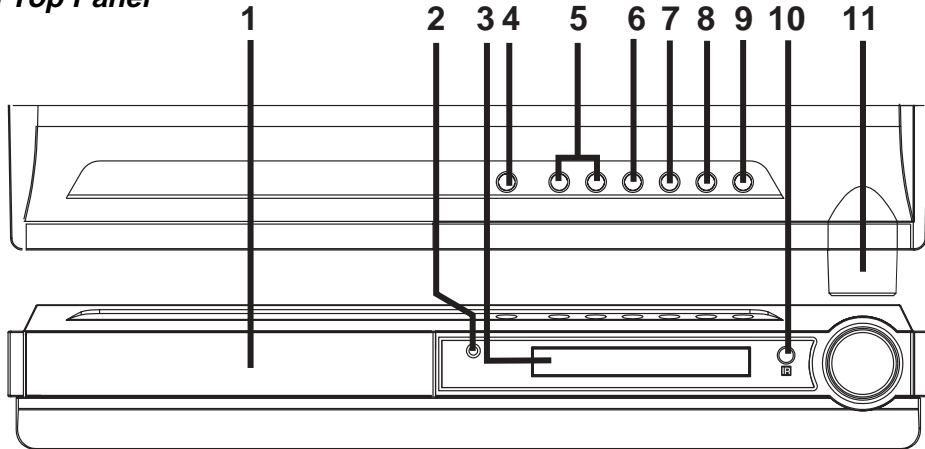

- 1) **Disc tray**  
Open or close tray by pushing OPEN/CLOSE button. Place a disc on the disc tray, label side up.
- 2) **STANDBY indicator**  
When the Unit is turned on by pressing the STANDBY/ON button. If you press the STANDBY  $\odot$ /ON button on the remote control, the Unit will turn off and go into standby mode. The light will continue to illuminate.
- 3) **Display window**  
Display system information.
- 4) **OPEN/CLOSE button**  
Use to open and close the disc tray.
- 5) **◀◀ SKIP ▶▶ buttons**  
Press SKIP ◀◀ button to go back to previous chapters/tracks.  
Press SKIP ▶▶ button to advance to chapters / tracks. Press and hold ◀◀ SKIP ▶▶ button to begin fast scan. Four speeds are available.  
Scan all available radio stations.
- 6) **▶ PLAY button**  
Press to start or resume playback
- 7) **■ STOP button**  
Stop playing a disc.
- 8) **FUNCTION button**  
Select the source.
- 9) **STANDBY/ON button**  
Turn the power on or off.
- 10) **Remote sensor**  
Receive the remote control unit signals.
- 11) **VOLUME controls**  
Change the loudness of the sound from the speakers connected to the Unit.

### Note:

Screen saver - If no button is pressed within 2 minutes, the function will active, If you want to return the normal screen, press any button.

## Rear Panel

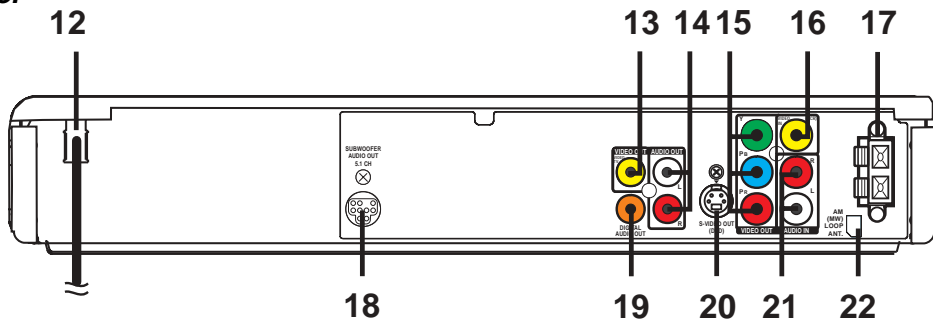

- 12) Power cord
- 13) VIDEO OUT jack
- 14) Left/Right AUDIO OUT jacks
- 15) COMPONENT VIDEO jacks (Y, PB/CB, PR/CR)
- 16) VIDEO IN (VCR) jack
- 17) FM ANTENNA jack
- 18) SUBWOOFER AUDIO OUT jack
- 19) DIGITAL AUDIO OUT jack
- 20) S-VIDEO OUT jack
- 21) AUDIO IN (R/L) jacks
- 22) AM(MW) LOOP ANTENNA terminal

# DISPLAY

## Front Panel Display

### MEMORY indicator

Displayed during programmed playback.

### ANGLE indicator

Appears when multiple camera angles are recorded in the section of the DVD that is currently playing.

### REPEAT 1 and A-B playback indicators

Displayed during repeat playback.

### DOLBY DIGITAL indicator

Displays while Dolby Digital sound processing is being performed or when the loaded disc contains Dolby Digital sound



### PRO LOGIC II indicator

When PRO LOGIC sound is selected in AV-IN mode, the light will illuminate.

### OPERATION indicator

Indicates the operation status of the disc and Unit.

### STEREO indicator

Tune into a station. "((ST))" will appear when an FM broadcast is in stereo.

## Display Information

The DVD displays the information shown below on the TV screen and on the Unit's DVD display depending on the operation status.

### Display Examples

	TV Screen	Unit Display	Remarks
If no disc is loaded when the Main Unit is switched on.	No Disc	NO DISC	"NO DISC" appears when the tray is closed and: 1)There is no disc in the tray. 2)The disc type is not playable in this Unit. 3)The disc is not loaded correctly (upside-down, etc.)
Tray open	▲	OPEN	
Tray closed	▲ Close		
Loading	⌚ Loading...	LOAD	
Stopped	Stop ■		The display changes to show other indicators (total time, etc.)
Playing	Play ▶		
Paused	Pause II		Freezes the image on the screen or pauses audio playback.
Fast forward	▶▶ x 2		The display changes to show other indicators (total time, etc.)
Fast reverse	◀◀ x 2		
Slow	◀/▶ x 1/2		Does not function for Audio CDs.
Repeat A - B	Rep A- Rep A-B	A-B	Repeat a specific section.
	⊘		The operation is not permitted by the DVD Unit or the disc.

## Region (Local) Number Error Indicator

If the region (local) number of the disc that you attempt to play differs from the region number of the Unit. "Invalid Region" appears on the TV screen. (The disc cannot be played).

# SETUP

## For better reception

### FM

Connect FM antenna (included) to the FM ANTENNA jacks.

### AM(MW)

Connect the loop antenna (included) to the AM(MW) LOOP ANTENNA terminals.

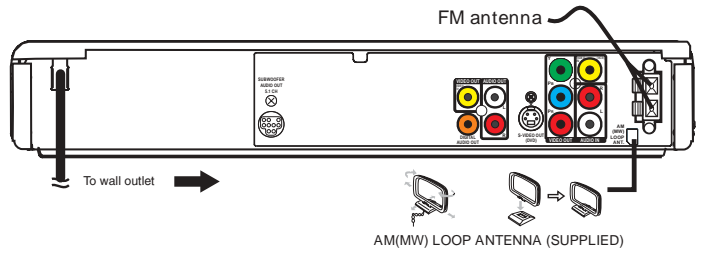

## A. Connecting your TV

The unit can be connected to your TV in several different ways, depending on the design of your TV.

or

### RCA Audio/Video cable

Use the Audio/Video cable (supplied). Connect the VIDEO OUT and left/right AUDIO OUT jacks on the unit to the VIDEO IN and left/right AUDIO IN jacks on your TV.

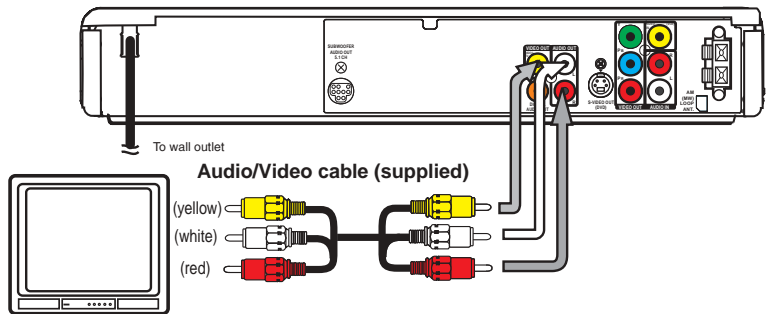

or

### S-Video cable

Use an S-Video cable (not supplied) and the Audio cable (not supplied).

1. Use an S-Video cable to connect the S-VIDEO (DVD) jack on your unit to the S-VIDEO IN jack on your TV.
2. Next, use the Audio cable to connect the left/right AUDIO OUT jacks on the unit to the left/right AUDIO IN jack on your TV.

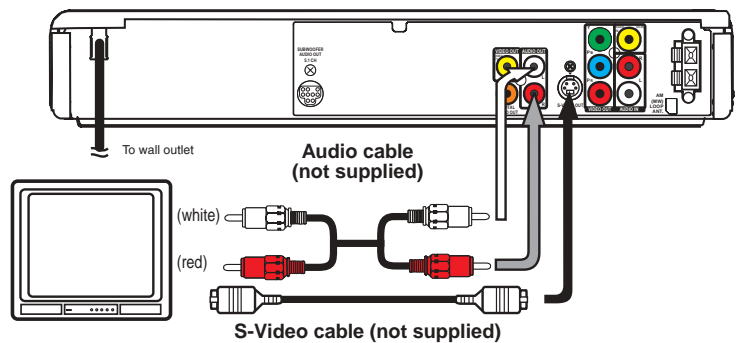

or

### 3 Phono/Scart cable

Use the 3 phono/Scart cable (not supplied). Connect the VIDEO OUT and left/right AUDIO OUT jacks on the unit and Scart to your TV.

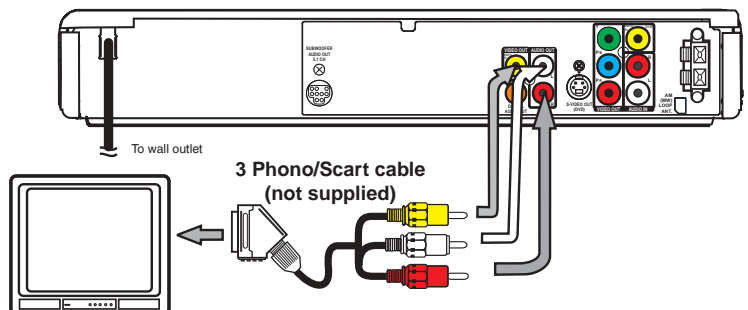

# SETUP

or

## Component video outputs (DVD)

Some TVs or monitors are equipped with component video inputs.

Using the Audio cable (not supplied), connect the left/right AUDIO OUT jacks on your Unit to the left/right AUDIO IN jacks on your TV and the Component video cable (not supplied), connect the **Green** plug Y VIDEO OUT jack on your Unit to Y VIDEO IN jack on your TV, the **Blue** plug Pb/Cb VIDEO OUT jack on your Unit to Pb/Cb VIDEO IN jack on your TV and the **Red** plug Pr/CR VIDEO OUT jack on your Unit to Pr/CR VIDEO IN jack on your TV to view the higher quality picture playback.

## Progressive outputs (DVD)

Some TVs or monitors are equipped with component video inputs that are capable of reproducing a progressively scanned video signal.

Using the Audio cable (not supplied), connect the left/right AUDIO OUT jacks on your Unit to the left/right AUDIO IN jacks on your TV and the Component video cable (not supplied), connect the **Green** plug Y VIDEO OUT jack on your Unit to Y VIDEO IN jack on your TV, the **Blue** plug Pb/Cb VIDEO OUT jack on your Unit to Pb/Cb VIDEO IN jack on your TV and the **Red** plug Pr/CR VIDEO OUT jack on your Unit to Pr/CR VIDEO IN jack on your TV to enjoy highest quality picture with less flicker.

Press the **SETUP** button and select Video Output to YUV (see page 28). Connect the component video cable to TV, press the **P. SCAN** button repeatedly on the remote control when DVD is stopped. "P. SCAN" display. You can select the output signal for better picture quality.

### Attention:

- When progressive output is activated, no video signal output from S-video and RCA (CVBS) video jacks.
- Make sure your TV supports progressive scan component video signal, press the **P. SCAN** button repeatedly until "CVBS" display for going back CVBS video signal.

### Notes :

- Connect the Unit to your TV directly. If you connect the Unit through a VCR, the playback picture will be distorted because DVD discs are copy protected.
- When you connect the Unit to other equipment, be sure to turn off the power and unplug all of the equipment from the wall outlet before making any connection.
- Refer to the instruction manual of the connected equipment as well.

## B. Connecting another source

### Analogue connection

Using the Audio cable (not supplied), connect the left/right AUDIO OUT jack on your Unit to the AUDIO IN jack.

### Digital connection

Using the Coaxial Digital Audio cable (not supplied), connect the DIGITAL AUDIO OUT on your Unit to the DIGITAL AUDIO IN jack on your another equipment.

### Listening to another audio equipment

1. Turn on the Unit.
2. Turn on your audio equipment and follow the instructions included with it to select the AUDIO IN or DIGITAL IN function.

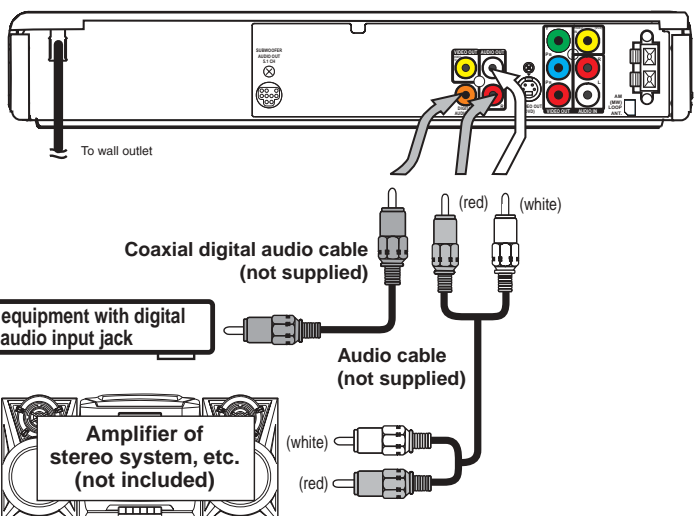
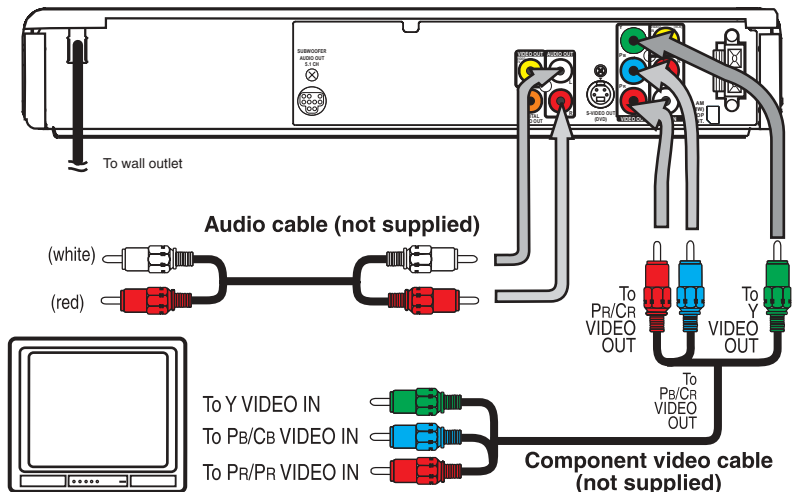

# SETUP

## C. Connecting a VCR

1. Using the supplied Audio/Video cable, connect the yellow plug from VIDEO OUT jack on your Unit to VIDEO IN jack on your TV, connect the left and right AUDIO OUT jacks on your Unit to AUDIO IN jacks on your TV. If you want the sound come from the speakers of the Main Unit, you need not to connect these left and right Audio cable from the Main Unit to your TV.
  2. Using the Video cable (not supplied), connect the VIDEO IN (VCR) jack on your Unit to VIDEO OUT jack on your VCR.
  3. Using the Audio cable (not supplied), connect the left/right AUDIO IN jacks on your Unit to the AUDIO OUT jacks on your VCR.
- An adaptor can be bought locally to connect the round RCA-style plugs to a scart socket. For the TV get a scart INPUT adaptor. For the VCR get a scart OUTPUT adaptor.

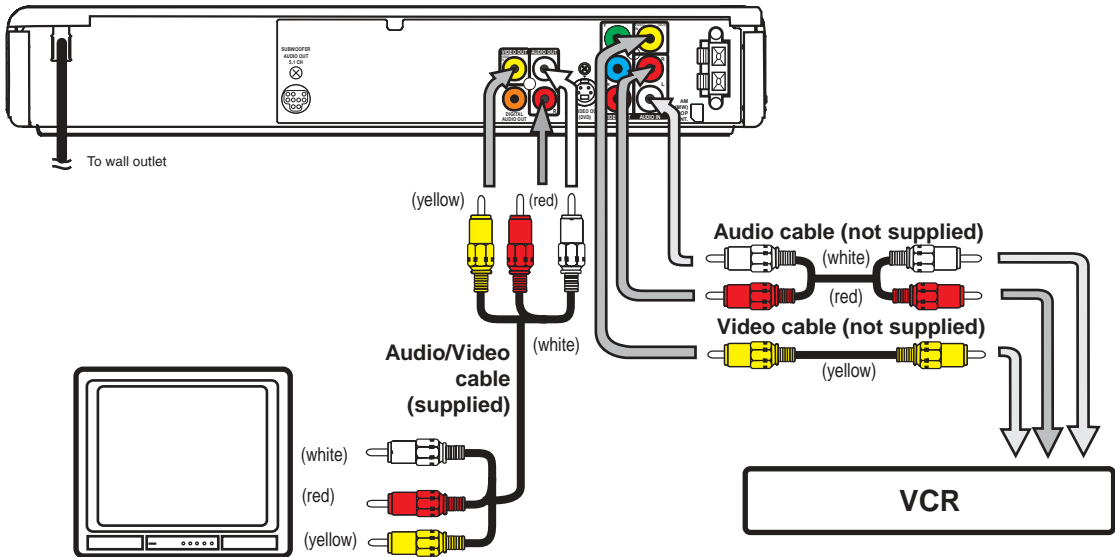

### Watching a DVD

1. Turn on the Unit, use the **FUNCTION** button on the remote control or the front panel to select "DVD".
2. Turn on your TV and follow the instructions included with it to select VIDEO function which correspond to the VIDEO IN jack you need connected with the Main Unit.

### Watching a Videotape

1. Turn on the Unit, use the **FUNCTION** button on the remote control or the front panel to select "AV\_IN".
2. Turn on your TV and follow the instructions included with it to select VIDEO function which corresponds to the VIDEO IN jack that is connected with the Main Unit.
3. Turn on the VCR and follow the instructions included with it to play the videotape.

### Notes:

- If you want sound from the Unit and sound from equipment connected to it (see next page) to come only from the speakers of the Unit, do not connect the left and right audio plugs from the Unit to your TV.
- Sound from the VCR or other external equipment will not be heard from the television if you connect the television with a scart to scart cable. This is because the scart connector on the DVD amplifier Unit only carries output from the DVD player part.
- If VCR Audio is mono, surround speakers sound level will be low or absent.

### To hear the sound from television programmes through the Unit

Sound from the television does not go to the speakers of the DVD amplifier Unit with the suggested connections. To hear sound from television programmes through the DVD amplifier's loudspeakers you need to use your video recorder as a television tuner. To do this follow these steps:

1. Connect up the VCR as above in "Connecting a VCR". If your television does not have the round (RCA-style) connectors you can get an RCA to scart input adapter.
2. Press the **FUNCTION** button on the DVD Amplifier Unit to get AV\_IN mode, shown on the front panel display.
3. On the television, select the AV or scart input channel for the DVD amplifier Unit.
4. On the VCR, select the television programme you want to watch.
5. On the DVD amplifier Unit select normal stereo or Pro Logic decoder modes according to your preference.
  - Please refer to the AV\_IN rows of the table on page 16 describing which speakers the sound will come out of.
  - When using the VCR as a television tuner, you cannot watch one programme while recording another.

# SETUP

## D. Connecting the speakers & subwoofer

The speaker cords have been color-coded to simplify connection. Just plug the **POSITIVE (+)** and **NEGATIVE (-)** ends of each speaker wire into the corresponding jacks on the rear of the Unit, matching the color tube on the end of the speaker wire to the color-coded connector.

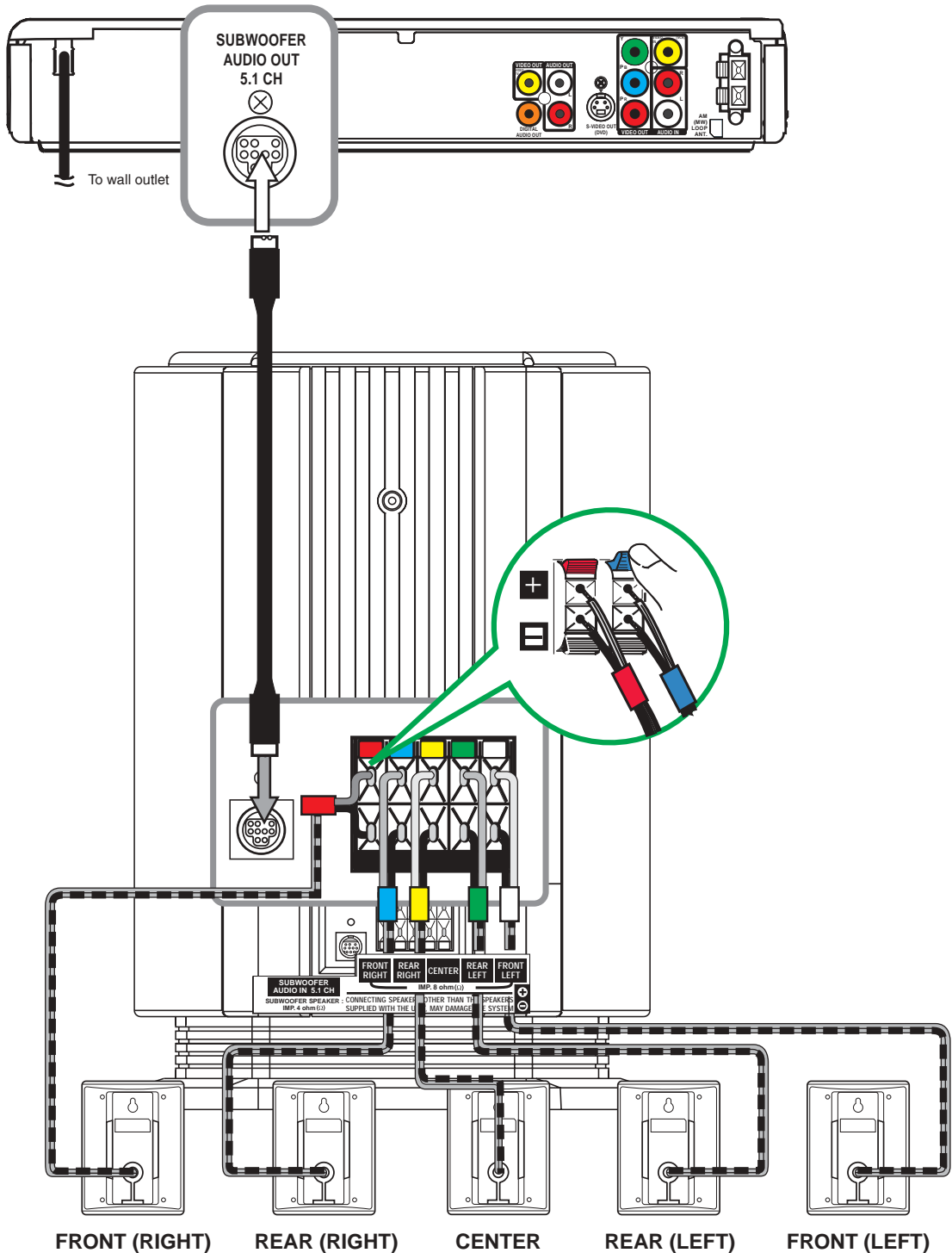

# SETUP

## E. Positioning the speakers and subwoofer

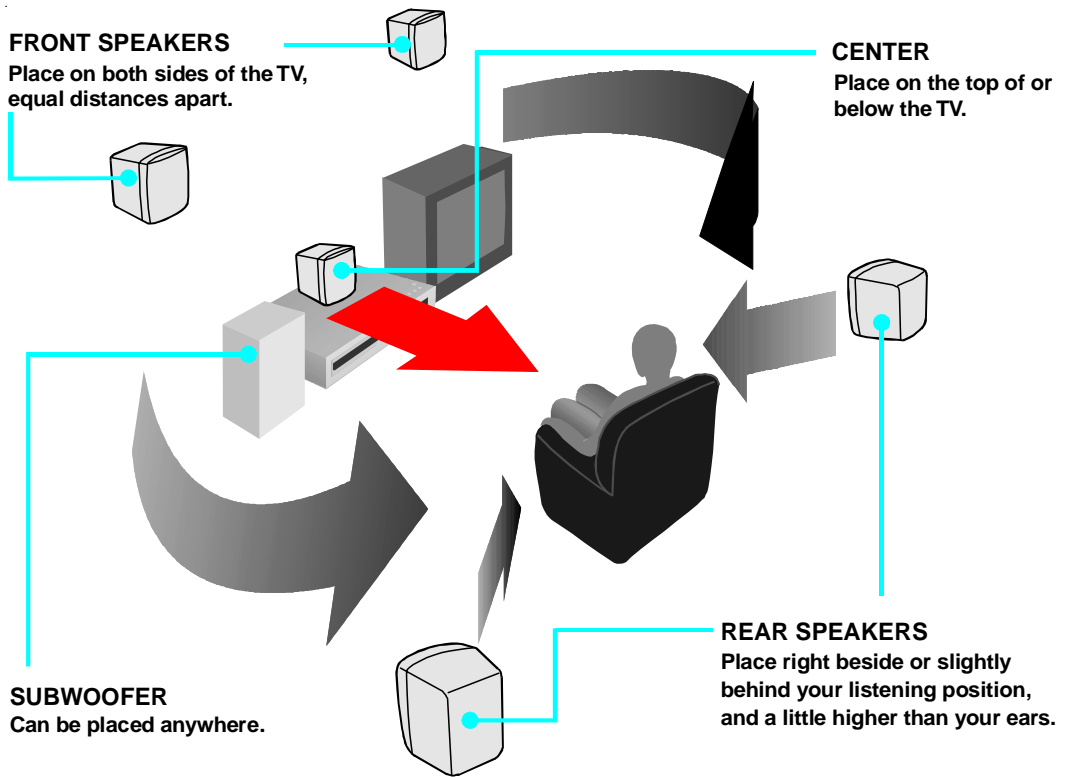

# SETUP

## ***Mounting rear surround speakers***

- 1) Mark the correct mounting position on the wall.
- 2) Insert a fixing screw(s) at the marked position on the wall.
- 3) Align the slot hole(s) of the speaker over the screw and pull the speaker downward until it is firmly hooked.

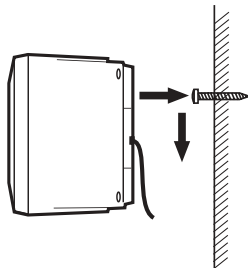

## **Need More Help?**

**DO NOT RETURN THIS TO THE STORE**

**Please call Customer Service at 1-800-252-6123  
or visit online help at <http://www.18002526123.com>**

## ***Turning on the Unit and TV***

- 1) Press the **STANDBY/ON** button to turn the Unit ON, or
- 2) Press the **STANDBY**  **/ON** button on the remote control or the **FUNCTION** button or the **▶ PLAY** button to turn on the Unit while the Unit is in standby mode.
- 3) Turn on the TV by pressing its **POWER** button.
- 4) Select the channel on your TV corresponding to the VIDEO IN jack that the Unit is connected to. See TV User guide for more information.
  - If you have connected the Unit successfully, the DVD logo (start-up picture) will appear on your TV screen.

### **Notes :**

- Whenever no disc or disc stop for 60 minutes, the system will be turned to POWER standby mode automatically.
- The LED of Standby will be turned on while the unit is at standby mode.



## ***Power cord connection***

- Make sure that all the components and speakers are connected correctly.
- **To prevent electrical shock, match wide blade of plug to wide slot, fully insert.**
- Be sure the AC power cord is disconnected and all functions are off before making connections.
- When you are not going to use the Unit for a long period of time, disconnect the power cord.



# ADJUSTING THE SOUND

## ***To adjust the surround sound balance while Dolby Digital and Pro Logic II decoding is in effect***

Use the remote control to make the following changes to speaker balance:

### **Front speaker (left)**

- Press the **SOUND** button repeatedly to display *LEFT 5*, then press the **▼** or **▲** **CURSOR** button to adjust the sound level. It will show on the display of the Unit.

### **Front speaker (right)**

- Press the **SOUND** button repeatedly to display *RIGHT 5*, then press the **▼** or **▲** **CURSOR** button to adjust the sound level. It will show on the display of the Unit.

### **Center speaker**

- Press the **SOUND** button repeatedly to display *CENT 10*, then press the **▼** or **▲** **CURSOR** button to adjust the sound level. It will show on the display of the Unit.

### **Rear speaker (left)**

- Press the **SOUND** button repeatedly to display *REAR L 10*, then press the **▼** or **▲** **CURSOR** button to adjust the sound level. It will show on the display of the Unit.

### **Rear speaker (right)**

- Press the **SOUND** button repeatedly to display *REAR R 10*, then press the **▼** or **▲** **CURSOR** button to adjust the sound level. It will show on the display of the Unit.

### **Subwoofer**

- Press the **SOUND** button repeatedly to display *SUB 10*, then press the **▼** or **▲** **CURSOR** button to adjust the sound level. It will show on the display of the Unit.

### **Note :**

- If you do not press any button within a few seconds, the display will return to normal.

## ***To adjust the sound quality***

Press the **SOUND** button repeatedly to select an equalization mode (**BASS** and **TREBLE**). Press the **▼** or **▲** **CURSOR** button to adjust the sound level.

**BASS** : the low range of sounds

**TREBLE** : the high range of sounds

Bass and treble control the sound from the front left and right speakers.

### **Dolby Digital**

Dolby Digital is a sound system developed by Dolby Laboratories Inc. that gives movie theatre ambience to audio output when the Unit is connected to a Dolby Digital 5.1 channel processor or amplifier. This Unit automatically recognizes DVDs that have been recorded with Dolby Digital. Not all Dolby Digital sources are recorded with 6 channels.

Some sources marked Dolby Digital may be recorded in Dolby Surround, a 2 channel system. Look for this logo on your DVD Unit.



**Dolby Pro Logic II** creates five full-bandwidth output channels from two-channel sources. This is done using an advanced, high-purity matrix surround decoder that extracts the spatial properties of the original recording without adding any new sounds or tonal colorations.



### **Movie Mode (MOVIE)**

The Movie mode in Pro Logic II is very similar to that of the original Pro Logic decoder. The main difference is that it has stereo surround channels and no surround filter, unlike Pro Logic which has a mono surround channel and a 7 kHz surround filter. Movie mode is the standard required for all A/V systems. When an autosound unit has a video screen, it is also considered an A/V system. It can be called simply "Pro Logic II".

### **Music Mode (MUSIC)**

The Music mode offers users some flexibility to control the end results to their own taste. Music mode should not be used with THX audio processing mode. Music mode is recommended as the standard mode for autosound music systems (without video), and is optional for A/V systems. It is recommended that Music mode be identified as the "Music" version of Pro Logic II, to distinguish it from the Movie mode.

# ADJUSTING THE SOUND

## Pro Logic Emulation Mode

The Pro Logic emulation mode offers users the same robust surround processing as original Pro Logic, in case the source content is not of optimum quality, or if there is a desire to hear the program more "as it used to be". When this mode is used, it is called Pro Logic, as before. There is no "Pro Logic I" mode. The Pro Logic emulation mode is optional. Dolby does not require PLII products to use the original Pro Logic decoding algorithm. However, if the DSP contains the original Pro Logic code, and if the product maker would like to use it, this is quite acceptable and even encouraged. A product must not offer both original Pro Logic and the Pro Logic emulation mode.

## Matrix Mode

The Matrix mode is the same as the Music mode except that the directional enhancement logic is turned off. It may be used to enhance mono signals by making them seem "larger". The Matrix mode may also find use in auto systems, where the fluctuations from poor FM stereo reception can otherwise cause disturbing surround signals from a logic decoder. The ultimate "cure" for poor FM stereo reception may be simply to force the audio to mono.

**DTS and DTS Digital Out** are trademarks of Digital Theater Systems, Inc.

This Unit does not decode DTS Digital Surround signal.

To enjoy DTS Digital Surround™ playback, an external 5.1 channel DTS Digital Surround™ decoder system must be connected to the DIGITAL AUDIO OUT jack of the Main Unit.

Manufactured under license from Dolby Laboratories.

'Dolby', 'Pro Logic II' and the double-D symbol are trademarks of Dolby Laboratories.

"DTS" and "DTS Digital Out" are trademarks of Digital Theater Systems, Inc.

## To select the listening channel

1. When the disc is stopped, you can press the **5.1/2.1 CH** button on the remote control to select different speakers output status shown on below table.
2. At AV IN function mode, you also can press the **PRO LOGIC II** button repeatedly on the remote control to select **PRO LOGIC II** (indicator on the front panel of display will illuminate).
3. You can active or off subwoofer output by setup menu.

### Notes:

- The wording "2.1 CH" will be corresponded to the audio/sound output from Front Left and Front Right speakers plus the Subwoofer.
- **5.1/2.1 CH** button is no response to JPG CD-ROM or JPG/MP3 CD-ROM. Please select 5.1/2.1 CH output before putting such CD-ROM.
- Dolby Digital 5.1 CH will not be activated on Pro Logic II.

The following table show which speakers are working in the various modes.

FUNCTION	DISCS	5.1 / 2.1 CH Button	L/R SPEAKER (SMALL/LARGE)	SUB-WOOFER ON/OFF	Dolby Pro Logic II Selection					
					EMU	MATRIX	MUSIC	MOVIE	BY PASS	
DVD MODE	DVD / CD	5.1 CH	SMALL	ON	5.1	5.1	5.1	5.1	5.1 or 2.1	
			LARGE	ON	5.1	5.1	5.1	5.1	5.1 or 2	
		---	OFF	5	5	5	5	5 or 2		
		2.1 CH	SMALL	ON	2.1	2.1	2.1	2.1	2.1	
			LARGE	ON	2	2	2	2	2	
		---	OFF	2	2	2	2	2		
	MP 3	5.1 CH	---	---	---	5.1	5.1	5.1	5.1	5.1
			---	ON	2.1	2.1	2.1	2.1	2.1	
		---	---	OFF	2	2	2	2	2	
		PCM DVD	5.1 CH	---	ON	5.1	5.1	5.1	5.1	5.1
				---	OFF	5	5	5	5	5
			2.1 CH	SMALL	ON	2.1	2.1	2.1	2.1	2.1
LARGE	ON	2		2	2	2	2			
---	OFF	2	2	2	2	2				
TUNER	---	---	---	---	2.1	2.1	2.1	2.1	2.1	
AV_IN	---	---	SMALL	ON	5.1	5.1	5.1	5.1	5.1	
			LARGE	ON	5.1	5.1	5.1	5.1	2.1	
			---	OFF	5	5	5	5	5	

Dolby Pro Logic II not applied on Tuner, MP3 and PCM DVD.



**5.1** - Represents FRONT LEFT/RIGHT, REAR LEFT/RIGHT, CENTER speakers and SUBWOOFER

**2.1** - Represents FRONT LEFT/RIGHT speakers and SUBWOOFER

**5** - Represents FRONT LEFT/RIGHT, REAR LEFT/RIGHT and CENTER speakers

**2** - Represents FRONT LEFT/RIGHT speakers

This owner's manual explains the basic instructions of this DVD Unit. Some DVD discs are produced in a manner that allows specific or limited operation during playback. As such, the DVD Unit may not respond to all operating commands. This is not a defect in the DVD Unit. Refer to the instruction notes of discs.

“” may appear on the TV screen during operation. A “” means that the desired operation is not permitted by the DVD Unit or the disc.

## *Playing a Disc*

1. Press the **STANDBY/ON** button on the front panel or press the **STANDBY** /ON button on the remote control to turn on the Unit while the Unit is in standby mode, press the **FUNCTION** button to select DVD mode.

See **CUSTOMIZING THE FUNCTION SETTINGS** (page 29 to 36) before proceeding to step 2.

2. Press the **▲ OPEN/CLOSE** button. The disc tray opens.

3. Place the disc on the disc tray with the label side up.

4. Press the **▲ OPEN/CLOSE** button. The disc tray closes.

It takes a short while for your Unit to load the disc. After loading, for some discs, the Unit will automatically start playback of the disc.

5. Press the **▶ PLAY** button.

### **Notes:**

- Use the **▲ OPEN/CLOSE** button on the front panel to open or close the disc tray. Do not push the disc tray or you may damage the Unit.
- Let the disc tray open completely before removing the disc. Press the **▲ OPEN/CLOSE** button to close the disc tray after you remove the disc.

## *Pausing playback (still mode)*

Press the **⏸ PAUSE** button. To resume normal playback, press the **▶ PLAY** button.

## *Stopping playback*

Press the **■ STOP** button at the location where you want to interrupt playback. To resume playback at the position where the disc was stopped, press the **▶ PLAY** button.

If you press the **■ STOP** button twice, the Unit's memory will be cleared and pressing the **▶ PLAY** button will reset the disc to the beginning.

## *To skip to a different track*

- Press the **⏮ PREV** button on the remote once to skip to the start of the previous track.
- Press the **⏭ NEXT** button on the remote to skip to the next track.
- For audio CD disc, use the number buttons (remote control only) to jump straight to that track number.

# PLAYING A DISC

## Fast Forward/Fast Reverse

1. Press the **TUNING ►►** or **◄◄ TUNING** button when a disc is playing.

- The disc begins fast scan at x2 speed.
- Four speeds are available. Each time **TUNING ►►** or **◄◄ TUNING** button is pressed, the speed of fast scan changes in the following sequence:

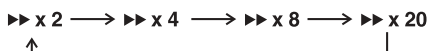

The speed of fast scan



2. Press the **► PLAY** button when you reach the desired point to resume playback at normal speed.

## Slow-motion play

1. Press the **SLOW ►** or **◄ SLOW** button in the play mode.

- Two speeds are available. Each time **SLOW ►** or **◄ SLOW** button is pressed, the speed of slow-motion playback changes in the following sequence: **► 1/2** → **► 1/4** or **◄ 1/2** → **◄ 1/4**



2. Press the **► PLAY** button to return to the normal playback speed.

## SKIP (Forward / Reverse)

While you are playing a disc, press the **►► NEXT** button of the remote to move to the beginning of the next chapter or track. Press the **◄◄ PREV** button of the remote to move to the previous chapter or track and automatically start playing it.

## Zooming into an image

While a disc is playing, press the **ZOOM/NTSC/PAL** button.

- While an image is zoomed, you can use **▲**, **▼**, **◄** and **►** button to shift the view and display the part you want.
- To return to the normal view, press the **ZOOM/NTSC/PAL** button until the “**Qoff**” symbol shows. The screen will return to normal.

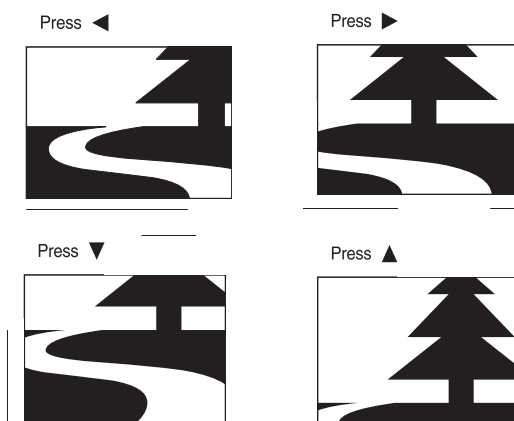

- When you reach the edge of the image, the display will not shift anymore in that direction.

## Angle selection

Some DVDs contain scenes which have been shot from a number of different angles. For these discs, the same scene can be viewed from each of these different angles.

1. While you are playing a DVD with different angles recorded, press the **ANGLE** button to view the number of the current angle.
2. Press the **ANGLE** button repeatedly to change the scene to the next angle in those recorded.
  - About two seconds later, playback continues from the new angle you selected.
  - If no button is pressed within 10 seconds, playback continues without changing the current angle.

### Sequence of angle shots

(Example)

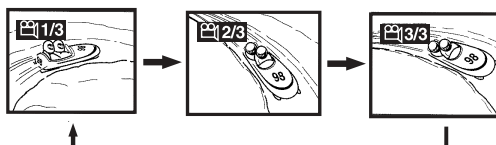
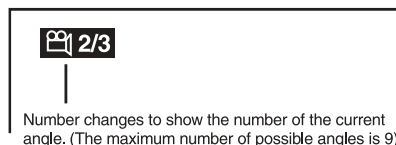

### Notes:

- This function can only be used for discs on which scenes shot from multiple angles have been recorded.
- If only one angle is recorded, “ 1/1 ” is displayed.

## Audio selection

On some discs, the sound is recorded in two or more formats. Follow the directions below to select the type of playback.

1. While a disc is playing, press the **AUDIO** button to show the current audio format number.
2. Press the **AUDIO** button repeatedly to select the desired audio format.

### Notes :

- If only one audio format is recorded, the number does not change.
- About two seconds later, playback continues in the new audio format.

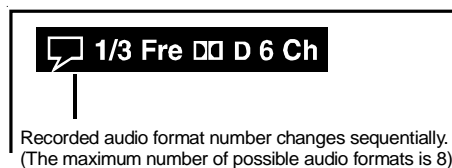

## Subtitle selection

1. While a DVD is playing, press the **SUBTITLE** button to display the current language setting, as shown in the example below.
2. Press the **SUBTITLE** button repeatedly to select the desired subtitle language.

1/3 Eng → 2/3 Spa → 3/3 Fre → Off

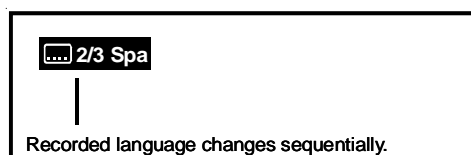

### Notes :

- If only one language is recorded, the language does not change.
- About two seconds later, playback continues with the new subtitle you selected.
- The number of languages recorded differs depending on the disc.
- If no button is pressed within a few seconds, playback continues without changing the current subtitle.
- This function can only be used for discs on which subtitles have been recorded in multiple languages.
- On some DVDs, subtitles are activated from the main menu of the DVD. Press the **MENU** button to activate the main menu.

# SPECIAL FUNCTIONS

## DISPLAY function

Using DISPLAY, you can check and change the current settings of the following items: ANGLE, AUDIO and SUBTITLE.

- While the disc is playing, press the **DISPLAY** button to display the screen shown below.
  - Elapsed time:** Elapsed time from the beginning of the chapter which is currently playing.
  - Remaining time:** Remaining time of the title which is currently playing.



- Press the **DISPLAY** button twice to display the screen shown as below.
- Press the **ANGLE**, **AUDIO** and **SUBTITLE** button to change the selected item.

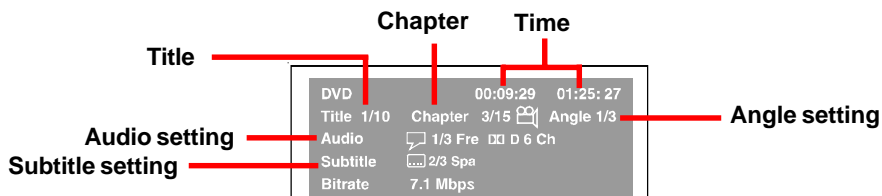

### Title skip

- The number of the title currently playing and total titles of disc.
- Press the **GOTO** button to set your desired title, then press the **ENTER** button to confirm.

### Chapter skip

- The number of the chapter currently playing and total chapters of the currently played title.
- Press the **GOTO** button to set your desired chapter, then press the **ENTER** button to confirm.

### Time skip

- Elapsed time from the beginning of the currently playing chapter and the remaining time from the beginning of the currently playing title.
- Press the **GOTO** button to set your desired point to start playback, then press the **ENTER** button to confirm.

### Angle setting

- The current angle is displayed. When a disc with only one angle is played back, "Angle 1/1" is displayed.
- Press the **ANGLE** button to select the desired angle.

### Audio setting

- The type of audio currently selected is displayed.
- Press the **AUDIO** button to select your desired type of audio.

### Subtitle setting

- The subtitle number and language currently selected is displayed. When a disc with only one subtitle is played back, "1/1 Eng" is displayed.
- Press the **SUBTITLE** button to select your desired language.

### GOTO function

This function allows you to skip directly to any part of the disc while a disc is playing.

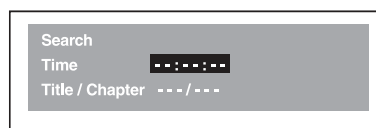

#### Note :

- After settings, press the **DISPLAY** button again to return to the normal screen.

## Locating a specific title

If a DVD disc contains title numbers, you can locate a specific title by directly selecting a title number.

1. In stop mode, press the **GOTO** button.
2. Press **▼**, **◀** or **▶** button to highlight a specific field and press the corresponding number button(s) for the title you want.
3. Press the **ENTER** button to confirm. The Unit will start playback about 3 seconds later.

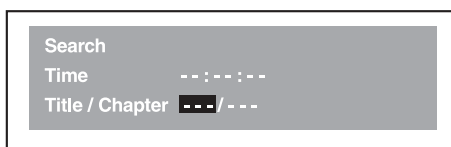

### Note :

- Pressing the **CLEAR** button resets the title number.

## Locating a specific title / chapter / track

If you know the title / chapter / track number you want to play, you can locate a specific title / chapter / track by directly selecting a title / chapter / track number.

1. Press the **GOTO** button to search your desired title / chapter / track.
2. Press **▼**, **◀** or **▶** button to highlight a title / chapter / track and press the corresponding number button(s) for the chapter you want.
3. Press the **ENTER** button to confirm. The Unit will start playback about 3 seconds later.

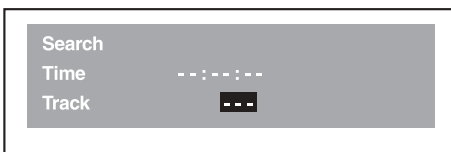
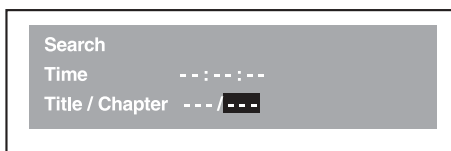

### Note :

- Pressing the **CLEAR** button resets the title / chapter / track number.

## Locating a specific time



You can move to a specific location by entering its corresponding time (hours, minutes, seconds)

1. Press the **GOTO** button.
2. Press **▲** or **▼** button to highlight time.

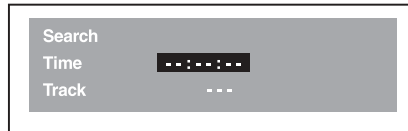
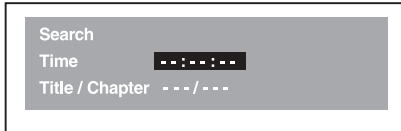

3. Press the corresponding number buttons for the setting point you want.
  - The first two numbers you entered represent hours.
  - The second two numbers you entered represent minutes.
  - The third two numbers you entered represent seconds.
4. Press the **ENTER** button to confirm. The Unit will start playback about 3 seconds later.

### Notes :

- Some discs may not respond to this process.
- Some scenes may not be located as precisely as you specified.
- This method for accessing specific locations is available only within the current title of the DVD disc.
- You can move through the menu by pressing the **▲** and **▼** buttons.
- Pressing the **CLEAR** button resets the time.

## Angle setting



1. Press the **DISPLAY** button twice. The **FUNCTION** menu is displayed on the screen and you can see how many angles are recorded on the disc.
2. Press the **ANGLE** button repeatedly to select your desired angle.
3. The Unit will change to your desired angle about 3 seconds later.

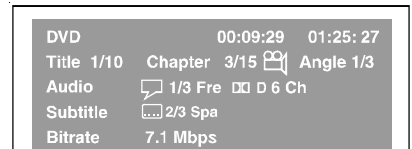

## Audio setting



1. Press the **DISPLAY** button twice. The **FUNCTION** menu is displayed on the screen and you can see how many audio formats are recorded on the disc.
2. Press the **AUDIO** button repeatedly to select your desired type of audio.
3. The Unit will change to your desired type audio about 3 seconds later.

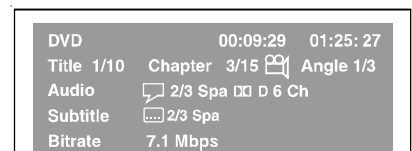

## Subtitle setting



1. Press the **DISPLAY** button twice. The **FUNCTION** menu is displayed on the screen and you can see how many subtitle formats are recorded on the disc.
2. Press the **SUBTITLE** button repeatedly to select your desired language.
3. The Unit will change to your desired language about 3 seconds later.

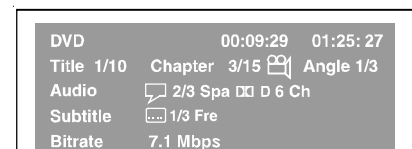



## Programmable memory

The two types of programmed playback provided by this Unit are title programmed playback and chapter programmed playback.

### Title / Chapter programmed playback

1. Press the **MEMORY** button while the disc is stopped.
2. Enter the title numbers in **--**. Use **◀** or **▶** button to move the highlight to chapter and enter the chapter numbers in **--**.

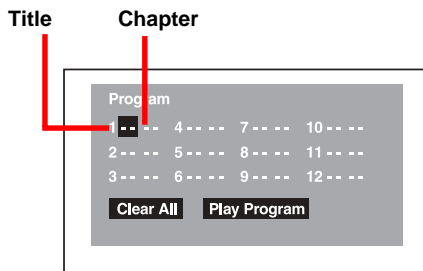

3. Use **◀**, **▶**, **▲** or **▼** button to move to the other field.
4. Repeat steps 2 to 3.
5. Press the **▶ PLAY** button to start the programmed playback.

#### Notes :

- If you press the **■ STOP** button twice at programmed playback mode, the programmed playback function will be cancelled.
- If you press the **CLEAR** button while you are entering a title or chapter, the currently entered numbers will be erased and you can reset the numbers again.

## Programmable memory

### Track programmed playback

1. Press the **MEMORY** button while the disc is stopped.
2. Enter the track numbers in **---**.

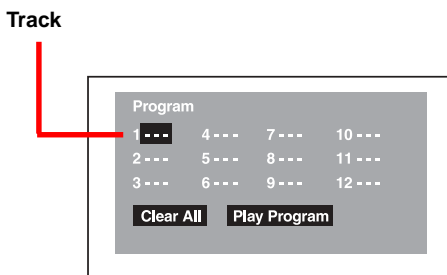

3. Use **◀**, **▶**, **▲** or **▼** button to other field.
4. Repeat steps 2 to 3.
5. Press the **▶ PLAY** button to start the programmed playback.

#### Note :

- If you press the **CLEAR** button while you are entering a track, the currently entered numbers are erased and you can reset the numbers again.

You can play a specific title or chapter repeatedly.  
(Title repeat, chapter repeat, A-B repeat)

## Repeating a title

You can play the same title repeatedly.

1. While the disc is playing, press the **REPEAT DISC** button until the “” indicator displays on the screen. The current title is played repeatedly.

Repeat Title

## Repeating a chapter

You can play the same chapter repeatedly.

2. While the disc is playing, press the **REPEAT DISC** button until the “” indicator displays on the screen. The current chapter is played repeatedly.

Repeat Chapter

## To resume normal playback

3. While the disc is playing, press the **REPEAT DISC** button until the “” indicator displays on the screen.

Off

You can play a single track and whole disc repeatedly.

## Repeating a single track

You can play the same track repeatedly.

1. While the disc is playing, press the **REPEAT DISC** button until the “Repeat Single” indicator displays on the screen. The current track is played repeatedly.

Repeat Single

## Repeating a whole disc

2. While the disc is playing, press the **REPEAT DISC** button until the “Repeat All” indicator displays on the screen. The whole disc is played repeatedly.

Repeat All

## To resume normal playback

3. Press the **REPEAT DISC** button until the “Off” indicator displays on the screen.

Off

## Repeating a specific section

You can play a specific section repeatedly.

1. While the disc is playing, press the **REPEAT A-B** button at the beginning of the section (Rep A -) is displayed you want to play repeatedly.
2. Press the **REPEAT A-B** button again at the end of the section (Rep A - B) is displayed.
3. The Unit will immediately begin replaying your selection.

Rep A -

Rep A - B

## To resume normal playback

4. While the disc is playing, press the **REPEAT A-B** button until the “Off” indicator displays on the screen.

Off

# PLAYING MP3 AND PICTURE FILE DISC

This Unit will play MP3 and Picture files recorded on CD-R disc.

## Playing a MP3 file disc

1. Press the **▶ OPEN /CLOSE** button, the disc tray opens.
2. Insert a MP3 file disc on the disc tray with the label side up.
3. Press the **▶ OPEN/CLOSE** button, the disc tray closes.
4. The Unit will take a short while to load the disc and automatically begin playback.

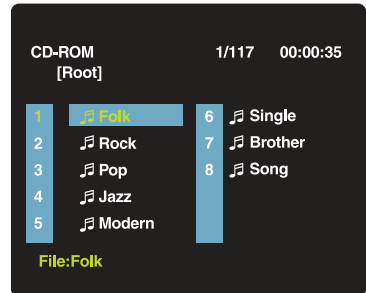

## To pause playback

- Press the **⏸ PAUSE** button. To resume playback again, press the **▶ PLAY** button.

## To stop playback

- Press the **■ STOP** button.

## To skip to the next or previous file

- Press the **▶▶ NEXT** button on the remote control briefly while playing, to skip ahead to the beginning of the next file. Each time you press the button consecutively, the beginning of the next file is located and played back.
- Press the **◀◀ PREV** button on the remote control briefly while playing, to skip back to the beginning of the previous file. Each time you press the button consecutively, the beginning of the previous files is located and played back.
- You also can press the **GOTO** button, set the track number you want and then press the **ENTER** button.

## Note:

- You can not play in Fast reverse or Fast forward during MP3 playback.

## On-screen display

Turn on your TV to view the on-screen display of MP3 files.

- Press the **▲, ▼, ◀ or ▶ CURSOR** button on the remote control to select the file you want to listen to, then press **ENTER** button and this selected file is located and played back.

## Notes:

The ability of this Unit to read MP3 discs is dependent on the following:

- The Bit Rate must be within 64 - 256 kbps.
- The total number of files on the disc should not exceed 254.
- The maximum number of directories should not exceed 32.
- The maximum depth level of directories should not exceed 4.
- File names should be named using 12 or fewer letters and/or numbers, and must incorporate the "MP3" file extension. EXAMPLE: \*\*\*\*\*.MP3 where each \* is a letter or number.
- Use only letters and / or numbers in file names. If you use special characters, the file and/or folder names may not be displayed correctly on the on-screen display.
- When recording on CD-R discs, use 74-minute (650MB) discs.
- The CD-R disc should be "finalized" in computer by "single session format".
- See your CD/MP3 creation software for details.

# PLAYING MP3 AND PICTURE FILE DISC

## Playing a Picture file disc

1. Press the **▲OPEN/CLOSE** button, the disc tray opens.
2. Insert a Picture CD on the disc tray with the label side up.
3. Press the **▲OPEN/CLOSE** button, the disc tray closes.
4. The unit will take a short while to load the disc.
5. Press the **▶PLAY** button. The next picture will automatically display after 6 seconds.

### Full-Screen Review

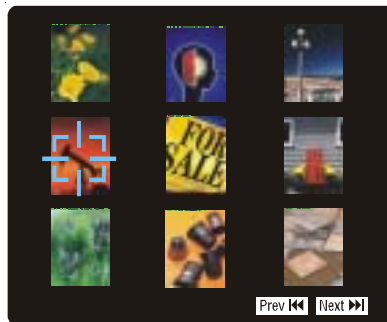

### Thumbnail Review

#### Notes:

- If you press the **MENU** button on the remote control in full-screen review, the Unit will display a menu of 9 thumbnail images.
- Use the **cursor** to highlight the **◀◀PREV** or **▶▶NEXT** in thumbnail screen and then press **ENTER** to review other images. If you want to review one image in full-screen, you can use the **CURSOR** **◀**, **▶**, **▲** or **▼** buttons to highlight the image and then press the **ENTER** button to confirm. The image you selected will show on TV in Full-Screen and automatically display one by one again in about 6 seconds intervals.
- You can press the **PAUSE** button to interrupt playback, and press the **▶PLAY** button to resume playback.
- You also can use **GOTO** function or use the numbered buttons to enter the number to quickly select any image.
- You can press the **ZOOM** button to enlarge the picture in 3 levels.
- Press the **ANGLE** button on the remote control to rotate the picture orientation by 90°.

## Playing a MP3/Picture file disc

1. Press the **▲OPEN/CLOSE** button, the disc tray opens.
2. Insert a MP3 files/Picture CD on the disc tray with the label side up.
3. Press the **▲OPEN/CLOSE** button, the disc tray closes.
4. The unit will take a short while to load the disc.
5. Use **◀**, **▶**, **▲** or **▼** button to select MP3 or Picture CD, then press the **ENTER** button.

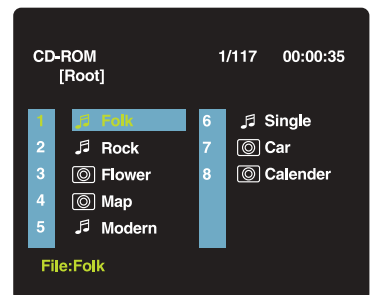

#### Notes:

- The **SETUP** button does not work during MP3 or Picture Disc playback or stop.

# RADIO OPERATION

## ***Tuning into a station manually***

1. Press the **FUNCTION** button until the frequency band appears on the display.
2. Press the **BAND** button on the remote or **STOP** button on the front panel to select the desired band.
3. Press the **◀ TUNING ▶** button to tune in the desired station.



## ***FM Stereo***

- Press the **FM MODE** button on the remote until "STEREO" appears on the display.



## ***Weak FM stations***

- Press the **FM MODE** button on the remote until the "MONO" word appears on the display. Background noise will be reduced but the signal reproduced will be mono. To restore stereo reception, press the **FM MODE** button on the remote to select STEREO.



### **Note:**

- The left / right front speakers and subwoofer are activated only.

## ***To search for a station automatically***

- Hold down the **◀ TUNING ▶** buttons on the remote, and a station is searched for automatically. After tuning in a station, the search stops.
- The search may not stop at a station with a very weak signal.

## ***Presetting stations***

You can tune into a stored station directly by entering the preset number.

20 stations on FM band can be preset.

20 stations on AM(MW) band can be preset.

1. Press the **FUNCTION** button until the frequency band appears on the display.
2. Press the **BAND** button on the remote to select the desired band.
3. Use the **◀ TUNING ▶** button to find your desired station.
4. Press the **MEMORY** button on the remote.
5. Press the **▶ I NEXT** or **PREV I ◀** button to select the preset number and press the **MEMORY** button on the remote to store the station.
6. Repeat steps 2-5 to store other stations.

## ***Tuning into a preset station***

1. Press the **FUNCTION** button on the front panel until the frequency band appears on the display.
2. Press the **BAND** button on the remote to select the desired band.
- Press the **▶ PLAY** button and **▶ I NEXT** or **PREV I ◀** button to select the presetted station or use the numbered buttons to enter the number to select the presetted station.

**Example:** To select preset number 15, press the +10 and 5 buttons.

To select preset number 10, press the +10 and 0 buttons.

# CUSTOMIZING THE FUNCTION SETTINGS

## **LANGUAGE setting**

1. Press the **FUNCTION** button until DVD appears on the display.
2. Press the **STOP** button so that no disc is playing.
3. Press the **SETUP** button.
4. Use ◀ or ▶ button to select the Language, then press the **ENTER** button.
5. Use ▲ or ▼ button to English, then press the **ENTER** button. The screen will change to English Wordings immediately.
6. To exit the FUNCTION SETUP MENU and return to the normal screen, press the **RETURN** button.

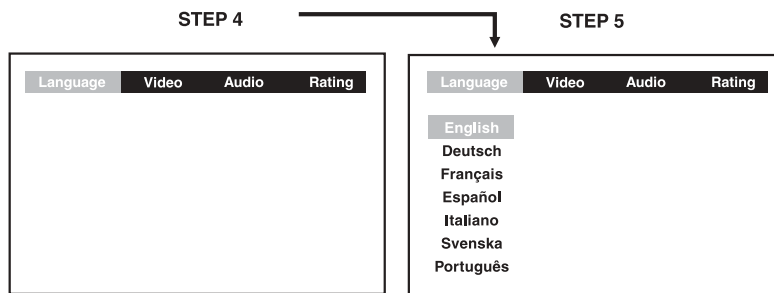

## **VIDEO setting**

### **TV Shape**

1. Press the **SETUP** button.
2. Use ◀ or ▶ button to select Video, then press the **ENTER** button.
3. Use ▲ or ▼ button to select TV Shape, then press the **ENTER** button.
4. Use ▲ or ▼ button to shift and select the TV type, then press the **ENTER** button.
5. To exit the FUNCTION SETUP MENU and return to the normal screen, press the **RETURN** button.

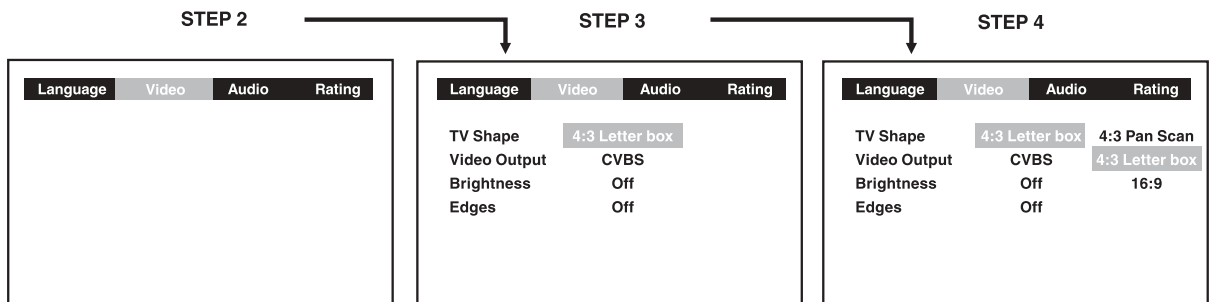

# CUSTOMIZING THE FUNCTION SETTINGS

Cut off when a wide-screen video image is played.

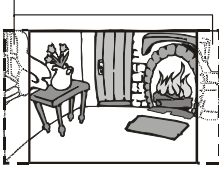

## 4:3 Pan Scan

- When wide-screen video material is played, this mode clips the right and left sides of the image so that it can be viewed on a conventional TV screen.
- Some wide-screen DVDs that do not permit Pan Scan mode playback are automatically played in letterbox mode (black bands top and bottom).



## 4:3 Letter Box

- When wide-screen video material is played in this mode on a conventional TV screen, black bands appear at the top and bottom of the screen.



## 16:9 Wide-screen

- This is the correct mode for playing wide-screen videos on a wide-screen TV.
- You must also set the screen mode on your wide-screen TV to "FULL".

The actual appearance of the image depends on the screen mode setting of your wide-screen TV.

### Notes :

- The displayable picture size is preset on the DVD disc. Therefore the playback picture of some DVD discs may not conform to the picture size you select.
- When you play DVD discs recorded in the 4:3 picture size only, the playback picture always appears in the 4:3 picture size regardless of the TV shape setting.
- If you select 16:9 wide-screen mode and you own a 4:3 TV set, the DVD playback picture will be horizontally distorted during playback. Images will appear to be horizontally compressed. Always be sure that your TV shape conforms to the actual TV in use.

## Video Output

1. Press the **SETUP** button.
2. Use ◀ or ▶ button to select Video, then press the **ENTER** button.
3. Use ▲ or ▼ button to select Video Output, then press the **ENTER** button.
4. Use ▲ or ▼ button to shift and select the signal, then press the **ENTER** button.
5. To exit the FUNCTION SETUP MENU and return to the normal screen, press the **RETURN** button.

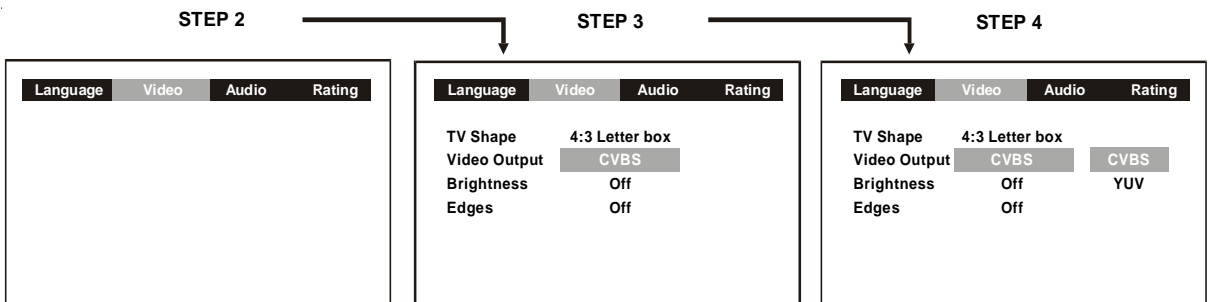

**CVBS** : Corresponding to your TV which has a Video or S-Video input.

**YUV** : Corresponding to your TV which has a YUV input. S-Video may not have video if YUV selected instead of CVBS.

### Attention :

Always set Video Output in CVBS, otherwise, the picture on the TV may be distorted. If this occurs, and you cannot see the screen, press the P.SCAN button repeatedly until the "CVBS" display. Display may fail to show "CVBS" in case there is no disc or tray opened.

# CUSTOMIZING THE FUNCTION SETTINGS

## Brightness

1. Press the **SETUP** button.
2. Use ◀ or ▶ button to select Video, then press the **ENTER** button.
3. Use ▲ or ▼ button to select Brightness, and then press the **ENTER** button.
4. Use ▲ or ▼ button to shift and select the Off/On, then press the **ENTER** button.
5. If you want to exit the SETUP MENU and return to the normal screen, press the **RETURN** button.

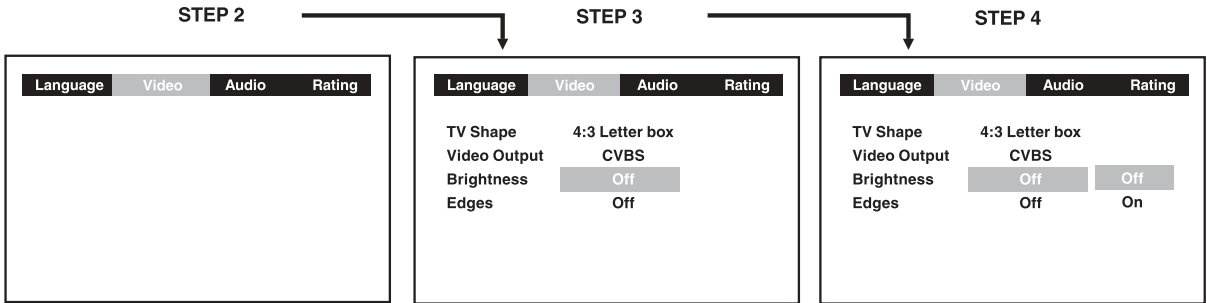

**On** : Picture will be brighter to clarify details.

**Off** : Picture will have deepened colors.

### Note:

- Actual effect on pictures will vary depending on the TV.

## Edges

1. Press the **SETUP** button.
2. Use ◀ or ▶ button to select Video, then press the **ENTER** button.
3. Use ▲ or ▼ button to select Edges, and then press the **ENTER** button.
4. Use ▲ or ▼ button to shift and select the Sharpen / Soften / Off, then press the **ENTER** button.
5. If you want to exit the SETUP MENU and return to the normal screen, press the **RETURN** button.

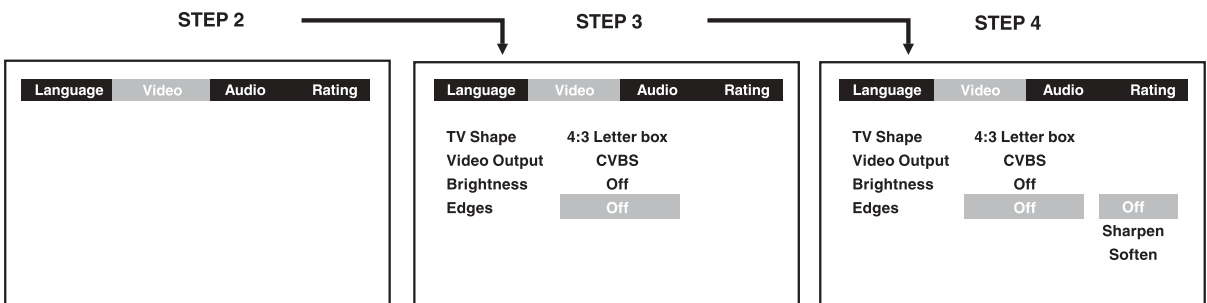

**Sharpen** : Fine detail will be easier to see.

**Soften** : Soft-focus effect.

**Off** : Picture will be returned to normal.



# CUSTOMIZING THE FUNCTION SETTINGS

## AUDIO setting

### Digital Out

1. Press the **SETUP** button.
2. Use ◀ or ▶ button to select Audio, press the **ENTER** button.
3. Use ▲ or ▼ button to select Digital Out, and then press the **ENTER** button repeatedly to select Digital Out type.
4. To exit the FUNCTION SETUP MENU and return to the normal screen, press the **RETURN** button.

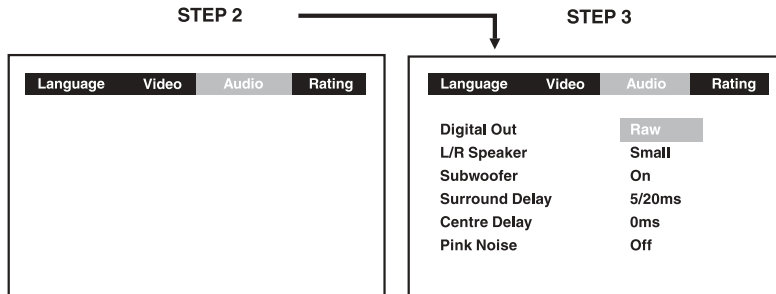

**Raw** : Does not have a Dolby Digital Decode.

**PCM** : Do have a Dolby Digital Decode.

### L/R Speaker

1. Press the **SETUP** button.
2. Use ◀ or ▶ button to select the Audio, press the **ENTER** button.
3. Use ▲ or ▼ button to L/R Speaker, and then press the **ENTER** button.
4. Use ▲ or ▼ button to select the desired setting, and then press the **ENTER** button.
5. To exit the FUNCTION SETUP MENU and return to the normal screen, press the **RETURN** button.

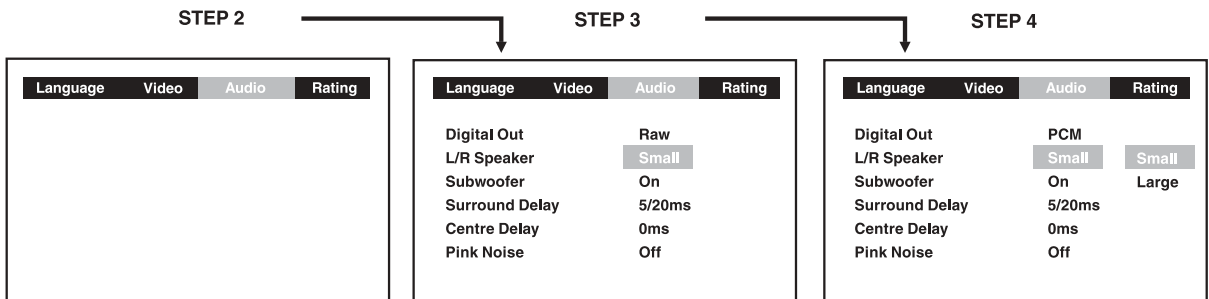

### L/R Speaker

**Small** : Small size of Speaker.

**Large** : Large size of Speaker (speaker diameter normally larger than 4 inch or 10 cm)

### Note :

- You can adjust the channel balance on your Unit. Please see "ADJUSTING THE SOUND" on page 17.

# CUSTOMIZING THE FUNCTION SETTINGS

## Subwoofer

1. Press the **SETUP** button.
2. Use ◀ or ▶ button to select the Audio, press the **ENTER** button.
3. Use ▲ or ▼ button to Subwoofer, and then press the **ENTER** button.
4. Use ▲ or ▼ button to select the desired setting, and then press the **ENTER** button.
5. To exit the FUNCTION SETUP MENU and return to the normal screen, press the **RETURN** button.

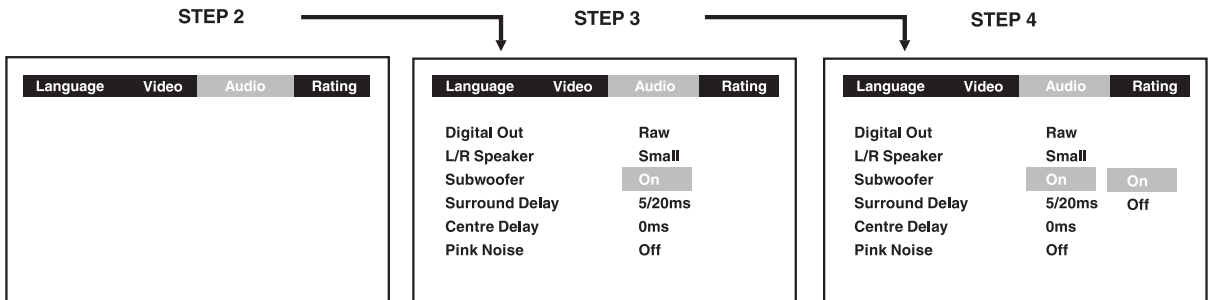

## Subwoofer

"On" should be selected if your subwoofer is connected.

If "Off" is selected, no sound will be emitted by subwoofer.

### Note :

- You can adjust the channel balance on your Unit. Please see "ADJUSTING THE SOUND" on page 17.

## Surround Delay

1. Press the **SETUP** button.
2. Use ◀ or ▶ button to select the Audio, press the **ENTER** button.
3. Use ▲ or ▼ button to Surround Delay, then repeatedly press the **ENTER** button to select the desired Surround Delay type. 0/15ms, 5/20ms, 10/25ms or 15/30ms appears.
4. To exit the FUNCTION SETUP MENU and return to the normal screen, press the **RETURN** button.

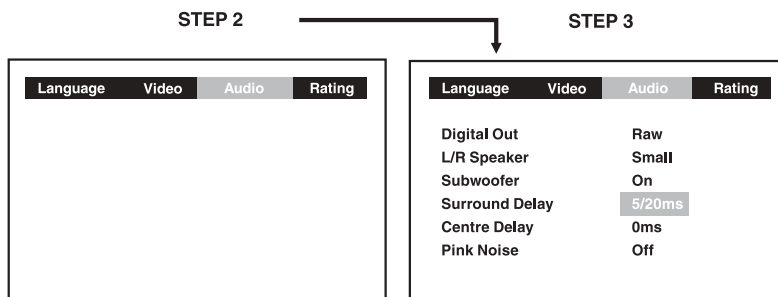

### Notes:

- The first number represents the Dolby Digital and the second number represents the Pro Logic.
- The delay adjustment depends on the location of your surround speakers and the front speakers. If the location of the surround speakers is closer than the front speakers, the delay adjustment can compensate the distance difference.

# CUSTOMIZING THE FUNCTION SETTINGS

## Center Delay

1. Press the **SETUP** button.
2. Use ◀ or ▶ button to select the Audio, press the **ENTER** button.
3. Use ▲ or ▼ button to Center delay, then repeatedly press the **ENTER** button to select the desired Center Delay type. 0ms, 1ms, 2ms, 3ms, 4ms or 5ms appears.
4. To exit the FUNCTION SETUP MENU and return to the normal screen, press the **RETURN** button.

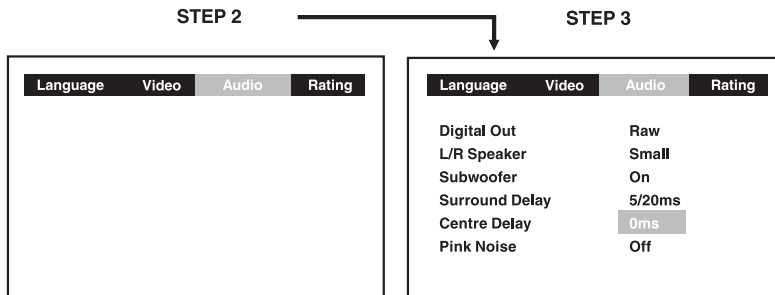

### Note:

- This delay adjustment depends on the location of your center speaker. If the distance between the center speaker and the listener is less than the distance between the front right and left speaker and the listener, this delay adjustment is balanced.

## Pink noise

1. Press the **SETUP** button.
2. Use ◀ or ▶ button to select the Audio, press the **ENTER** button.
3. Use ▲ or ▼ button to Pink noise, and then press the **ENTER** button.
4. Use ▲ or ▼ button to select the desired setting, and then press the **ENTER** button.
5. To exit the FUNCTION SETUP MENU and return to the normal screen, press the **RETURN** button.

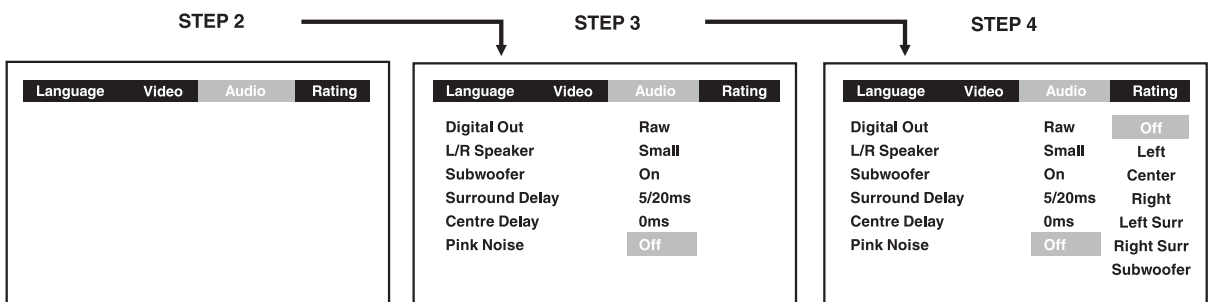

### Pink noise

**Off** : Pink noise test mode should always be switched off, unless you are testing your speakers.

**Left** : Pink noise comes out from front left speaker for testing.

**Center** : Pink noise comes out from center speaker for testing.

**Right** : Pink noise comes out from front right speaker for testing.

**Left sur** : Pink noise comes out from rear surround left speaker for testing.

**Right sur** : Pink noise comes out from rear surround right speaker for testing.

**Subwoofer** : Pink noise comes out from subwoofer for testing.

### Note :

- When using the pink noise generator to test your speakers, you can press the **SOUND** button on the remote control to adjust the channel balance. Please "Adjusting the Sound" on page 17.

(continued on next page)

# CUSTOMIZING THE FUNCTION SETTINGS

## RATING setting

### Password/Parental lock

DVD discs equipped with the password function are rated according to their content. The contents allowed by a parental lock level and the way a DVD disc can be controlled may vary from disc to disc.

For example, if the disc allowed, you could edit out violent scenes unsuitable for children and replace them with more suitable scenes, or you could lock out playback of the disc altogether.

1. Press the **SETUP** button.
2. Use ◀ or ▶ button to select Rating, press the **ENTER** button.
3. Use ▲ or ▼ button to select Parental lock and then press the **ENTER** button repeatedly to set the parental lock level.
4. Use ▲ or ▼ button to shift and select Password, enter your 4-digit security code and then press the **ENTER** button.

**If you make a mistake before pressing the ENTER button, press the CLEAR button and enter your 4-digit security code again.**

**You cannot play DVD discs rated higher than the level you selected unless you cancel the parental lock function.**

The parental lock level is equivalent to the following ratings.

Level 1 : Kid Safe	Level 5 : PG_R
Level 2 : G	Level 6 : R
Level 3 : PG	Level 7 : NC_17
Level 4 : PG_13	Level 8 : Adult

5. To exit the FUNCTION SETUP MENU and return to the normal screen, press the **RETURN** button.



Indicates Parental lock is NOT active.



The Parental lock is active.

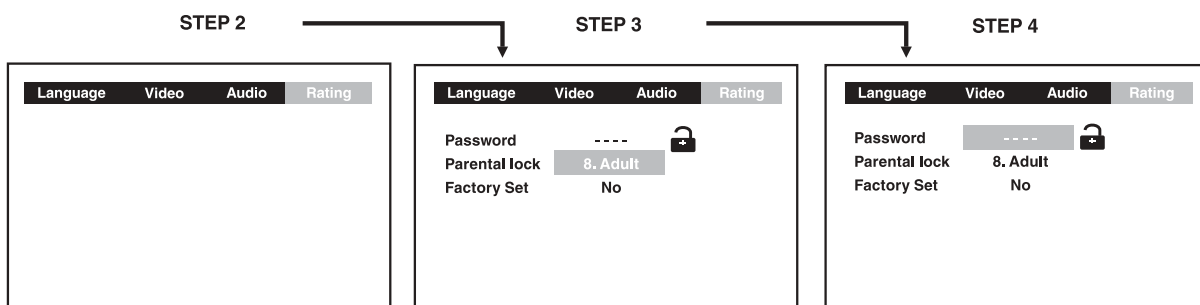

**If you forget the password, you can erase your current password by pressing number button 8 on the remote four times, then press the ENTER button to confirm the setting.**

**PASSWORD : 8 8 8 8**

# CUSTOMIZING THE FUNCTION SETTINGS

## Factory Set

If you want to return the initial language setting to the factory default, do the following:

1. Press the **SETUP** button.
2. Use ◀ or ▶ button to select the Rating, then press the **ENTER** button.
3. Use ▲ or ▼ button to shift and select the Factory Set, then press the **ENTER** button.
4. Use ▲ or ▼ button to shift and select Yes, then press the **ENTER** button.
5. To exit the FUNCTION SETUP MENU and return to the normal screen, press the **RETURN** button.

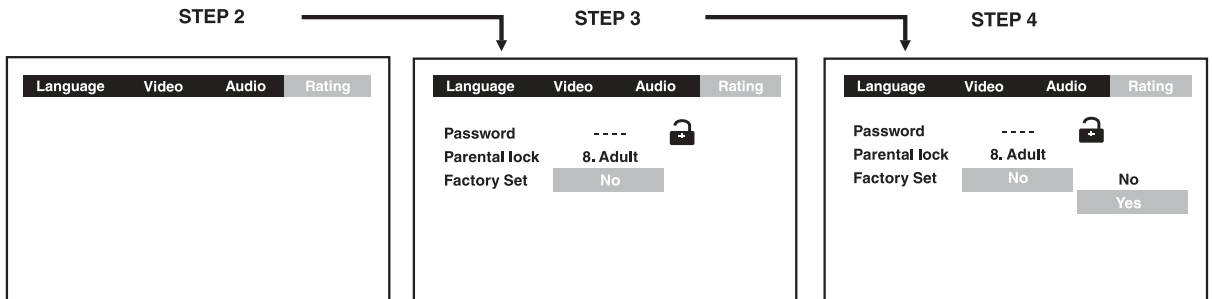

### Note:

When you reset the Unit to the factory default, the Unit will take 3-5 seconds to reset.

# LANGUAGE CODE LIST FOR DISC LANGUAGE

Code	Language Name	Code	Language Name	Code	Language Name	Code	Language Name
AA	Afar	FY	Frisian	MG	Malagasy	SL	Slovenian
AB	Abkhazian	GA	Irish	MI	Maori	SM	Samoa
AF	Afrikaans	GB	Scots Gaelic	MK	Macedonian	SN	Shona
AM	Ameharic	GL	Galician	ML	Malayalam	SO	Somali
AR	Arabic	GN	Guarani	MN	Mongolian	SQ	Albanian
AS	Assamese	GU	Gujarati	MO	Moldavian	SR	Serbian
AY	Aymara	HA	Hausa	MR	Marathi	SS	Siswat
AZ	Azerbaijani	HI	Hindi	MS	Malay	ST	Sesotho
BA	Bashkir	HR	Croatian	MT	Maltese	SU	Sundanese
BE	Byelorussian	HU	Hungarian	MY	Burmese	SV	Swedish
BG	Bulgarian	HY	Armenian	NA	Nauru	SW	Swahili
BH	Bihari	IA	Interlingua	NE	Nepali	TA	Tamil
BI	Bislama	IE	Interlingue	NL	Dutch	TE	Telugu
BN	Bengali	IK	Inupiak	NO	Norwegian	TG	Tajik
	Bangla	IN	Indonesian	OC	Occitan	TH	Thai
BO	Tibetan	IS	Icelandic	OM	(Afan) Oromo	TI	Tigrinya
BR	Breton	IT	Italian	OR	Oriya	TK	Turkmen
CA	Catalan	IW	Hebrew	PA	Panjabi	TL	Tagalog
CO	Corsican	JA	Japanese	PL	Polish	TN	Setswana
CS	Czech	JI	Yiddish	PS	Pashto, Pushto	TO	Tonga
CY	Welsh	JW	Javanese	PT	Portuguese	TR	Turish
DA	Danish	KA	Georgian	QU	Quechua	TS	Tsonga
DE	German	KK	Kazakh	RM	Rhaeto-	TT	Tatar
DZ	Bhutani	KL	Greenlandic		Romance	TW	Twi
EL	Greek	KM	Cambodian	RN	Kirundi	UK	Ukrainian
EN	English	KN	Kannada	RO	Romanian	UR	Urdu
EO	Esperanto	KO	Korean	RU	Russian	UZ	Uzbek
ES	Spanish	KS	Kashmiri	RW	Kinyarwanda	VI	Vietnamese
ET	Estonian	KU	Kurdish	SA	Sanskrit	VO	Volapük
EU	Basque	KY	Kirghiz	SD	Sindhi	WO	Wolof
FA	Persian	LA	Latin	SG	Sangho	XH	Xhosa
FI	Finnish	LN	Lingala	SH	Serbo-	YO	Yoruba
FJ	Fiji	LO	Laothian		Croatian	ZH	Chinese
FO	Faroese	LT	Lithuanian	SI	Singhalese	ZU	Zulu
FR	French	LV	Latvian, Lettish	SK	Slovak		

# MAINTENANCE

## Cleaning Disc

A defective or soiled disc inserted into the Unit can cause sound to drop out during playback.

Handle the disc by holding its inner and outer edges.

- Do NOT touch the surface of the unlabeled side of the disc.
- Do NOT stick paper or tape on the surface.
- Do NOT expose the disc to direct sunlight or excessive heat.
- Clean the disc before playback. Wipe the disc from the centre outwards with a cleaning cloth.
- NEVER use solvents such as benzine or alcohol to clean the disc.
- Do NOT use irregular shape discs (example : heart shaped, octagonal, etc.). They may cause malfunctions.

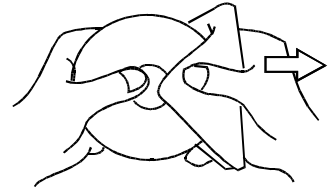

## Cleaning the Unit

- Be sure to turn the Unit off and disconnect the AC power cord before maintaining the Unit.
- Wipe the Unit with a dry soft cloth.  
If the surfaces are extremely dirty, wipe clean with a cloth which has been dipped in a weak soap-and-water solution and wrung out thoroughly, then wipe with a dry cloth.
- Never use alcohol, benzine, thinner, cleaning fluid or other chemicals. And do NOT use compressed air to remove dust.

## Important Note

Before transporting the Unit, remove disc from the CD tray.

# TROUBLE SHOOTING GUIDE

## SYMPTOM

## CAUSE (AND REMEDY)

No power.

- Check that the AC power cord is connected.

No picture.

- The region number of the disc doesn't match the region number of this Unit.



- The TV is not set to receive DVD signal output.
- The video cable is not connected.
- The TV is not turned on.

The picture is not clear.

- Clean the disc.
- If video from your system has to go through your VCR to get to your TV, the copy-protection applied to some DVD programs could affect picture quality. If you still experience problems after checking your connections, please try connecting your Unit directly to your TV through the S-Video-input, if your TV is equipped with this input.
- The disc is scratched.
- The DVD unit may be set to progressive scan, moreover TV does not support Progressive Scan component video signal. Press the P.SCAN button repeatedly until the "CVBS" display.

# TROUBLE SHOOTING GUIDE

## SYMPTOM

## CAUSE (AND REMEDY)

---

	<ul style="list-style-type: none"><li>• The location and orientation of the antenna are incorrect. If you use an indoor antenna, change to an outdoor antenna.</li><li>• The TV antenna wire is too close to the Unit. Separate the antenna wire of the TV set from the Unit.</li></ul>
No sound or only a very low-level sound is heard.	<ul style="list-style-type: none"><li>• Check that the speakers and equipment are connected securely.</li><li>• Make sure that you've selected the corrected equipment on the system.</li><li>• The system is in pause mode or in Slow-motion Play mode. Press the ► <b>PLAY</b> button to return to normal play mode.</li><li>• Fast forward or fast reverse is performed. Press the ► <b>PLAY</b> button to return to normal play mode.</li><li>• Check the speaker settings.</li><li>• Make sure that AUDIO output and AV IN input connections correct.</li><li>• Adjust the speakers volume.</li><li>• The DTS DVD disc cannot be decoded to have speaker output.</li><li>• This Unit is too hot, shut off half 30 minutes for cool down.</li><li>• You can use the Pink Noise setting to test that the speaker output is present (Please see Customizing the Function Settings)</li></ul>
Severe hum or noise is heard.	<ul style="list-style-type: none"><li>• Check that the speakers and equipment are connected securely.</li><li>• Check that the connecting cords are away from a transformer or motor, and at least 10 feet (3 meters) away from a TV set or fluorescent light.</li><li>• Move your TV away from the audio equipment.</li><li>• The plugs and jacks are dirty. Wipe them with a cloth slightly moistened with alcohol.</li><li>• Clean the disc.</li><li>• Vibrations from the speakers are affecting the Unit.</li></ul>
The remote does not function.	<ul style="list-style-type: none"><li>• Remove any obstacles between the remote and the Unit.</li><li>• Use the remote near the Unit.</li><li>• Point the remote at the remote sensor on the Unit.</li><li>• Replace all the batteries in the remote with new ones.</li></ul>
The disc does not play.	<ul style="list-style-type: none"><li>• There is no disc inside ("No Disc" appears on the TV screen).</li><li>• Insert the disc correctly with the playback side facing down on the disc tray.</li><li>• Clean the disc.</li><li>• A non-NTSC or non-PAL disc has been inserted. The Unit and disc region numbers are incompatible. Press the NTSC/PAL button on the remote to output the video signal.</li><li>• Condensation may have formed inside the Unit due to a sudden change in temperature. Wait about an hour for it to clear and try again.</li></ul>
The DVD door cannot open.	<ul style="list-style-type: none"><li>• Reset the Unit, press the <b>STANDBY/ON</b> button to turn off the Unit, wait for a few seconds, then restart the Unit again.</li></ul>



## Free Manuals Download Website

<http://myh66.com>

<http://usermanuals.us>

<http://www.somanuals.com>

<http://www.4manuals.cc>

<http://www.manual-lib.com>

<http://www.404manual.com>

<http://www.luxmanual.com>

<http://aubethermostatmanual.com>

Golf course search by state

<http://golfingnear.com>

Email search by domain

<http://emailbydomain.com>

Auto manuals search

<http://auto.somanuals.com>

TV manuals search

<http://tv.somanuals.com>