

DVD DVD  
DVD DVD

# Portable DVD Player with LCD Display

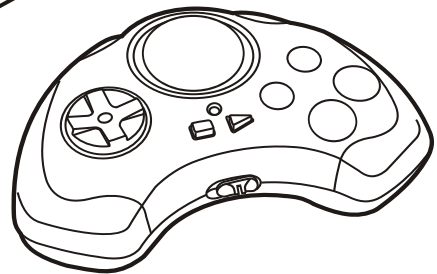
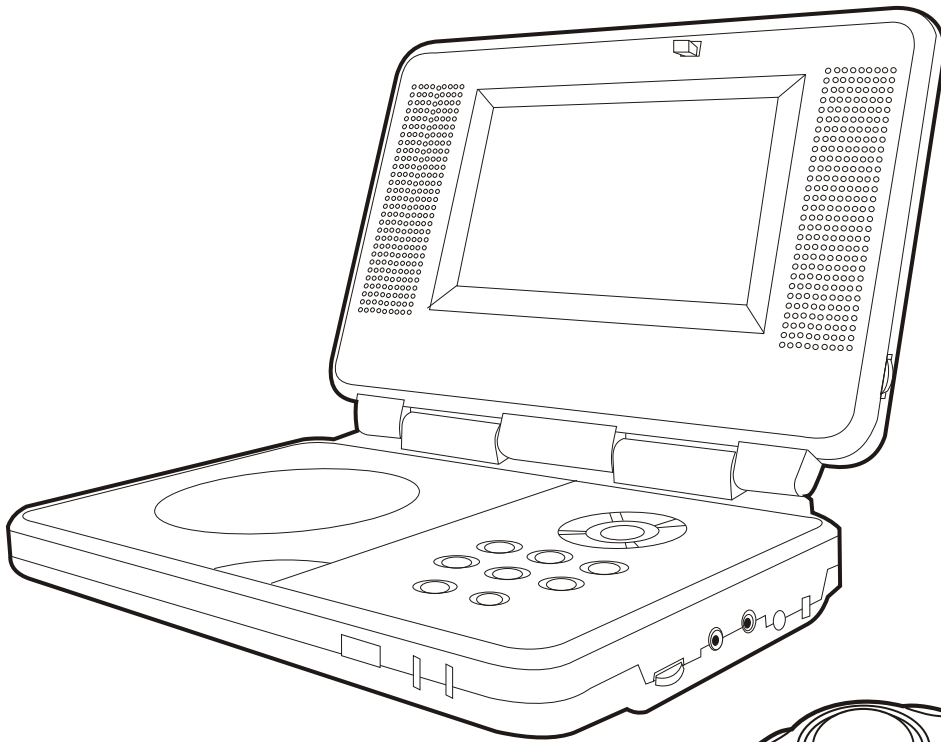

**OWNER'S MANUAL**

# SAFETY PRECAUTIONS

The following mark and symbols are located on bottom of the unit.



The lightning flash with an arrowhead symbol, within the equilateral triangle, is intended to alert the user to the presence of uninsulated "dangerous voltage" within the product's enclosure that may be of sufficient magnitude to cause an electric shock.



The exclamation point within the equilateral triangle is intended to alert the user to the presence of important operating and maintenance (servicing) instructions in this owner manual.

Marking sign is located on bottom of the unit.

**⚠ WARNING: TO REDUCE THE RISK OF ELECTRIC SHOCK, DO NOT REMOVE COVER (OR BACK). NO USER-SERVICEABLE PARTS INSIDE. REFER SERVICING TO QUALIFIED SERVICE PERSONNEL.**

**CAUTION**  
INVISIBLE LASER RADIATION  
WHEN OPEN AND INTERLOCKS  
DEFEATED.  
AVOID EXPOSURE TO BEAM

**⚠ WARNING: TO PREVENT FIRE OR SHOCK HAZARD, DO NOT EXPOSE THIS APPLIANCE TO RAIN OR MOISTURE. CAUTION: TO PREVENT ELECTRIC SHOCK, MATCHWIDE BLADE OF PLUG TO WIDE SLOT, FULLY INSERT. DANGER OF EXPLOSION IF BATTERY IS INCORRECTLY REPLACED. REPLACE ONLY WITH THE SAME OR EQUIVALENT TYPE.**

 This product contains a low power laser device.

 The symbol for Class II (Double Insulation)

## On Placement

- Do not use the unit in places which are extremely hot, cold, dusty, or humid.
- Do not restrict the air flow of the unit by placing it in a place with poor air flow, by covering it with a cloth, or by placing it on carpeting.

## On Safety

- When connecting or disconnecting the AC cord, grip the plug and not the cord itself. Pulling the cord may damage it and create a hazard.
- When you are not going to use the unit for a long period of time, disconnect the AC power cord.

## On Condensation

- When left in a heated room where it is warm and damp, water droplets or condensation may form inside the unit. When there is condensation inside the unit, the unit may not function normally. Let the unit stand for 1 to 2 hours before turning the power on, or gradually heat the room and dry the unit before use.

## FCC Information

**WARNING:** Changes or modifications to this unit not expressly approved by the party responsible for compliance could void the user authority to operate the equipment.

**NOTE:** This equipment has been tested and found to comply with the limits for a Class B digital device, pursuant to Part 15 of the FCC Rules. These limits are designed to provide reasonable protection against harmful interference in a residential installation. This equipment, used in accordance with the instructions, may cause harmful interference to radio communications.

However, there is no guarantee that interference will not occur in a particular installation. If this equipment does cause harmful interference to radio or television reception, which can be determined by turning the equipment off and on, the user is encouraged to try to correct the interference by one or more of the following measures:

- Reorient or relocate the receiving antenna.
- Increase the separation between the equipment and receiver.
- Connect the equipment into an outlet on a circuit different from that to which the receiver is connected.
- Consult the dealer or an experienced radio/TV technician for help.

Shielded cables must be used with this unit to ensure compliance with the Class FCC limits.

**⚠ WARNING:**

- Should any trouble occur, disconnect the AC power cord and refer servicing to a qualified technician.

## Notes on Copyright

It is forbidden by law to copy, broadcast, show, broadcast on cable, play in public or rent copyrighted material without permission. Apparatus Claims of U.S. Patent Nos. 4,631,603; 4,577,216; 4,819,098 and 4,907,093 licensed for limited viewing uses only.

DVD video discs are copy protected, and any recordings made from these discs will be distorted. This product incorporates copyright protection technology that is protected by method claims of certain U.S. patents and other intellectual property rights owned by Macrovision Corporation and other rights owners. Use of this copyright protection technology must be authorized by Macrovision Corporation, and is intended for home and other limited viewing uses only, unless otherwise authorized by Macrovision Corporation. Reverse engineering or disassembly is prohibited.

# IMPORTANT SAFETY INSTRUCTIONS

- 1) Read these instructions.
- 2) Keep these instructions.
- 3) Heed all warnings.
- 4) Follow all instructions.
- 5) Do not use this apparatus near water.
- 6) Clean only with dry cloth.
- 7) Do not block any ventilation openings. Install in accordance with the manufacturer's instructions.
- 8) Do not install near any heat sources such as radiators, heat registers, stoves, or other apparatus (including amplifiers) that produce heat.
- 9) Do not defeat the safety purpose of the polarized or grounding-type plug. A polarized plug has two blades with one wider than the other. A grounding type plug has two blades and a third grounding prong. The wide blade or the third prong are provided for your safety. If the provided plug does not fit into your outlet, consult an electrician for replacement of the obsolete outlet.
- 10) Protect the power cord from being walked on or pinched particularly at plugs, convenience receptacles, and the point where they exit from the apparatus.
- 11) Only use detachments/accessories specified by the manufacturer.
- 12) Use only with the cart, stand, tripod, bracket, or table specified by the manufacturer, or sold with the apparatus. When a cart is used, use caution when moving the cart/apparatus combination to avoid injury from tip-over.
- 13) Unplug this apparatus during lightning storms or when unused for long periods of time.
- 14) Refer all servicing to qualified service personnel. Servicing is required when the apparatus has been damaged in any way, such as power-supply cord or plug is damaged, liquid has been spilled or objects have fallen into the apparatus, the apparatus has been exposed to rain or moisture, does not operate normally, or has been dropped.



# TABLE OF CONTENTS

<b>Safety Precautions</b> .....	<b>1</b>
<b>Important Safety Instruction</b> .....	<b>2</b>
<b>Table Of Contents</b> .....	<b>3</b>
<b>Disc Formats</b> .....	<b>4</b>
<b>Accessories</b> .....	<b>5</b>
<b>Remote Control</b> .....	<b>5</b>
<b>Control Reference Guide</b> .....	<b>6-7</b>
<b>Power Supply</b> .....	<b>8-10</b>
Using the AC adaptor .....	8
Using the car adaptor .....	8
Using the rechargeable battery pack .....	9-10
Turning on the unit .....	10
<b>Connecting other Equipment</b> .....	<b>11-13</b>
Connecting the game consoles/ other video equipment .....	11
Connecting a TV .....	11
Another source connection .....	12
Using headphone/earphones .....	13
<b>Adjusting the Sound</b> .....	<b>13</b>
<b>Playing a Disc</b> .....	<b>14-16</b>
Playing a Disc .....	14
Pausing playback (still mode) .....	14
Stopping playback .....	14
To skip to a different track .....	14
Fast Foward/Fast Reverse .....	15
Zooming into an image .....	15
Angle selection .....	16
Audio selection .....	16
Subtitle selection .....	16
<b>Special Functions</b> .....	<b>17-19</b>
Display function .....	17
Locating a specific title .....	18
Locating a specific title/chapter/track .....	18
Locating a specific time .....	19
Angle setting .....	19
Audio setting .....	19
Subtitle setting .....	19
<b>CD / DVD programmable memory</b> .....	<b>20</b>
DVD programmable memory .....	20
CD programmable memory .....	20
<b>Repeat Playback</b> .....	<b>21-22</b>
Repeating a title/chapter (DVD) .....	21
Repeating a single track/whole disc (CD) .....	21
Repeating a specific section (DVD/CD) .....	22
<b>Playing Picture File Disc</b> .....	<b>23</b>
Playing a Picture file disc .....	23
<b>Customizing the Function Settings</b> .....	<b>24-26</b>
LANGUAGE setting .....	24
VIDEO setting .....	24-25
AUDIO setting .....	25-26
RATING setting .....	26
<b>Language Code List for Disc Language</b> .....	<b>27</b>
<b>Maintenance</b> .....	<b>28</b>
Cleaning Disc .....	28
Cleaning the Unit .....	28
Important Note .....	28
<b>Trouble Shooting Guide</b> .....	<b>29</b>
<b>Carrying Bag installation</b> .....	<b>30</b>
<b>Game Pad (Connections)</b> .....	<b>31</b>

# DISC FORMATS

The unit can playback



DVDs  
[8cm/12cm disc]



**CD-R CD-RW**  
Compatible



Audio CDs  
[8cm/12cm disc]

## Region Management Information

Region Management Information: This unit is designed and manufactured to respond to the Region Management Information that is encoded on DVD discs. If the Region number printed on the DVD disc does not correspond to the Region number of this unit, this unit cannot play that disc.



The region number of this unit is 1.

## Disc Function or Operation that is Not Available

When the  symbol appears on the screen, it indicates that the function or operation attempted is not available at that time. This occurs because the DVD disc manufacturer determines the specific functions. Certain functions may not be available on some discs. Be sure to read the documentation provided with the DVD.

## Icons Used on DVDs

Sample Icons

	1. English 2. French	Language selections for audio
	1. English 2. French	Language selections for subtitles
	16:9	Screen aspect ratio
	2	Multiple camera angles
		Region code indicator

## Notes:

- This Unit supports 2-channel (L/R) audio and 5.1ch (Multi-channel) MPEG Audio 1/2 (only when the DIGITAL AUDIO OUT coaxial jack is used for connection). It does not support 7.1 channel MPEG Audio Version 2.0.
- When playing back a CD-G (Graphics) or CD EXTRA disc, the audio portion will be played, but the graphic images will not be shown.

## Title, Chapter and Tracks

- DVDs are divided into “titles” and “chapters”. If the disc has more than one movie on it, each movie would be a separate “title”. “Chapters” are sections of titles.

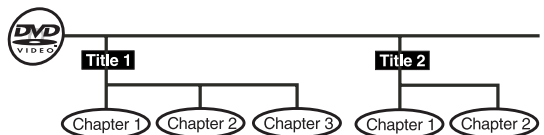

- Audio CDs are divided into “tracks”. A “track” is usually one song on an Audio CD.



## Note :

- Numbers identify each title, chapter, and track on a disc. Most discs have these numbers recorded on them, but some do not.

### Notes on Unauthorized Discs

You may not be able to play back some DVD discs on this unit if they were purchased from outside your geographic area or made for business purposes.

# ACCESSORIES

**Please check and identify the supplied accessories.**

**Use numbers indicated in parentheses when asking for replacement parts.**

• To order accessories contact 1-800-252-6123 or wed sits (<http://www.1800customersupport.com>)

- Remote control (with battery) (043-R13232-011) ..... x 1
- AC adaptor (133-010902-003) ..... x 1
- AC power cord (134-A13211-20P) ..... x 1
- Car power adaptor (133-030025-000) ..... x 1
- Rechargeable battery pack (Model no.: BATT-2P) ..... x 1
- Battery charger (Model no.: CHRR-2) ..... x 1
- Audio/Video cable (122-004020-013) ..... x 1
- Game pad (046-GP600A-N01) ..... x 1
- Carrying bag (803-P177A0-000) ..... x 1

## REMOTE CONTROL

### Using the Remote Control

- Point the Remote Control at the REMOTE SENSOR located on the unit.
- When there is a strong ambient light source, the performance of the infrared REMOTE SENSOR may be degraded, causing unreliable operation.
- The recommended effective distance for remote operation is about 16 feet (5 meters).

Take out the PVC sheet before operating the Remote Control.

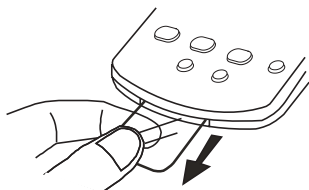

### TO CHANGE REMOTE BATTERY

1. Open the battery door.
2. Insert one CR2025 (3V) size battery.

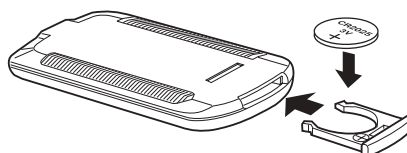
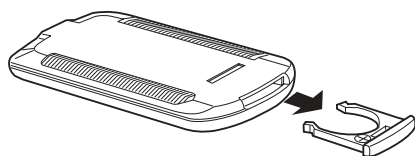

### BATTERY REPLACEMENT

When battery becomes weak, the operating distance of the Remote Control will greatly reduced and you will need to replace the battery.

#### NOTE:

- If the Remote Control is not to be used for a long time, remove the battery to avoid damage caused by battery leakage corrosion.
- **WARNING:** Do not dispose of batteries in fire, batteries may explode or leak.

# CONTROL REFERENCE GUIDE

## Remote Control

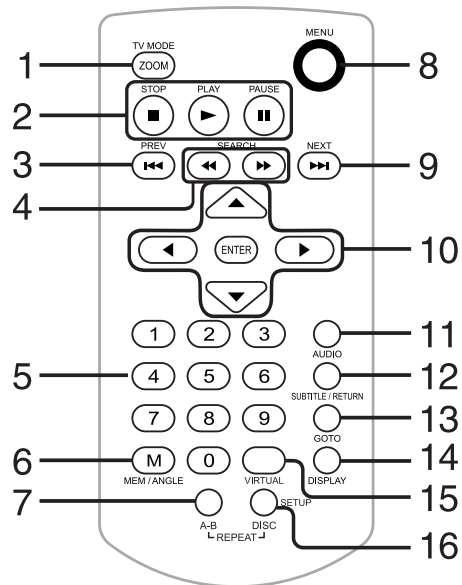

### 1) ZOOM button

Zoom into an image of a DVD.

#### TV MODE button

In stop mode, select whether to output the video signal. TV shows "AUTO" means output signal depends on DVD (either NTSC or PAL). TV shows "PAL" or "NTSC" which means output signal fixed to PAL or NTSC.

### 2) ■ STOP button

Stop playing a disc.

#### ▶ PLAY button

Press to start or resume playback a disc.

#### || PAUSE button

Pause playback, frame advance.

### 3) ◀◀ PREVIOUS button

Move reverse through titles, chapters or tracks on a disc.

### 4) ◀◀ / ▶▶ SEARCH buttons

◀◀ SEARCH: Fast reverse playback.

▶▶ SEARCH: Fast forward playback.

### 5) Number (0 - 9) buttons

Use when creating programs, and entering a parental level password. To select a CD/MP3 track directly.

### 6) MEM / ANGLE button

In stop mode, enter the number of a selected chapter or track.

During DVD playing, switch the camera angle of the video presentation when scenes with multiple camera angles are recorded on a DVD.

### 7) REPEAT A - B button

Perform point-to-point repeat playback on a DVD or CD.

### 8) MENU button

Open and close DVD menu.

### 9) ▶▶ NEXT button

Move forward through titles, chapters or tracks on a disc.

### 10) Cursor (▼, ▲, ◀, ▶) buttons

Use to highlight selections on a menu screen and make adjust certain settings.

#### ENTER button

Confirm selections on a menu screen.

### 11) AUDIO button

Select one of the audio sound tracks programmed on a DVD or selects the audio output mode on a AUDIO CD.

### 12) SUBTITLE/RETURN button

Select one of the subtitle languages programmed on a DVD.

Return to the normal operation after using the SETUP menu of a DVD.

### 13) GOTO button

Skip directly to a specific location on a DVD disc.

### 14) DISPLAY button

Change disc status information displayed on the screen.

### 15) VIRTUAL button

To obtain expansive virtual surround sound effects from just two speakers.

### 16) SETUP/REPEAT-DISC button

In stop mode, Open and close the SETUP menu of the unit.

Repeat chapter or title of a DVD.

Repeat single track or whole CD.

# CONTROL REFERENCE GUIDE

## Unit

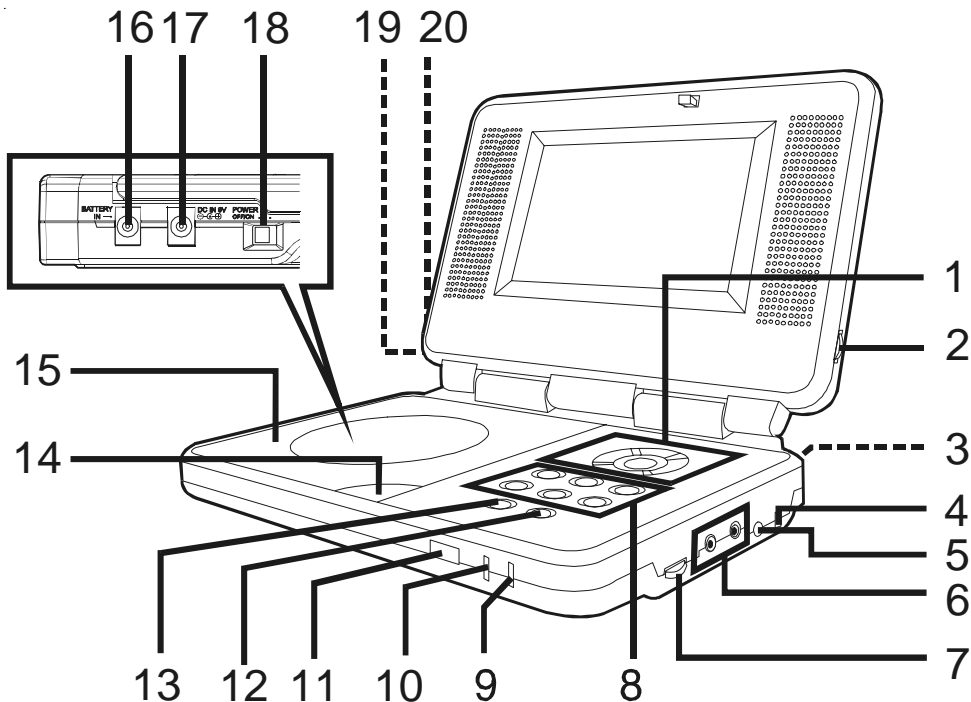

- 1) **Cursor (↙, ↘, ↗, ↖) button**  
Use to highlight selections on a menu screen and make adjust certain settings.  
**ENTER button**  
Confirm selections on a menu screen.
- 2) **BRIGHTNESS button**  
Adjust the relative lightness or darkness of the colour.
- 3) **DIGITAL OUT jack**
- 4) **AV IN / DVD switch**  
Turn off to AV IN mode. Turn into DVD mode.
- 5) **AV IN / OUT jacks**
- 6) **Headphone jacks**
- 7) **VOLUME control**  
Adjust the volume.
- 8) **ZOOM button**  
Zoom into an image of a DVD.  
**AUDIO button**  
Select one of the audio soundtracks programmed on a DVD or selects the audio output mode on a AUDIOCD.  
**MENU button**  
Open and close DVD's menu.  
**◀◀ PREV button**  
Press ◀◀ **PREV** button to go back to previous chapters /tracks. Press and hold ◀◀ **PREV** button to begin fast scan. Four speeds are available.  
**▶▶ NEXT button**  
Press ▶▶ **NEXT** button to advance to chapters / tracks. Press and hold ▶▶ **NEXT** button to begin fast scan. Four speeds are available.

- 11) **PAUSE/SETUP button**  
Press to pause playback of disc. Each time you press the PAUSE button the picture advances one frame. Press the PLAY ▶ button to resume playback. In stop mode, open and close the SETUP menu of the unit.
- 9) **Battery low indicator**
- 10) **POWER ON indicator**  
When the **POWER ON/OFF** button is switched to ON position, the light will illuminate.
- 11) **Remote sensor**  
Receive the remote control unit signals.
- 12) **▶ PLAY button**  
Press to start or resume playback a disc.
- 13) **■ STOP button**  
Stop playing a disc.
- 14) **Open button**  
Open the disc door.
- 15) **Disc Door**  
Close tray by pushing the disc door.
- 16) **Battery in jack**
- 17) **DC IN 9V jack**
- 18) **POWER ON/OFF switch**
- 19) **SCREEN switch**  
Wide screen  
Normal screen
- 20) **COLOUR control**  
Adjust for colour intensity.



# POWER SUPPLY

## A. Using the AC adaptor

This AC adaptor operates on AC between 100V and 240V, but

- In the U.S.A. and Canada, the AC power supply cord must be connected to a 120V AC power supply only.
- When connecting to an AC supply outside of the U.S.A. and Canada, use a plug adaptor to suit the AC outlet configuration.

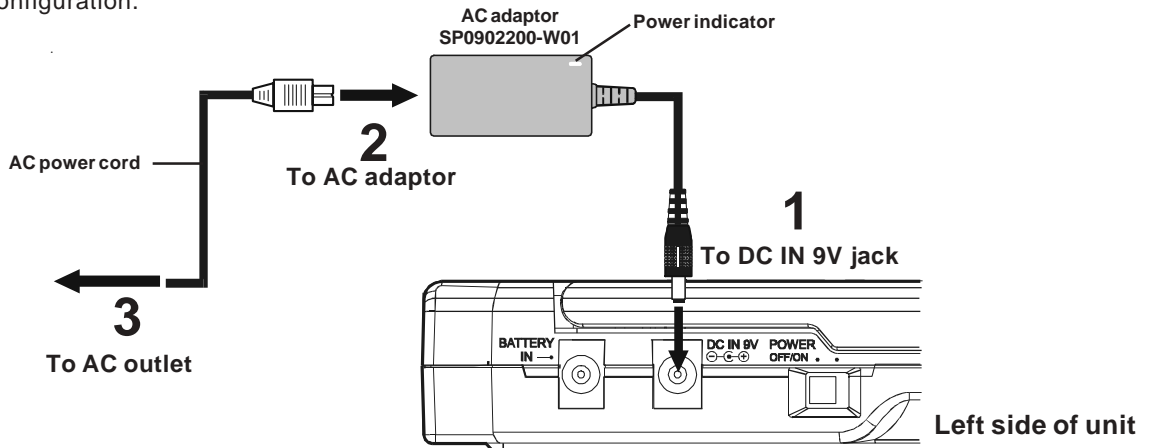

### Cautions:

- The included AC power supply cord and AC adaptor are for use with this unit only. Do not use them with other equipment.
- **To prevent electrical shock, match wide blade of plug to wide slot, fully insert.**
- When the unit is not going to be used for long time, disconnect the AC power supply cord from the AC outlet.

## B. Using the car power adaptor

The included 9V car power adaptor is designed for use with vehicles that have a 12V, negative ground electrical system.

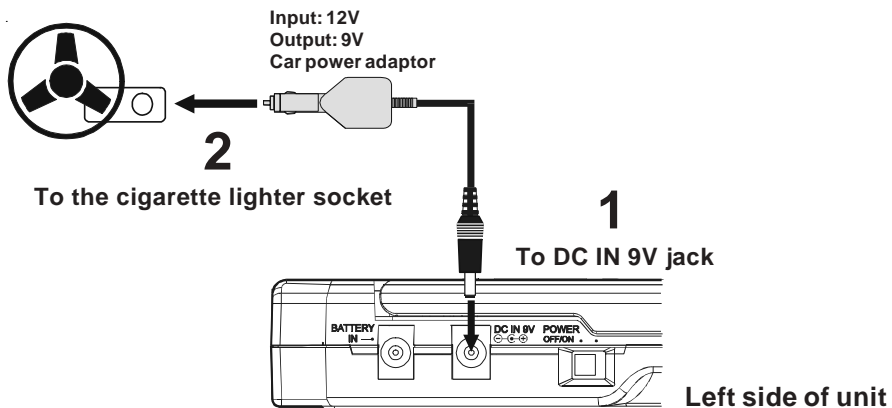

### Cautions:

- Use this unit only with the included 9V car power adaptor, use with other car adaptor could damage the unit.
- The included 9V car power adaptor are for use with this unit only. Do not use them with other equipment.
- In the interests of the traffic safety, do not perform operations on the unit or view video software while driving a vehicle.
- Make sure the unit is fastened correctly to prevent from falling in the vehicle in the event of an accident.
- When the inside of the cigarette lighter socket is dirty with ashes or dust, the plug section may become hot due to poor contact. Be sure to clean the cigarette lighter socket before use.
- After use, disconnect the 9V car power adaptor from both the unit and cigarette lighter socket.

# POWER SUPPLY

## C. Using the rechargeable battery pack

- Charge the rechargeable battery pack before using them for the first time.
- The rechargeable battery pack is suitable when adapting the unit for portable use and when it is convenient for you to enjoy the unique functions of the unit out of doors.
- To recharge the battery  
Remove the rechargeable battery pack from the unit (if being used).

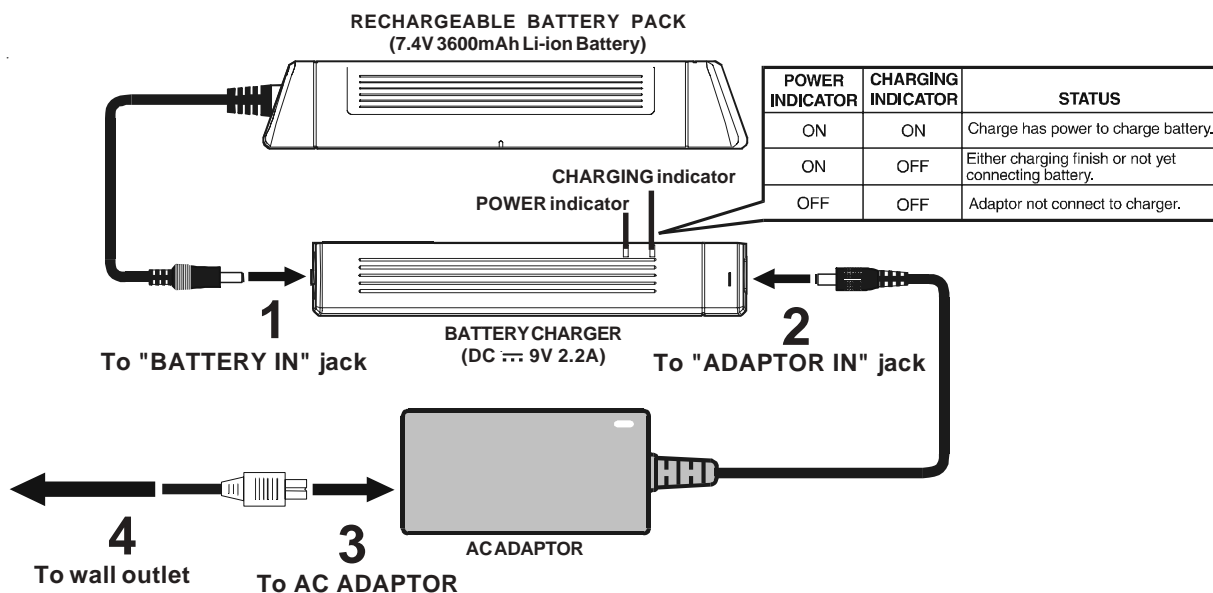

### Cautions:

- The included AC power supply cord and AC adaptor are for use with this unit only. Do not use them with other equipment.
- **To prevent electrical shock, match wide blade of plug to wide slot, fully insert.**
- When the unit is not going to be used for long time, disconnect the AC power supply cord from the AC outlet.
- Recharging is complete when charging indicator goes out. Unplug the AC power supply cord from the AC adaptor, then unplug the battery pack from the battery charge.
- To attach rechargeable battery pack  
Attach it at the corresponding position at the back of the unit.

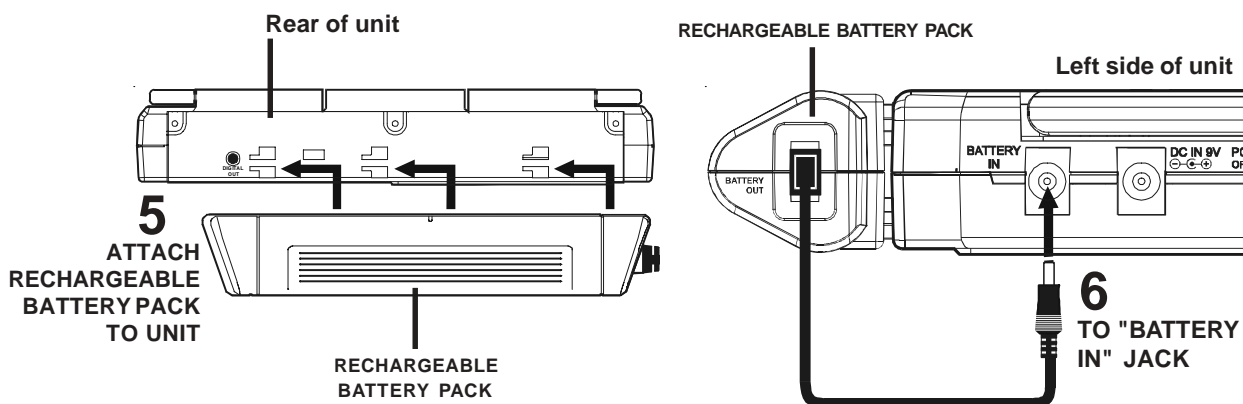

# POWER SUPPLY

- Disconnecting the Battery Pack to the unit.

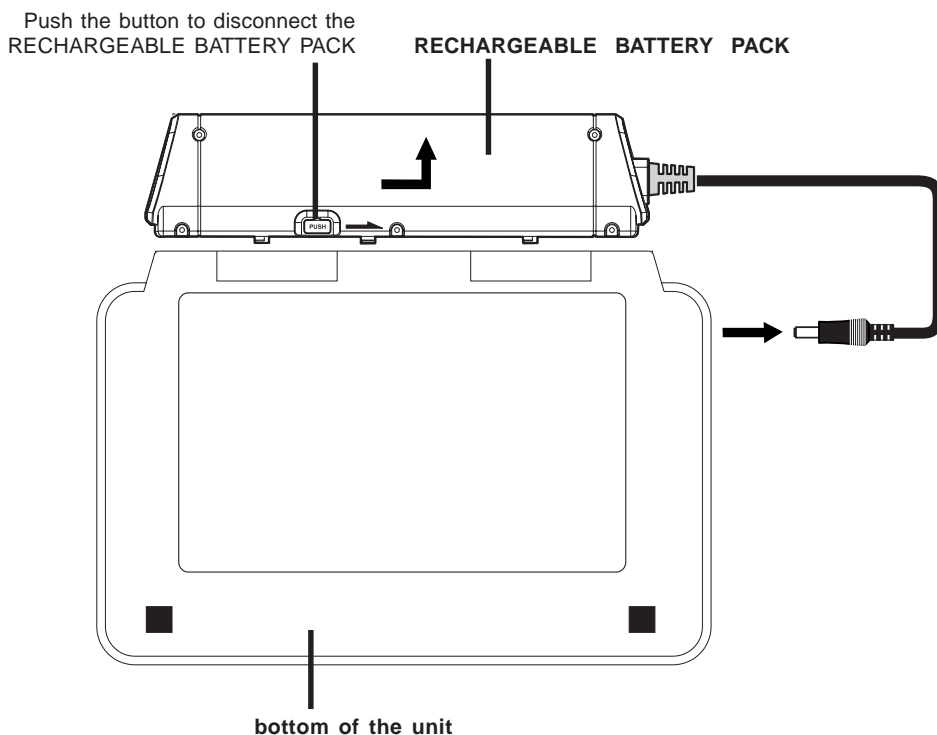

## **Condition and attention:**

- When RECHARGEABLE BATTERY PACK battery is low, player will stop playing.
- During the playback, if the battery is low, the BATTERY LOW indicator on the unit front panel will turn into red and blink. At this time, please recharge the battery.
- Do not short-circuit the terminals.
- Use only the supplied AC ADAPTOR and BATTERY CHARGER to recharge the rechargeable battery pack.
- Detach the battery pack. (Even if the unit is off, it still uses some power. This can lead to over discharging of the battery and malfunction.)
- Recharge the battery pack when you are ready to use it again.
- If the rechargeable battery pack is not to be used for a long period of time, discharge it and store it in a place that is cool, dry and dark.
- While using the rechargeable battery pack, the environmental temperature should be 5°C (41°F) to 35°C (95°F).
- To undertake the longest service life of the rechargeable battery pack, charge it under or close to indoor-temperature.
- Never dispose of in fire, water or heat up.
- Do not open the rechargeable battery pack, refer servicing only to qualified service personnel.

## **Turning on the unit**

1. Slide the **POWER ON/OFF** button to on position on the left side of unit.
2. Slide the **FUNCTION** button to DVD or AV IN mode on right side of unit.
  - If you select DVD the DVD logo (start-up picture) will appear on unit screen.



# CONNECTING OTHER EQUIPMENT

## A. Connecting the Game Consoles / other Video Equipment

- you can connect your Game Consoles or other Video Equipment to playback through the system.

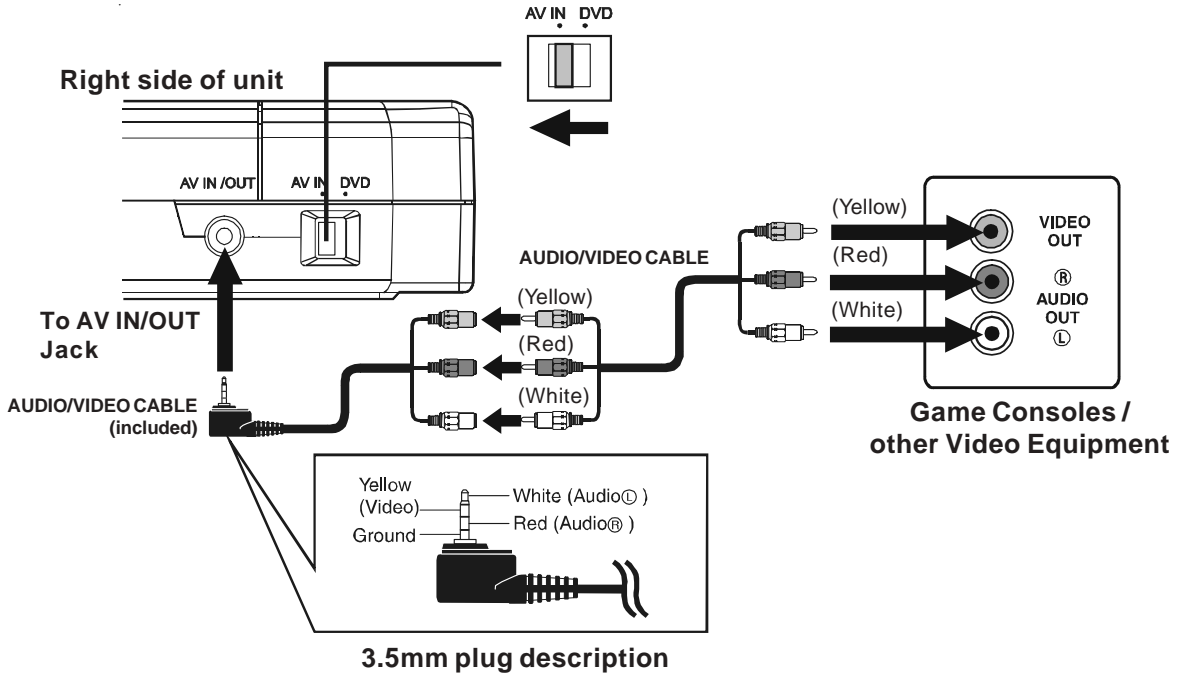

### Watching a Video Equipment

1. Turn on the unit, slide the **AV IN / DVD** button to select "AV IN".
2. Turn on the video equipment and follow the instructions provided with it to playback.

**Note:** If you have a mono VCR, the volume level from the speakers will be low.

## B. Connecting a TV

- If your TV has Audio/Video inputs, you can also connect the unit to your TV using the Audio/Video cable.

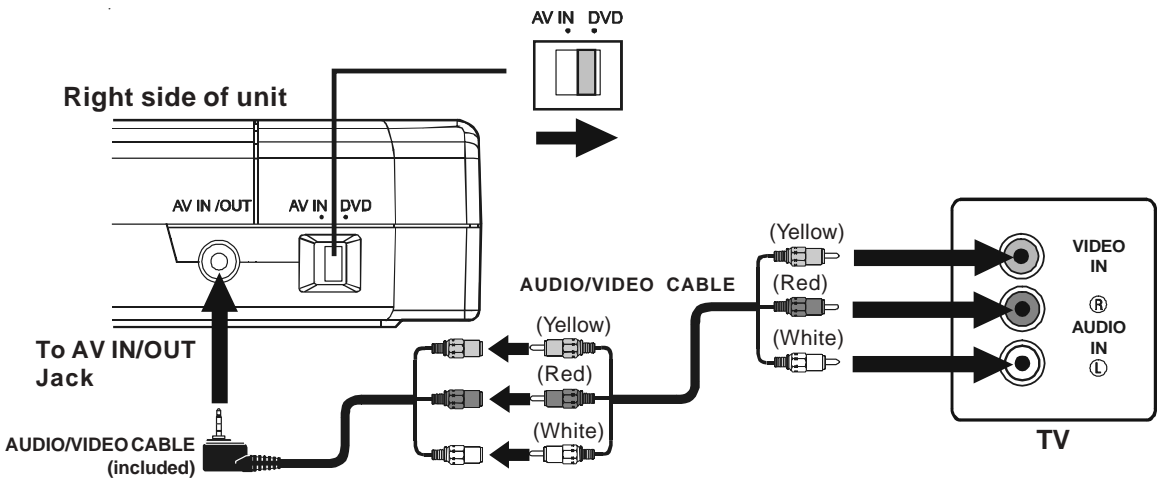

### Watching a DVD on your TV

1. Turn on the unit, slide the **AV IN / DVD** button to select "DVD".
2. Turn on the TV and follow the instructions included with it to play the DVD.

**Notes:** Please use connect Audio/Video cable.

# CONNECTING OTHER EQUIPMENT

## C. Another source connection

This unit can play Dolby Digital, but only in two channels.

### Analogue connection

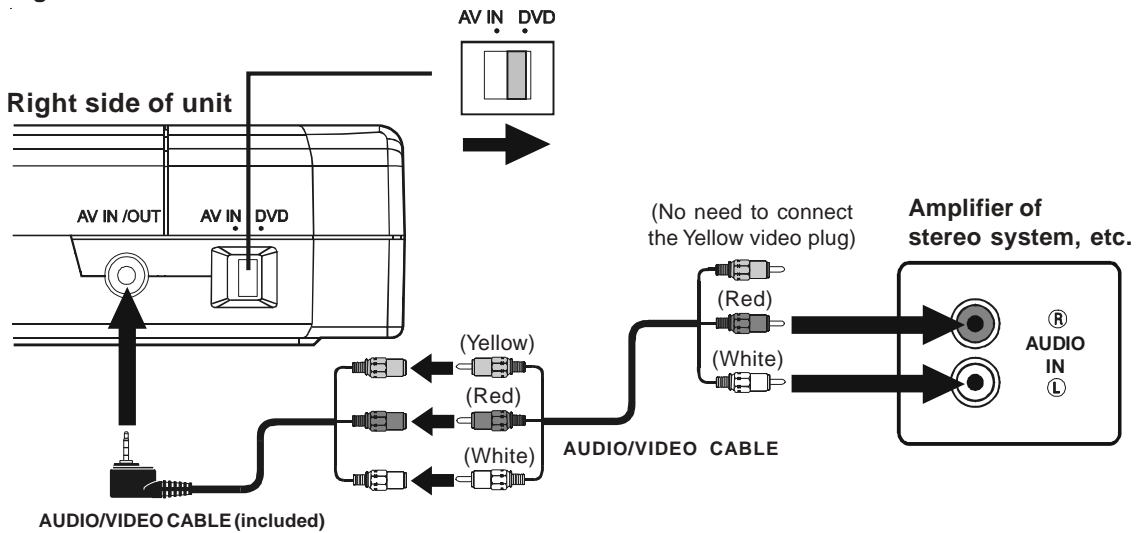

### Digital connection

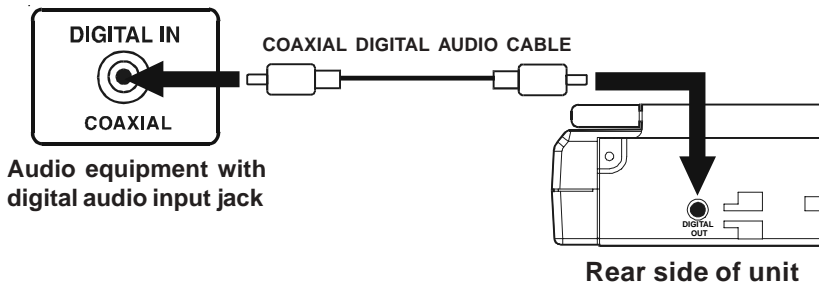

### Listening to another audio equipment

1. Turn on the Unit.
2. Turn on your audio equipment and follow the instructions included with it to select the AUDIO IN or DIGITAL IN function.

### Notes:

- If the external equipment is a television and this audio system is close to it, you may experience interference if the tuner function is selected while the television is working.
- Make sure to use correct Audio/Video cable, wrong plug connection may cause weak signal.
- If you have a stereo VCR, make sure you set it in stereo mode.
- Due to copyright protection, DVD movies cannot be copied. If you copy a DVD movie onto a videotape, the resulting copy will be unclear, with poor sound quality. This is NOT caused by a defective DVD system.

# CONNECTING OTHER EQUIPMENT

## Using Headphones/Earphones

- Turn down the volume before connection, and then adjust the level.
- When headphones/earphones are connected, no sound will be output from the unit's speakers.

### Caution:

- Avoid listening to sound at levels which may be harmful to your ears.

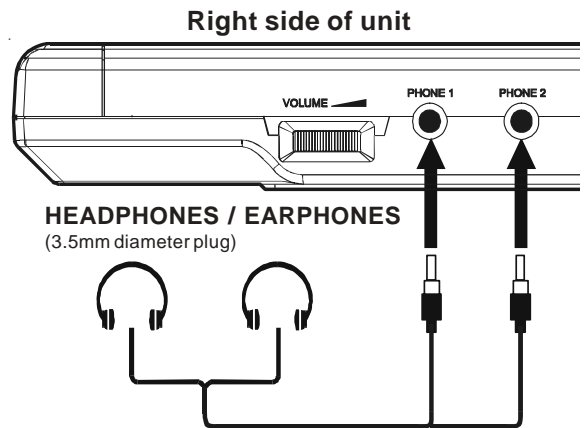

# ADJUSTING THE SOUND

## Dolby Digital (for DVD)

Dolby Digital is a sound system developed by Dolby Laboratories Inc. that gives movie theatre ambience to audio output when the unit is connected to a Dolby Digital 5.1 channel processor or amplifier.

This unit automatically recognizes DVDs that have been recorded with Dolby Digital.

Not all Dolby Digital sources are recorded with 6 channels.

Some sources marked Dolby Digital may be recorded in Dolby Surround, a 2 channel system. Look for this logo on your unit.



Manufactured under license from Dolby Laboratories.

'Dolby' and the double-D  symbol are trademarks of Dolby Laboratories.

This owner's manual explains the basic instructions of this unit. Some DVD discs are produced in a manner that allows specific or limited operation during playback. As such, the unit may not respond to all operating commands. This is not a defect in the unit. Refer to the instruction notes of discs.

“” may appear on the screen during operation. A “” means that the desired operation is not permitted by the unit or disc.

## ***Playing a Disc***

1. Slide the **POWER ON/OFF** button on the left side of unit into on mode.
2. Slide the **FUNCTION** button on the right side of unit to select DVD mode.

See **CUSTOMIZING THE FUNCTION SETTINGS** to step 3.

3. Press the **OPEN** button to open the disc door.
4. Hold the disc by its sides and carefully make it fit onto the central support of compartment with the label side facing up until you hear a “click”.
5. Close the disc door.  
It takes a short while for your unit to load the disc. After loading, for some discs, the unit will automatically start playback of the disc.
6. Press the **▶ PLAY** button.

## ***Pausing playback (still mode)***

Press the **|| PAUSE** button. To resume normal playback, press the **▶ PLAY** button.

## ***Stopping playback***

Press the **■ STOP** button at the location where you want to interrupt playback. To resume playback at the position where the disc was stopped, press the **▶ PLAY** button.

If you press the **■ STOP** button twice, the unit's memory will be cleared and pressing the **▶ PLAY** button will reset the disc to the beginning.

## ***To skip to a different track***

- Press the **◀◀ PREV** button repeatedly to skip to the start of the current or previous track.
- Press the **▶▶ NEXT** button to skip to the next track.
- For audio CD disc, use the number buttons (remote control only) to jump straight to that track number.

# PLAYING A DISC

## Fast Forward/Fast Reverse

1. Press the **SEARCH ►►** or **◄◄ SEARCH** button of the remote unit when a disc is playing.

- The disc begins fast scan at x2 speed.
- Four speeds are available. Each time **SEARCH ►►** or **◄◄ SEARCH** button is pressed, the speed of fast scan changes in the following sequence: ►► x 2 → ►► x 4 → ►► x 8 → ►► x 20

The speed of fast scan

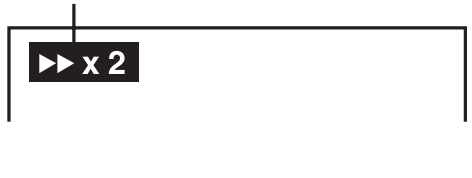

### Note :

You also can press and hold **◄◄ / ►►** (PREV/NEXT) buttons on unit repeatedly to select different fast scan speed.

2. Press the **► PLAY** button when you reach the desired point to resume playback at normal speed.

## Zooming into an image

While a disc is playing, press the **ZOOM** button of unit.

- While an image is zoomed, you can use **▲**, **▼**, **◄** and **►** button to shift the view and display the part you want.
- To return to the normal view, press the **ZOOM** button until the “**Qoff**” symbol shows. The screen will return to normal.

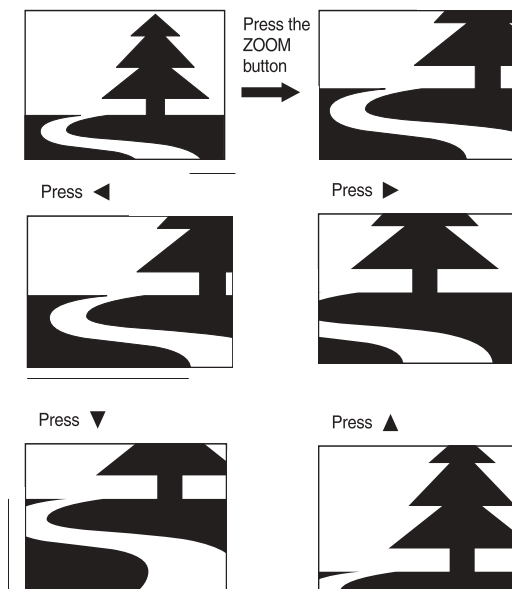

- When you reach the edge of the image, the display will not shift anymore in that direction.



## Angle selection

Some DVDs contain scenes which have been shot from a number of different angles. For these discs, the same scene can be viewed from each of these different angles.

1. While you are playing a DVD with different angles recorded, press the **ANGLE** button to view the number of the current angle.

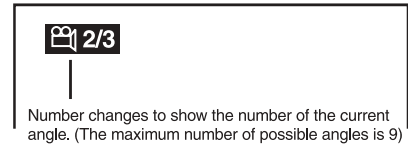

2. Press the **ANGLE** button repeatedly to change the scene to the next angle in those recorded.
  - About two seconds later, playback continues from the new angle you selected.
  - If no button is pressed within 10 seconds, playback continues without changing the current angle.

### Sequence of angle shots (Example)

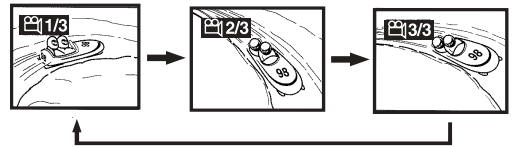

### Notes:

- This function can only be used for discs on which scenes shot from multiple angles have been recorded.
- If only one angle is recorded, "1/1" is displayed.

## Audio selection

On some discs, the sound is recorded in two or more formats. Follow the directions below to select the type of playback.

1. While a disc is playing, press the **AUDIO** button to show the current audio format number.
2. Press the **AUDIO** button repeatedly to select the desired audio format.

### Notes :

- If only one audio format is recorded, the number does not change.
- About two seconds later, playback continues in the new audio format.

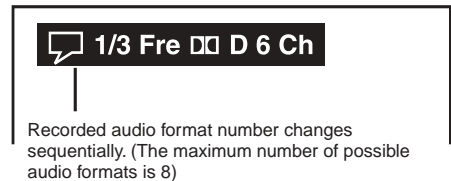

## Subtitle selection

1. While a DVD is playing, press the **SUBTITLE** button to display the current language setting, as shown in the example below.

1/3 Eng → 2/3 Spa → 3/3 Fre → Off

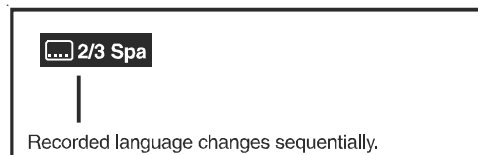

2. Press the **SUBTITLE** button repeatedly to select the desired subtitle language.

### Notes :

- If only one language is recorded, the language does not change.
- About two seconds later, playback continues with the new subtitle you selected.
- The number of languages recorded differs depending on the disc.
- If no button is pressed within a few seconds, playback continues without changing the current subtitle.
- This function can only be used for discs on which subtitles have been recorded in multiple languages.
- On some DVDs, subtitles are activated from the main menu of the DVD. Press the **MENU** button to activate the main menu.

## DISPLAY function

Using DISPLAY, you can check and change the current settings of the following items: ANGLE, AUDIO and SUBTITLE.

- While the disc is playing, press the **DISPLAY** button of the remote unit to display the screen shown below.

**Elapsed time:** Elapsed time from the beginning of the chapter which is currently playing.

**Remaining time:** Remaining time of the title which is currently playing.



- Press the **DISPLAY** button twice of the remote unit to display the screen shown as below.
- Press the **ANGLE**, **AUDIO** and **SUBTITLE** button to change the selected item.

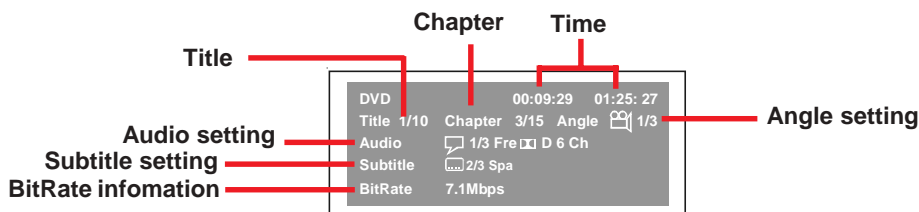

### Title skip

- The number of the title currently playing and total titles of disc.
- Press the **GOTO** button to set your desired title, then press the **ENTER** button to confirm.

### Chapter skip

- The number of the chapter currently playing and total chapters of the currently played title.
- Press the **GOTO** button to set your desired chapter, then press the **ENTER** button to confirm.

### Time skip

- Elapsed time from the beginning of the currently playing chapter and the remaining time from the beginning of the currently playing title.
- Press the **GOTO** button to set your desired point to start playback, then press the **ENTER** button to confirm.

### Angle setting

- The current angle is displayed. When a disc with only one angle is played back, "1/1" is displayed.
- Press the **ANGLE** button to select the desired angle.

### Audio setting

- The type of audio currently selected is displayed.
- Press the **AUDIO** button to select your desired type of audio.

### Subtitle setting

- The subtitle number and language currently selected is displayed. When a disc with only one subtitle is played back, "1/1 Eng" is displayed.
- Press the **SUBTITLE** button to select your desired language.

## GOTO function

This function allows you to skip directly to any part of the disc while a disc is playing.

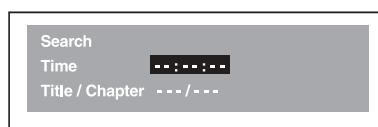

### Note :

- After setting, press the **DISPLAY** button again of the remote unit to return to the normal screen.

### Locating a specific title

If a DVD disc contains title numbers, you can locate a specific title by directly selecting a title number.

1. Press the **GOTO** button.
2. Press **▼**, **◀** or **▶** button to highlight a specific field and press the corresponding number button(s) for the title you want.
3. Press the **ENTER** button to confirm. The unit will start playback about 3 seconds later.

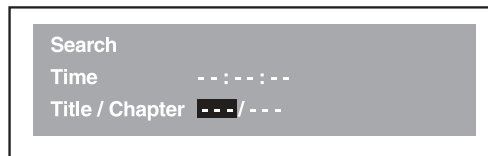

### Locating a specific title / chapter / track

If you know the title / chapter / track number you want to play, you can locate a specific title / chapter / track by directly selecting a title / chapter / track number.

1. Press the **GOTO** button to search your desired title / chapter / track.
2. Press **▼**, **◀** or **▶** button to highlight a title / chapter / track and press the corresponding number button(s) for the chapter you want.
3. Press the **ENTER** button to confirm. The unit will start playback about 3 seconds later.

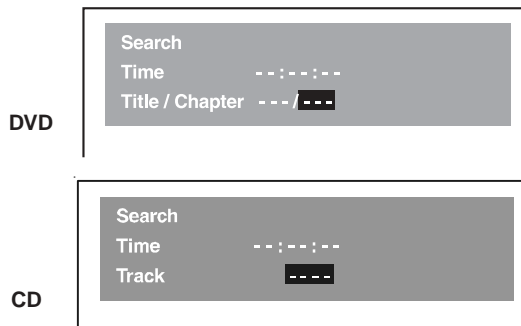

(continued on next page)

## Locating a specific time

You can move to a specific location by entering its corresponding time (hours, minutes, seconds)

1. Press the **GOTO** button.
2. Press **▲** or **▼** button to highlight time.



3. Press the corresponding number buttons for the setting point you want.
  - The first two numbers you entered represent hours.
  - The second two numbers you entered represent minutes.
  - The third two numbers you entered represent seconds.
4. Press the **ENTER** button to confirm. The unit will start playback about 3 seconds later.

### Notes :

- Some discs may not respond to this process.
- Some scenes may not be located as precisely as you specified.
- This method for accessing specific locations is available only within the current title of the DVD disc.
- You can move through the menu by pressing the **▲** and **▼** buttons.

## Angle setting

1. Press the **DISPLAY** button twice of the remote unit. The **FUNCTION** menu is displayed on the screen and you can see how many angles are recorded on the disc.
2. Press the **ANGLE** button repeatedly to select your desired angle.
3. The unit change to your desired angle at once.



## Audio setting

1. Press the **DISPLAY** button twice of the remote unit. The **FUNCTION** menu is displayed on the screen and you can see how many audio formats are recorded on the disc.
2. Press the **AUDIO** button repeatedly to select your desired type of audio.
3. The unit change to your desired type audio at once.

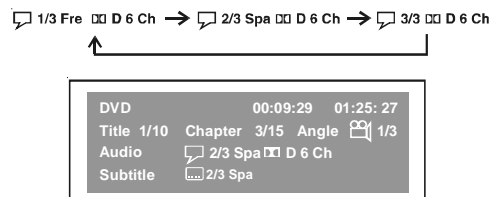

## Subtitle setting

1. Press the **DISPLAY** button twice of the remote unit. The **FUNCTION** menu is displayed on the screen and you can see how many subtitle formats are recorded on the disc.
2. Press the **SUBTITLE** button repeatedly to select your desired language.
3. The unit change to your desired language about 3 seconds later.



## Programmable memory

The two types of programmed playback provided by this unit are title/chapter programmed playback and title programmed playback.

### Title / Chapter programmed playback

1. Press the **MEM** (Memory) button while the disc is stopped.
2. Enter the title numbers in **--**. Use **◀** or **▶** button to move the highlight to chapter and enter the chapter numbers in **--**.

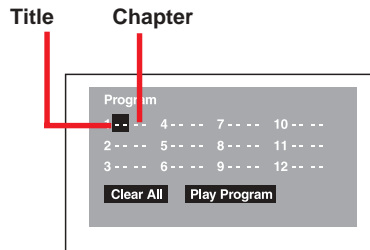

3. Use **◀**, **▶**, **▲** or **▼** button to move to the other field.
4. Repeat steps 2 to 3.
5. Press the **▶ PLAY** button to start the programmed playback.

### Programmable memory

#### Track programmed playback

1. Press the **MEM** (Memory) button while the disc is stopped.
2. Enter the track numbers in **---**.

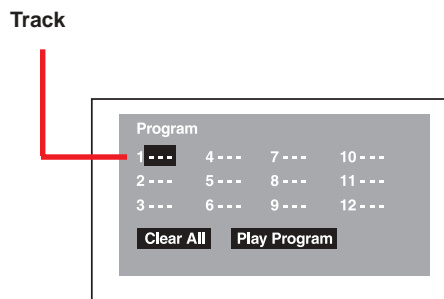

3. Use **◀**, **▶**, **▲** or **▼** button to other field.
4. Repeat steps 2 to 3.
5. Press the **▶ PLAY** button to start the programmed playback.

You can play a specific title or chapter repeatedly.

(Title repeat, chapter repeat, A-B repeat)

## Repeating a title

You can play the same title repeatedly.

1. While the disc is playing, press the **REPEAT DISC** button until the “**Repeat Title**” indicator displays on the screen. The current title is played repeatedly.

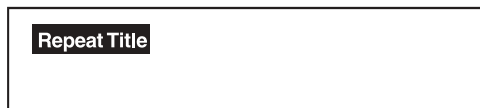

## Repeating a chapter

You can play the same chapter repeatedly.

2. While the disc is playing, press the **REPEAT DISC** button until the “**Repeat Chapter**” indicator displays on the screen. The current chapter is played repeatedly.



## To resume normal playback

3. While the disc is playing, press the **REPEAT DISC** button until the “**Off**” indicator displays on the screen.

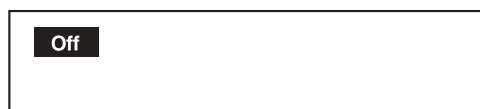

You can play a single track and whole disc repeatedly.

## Repeating a single track

You can play the same track repeatedly.

1. While the disc is playing, press the **REPEAT DISC** button until the “**Repeat Single**” indicator displays on the screen. The current track is played repeatedly.



## Repeating a whole disc

2. While the disc is playing, press the **REPEAT DISC** button until the “**Repeat All**” indicator displays on the screen. The whole disc is played repeatedly.

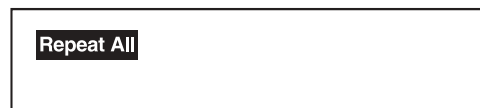

## To resume normal playback

3. Press the **REPEAT DISC** button until the “**Off**” indicator displays on the screen.



(continued on next page)

## Repeating a specific section

You can play a specific section repeatedly.

1. While the disc is playing, press the **REPEAT A-B** button at the beginning of the section (**Rep A-**) is displayed you want to play repeatedly.
2. Press the **REPEAT A-B** button again at the end of the section (**Rep A-B**) is displayed.
3. The Unit will immediately begin replaying your selection.

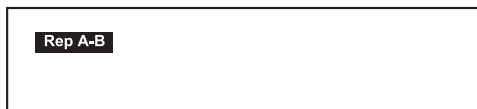

## To resume normal playback

4. While the disc is playing, press the **REPEAT A-B** button until the "**Off**" indicator displays on the screen.

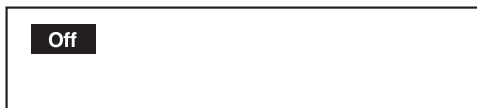

### Notes :

- A-B repeat can only be used within the same title. If the start and end of the section to be repeated are in different titles, A-B repeat is cancelled.
- The A-B repeat function does not operate in scenes where different camera angles are recorded.

# PLAYING PICTURE FILE DISC

This unit can play Picture files recorded on CD-R and CD-RW discs.

## *Playing a Picture file disc*

1. Press the **OPEN** button to open the disc door.
2. Hold the Picture disc by its sides and carefully make it fit onto the central support of compartment with the label side facing up you until you hear a “click”.
3. Push the door to close.
4. The unit will take a short while to load the disc.
5. Press the **▶PLAY** button. The next picture will automatically display after 6 seconds.

**Full-Screen  
Review**



**Thumbnail  
Review**

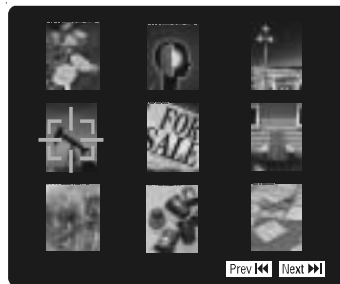

### **Notes:**

- If you press the **MENU** button on the remote in full-screen review, the Unit will display a menu of 9 thumbnail images.
- Use the **cursor** to highlight **▶▶INEXT** or **◀◀PREV** in thumbnail screen and then press the **ENTER** button to review other images. If you want to review one image in full-screen, you can use the **CURSOR** **◀**, **▶**, **▲** or **▼** buttons to highlight the image and then press the **ENTER** button to confirm. The image you selected will show on TV in Full-Screen and automatically display one by one again in about 6 seconds intervals.
- You can press the **PAUSE** button to interrupt playback, and press the **▶PLAY** button to resume playback.
- You also can use **GOTO** function or use the numbered buttons to enter the number to quickly select any image.
- You can press the **ZOOM** button to enlarge the picture in 3 levels.
- Press the **ANGLE** button on the remote control to rotate the picture orientation by 90°.



# CUSTOMIZING THE FUNCTION SETTINGS

## LANGUAGE setting

1. Press the **SETUP** button in stop mode.
2. Use **▲** or **▼** button to one language, then press the **ENTER** button. The screen will change to your selected language wordings immediately.
3. To exit the **SETUP MENU** and return to the normal screen, press the **RETURN** button.

STEP 2

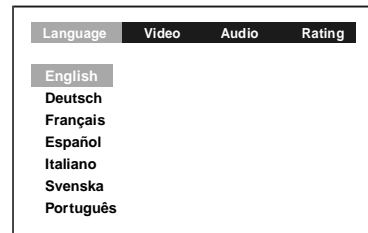

## VIDEO setting

### TV Shape

1. Press the **SETUP** button in stop mode.
2. Use **◀** or **▶** button to select **Video**, then press the **ENTER** button.
3. Use **▲** or **▼** button to select TV Shape, then press the **ENTER** button.
4. Use **▲** or **▼** button to shift and select the TV type, then press the **ENTER** button.
5. To exit the **FUNCTION SETUP MENU** and return to the normal screen, press the **RETURN** button.

STEP 2

STEP 3

STEP 4

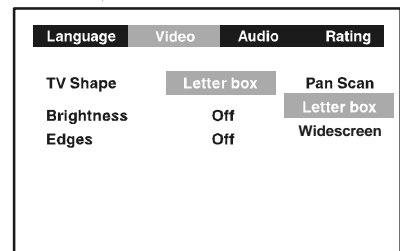
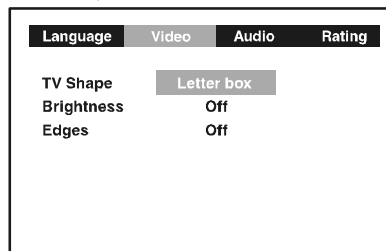
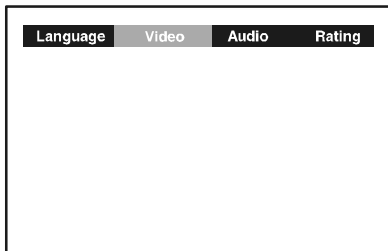

Cut off when a widescreen video image is played.

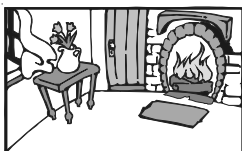
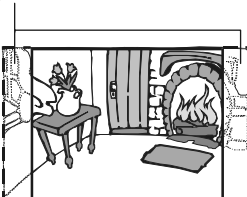

### Pan Scan

- When widescreen video material is played, this mode clips the right and left sides of the image so that it can be viewed on a conventional screen.
- Some widescreen DVDs that do not permit Pan Scan mode playback are automatically played in letterbox mode (black bands top and bottom).

### Letter Box

- When widescreen video material is played in this mode on a conventional screen, black bands appear at the top and bottom of the screen.

### Widescreen

- This is the correct mode for playing widescreen videos on a widescreen.

### Notes :

- The displayable picture size is preset on the DVD disc. Therefore the playback picture of some DVD discs may not conform to the picture size you select.
- Some DVD discs recorded in widescreen picture format, the playback picture may appear as widescreen mode regardless of the TV shape setting.
- Pan Scan, letter box and widescreen is about video signal to TV. Actual effect of LCD screen based on both screen switch position and the video setting.

# CUSTOMIZING THE FUNCTION SETTINGS

## Brightness

1. Press the **SETUP** button in stop mode.
2. Use ◀ or ▶ button to select **Video**, then press the **ENTER** button.
3. Use ▲ or ▼ button to select **Brightness**, and then press the **ENTER** button.
4. Use ▲ or ▼ button to shift and select the **Off/On**, then press the **ENTER** button.
5. If you want to exit the **SETUP MENU** and return to the normal screen, press the **RETURN** button.

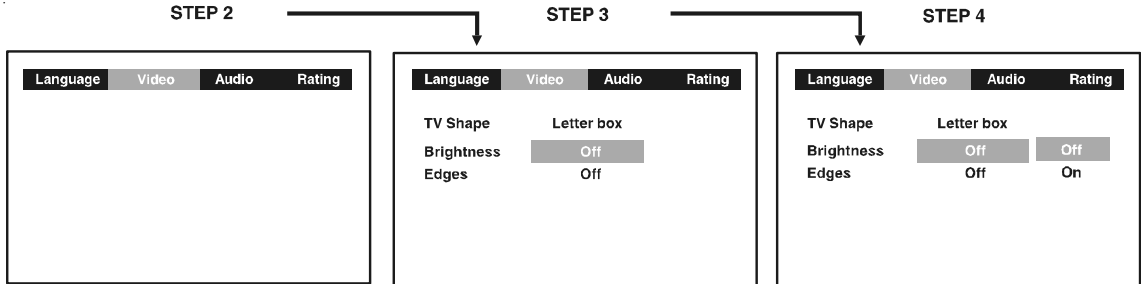

**On :** Picture will be brighter to clarify details.

**Off :** Picture will have deepened colors.

## Edges

1. Press the **SETUP** button in stop mode.
2. Use ◀ or ▶ button to select **Video**, then press the **ENTER** button.
3. Use ▲ or ▼ button to select **Edges**, and then press the **ENTER** button.
4. Use ▲ or ▼ button to shift and select the **Sharpen / Soften / Off**, then press the **ENTER** button.
5. If you want to exit the **SETUP MENU** and return to the normal screen, press the **RETURN** button.

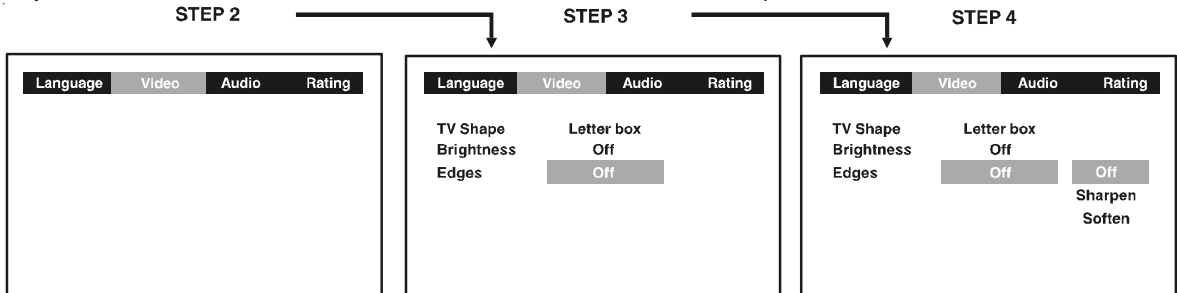

**Sharpen :** Fine detail will be easier to see.

**Soften :** Soft-focus effect.

**Off :** Picture will be returned to normal.

## AUDIO setting

### Digital Out

1. Press the **SETUP** button in stop mode.
2. Use ◀ or ▶ button to select **Audio**, press the **ENTER** button.
3. Press the **ENTER** button repeatedly to select Digital Out type.
4. To exit the **FUNCTION SETUP MENU** and return to the normal screen, press the **RETURN** button.

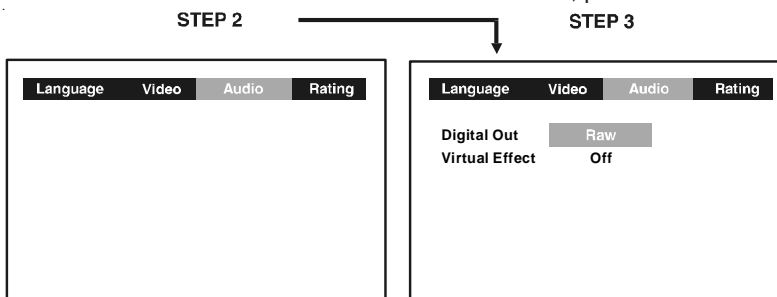

**Raw :** Use this setting when the unit is connected to an external Dolby Digital decoder.

**PCM :** Use this setting when the unit is connected to an external surround decoder or stereo.

# CUSTOMIZING THE FUNCTION SETTINGS

## Virtual Effect (for CD and DVD only)

If you want to obtain expansive virtual surround sound effects from just two speakers.

1. Press the **SETUP** button in stop mode.
2. Press ◀ or ▶ button to select **Audio**, press the **ENTER** button.
3. Press ▲ or ▼ button to select **Virtual Effect**, then press the **ENTER** button.
4. Press ▲ or ▼ button to select ON or OFF, then press the **ENTER** button.
5. Press **RETURN** button to exit SETUP MENU

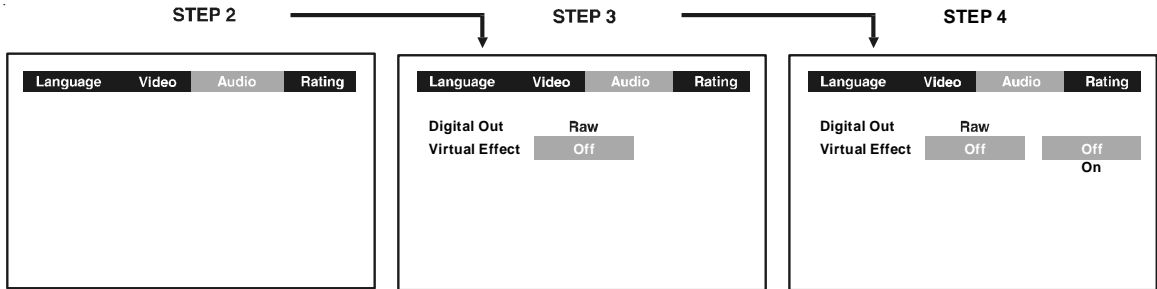

## RATING setting

### Factory Set

If you want to return the initial language setting to the factory default, do the following:

1. Press the **SETUP** button in stop mode.
2. Use ◀ or ▶ button to select the Rating, then press the **ENTER** button.
3. Use ▲ or ▼ button to shift and select the Factory Set, then press the **ENTER** button.
4. Use ▲ or ▼ button to shift and select Yes, then press the **ENTER** button.
5. To exit the SETUP MENU and return to the normal screen, press the **RETURN** button.

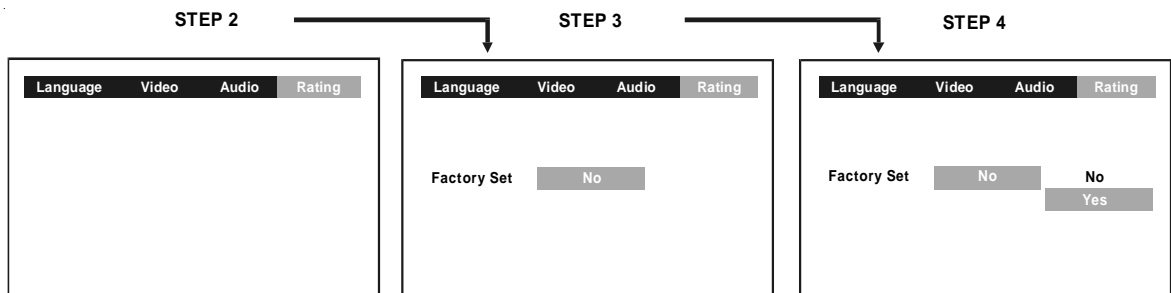

### Note:

When you reset the Unit to the factory default, the Unit will take 3-5 seconds to reset.

# LANGUAGE CODE LIST FOR DISC LANGUAGE

Code	Language Name	Code	Language Name	Code	Language Name	Code	Language Name
AA	Afar	FY	Frisian	MG	Malagasy	SL	Slovenian
AB	Abkhazian	GA	Irish	MI	Maori	SM	Samoan
AF	Afrikaans	GB	Scots Gaelic	MK	Macedonian	SN	Shona
AM	Ameharic	GL	Galician	ML	Malayalam	SO	Somali
AR	Arabic	GN	Guarani	MN	Mongolian	SQ	Albanian
AS	Assamese	GU	Gujarati	MO	Moldavian	SR	Serbian
AY	Aymara	HA	Hausa	MR	Marathi	SS	Siswat
AZ	Azerbaijani	HI	Hindi	MS	Malay	ST	Sesotho
BA	Bashkir	HR	Croatian	MT	Maltese	SU	Sundanese
BE	Byelorussian	HU	Hungarian	MY	Burmese	SV	Swedish
BG	Bulgarian	HY	Armenian	NA	Nauru	SW	Swahili
BH	Bihari	IA	Interlingua	NE	Nepali	TA	Tamil
BI	Bislama	IE	Interlingue	NL	Dutch	TE	Telugu
BN	Bengali	IK	Inupiak	NO	Norwegian	TG	Tajik
	Bangla	IN	Indonesian	OC	Occitan	TH	Thai
BO	Tibetan	IS	Icelandic	OM	(Afan) Oromo	TI	Tigrinya
BR	Breton	IT	Italian	OR	Oriya	TK	Turkmen
CA	Catalan	IW	Hebrew	PA	Panjabi	TL	Tagalog
CO	Corsican	JA	Japanese	PL	Polish	TN	Setswana
CS	Czech	JI	Yiddish	PS	Pashto, Pushto	TO	Tonga
CY	Welsh	JW	Javanese	PT	Portuguese	TR	Turish
DA	Danish	KA	Georgian	QU	Quechua	TS	Tsonga
DE	German	KK	Kazakh	RM	Rhaeto- Romance	TT	Tatar
DZ	Bhutani	KL	Greenlandic	RN	Kirundi	TW	Twi
EL	Greek	KM	Cambodian	RO	Romanian	UK	Ukrainian
EN	English	KN	Kannada	RU	Russian	UR	Urdu
EO	Esperanto	KO	Korean	RW	Kinyarwanda	UZ	Uzbek
ES	Spanish	KS	Kashmiri	SA	Sanskrit	VI	Vietnamese
ET	Estonian	KU	Kurdish	SD	Sindhi	VO	Volapük
EU	Basque	KY	Kirghiz	SG	Sangho	WO	Wolof
FA	Persian	LA	Latin	SH	Serbo- Croatian	XH	Xhosa
FI	Finnish	LN	Lingala	SI	Singhalese	YO	Yoruba
FJ	Fiji	LO	Laothian	SK	Slovak	ZH	Chinese
FO	Faroese	LT	Lithuanian			ZU	Zulu
FR	French	LV	Latvian, Lettish				

# MAINTENANCE

## ***Cleaning Disc***

A defective or soiled disc inserted into the unit can cause sound to drop out during playback.

Handle the disc by holding its inner and outer edges.

- Do NOT touch the surface of the unlabeled side of the disc.
- Do NOT stick paper or tape on the surface.
- Do NOT expose the disc to direct sunlight or excessive heat.
- Clean the disc before playback. Wipe the disc from the center outward with a cleaning cloth.
- NEVER use solvents such as benzine or alcohol to clean the disc.
- Do NOT use irregular shape discs (example : heart shaped, octagonal, etc.). They may cause malfunctions.

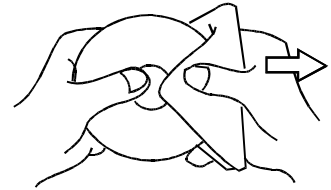

## ***Cleaning the unit***

- Be sure to turn the unit off and disconnect the AC power cord before maintaining the unit.
- Wipe the unit with a dry soft cloth.  
If the surfaces are extremely dirty, wipe clean with a cloth which has been dipped in a weak soap-and-water solution and wrung out thoroughly, then wipe with a dry cloth.
- Never use alcohol, benzine, thinner, cleaning fluid or other chemicals. Do NOT use compressed air to remove dust.

## ***Important Note***

Before transporting the unit, remove disc from the disc compartment.

# TROUBLE SHOOTING GUIDE

## SYMPTOM

## CAUSE (AND REMEDY)

No power.

- Check that the AC adaptor and AC power cord is connected.
- You cannot turn on the unit.

The remote does not function.

- Remove any obstacles between the remote and the unit.
- Use the remote near the unit.
- Point the remote at the remote sensor on the unit.
- Replace all the batteries in the remote with new ones.

## DVD

No sound or only a very low-level sound is heard.

- Make sure that you've select DVD mode.
- The system is in pause mode or in Slow-motion Play mode. Press the ► **PLAY** button to return to normal play mode.
- Fast forward or fast reverse is performed. Press the ► **PLAY** button to return to normal play mode.
- Make sure that AUDIO output and AV IN input connections are correct.
- The DTS DVD disc cannot be decoded to have speaker output.
- This unit is too hot, shut off the unit for 30 minutes to cool down.

No picture

- The region number of the disc doesn't match the region number of this unit.



- The function is not select DVD mode, ensure select DVD of AV IN/DVD switch.

The picture is not clear

- Clean the disc.
- The disc is scratched.

Severe hum or noise is heard.

- The plugs and jacks are dirty. Wipe them with a cloth slightly moistened with alcohol.
- Clean the disc.

The disc does not play.

- There is no disc inside ("No Disc" appears on the screen).
- Insert the disc correctly with the playback side facing toward you.
- Clean the disc.
- A non-NTSC disc has been inserted. The unit and disc region number are incompatible.
- Condensation may have formed inside the unit due to a sudden change in temperature. Wait about an hour for it to clear and try again.

## Need More Help?

**DO NOT RETURN THIS TO THE STORE**

**Please call Customer Service at 1-800-252-6123 (ET)  
or visit online help at <http://www.1800customersupport.com>**

# CARRYING BAG INSTALLATION

1. Insert the unit into bag as shown.

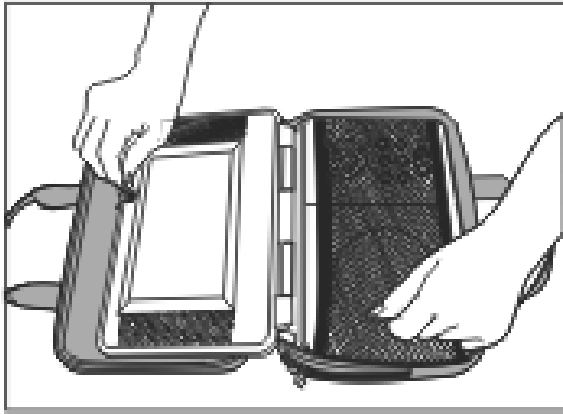

4. Take another strap and hook up the upper headrest of the driver's seat as shown.

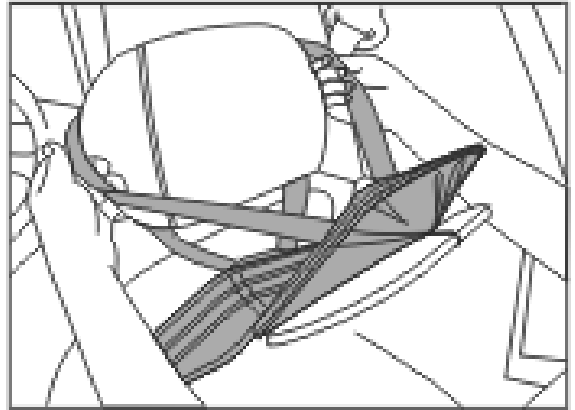

2. Insert the straps on carrying bag as shown.

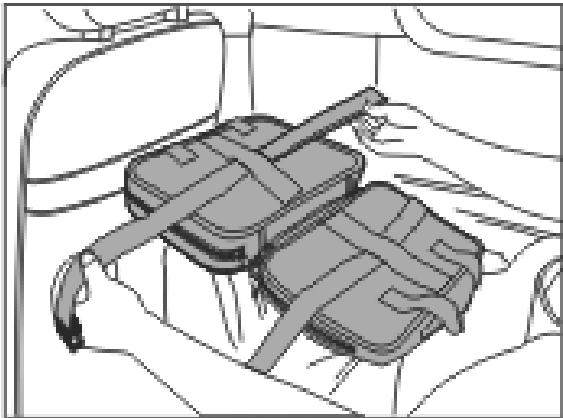

5. Take loop elastic band to around the headrest of the driver's seat and unit as shown.

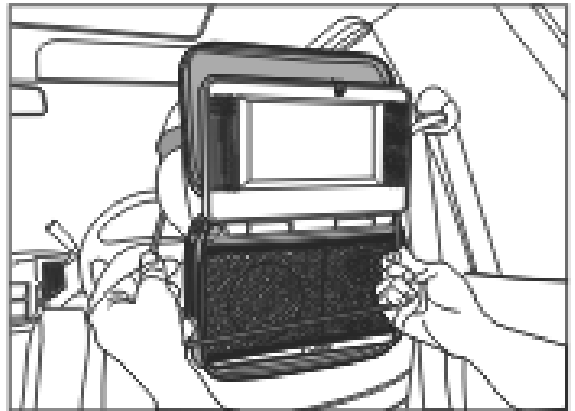

3. Take straps and hook up the neck headrest of the driver's seat as shown.

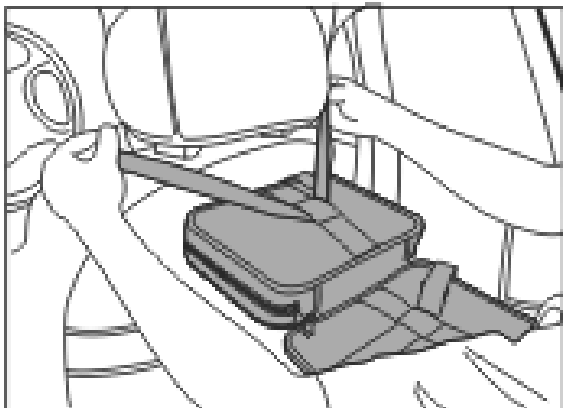

6. Adjust the straps tightly so that the unit is secured.

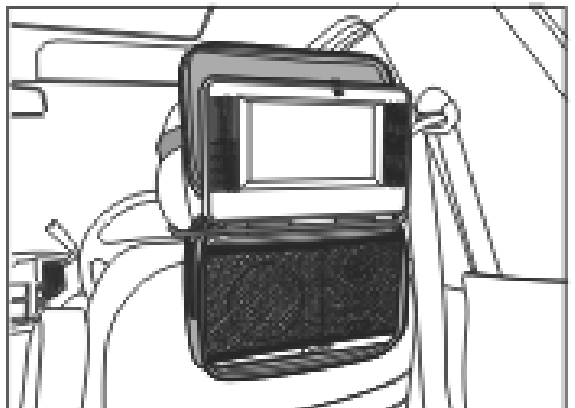

# GAME PAD (CONNECTIONS)

## Connecting the Video game system

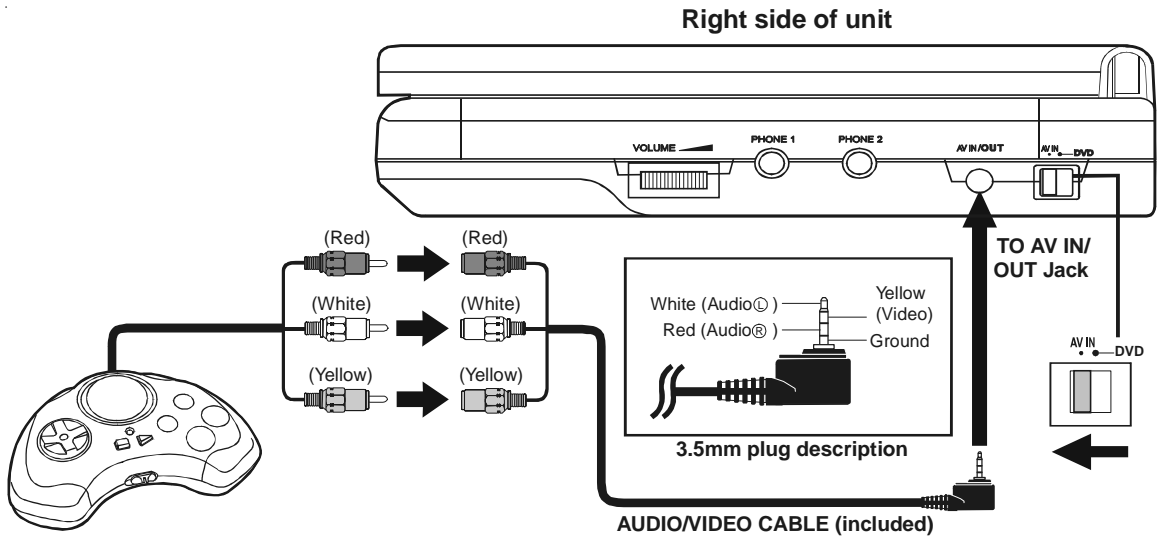

## Playing a Video game system

1. Turn on the unit, slide the **FUNCTION** button to select "AV IN".
2. Turn on the video game system and follow the instructions provided with it to play game.



## Free Manuals Download Website

<http://myh66.com>

<http://usermanuals.us>

<http://www.somanuals.com>

<http://www.4manuals.cc>

<http://www.manual-lib.com>

<http://www.404manual.com>

<http://www.luxmanual.com>

<http://aubethermostatmanual.com>

Golf course search by state

<http://golfingnear.com>

Email search by domain

<http://emailbydomain.com>

Auto manuals search

<http://auto.somanuals.com>

TV manuals search

<http://tv.somanuals.com>