



THE TOOL COMPANY

# CORDLESS HAMMER DRILLS

■ STOCK No. 63121  
63122

■ PART No. CDH120V  
CDH140V

## • INSTRUCTIONS •

**IMPORTANT:** PLEASE READ THESE INSTRUCTIONS CAREFULLY TO ENSURE THE SAFE AND EFFECTIVE USE OF THIS TOOL.



## GENERAL INFORMATION

This manual has been compiled by Draper Tools and is an integrated part of the power tool equipment, which should be kept with the machine.

This manual describes the purpose for which this tool has been designed and contains all the necessary information to ensure its correct and safe use. We recommend that this manual is read before any operation of the machine, before performing any kind of adjustment to the machine, and prior to any maintenance tasks. By following all the general safety instructions contained in this manual, it will ensure both machine and operator safety, together with longer life of the tool itself.

All photographs and drawings in this manual are supplied by Draper Tools to help illustrate the operation of the machine.

Whilst every effort has been made to ensure accuracy of information contained in this manual, the Draper Tool policy of continuous improvement determines the right to make modifications without prior warning.



THE TOOL COMPANY

# CORDLESS DRILLS

■ STOCK No.63121. ■ PART No.CDH120V.  
63122. CDH140V.

**CONTENTS:**

Page No.

Specification/Guarantee .....2

Power Supply .....3

General Safety Instructions for Power Tools .....4

Added Safety Instructions for Cordless Power Tools .....5

Unpacking and Checking Contents .....6

Getting to know Your Cordless Drill/Charger .....7

Operation and Use/Batteries .....8-10



## DECLARATION OF CONFORMITY

We  
Draper Tools Ltd. Hursley Road, Chandler's Ford, Eastleigh, Hampshire.  
SO53 1YF. England.

Declare under our sole responsibility that the product:

**Stock Nos:-** CDH120V & CDH140V.

**Part Nos:-** 63121 & 63122.

**Description:-** Cordless Hammer Drill.

To which this declaration relates is in conformity with the following directive(s)  
73/23/EEC & 89/336/EEC.

JOHN DRAPER  
Managing Director

08/2000



# SPECIFICATION

Whilst every effort has been made to ensure accuracy of information given in this manual is correct at the time of going to print, the Draper Tools policy of continuous improvement determines the right to change specification without notice.

Part No. ....	CDH120V .....	CDH140V .....
Stock No. ....	63121 .....	63122 .....
Battery pack .....	1 x 12V D.C .....	1 x 14.4V D.C .....
Speed .....	0-400/0-1250rpm .....	0-400/0-1250rpm .....
Impact blows per min.....	16,000 max. ....	16,000 max. ....
Chuck capacity .....	10mm .....	10mm .....
Spindle thread.....	$\frac{3}{8}$ " x 24UNF .....	$\frac{3}{8}$ " x 24UNF .....
Drilling capacities:		
Wood .....	16mm .....	20mm .....
Mild steel .....	10mm .....	10mm .....
Masonry .....	10mm .....	10mm .....
Max. torque .....	125kgf-cm .....	130kgf-cm .....
Charging time .....	1 hr approx .....	1 hr approx. ....
Charger input voltage .....	240V/50Hz.....	240V/50Hz .....
Weight - machine only .....	1.9kg. ....	2.0kg. ....
Sound power level.....	79.2dB(A) .....	79.2dB(A) .....
Sound pressure level.....	92.2dB(A) .....	92.2dB(A) .....
Vibration level.....	1.38m/s <sup>2</sup> .....	1.38m/s <sup>2</sup> .....



# GUARANTEE

Draper tools have been carefully tested and inspected before shipment and are guaranteed to be free from defective materials and workmanship for a period of 12 months from the date of purchase.

Should the machine develop any fault, please return the complete tool to your distributor or contact Draper Tools Limited, Chandler's Ford, Eastleigh, Hampshire, SO53 1YF England.

Telephone **(023) 8026 6355**.

If upon inspection it is found that the fault occurring is due to defective materials or workmanship repairs will be carried out free of charge. This guarantee does not apply to normal wear and tear, nor does it cover any damage caused by misuse, careless or unsafe handling, alterations, accident, or repairs attempted or made by any personnel other than the authorized Draper warranty repair agent.

This guarantee applies in lieu of any other guarantee expressed or implied and variations of its terms are not authorised.

Your Draper guarantee is not effective unless you produce a dated receipt or invoice to verify your proof of purchase within the 12 month period.



Please note that this guarantee is an additional benefit and does not affect your statutory rights.

Draper Tools Limited.

Note: This tool is intended for domestic use only.

# POWER SUPPLY

## CONNECTING YOUR MACHINE TO THE POWER SUPPLY: (240V)

To eliminate the possibility of an electric shock your machine has been fitted with a BS approved, non rewirable moulded plug and cable which incorporates a fuse, the value of which is indicated on the pin face of the plug. Should the fuse need to be replaced an  approved BS1362 fuse must be used of the same rating, marked thus .

The fuse cover is detachable, never use the plug with the cover omitted. If a replacement fuse cover is required, ensure it is of the same colour as that visible on the pin face of the plug (i.e. red). Fuse covers are available from your Draper Tools stockist. If the fitted plug is not suitable, it should be cut off and destroyed. \*The end of the cable should now be suitably prepared and the correct type of plug fitted. See below.

### \*WARNING:

A plug with bare flexible wires exposed is hazardous if engaged in a live power socket outlet.

### WARNING: THIS APPLIANCE IS DOUBLE INSULATED.

Blue – Neutral, Brown – Live.

As these colours may not correspond with the coloured markings identifying the terminals in your plug, proceed as follows:

The wire which is coloured blue must be connected to the terminal which is marked with the letter 'N' or coloured black or blue.

The wire which is coloured brown must be connected to the terminal which is marked with the letter 'L' or coloured red or brown.

Ampere rating (on Name plate)	3	6	10	13
Extension cable length	Wire Size mm <sup>2</sup>			
7.5m	0.75	0.75	1.0	1.25
15m	0.75	0.75	1.0	1.5
22.5m	0.75	0.75	1.0	1.5
30m	0.75	0.75	1.25	1.5
45m	0.75	1.25	1.5	2.5

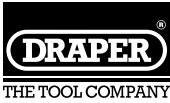

# GENERAL SAFETY INSTRUCTIONS FOR POWER TOOLS

## WARNING

Please read the following instructions carefully, failure to do so could lead to serious personal injury.

## IMPORTANT

Draper Tools Limited recommends that this machine should not be modified or used for any application other than that for which it was designed. If you are unsure of its relative applications do not hesitate to contact us in writing and we will advise you.

### 1. KNOW YOUR POWER TOOL

Read and understand the owner's manual and labels affixed to the tool. Learn its application and limitations as well as the specific potential hazards peculiar to this tool.

### 2. KEEP WORK AREA CLEAN

Cluttered areas and benches invite accidents. Floors must not be slippery due to oil or sawdust.

### 3. AVOID DANGEROUS ENVIRONMENTS

Do not use power tools in damp or wet locations, or expose them to rain. Keep work area well lit. Provide adequate space surrounding the work area. Do not use in environments with a potentially explosive atmosphere.

### 4. KEEP CHILDREN AWAY

All visitors should be kept a safe distance from work area.

### 5. STORED TOOLS

When not being used, all tools should be stored in a dry, locked cupboard or out of the reach of children.

### 6. WEAR PROPER CLOTHING

Do not wear loose clothing, neckties or jewellery (rings, wristwatches) to catch in moving parts. NONSLIP footwear is recommended. Wear protective hair covering to contain long hair. Roll long sleeves above the elbow.

### 7. USE SAFETY GOGGLES (Head Protection)

Wear CE approved safety goggles at all times. Normal spectacles only have impact resistant lenses, they are NOT safety glasses. Also, use face or dust mask if application is dusty and ear protectors (plugs or muffs) during extended periods of operation.

### 8. NOISE LEVELS

Some types of machines may have high noise levels when working. In such cases ear protection must be worn.

### 9. VIBRATION LEVELS

Hand held power tools produce different vibration levels. You should always refer to the specifications and relevant Health and Safety guide.

### 10. DUST EXTRACTION

If your tool is fitted with a dust extraction fitting, always ensure that it is connected and being used with a dust extractor. Vacuum cleaners can be used if suitable for the material being extracted.

### 11. PROTECT YOURSELF FROM ELECTRIC SHOCK

When working with power tools, avoid contact with any earthed items (e.g. pipes, radiators, hobs and refrigerators, etc.). If you are using a power tool in extreme conditions (e.g. high humidity or generating metal dust), always use an RCD (residual current device) at the power socket.

### 12. STAY ALERT

Always watch what you are doing and use common sense. Do not operate a power tool when you are tired or under the influence of alcohol or drugs.

### 13. WHEN WORKING OUT OF DOORS

Only use extension leads designed for that purpose.

### 14. ACCESS TO MAINS SOCKET

If a stationary machine is fitted with a moulded plug and cable, the machine should not be positioned so that access to the mains socket is restricted.

### 15. DISCONNECT POWER TO THE TOOL

When not in use, before servicing and when changing accessories such as cutters, etc.

### 16. AVOID ACCIDENTAL STARTING

Make sure the switch is in the OFF position before plugging the machine into the power supply.

### 17. NEVER LEAVE MACHINE RUNNING UNATTENDED

Turn power off. Do not leave machine until it comes to a complete stop.

### 18. DO NOT ABUSE THE CORD

Never carry the tool by the power cable or pull it from the socket. Keep the power cable away from heat, oil and sharp edges.

### 19. NEVER STAND ON TOOL

Serious injury could occur if the tool is tipped or if the cutting tool is accidentally contacted. Do not store materials above or near the tool, so that it is necessary to stand on the tool to reach them.

### 20. CHECK DAMAGED PARTS

Check for damage to parts, breakage of parts, mountings and any other conditions that may affect its operation. A guard or other part that is damaged should be properly repaired or replaced.

### 21. KEEP GUARDS IN PLACE

And in working order.

### 22. MAINTAIN TOOLS WITH CARE

Keep tools sharp and clean for the best and safest performance. Follow instructions for lubricating and changing accessories. All extension cables must be checked at regular intervals and replaced if damaged. Always keep the hand grips on the tool clean, dry and free of oil and grease.

### 23. USE RECOMMENDED ACCESSORIES

Consult the owners manual for recommended accessories. Follow the instructions that accompany the accessories. The use of improper accessories may cause hazards.

### 24. REMOVE ADJUSTING KEYS AND WRENCHES

Form a habit of checking to see that keys and adjusting wrenches are removed from the tool before turning it on.

### 25. SECURE WORK

Use clamps or a vice to hold work. This frees both hands to operate the tool.

### 26. DO NOT OVERREACH

Keep proper footing and balance at all times.

### 27. USE RIGHT TOOL

Do not force the tool or attachment to do a job for which it was not designed.

### 28. DO NOT FORCE TOOL

It will do the job better and safer at the rate for which it was designed.

### 29. DIRECTION OF FEED

Feed work into a blade or cutter against the direction of rotation of the blade or cutter only.

### 30. WHEN DRILLING OR SCREWING INTO WALLS

Always make sure there is no danger of hitting any hidden power cables, water or gas pipes in the wall.

## IMPORTANT NOTE

**Residual Risk.** Although the safety instructions and operating manuals for our tools contain extensive instructions on safe working with power tools, every power tool involves a certain residual risk which can not be completely excluded by safety mechanisms. Power tools must therefore always be operated with caution !



## ADDED SAFETY INSTRUCTIONS FOR CORDLESS POWER TOOLS

Safety is a combination of operator common sense and alertness at all times when the drill is being used.

### WARNING

For your own safety do not attempt to use your drill until the battery is fully charged. Remember the drill is always in an operating condition as it does not need to be connected to a power supply. When not in use place the direction of rotation switch in the neutral position. Before drilling check that there are no hidden hazards such as electrical cables, water or gas pipes running below the surface - use a metal/voltage detector. Do not expose either the drill or charger to rain or water. Do not overcharge the battery (more than 6 hours) as this could damage the battery cells.

### HEALTH AND SAFETY FOR BATTERIES

**General:** Do not put in fire or mutilate - cells may burst or release toxic materials. Do not short circuit cells, may cause burns.

### DISPOSAL

Do not mutilate batteries, corrosive electrolyte will be released. Do not incinerate - danger of explosion and release of toxic fumes. Do not dispose of batteries or cells in a charged condition. Expired nickel-cadmium batteries must be recycled/disposed of in accordance with the appropriate regulations or legislation. They should be returned to your local warranty agent/stockist.



---

**DRAPER HELPLINE: (023) 8049 4344**

---

## UNPACKING AND CHECKING CONTENTS

### WARNING:

For your own safety, never connect the plug to the power supply until all the assembly steps have been completed and you have read and understood the safety and operating instructions.

### FIG.A

- ① Cordless hammer drill.
- ② Battery charger complete with BS approved moulded plug and cable.
- ③ Battery pack.
- ④ Carrying case.



Carefully unpack the storage case and its contents from the carton. Place the storage box on a flat level surface. Now open the lid by releasing the two catches which are located at the front of the case. Referring to Fig.A, carefully check that all the parts are present.

If any parts are missing or damaged please contact the stockist where your purchase was made or call the Draper Helpline on (023) 8049 4344.

# GETTING TO KNOW YOUR CORDLESS DRILL/CHARGER

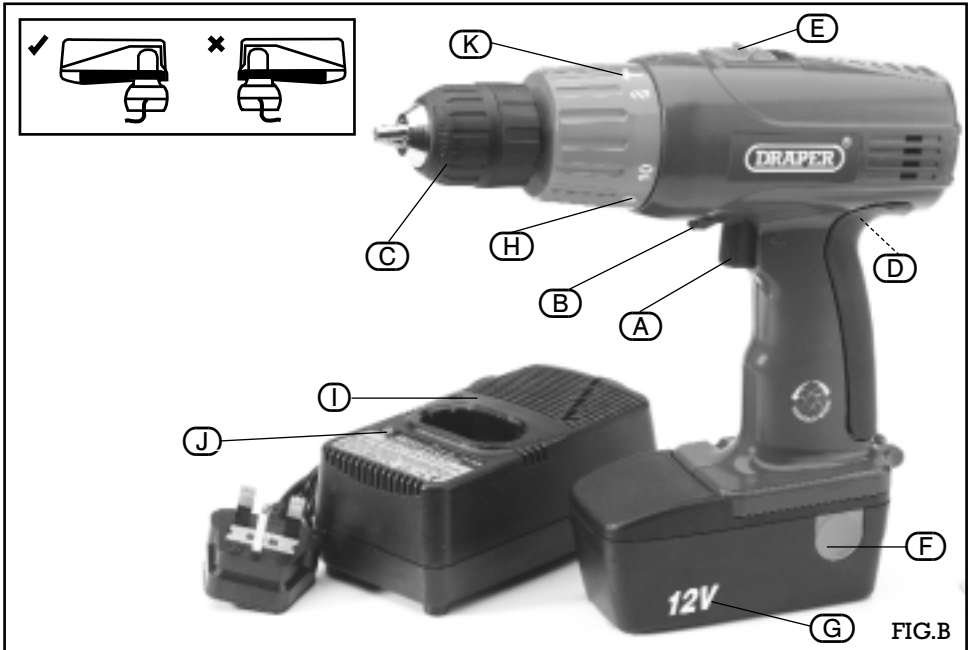

- (A) **TRIGGER** - When the variable speed switch trigger is depressed the chuck will rotate (providing the direction switch is in a clockwise or anticlockwise position).
- (B) **FORWARD/REVERSE LEVER** - This lever determines the direction of rotation of the chuck, i.e. clockwise or anticlockwise.
- (C) **KEYLESS CHUCK** - This is for holding tools, i.e. drill bits or screwdriver bits.
- (D) **RATING PLATE** - Shows Part No., voltage, capacity, etc.
- (E) **TWO-SPEED GEARBOX SELECTOR SWITCH** - This adjusts the rotation speed range of the chuck via the two-speed gearbox. (NOTE: Only change gear when the drill has completely stopped).
- (F) **BATTERY RELEASE** - To release the battery pack, squeeze the grips located on either side of the battery casing and carefully slide it out.
- (G) **BATTERY PACK** - This is the drill's power supply.
- (H) **TORQUE CONTROL** - There are 11 torque settings, settings 1-10 are normally used for hammer action. The eleventh setting is for standard drilling.
- (I) **BATTERY CHARGER** - Charges the battery in approximately 1 hour.
- (J) **CHARGING INDICATOR** - This will glow when the battery is charging.
- (K) **HAMMER SETTING** - Select this setting for hammer drilling into brickwork/masonry.



# OPERATION AND USE

## BATTERY CHARGING

To charge the battery pack it must first be removed from the drill. To release the battery pack squeeze the grips located on either side of the battery casing and gently pull the battery pack from the housing (fig.1).

Plug the battery charger unit into a 13 amp, three-pin socket. Place the battery in the charger as shown in (fig.2). Making sure the + and - on the battery line up with the + and - on the charger (+ T0 +, - T0 -). Do not force. Ensure the battery is inserted correctly. The indicator light on the charger will now glow to show that the battery is charging (fig.3). When the battery is fully charged the light will go out (approx. 1 hour). The battery pack can then be removed and used to power the tool. To refit the battery pack to the drill push firmly until the battery pack locates and snaps into place.

**NOTE:** The battery was discharged after manufacturing and will therefore require five to ten charges/discharges before it reaches its full capacity.

## INSTALLING AND REMOVING BITS

This drill is fitted with a keyless chuck, this means that a chuck key is not required to secure the drill or screwdriver bit. Place the drill or screwdriver bit into the chuck as far as it will go, then hand tighten. Short screwdriver bits need only be inserted to the depth of the hexagon shank before tightening the chuck by hand. Alternatively grip part (A) of the chuck, (fig.4) and slowly run the drill clockwise until the chuck grips the bit, then hand tighten.

## DIRECTION SWITCH

This switch determines the direction of rotation of the chuck, i.e. clockwise or anticlockwise.

To alter the direction of rotation stop the drill and push (E), (fig.5), switch to the left or right. When the direction switch is in the 'F' (forward) position the chuck will rotate clockwise when viewed from the handle end of the drill. When the switch is in the 'R' (reverse) position the chuck will rotate anticlockwise when viewed from the handle. Before operation check that the switch is set in the required position. Do not change the direction of rotation until the chuck comes to a complete stop.

When the drill is not in use move the direction switch to the neutral position (the middle setting).

Fig.1.

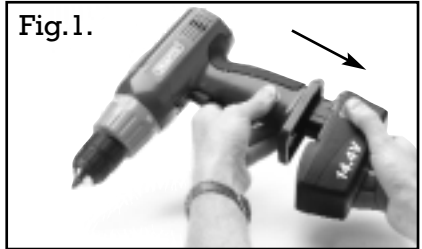

Fig.2.

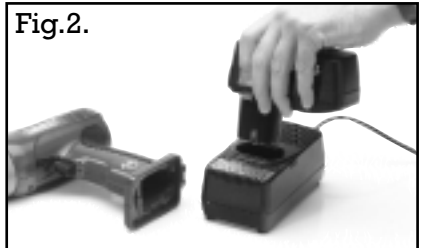

Fig.3.



Fig.4.

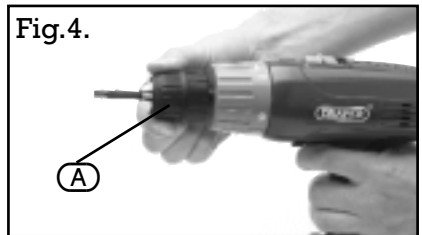
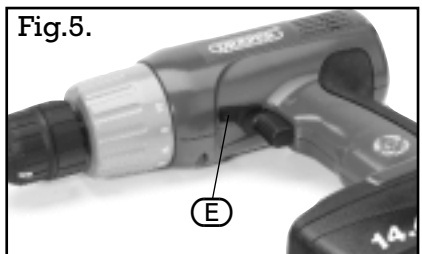

Fig.5.



## OPERATION AND USE

### CHANGING SPEEDS

To change the speed of the chuck, push the two-speed gearbox selection switch (B), (fig. 6 and 7) forwards for low speed, or backwards for high speed.



**IMPORTANT:** ONLY CHANGE SPEED WHEN THE MACHINE IS STOPPED.

### TRIGGER

When the trigger is depressed the chuck will rotate (provided the direction switch is set in the forward or reverse position). This trigger switch is electronic which enables the user to vary the speed continuously in both gears. The speed varies according to how far the trigger switch is depressed, the further it is depressed the faster the chuck will rotate and the lighter it is depressed, the slower it will rotate.

### TORQUE CONTROL

By turning the collar (C), (fig.8) it is possible to adjust the amount of torque.

In the "twist drill" setting , (fig.8), the drill has full torque. In the "hammer" setting  the hammer action is engaged.

Settings 1-10 can be used in either gear and provide a facility for setting the torque to the required level. For example this means that repetitive driving of screws of the same size will be driven into the material to the same torque, thus giving the same fixing strength, or in the case of countersunk screws, these will all be driven to the same depth in the material.

The torque control helps to prevent the heads of small diameter screws being twisted off when correctly set.

### HOLDING THE DRILL

The drill casing is designed to be held comfortably in two ways.

1. By the handle (fig.9).
2. Or, by the in-line support grip (fig.10).

Fig.6.

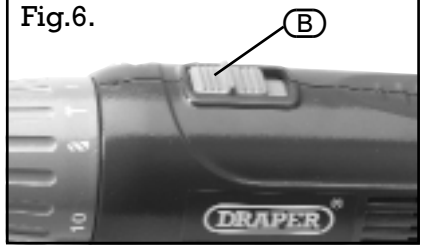

Fig.7.

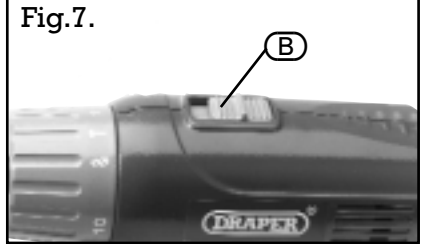

Fig.8.

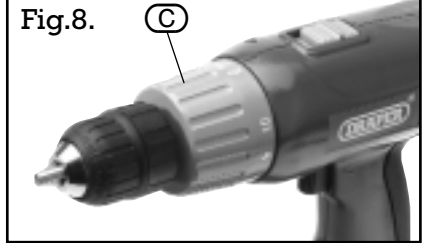

Fig.9.



Fig.10.





## OPERATION AND USE

### DRILLING WOOD AND PLASTIC

To prevent splitting around the drill holes on the reverse side, place a piece of scrap timber under the material to be drilled.

### DRILLING MASONRY

Start drilling at a low speed to prevent the drill bit from wandering. Once penetration is achieved fully depress the trigger to achieve maximum speed and hammer power.

### DRILLING METAL

Metals such as sheet steel, aluminium and brass may be drilled. Mark the point to be drilled with a punch or nail to help the drill bit tip to locate.

### SCREWDRIVING

To prevent slip or damage to the screwhead, match the screwdriver bit to the screw-head size. To remove screws move the direction switch to the reversing position and apply pressure to the screwhead and depress the trigger slowly.

### MAINTENANCE

Neither the drill or charger require any special maintenance.

Keep both the drill and the charger in a dry place where they will not be exposed to frost or direct sunlight.



## BATTERIES

### STOCK Nos:

54452

54453

### PART Nos:

CB12

CB14

### VOLTAGES

12V

14.4V

---

**IMPORTANT:** Please note all repairs/adjustments should be carried out by a qualified person.

---

**DRAPER HELPLINE: (023) 8049 4344**

---

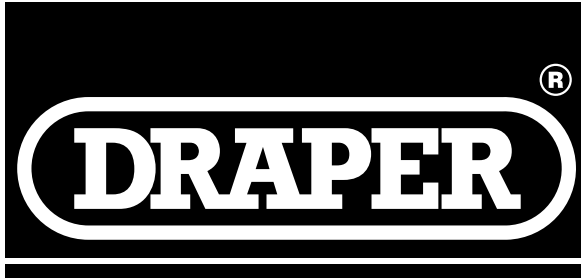

## THE TOOL COMPANY

### **DRAPER TOOLS LIMITED,**

Hursley Road, Chandler's Ford, Eastleigh, Hants. SO53 1YF. U.K.

Helpline: (023) 8049 4344.

Sales Desk: (023) 8049 4333.

General Enquiries: (023) 8026 6355.

Fax: (023) 8026 0784.



[www.draper.co.uk](http://www.draper.co.uk)

e-mail: [sales@draper.co.uk](mailto:sales@draper.co.uk)

YOUR DRAPER STOCKIST

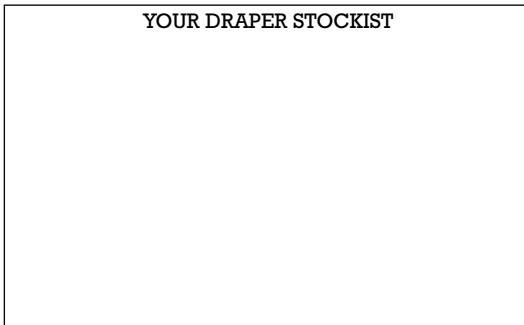

©Published by Draper Tools Ltd.

No part of this publication may be reproduced, stored in a retrieval system or transmitted in any form or by any means, electronic, mechanical photocopying, recording or otherwise without prior permission in writing from Draper Tools Ltd.

## Free Manuals Download Website

<http://myh66.com>

<http://usermanuals.us>

<http://www.somanuals.com>

<http://www.4manuals.cc>

<http://www.manual-lib.com>

<http://www.404manual.com>

<http://www.luxmanual.com>

<http://aubethermostatmanual.com>

Golf course search by state

<http://golfingnear.com>

Email search by domain

<http://emailbydomain.com>

Auto manuals search

<http://auto.somanuals.com>

TV manuals search

<http://tv.somanuals.com>